

PART NO.	A99018-025	REV	ECO	DATE	APP
		A	97774	07-15-11	TLM

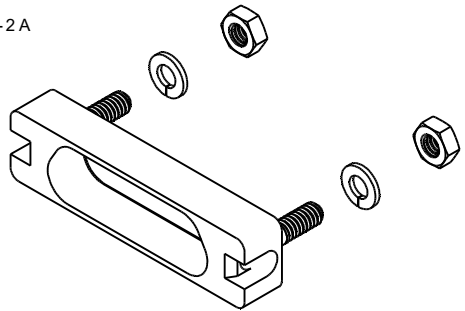

KIT CONSISTS OF:

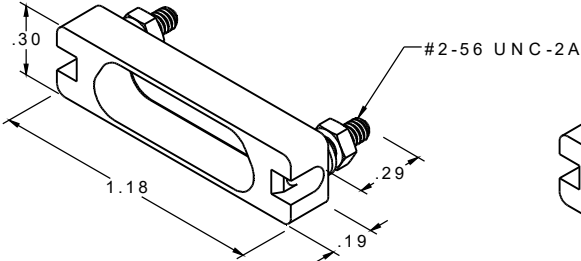
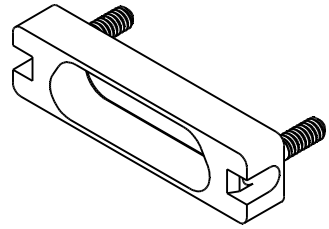

1 EA MICRO-D LATCH RECEPTACLE (D6097-025)



2 EA LOCKING WASHER (D5377-001)



2 EA #2-56 NUT (D5376-001)

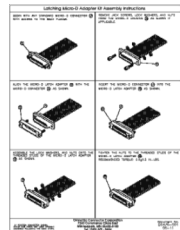

1 EA INSTRUCTION SHEET (D6476-001)

THIRD ANGLE	
-TOLERANCES-	
UNLESS OTHERWISE NOTED:	
DIMENSIONS IN INCHES	
2 PL DEC ± .01	
3 PL DEC ± .005	
4 PL DEC ± .0005	
ANGLES ± 1°	

DFTM. DGJ	DATE	06-22-11
CHK'D.	DATE	
APP'D.	DATE	

TITLE:	(25) LATCHING MICRO-D CONVERSION KIT HARDWARE
--------	---

OMNETICS
CONNECTOR CORPORATION
7260 COMMERCE CIRCLE EAST
MINNEAPOLIS, MN 55432
WWW.OMNETICS.COM

CAGE CODE	61873
DWG NO.	A99018-025
SHEET 1 OF 1	REV A
SCALE:	2:1

SLDW