

# NTLJF3118N

## Power MOSFET and Schottky Diode

20 V, 4.6 A, N-Channel, with 2.0 A Schottky Barrier Diode, 2x2 mm WDFN Package



ON Semiconductor®

[www.onsemi.com](http://www.onsemi.com)

### Features

- WDFN 2x2 mm Package Provides Exposed Drain Pad for Excellent Thermal Conduction
- Footprint Same as SC-88 Package
- 1.8 V  $V_{GS}$  Rated  $R_{DS(on)}$
- Low Profile (< 0.8 mm) for Easy Fit in Thin Environments
- Low  $V_F$  2 A Schottky Diode
- This is a Pb-Free Device

### Applications

- DC-DC Boost/Buck Converter
- Low Voltage Hard Disk DC Power Source

### MAXIMUM RATINGS ( $T_J = 25^\circ\text{C}$ unless otherwise noted)

Parameter	Symbol	Value	Unit	
Drain-to-Source Voltage	$V_{DSS}$	20	V	
Gate-to-Source Voltage	$V_{GS}$	$\pm 12$	V	
Continuous Drain Current (Note 1)	Steady State	$T_A = 25^\circ\text{C}$	3.8	A
		$T_A = 85^\circ\text{C}$	2.8	
		$t \leq 5$ s	$T_A = 25^\circ\text{C}$	
Power Dissipation (Note 1)	Steady State	$T_A = 25^\circ\text{C}$	1.5	W
		$t \leq 5$ s	2.2	
Continuous Drain Current (Note 2)	Steady State	$T_A = 25^\circ\text{C}$	2.6	A
		$T_A = 85^\circ\text{C}$	1.9	
Power Dissipation (Note 2)	Steady State	$T_A = 25^\circ\text{C}$	0.7	W
Pulsed Drain Current	$t_p = 10$ $\mu\text{s}$	$I_{DM}$	18	A
Operating Junction and Storage Temperature	$T_J, T_{STG}$	-55 to 150		$^\circ\text{C}$
Source Current (Body Diode)	$I_S$	1.8		A
Lead Temperature for Soldering Purposes (1/8" from case for 10 s)	$T_L$	260		$^\circ\text{C}$

Stresses exceeding those listed in the Maximum Ratings table may damage the device. If any of these limits are exceeded, device functionality should not be assumed, damage may occur and reliability may be affected.

1. Surface Mounted on FR4 Board using 2 in sq pad size (Cu area = 1.127 in sq [2 oz] including traces).
2. Surface Mounted on FR4 Board using the minimum recommended pad size.

### MOSFET

$V_{(BR)DSS}$	$R_{DS(on)}$ Max	$I_D$ Max
20 V	65 m $\Omega$ @ 4.5 V	3.8 A
	85 m $\Omega$ @ 2.5 V	2.0 A
	120 m $\Omega$ @ 1.8 V	1.7 A

### SCHOTTKY DIODE

$V_R$ Max	$V_F$ Typ	$I_F$ Max
20 V	0.41 V	2.0 A

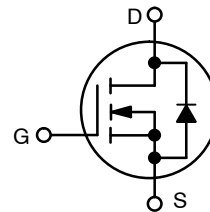

N-CHANNEL MOSFET



SCHOTTKY DIODE



WDFN6 CASE 506AN

### MARKING DIAGRAM

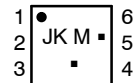

- JK = Specific Device Code
- M = Date Code
- = Pb-Free Package

(Note: Microdot may be in either location)

### PIN CONNECTIONS

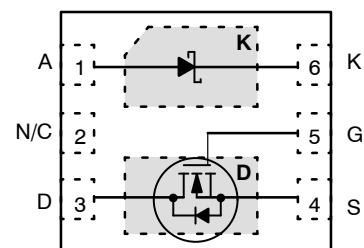

(Top View)

### ORDERING INFORMATION

See detailed ordering and shipping information on page 3 of this data sheet.

# NTLJF3118N

## SCHOTTKY DIODE MAXIMUM RATINGS ( $T_J = 25^\circ\text{C}$ unless otherwise noted)

Parameter	Symbol	Value	Unit
Peak Repetitive Reverse Voltage	$V_{RRM}$	20	V
DC Blocking Voltage	$V_R$	20	V
Average Rectified Forward Current	$I_F$	2.0	A

Stresses exceeding those listed in the Maximum Ratings table may damage the device. If any of these limits are exceeded, device functionality should not be assumed, damage may occur and reliability may be affected.

## THERMAL RESISTANCE RATINGS

Parameter	Symbol	Max	Unit
Junction-to-Ambient – Steady State (Note 3)	$R_{\theta JA}$	83	$^\circ\text{C}/\text{W}$
Junction-to-Ambient – $t \leq 5$ s (Note 3)	$R_{\theta JA}$	58	
Junction-to-Ambient – Steady State Min Pad (Note 4)	$R_{\theta JA}$	177	

3. Surface Mounted on FR4 Board using 2 in sq pad size (Cu area = 1.127 in sq [2 oz] including traces).

4. Surface Mounted on FR4 Board using the minimum recommended pad size.

## MOSFET ELECTRICAL CHARACTERISTICS ( $T_J = 25^\circ\text{C}$ unless otherwise noted)

Parameter	Symbol	Test Conditions	Min	Typ	Max	Unit
-----------	--------	-----------------	-----	-----	-----	------

### OFF CHARACTERISTICS

Drain-to-Source Breakdown Voltage	$V_{(BR)DSS}$	$V_{GS} = 0$ V, $I_D = 250$ $\mu\text{A}$	20			V
Drain-to-Source Breakdown Voltage Temperature Coefficient	$V_{(BR)DSS}/T_J$	$I_D = 250$ $\mu\text{A}$ , Ref to $25^\circ\text{C}$		10.4		$\text{mV}/^\circ\text{C}$
Zero Gate Voltage Drain Current	$I_{DSS}$	$V_{DS} = 16$ V, $V_{GS} = 0$ V			1.0	$\mu\text{A}$
					10	
Gate-to-Source Leakage Current	$I_{GSS}$	$V_{DS} = 0$ V, $V_{GS} = \pm 8.0$ V			$\pm 100$	nA

### ON CHARACTERISTICS (Note 5)

Gate Threshold Voltage	$V_{GS(TH)}$	$V_{GS} = V_{DS}$ , $I_D = 250$ $\mu\text{A}$	0.4	0.7	1.0	V
Gate Threshold Temperature Coefficient	$V_{GS(TH)}/T_J$			-3.0		$\text{mV}/^\circ\text{C}$
Drain-to-Source On-Resistance	$R_{DS(on)}$	$V_{GS} = 4.5$ V, $I_D = 3.8$ A		37	65	m $\Omega$
		$V_{GS} = 2.5$ V, $I_D = 2.0$ A		46	85	
		$V_{GS} = 1.8$ V, $I_D = 1.7$ A		65	120	
Forward Transconductance	$g_{FS}$	$V_{DS} = 10$ V, $I_D = 1.7$ A		4.2		S

### CHARGES, CAPACITANCES AND GATE RESISTANCE

Input Capacitance	$C_{ISS}$	$V_{GS} = 0$ V, $f = 1$ MHz, $V_{DS} = 10$ V		271		pF
Output Capacitance	$C_{OSS}$			72		
Reverse Transfer Capacitance	$C_{RSS}$			43		
Total Gate Charge	$Q_{G(TOT)}$	$V_{GS} = 4.5$ V, $V_{DS} = 10$ V, $I_D = 3.8$ A		3.7		nC
Threshold Gate Charge	$Q_{G(TH)}$			0.3		
Gate-to-Source Charge	$Q_{GS}$			0.6		
Gate-to-Drain Charge	$Q_{GD}$			1.0		

### SWITCHING CHARACTERISTICS (Note 6)

Turn-On Delay Time	$t_{d(ON)}$	$V_{GS} = 4.5$ V, $V_{DD} = 16$ V, $I_D = 1.0$ A, $R_G = 2.0$ $\Omega$		3.8		ns
Rise Time	$t_r$			4.7		
Turn-Off Delay Time	$t_{d(OFF)}$			11.1		
Fall Time	$t_f$			5.8		

### DRAIN-SOURCE DIODE CHARACTERISTICS

Forward Diode Voltage	$V_{SD}$	$V_{GS} = 0$ V, $I_S = 1.0$ A	$T_J = 25^\circ\text{C}$		0.69	1.0	V
Reverse Recovery Time	$t_{RR}$	$V_{GS} = 0$ V, $dI_S/dt = 100$ A/ $\mu\text{s}$ , $I_S = 1.0$ A			10.2		ns

5. Pulse Test: Pulse Width  $\leq 300$   $\mu\text{s}$ , Duty Cycle  $\leq 2\%$ .

6. Switching characteristics are independent of operating junction temperatures.

# NTLJF3118N

## SCHOTTKY DIODE ELECTRICAL CHARACTERISTICS ( $T_J = 25^\circ\text{C}$ unless otherwise noted)

Parameter	Symbol	Test Conditions	Min	Typ	Max	Unit
Maximum Instantaneous Forward Voltage	$V_F$	$I_F = 0.1\text{ A}$		0.26	0.35	V
		$I_F = 1.0\text{ A}$		0.35	0.42	
		$I_F = 2.0\text{ A}$		0.41	0.52	
Maximum Instantaneous Reverse Current	$I_R$	$V_R = 20\text{ V}$		0.20	5.0	mA
		$V_R = 10\text{ V}$		0.045	1.0	

## SCHOTTKY DIODE ELECTRICAL CHARACTERISTICS ( $T_J = 85^\circ\text{C}$ unless otherwise noted)

Parameter	Symbol	Test Conditions	Min	Typ	Max	Unit
Maximum Instantaneous Forward Voltage	$V_F$	$I_F = 0.1\text{ A}$		0.18		V
		$I_F = 1.0\text{ A}$		0.29		
		$I_F = 2.0\text{ A}$		0.36		
Maximum Instantaneous Reverse Current	$I_R$	$V_R = 20\text{ V}$		4.9		mA
		$V_R = 10\text{ V}$		1.6		

## SCHOTTKY DIODE ELECTRICAL CHARACTERISTICS ( $T_J = 125^\circ\text{C}$ unless otherwise noted)

Parameter	Symbol	Test Conditions	Min	Typ	Max	Unit
Maximum Instantaneous Forward Voltage	$V_F$	$I_F = 0.1\text{ A}$		0.13		V
		$I_F = 1.0\text{ A}$		0.25		
		$I_F = 2.0\text{ A}$		0.33		
Maximum Instantaneous Reverse Current	$I_R$	$V_R = 20\text{ V}$		42		mA
		$V_R = 10\text{ V}$		13		

## SCHOTTKY DIODE ELECTRICAL CHARACTERISTICS ( $T_J = 25^\circ\text{C}$ unless otherwise noted)

Parameter	Symbol	Test Conditions	Min	Typ	Max	Unit
Capacitance	C	$V_R = 5.0\text{ V}$ , $f = 1.0\text{ MHz}$		52.3		pF

## ORDERING INFORMATION

Device	Package	Shipping <sup>†</sup>
NTLJF3118NTAG	WDFN6 (Pb-Free)	3000 / Tape & Reel
NTLJF3118NTBG	WDFN6 (Pb-Free)	3000 / Tape & Reel

<sup>†</sup>For information on tape and reel specifications, including part orientation and tape sizes, please refer to our Tape and Reel Packaging Specifications Brochure, BRD8011/D.

# NTLJF3118N

## TYPICAL N-CHANNEL PERFORMANCE CURVES ( $T_J = 25^\circ\text{C}$ unless otherwise noted)

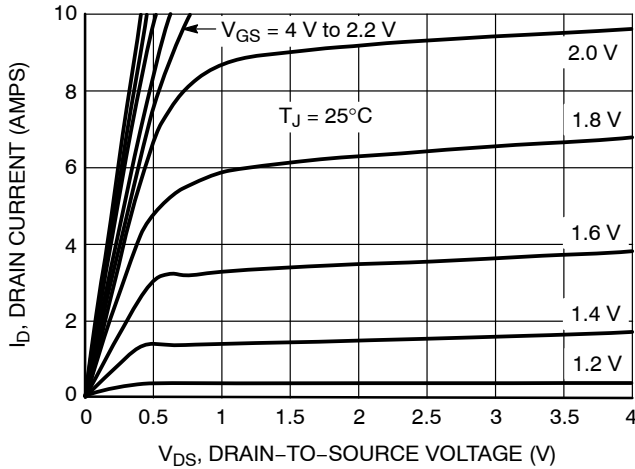

**Figure 1. On-Region Characteristics**

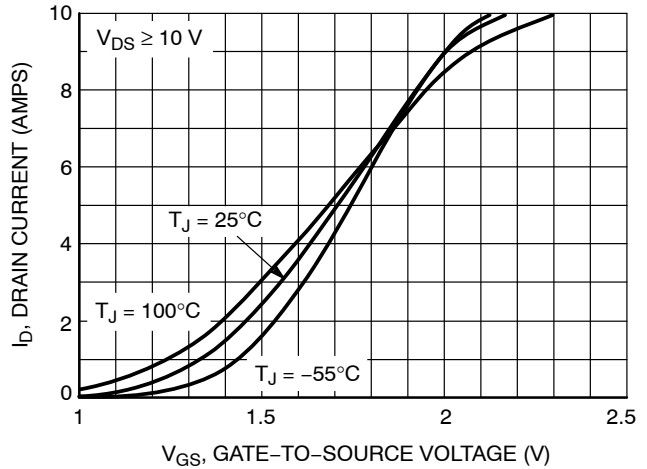

**Figure 2. Transfer Characteristics**

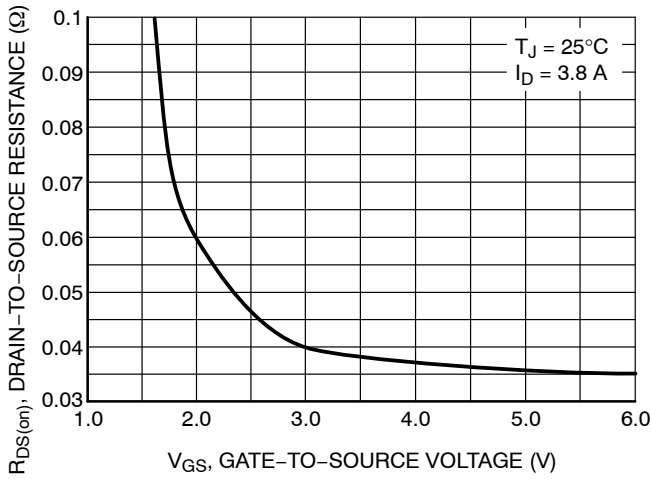

**Figure 3. On-Resistance versus Drain Current**

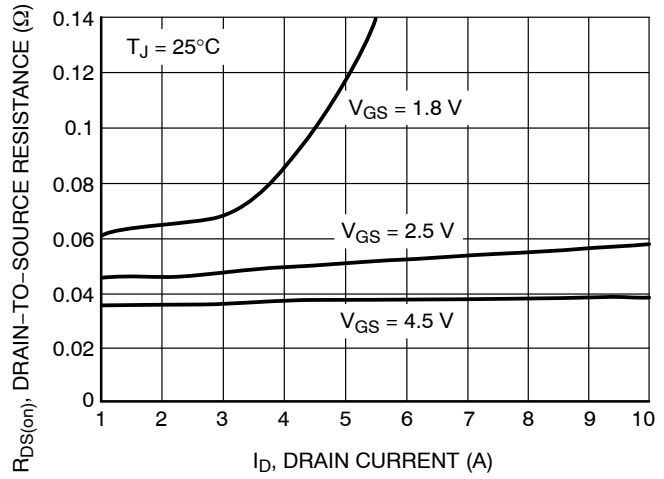

**Figure 4. On-Resistance versus Drain Current and Gate Voltage**

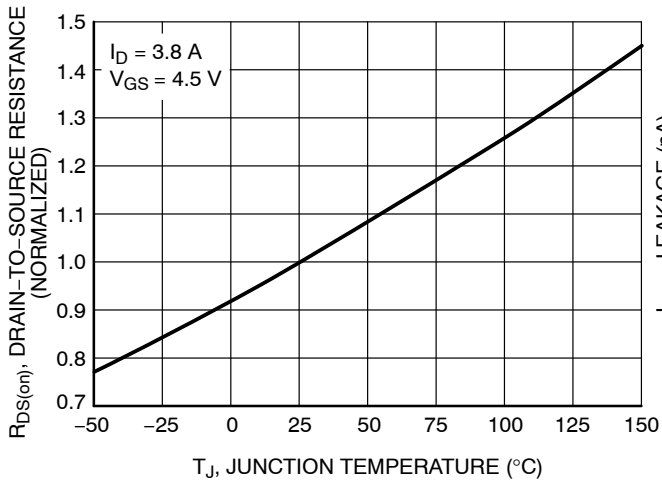

**Figure 5. On-Resistance Variation with Temperature**

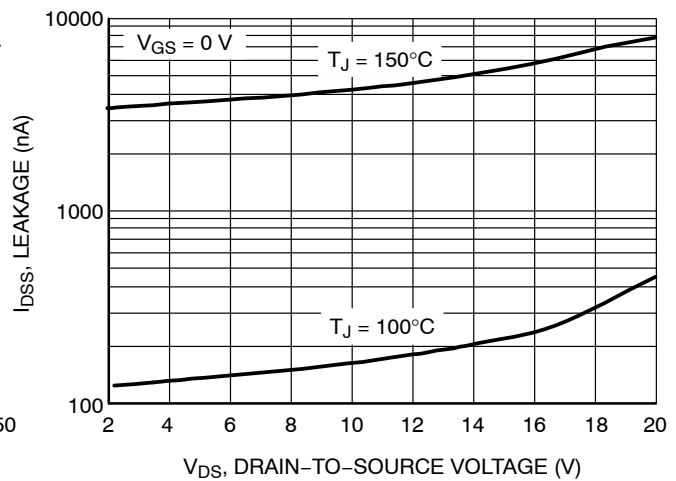

**Figure 6. Drain-to-Source Leakage Current versus Voltage**

TYPICAL N-CHANNEL PERFORMANCE CURVES ( $T_J = 25^\circ\text{C}$  unless otherwise noted)

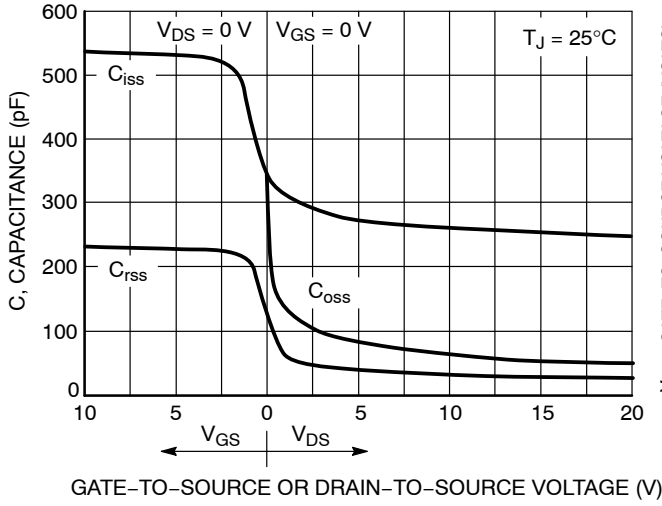

Figure 7. Capacitance Variation

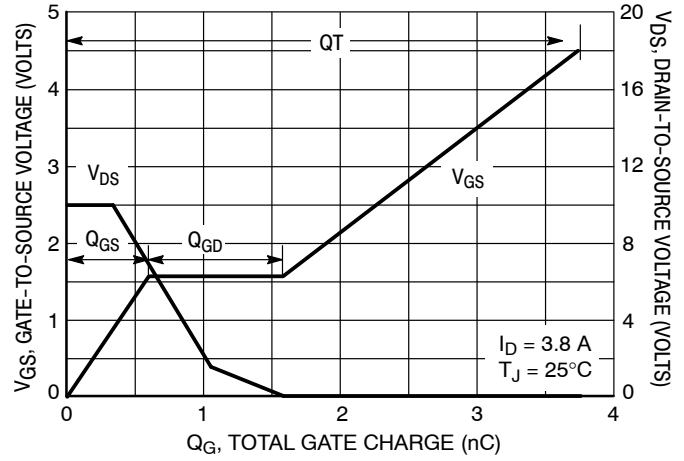

Figure 8. Gate-To-Source and Drain-To-Source Voltage versus Total Charge

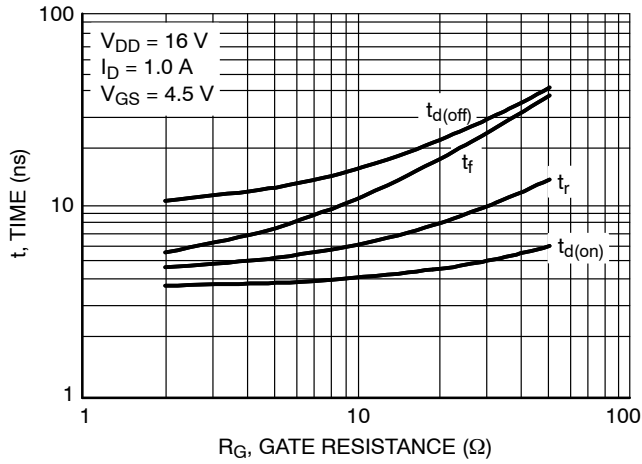

Figure 9. Resistive Switching Time Variation versus Gate Resistance

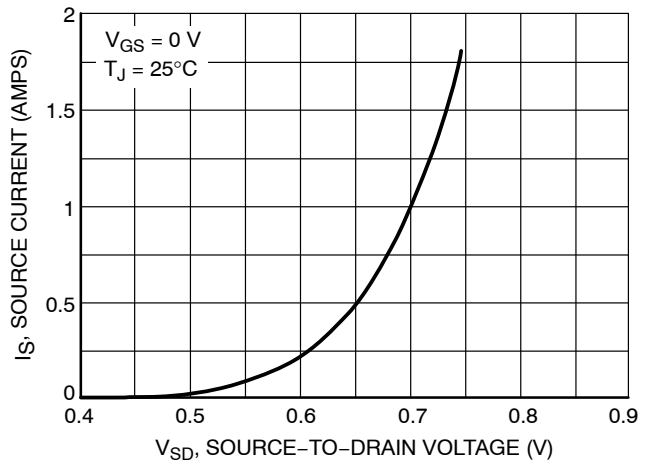

Figure 10. Diode Forward Voltage versus Current

# NTLJF3118N

## TYPICAL SCHOTTKY PERFORMANCE CURVES ( $T_J = 25^\circ\text{C}$ unless otherwise noted)

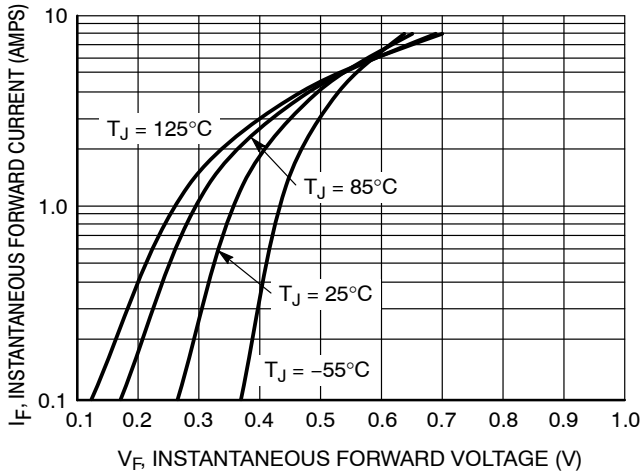

Figure 11. Typical Forward Voltage

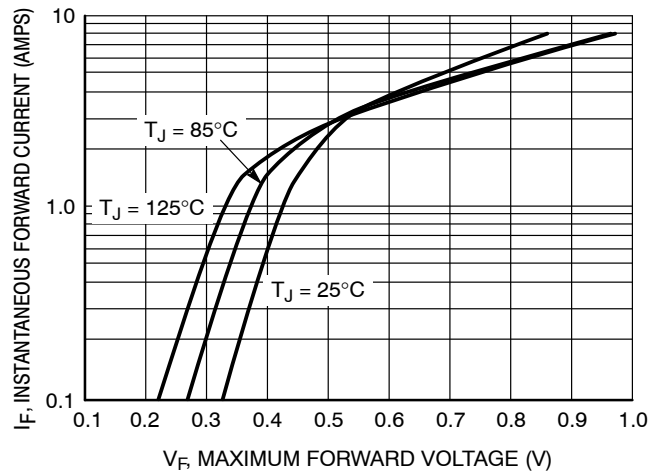

Figure 12. Maximum Forward Voltage

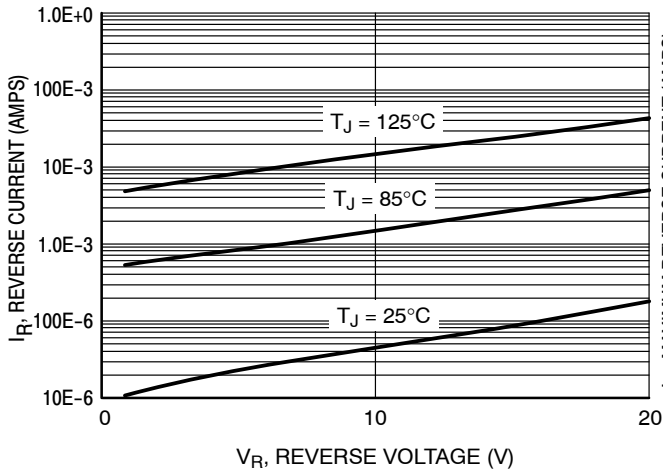

Figure 13. Typical Reverse Current

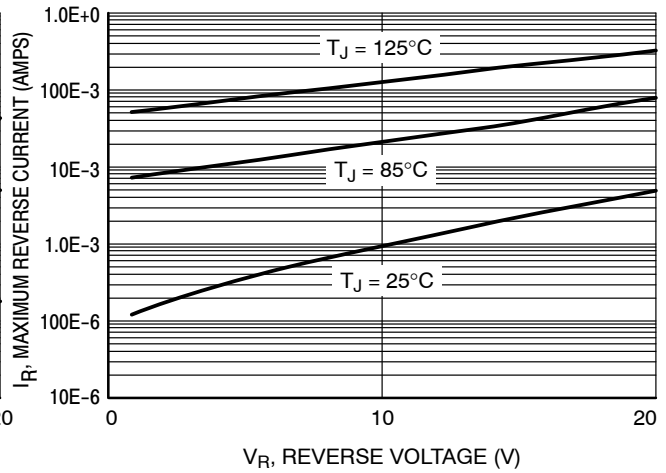
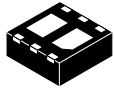

Figure 14. Maximum Reverse Current

# MECHANICAL CASE OUTLINE PACKAGE DIMENSIONS



WDFN6 2x2, 0.65P  
CASE 506AN  
ISSUE H

DATE 25 JAN 2022

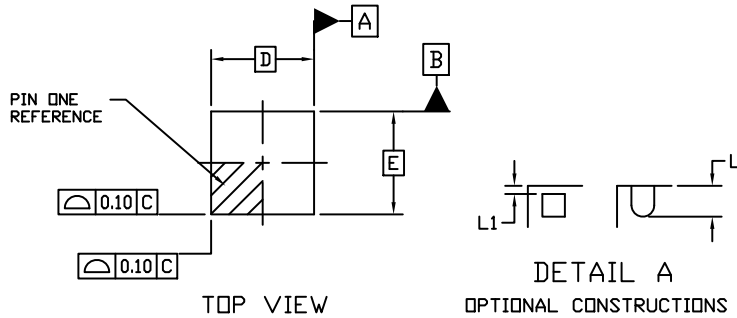

**NOTES:**

1. DIMENSIONING AND TOLERANCING PER ASME Y14.5M, 1994.
2. CONTROLLING DIMENSION: MILLIMETERS
3. DIMENSION **b** APPLIES TO PLATED TERMINAL AND IS MEASURED BETWEEN 0.15 AND 0.30 MM FROM THE TERMINAL TIP.
4. COPLANARITY APPLIES TO THE EXPOSED PADS AS WELL AS THE TERMINALS.

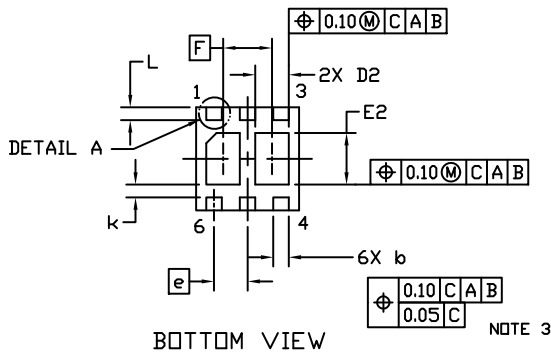
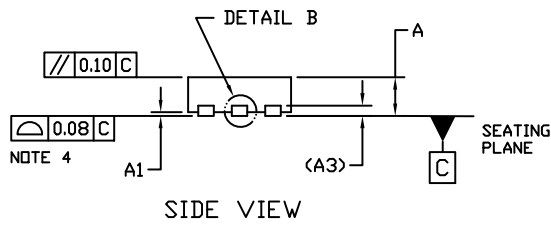

DIM	MILLIMETERS	
	MIN.	MAX.
A	0.70	0.80
A1	0.00	0.05
A3	0.20 REF	
b	0.25	0.35
D	2.00 BSC	
D2	0.57	0.77
E	2.00 BSC	
E2	0.90	1.10
e	0.65 BSC	
F	0.95 BSC	
k	0.25 REF	
L	0.20	0.30
L1	---	0.10

**GENERIC MARKING DIAGRAM\***



XX = Specific Device Code  
M = Date Code

\*This information is generic. Please refer to device data sheet for actual part marking. Pb-Free indicator, "G" or microdot "▪", may or may not be present. Some products may not follow the Generic Marking.

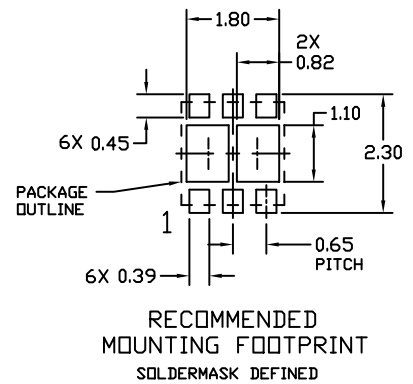

<b>DOCUMENT NUMBER:</b>	<b>98AON20861D</b>	Electronic versions are uncontrolled except when accessed directly from the Document Repository. Printed versions are uncontrolled except when stamped "CONTROLLED COPY" in red.
<b>DESCRIPTION:</b>	<b>WDFN6 2x2, 0.65P</b>	<b>PAGE 1 OF 1</b>

onsemi and ONSEMI are trademarks of Semiconductor Components Industries, LLC dba onsemi or its subsidiaries in the United States and/or other countries. onsemi reserves the right to make changes without further notice to any products herein. onsemi makes no warranty, representation or guarantee regarding the suitability of its products for any particular purpose, nor does onsemi assume any liability arising out of the application or use of any product or circuit, and specifically disclaims any and all liability, including without limitation special, consequential or incidental damages. onsemi does not convey any license under its patent rights nor the rights of others.

**onsemi**, **Onsemi**, and other names, marks, and brands are registered and/or common law trademarks of Semiconductor Components Industries, LLC dba "**onsemi**" or its affiliates and/or subsidiaries in the United States and/or other countries. **onsemi** owns the rights to a number of patents, trademarks, copyrights, trade secrets, and other intellectual property. A listing of **onsemi**'s product/patent coverage may be accessed at [www.onsemi.com/site/pdf/Patent-Marking.pdf](http://www.onsemi.com/site/pdf/Patent-Marking.pdf). **onsemi** reserves the right to make changes at any time to any products or information herein, without notice. The information herein is provided "as-is" and **onsemi** makes no warranty, representation or guarantee regarding the accuracy of the information, product features, availability, functionality, or suitability of its products for any particular purpose, nor does **onsemi** assume any liability arising out of the application or use of any product or circuit, and specifically disclaims any and all liability, including without limitation special, consequential or incidental damages. Buyer is responsible for its products and applications using **onsemi** products, including compliance with all laws, regulations and safety requirements or standards, regardless of any support or applications information provided by **onsemi**. "Typical" parameters which may be provided in **onsemi** data sheets and/or specifications can and do vary in different applications and actual performance may vary over time. All operating parameters, including "Typicals" must be validated for each customer application by customer's technical experts. **onsemi** does not convey any license under any of its intellectual property rights nor the rights of others. **onsemi** products are not designed, intended, or authorized for use as a critical component in life support systems or any FDA Class 3 medical devices or medical devices with a same or similar classification in a foreign jurisdiction or any devices intended for implantation in the human body. Should Buyer purchase or use **onsemi** products for any such unintended or unauthorized application, Buyer shall indemnify and hold **onsemi** and its officers, employees, subsidiaries, affiliates, and distributors harmless against all claims, costs, damages, and expenses, and reasonable attorney fees arising out of, directly or indirectly, any claim of personal injury or death associated with such unintended or unauthorized use, even if such claim alleges that **onsemi** was negligent regarding the design or manufacture of the part. **onsemi** is an Equal Opportunity/Affirmative Action Employer. This literature is subject to all applicable copyright laws and is not for resale in any manner.

---

## ADDITIONAL INFORMATION

### TECHNICAL PUBLICATIONS:

Technical Library: [www.onsemi.com/design/resources/technical-documentation](http://www.onsemi.com/design/resources/technical-documentation)  
onsemi Website: [www.onsemi.com](http://www.onsemi.com)

### ONLINE SUPPORT: [www.onsemi.com/support](http://www.onsemi.com/support)

For additional information, please contact your local Sales Representative at [www.onsemi.com/support/sales](http://www.onsemi.com/support/sales)