

WTH600 - WIRELESS WEATHER STATION WITH WIRELESS TRANSMITTER SENSOR

FOR USE IN NORTH AMERICA ONLY

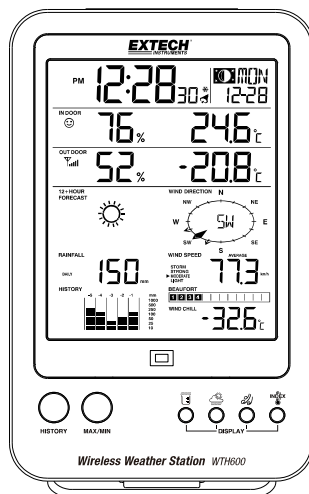
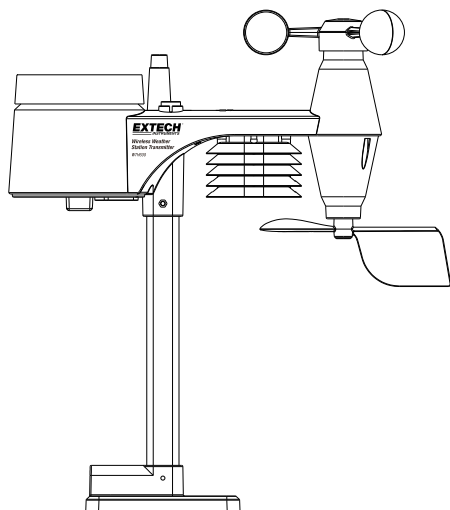

1. INTRODUCTION

Thank you for selecting the Extech WTH600 Wireless Weather Station with 5-in-1 wireless sensor. The sensor includes a self-emptying rain collector for measuring rainfall, an anemometer for wind velocity, a wind vane for wind direction, a temperature sensor, and a relative humidity sensor. The WTH600 comes fully assembled and calibrated for convenience. The sensor transmits data up to 492 ft. (150m), line of sight, to the main display unit via low power radio frequency. The main unit displays all of the weather data received from the sensor and the user can recall stored weather data (24-periods). The WTH600 is a powerful and unique personal weather station that, with proper use, will provide years of reliable service.

FEATURES

- HI/LO Alarms alert the user when programmed weather limits are exceeded
- Barometric pressure is computed and helps forecast the weather and possible storms
- Min/Max feature includes date/time stamp
- View Rainfall rate and daily/weekly/monthly amounts
- Wind-speed levels are shown expressed in Beaufort scale
- Wind-chill, Heat Index, Dew point, and Comfort level are computed and displayed

CONTENTS

1.	<i>INTRODUCTION</i>	1
2.	<i>PHYSICAL DESCRIPTIONS</i>	3
3.	<i>DISPLAY DESCRIPTIONS</i>	5
4.	<i>SENSOR INSTALLATION, BATTERIES, MOUNTING</i>	7
5.	<i>MAIN UNIT OPERATION, BATTERIES, MOUNTING</i>	9
6.	<i>WEATHER FORECAST</i>	11
7.	<i>BAROMETRIC / ATMOSPHERIC PRESSURE</i>	11
8.	<i>RAINFALL</i>	12
9.	<i>WIND SPEED / DIRECTION</i>	12
10.	<i>BEAUFORT SCALE</i>	13
11.	<i>WIND CHILL / HEAT INDEX / DEW POINT</i>	14
12.	<i>HISTORICAL DATA (PRIOR 24 HOURS)</i>	15
13.	<i>MAXIMUM / MINIMUM MEMORY</i>	15
14.	<i>HI / LO WEATHER ALERT</i>	15
15.	<i>WIRELESS SIGNAL RECEPTION</i>	16
16.	<i>TEMPERATURE/HUMIDITY COMFORT LEVELS</i>	16
17.	<i>CLEARING STRAY READINGS</i>	17
18.	<i>POINTING SENSOR TO THE SOUTH</i>	17
19.	<i>MOON PHASES</i>	17
20.	<i>CLEANING</i>	18
21.	<i>TROUBLESHOOTING</i>	18
22.	<i>PRECAUTIONS</i>	19
23.	<i>FCC STATEMENT</i>	19
24.	<i>SPECIFICATIONS</i>	20
25.	<i>Warranty</i>	22

2. PHYSICAL DESCRIPTIONS

Main unit

1. SNOOZE / LIGHT button
2. HISTORY button
3. MAX/MIN button
4. RAINFALL button
5. BARO button
6. WIND button
7. INDEX button
8. CLOCK button
9. ALARM button
10. ALERT button
11. DOWN button
12. UP button
13. °C/°F slide switch
14. RCC button
15. SCAN button
16. RESET button
17. Battery compartment
18. Alert LED indicator
19. LCD display with backlight
20. Table stand

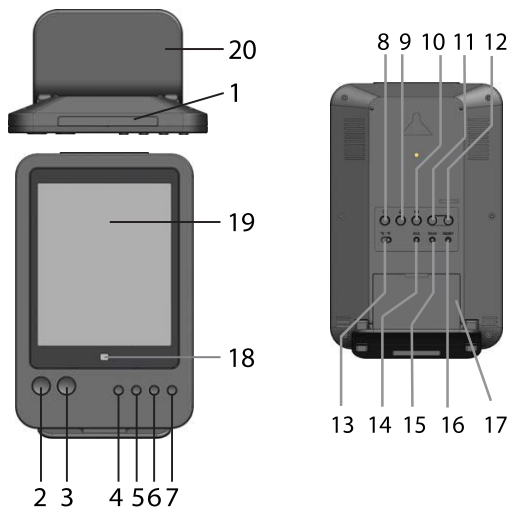

Wireless Sensor

1. Rain collector
2. Balance indicator
3. Antenna
4. Wind cups
5. Mounting pole
6. Radiation shield
7. Wind vane
8. Mounting base
9. Mounting clamp
10. Red LED indicator
11. RESET button
12. Battery door
13. Screws

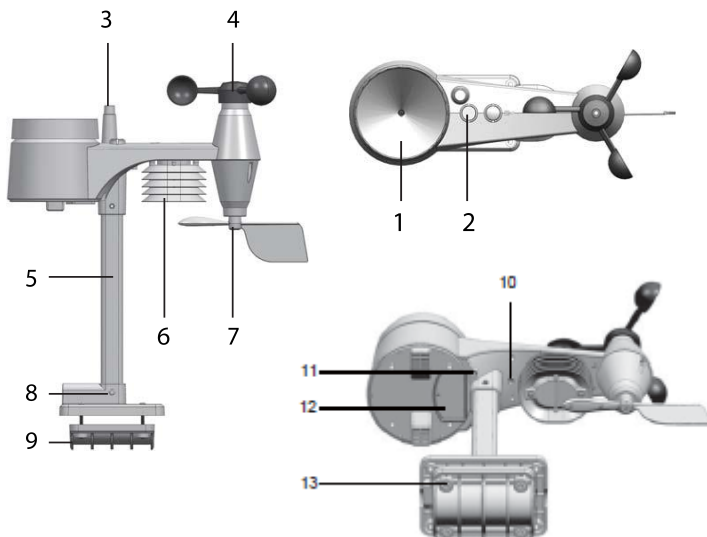

Rain gauge

1. Rain collector
2. Tipping bucket
3. Rain sensor
4. Drain holes

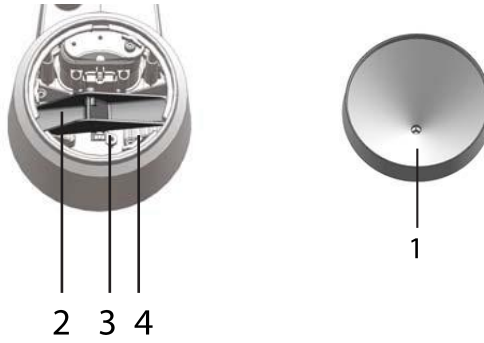

Temperature and humidity sensor

1. Radiation shield
2. Sensor casing

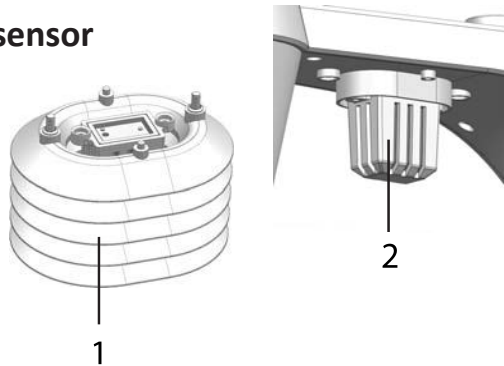

Wind sensor

1. Wind cups (anemometer)
2. Wind vane (direction)

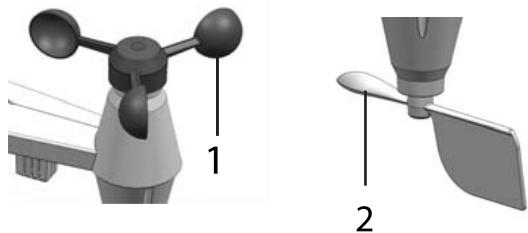

3. DISPLAY DESCRIPTIONS

Main Display

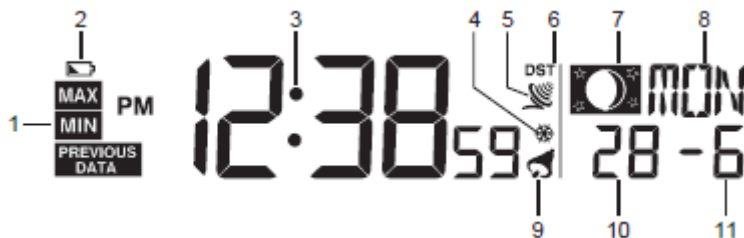

1. Max/Min/Previous indicator
2. Low battery indicator for main unit
3. Time
4. Ice pre-alert on
5. RC Signal strength indicator
6. DST icon
7. Moon phase
8. Day of the week
9. Alarm icon
10. Date
11. Month

Indoor Temperature/Humidity Display

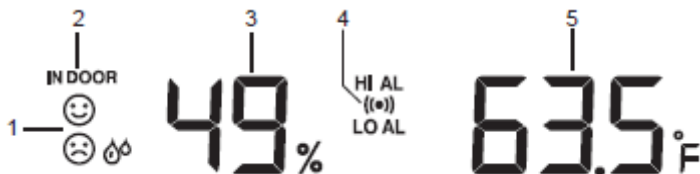

1. Comfort/cold/hot icon
2. Indoor indicator
3. Indoor humidity
4. Hi / Lo Alert and Alarm
5. Indoor temperature

Outdoor Temperature/Humidity Display

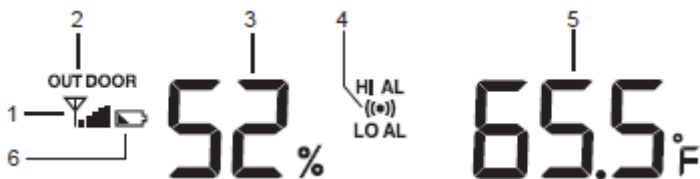

1. Outdoor signal strength indicator
2. Outdoor indicator
3. Outdoor humidity
4. Hi / Lo Alert and Alarm
5. Outdoor temperature
6. Low battery indicator for sensor

12+ Hour Forecast Display

1. Weather forecast indicator
2. Weather forecast icon



Barometer Display

1. Barometer indicator
2. Histogram
3. Absolute/Relative indicator
4. Barometer units (hPa / inHg / mmHg)
5. Barometer reading
6. Hourly records indicator

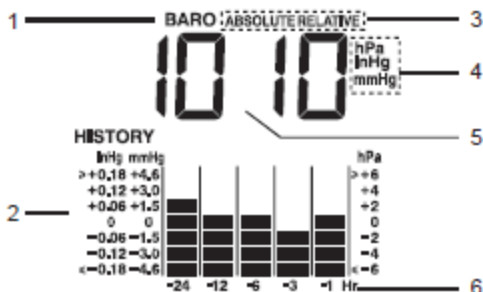

Rainfall Display

1. Rainfall indicator
2. Time range record indicator
3. Day records indicator
4. Histogram
5. Hi Alert and Alarm
6. Current rainfall rate
7. Rainfall unit (in / mm)

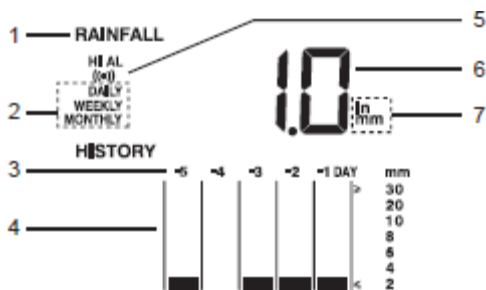

Wind Direction/Wind speed

1. Wind direction indicator
2. Wind direction indicator(s) during last hour
3. Current wind direction indicator
4. Wind speed indicator
5. Wind levels and indicator
6. Beaufort scale reading
7. Current wind direction reading
8. Average/Gust wind indicator
9. Wind speed units (mph, m/s, km/h, knots)
10. Hi Alert and Alarm

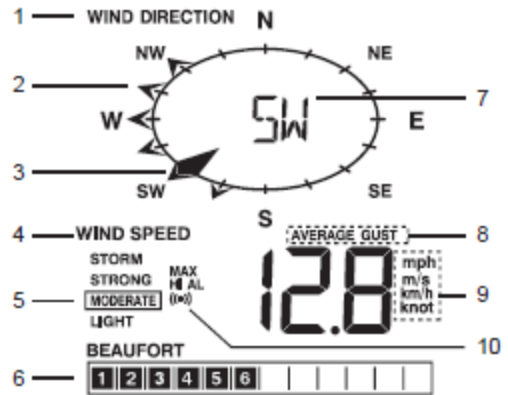

Wind Chill/ Heat index/ Indoor Dew point

1. Wind chill/ Heat index/ Indoor dew point indicator
2. Wind chill/ Heat index/ Indoor dew point reading



4. SENSOR INSTALLATION, BATTERIES, MOUNTING

Wireless Sensor

The wireless sensor measures wind-speed, wind-direction, rainfall, temperature and humidity. The sensor ships fully assembled and calibrated for easy installation.

Battery and installation

Unscrew the battery door at bottom of unit and insert the batteries according to the “+/-”polarity indicated. Screw the battery door compartment on tightly. Note:

1. Align the watertight O-ring to ensure water-resistance.
2. The red LED will begin flashing every 12 seconds.

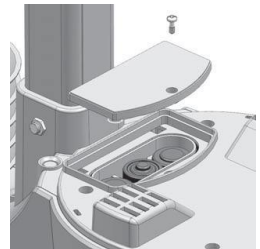

Install the wireless sensor in an open location with no obstructions above and around the sensor for accurate rain and wind measurement. Install the sensor with the smaller end facing to the North (proper orientation of the wind direction vane). Secure the mounting stand and bracket (included) to a post or pole, and allow a minimum distance of 1.5m off the ground.

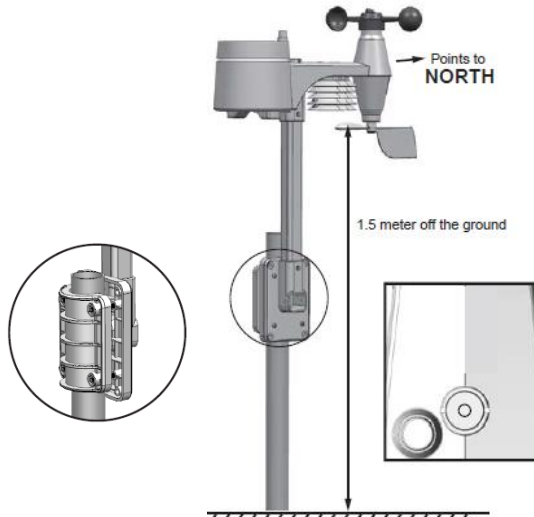

Mounting guidelines

1. Install the wireless sensor at least 1.5m off the ground for accurate wind measurements.
2. Choose an open area within 150 meters from the Main Unit.
3. Install the wireless sensor as level as possible to achieve accurate rain and wind measurements. The included leveling device ensures a level installation.
4. Mount the wireless sensor with the wind meter end pointing to the North.
5. Pole mount shown below left and railing mount below right.



5. MAIN UNIT OPERATION, BATTERIES, MOUNTING

Battery Installation and Mounting



The WTH600 can be placed on a desktop or can be wall mounted for easy viewing.

1. Remove the battery door of the main unit.
2. Insert three 'AA' batteries according to the "+/-" polarity marks on the battery compartment.
3. Replace the battery door.
4. Once the batteries are inserted all of the LCD segments will be shown briefly before entering the radio-controlled time reception mode.
5. The RC clock will automatically start scanning for the radio-controlled time signal in 8 seconds.

Note:

1. If no display appears, press the RESET button using a paper clip or other pointed object.
2. In some cases, you may not receive the signal immediately due to atmospheric disturbance.

Pairing the Sensor with the Main Unit

After insertion of batteries, the Main Unit will automatically search for and connect with the wireless sensor (antenna icon blinking). When successful, the antenna icon and readings for outdoor temperature, humidity, wind speed, wind direction, and rainfall will appear on the display.

Manual Pairing after Replacing Batteries

Each time that you replace the sensor's batteries, you must perform a manual pairing.

1. Replace the batteries.
2. Press the [SCAN] button.
3. Press the [RESET] button on the sensor (bottom of sensor).

Note:

1. Pressing [RESET] generates a new code for pairing purposes.
2. Please dispose of batteries in an environmentally safe manner and in accordance with all relevant law and regulations.

Radio-controlled (RC) Time Signal

When the unit receives the RC signal, a sync-time symbol  will appear on the LCD. Note that the unit synchronizes daily.

Note:

1. The strength of the signal from the transmitter tower may be affected by geographical location or surrounding buildings.

2. Always place the unit away from interfering sources such as TV monitors, computers, etc.
3. Avoid placing the unit on or next to metal plates.
4. Enclosed areas such as airports, basements, or factories are not recommended.

Setting the Date and Time

The unit automatically sets itself accordingly to the Radio Controlled Clock signal it receives. To set the clock/calendar manually, first disable the reception by holding the RCC button for 8 seconds.

Manually Setting the Clock and Time Zone

1. Press and hold [CLOCK] button for 2 seconds until "12 or 24Hr" flashes.
2. Use [UP]/[DOWN] buttons to adjust, and press [CLOCK] button to continue.
3. Repeat step 2 above for **TIME ZONE, HOUR, MINUTE, SECOND, YEAR, MONTH, DATE, and HOUR OFFSET.**

Language and DST (Daylight Savings Time) settings

Note:

1. If no buttons are pressed within 60 seconds, the unit will automatically exit this setting mode.
2. The time zone setting applies only to the North American version where the unit is set to receive the WWVB signal. User can select PST, MST, CST, EST, AST or NST.
3. The language options are English (EN), French (FR), German (DE), Spanish (ES), and Italian (IT).
4. DST (Daylight Saving Time) feature defaults to Auto. The clock is programmed to automatically switch when the daylight saving time is in effect. User can set the DST to OFF to disable the feature.

Disable / Enable RCC Signal Reception



1. Press and hold [RCC] button for 8 seconds to disable the reception.
2. Press and hold [RCC] button for 8 seconds to enable automatic RCC reception.

Turn Alarm Clock On/Off (with ice-alert function)

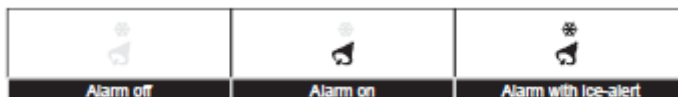

1. Press the [ALARM] button anytime to show the alarm time.
2. Press [ALARM] button to activate the alarm.
3. Press again to activate alarm with ice-alert function.
4. To disable the alarm, press until the alarm icon disappears.

Set the Alarm Clock

1. Press and hold [ALARM] for 2 seconds to enter alarm setting mode. HOUR will begin to flash.
2. Use [UP]/[DOWN] buttons to adjust HOUR, and press [ALARM] button to proceed to MINUTE.
3. Repeat step 2 above to set MINUTE, then press [ALARM] button to exit.

Note: Pressing the [ALARM] button twice when alarm time is displayed will activate the temperature-adjusted pre-alarm (alarm will sound 30 minutes earlier if it detects outside temperature is below 26°F (-3°C)).

6. WEATHER FORECAST

The WTH600 includes a sensitive pressure sensor that predicts weather for the next 12 ~ 24 hours within a 19-31 miles (30 to 50km) radius.

Note:

1. The accuracy of a general pressure-based weather forecast is about 70% to 75%.
2. The weather forecast does not necessarily reflect the current weather conditions.
3. The “Snowy” weather forecast is not based on atmospheric pressure; it is based on outdoor temperature. When the outdoor temperature is below 26°F (-3°C), the “Snowy” weather indicator will be displayed on the LCD.

7. BAROMETRIC / ATMOSPHERIC PRESSURE

Atmospheric Pressure is the pressure at any location of the Earth caused by the weight of the column of air above it. One atmospheric pressure refers to the average pressure and gradually decreases as altitude increases. Meteorologists use barometers to measure atmospheric pressure. Since variation in atmospheric pressure is greatly affected by weather, it is possible to forecast the weather by measuring the changes in pressure.

Select the Display mode

Press and hold the [BARO] button for 2 seconds to toggle between:

- **ABSOLUTE** the absolute atmospheric pressure of your location
- **RELATIVE** the relative atmospheric pressure based on sea level

Set the Relative Atmospheric Pressure

1. Obtain the atmospheric pressure data for the sea level (the relative atmospheric pressure for your current location) through the local weather service, internet or other channel.
2. Press and hold [BARO] for 2 seconds until “ABSOLUTE” or “RELATIVE” icon flashes.
3. Press [UP]/[DOWN] button to switch to “RELATIVE” mode.
4. Press [BARO] button again until the “RELATIVE” atmospheric pressure digit flashes.
5. Press [UP]/[DOWN] button to change its value.
6. Press [BARO] button to save and exit the setting mode.

Note:

1. The default relative atmospheric pressure value is 29.91 inHg (1013 hPa), which refers to the average atmospheric pressure.
2. When you change the relative atmospheric pressure value, the weather indicators will change.

- The built-in barometer detects the environmental absolute atmospheric pressure changes. Based on the data collected, it can predict weather conditions for the next 12 hours. The weather indicators will change according to the detected absolute atmospheric pressure after 1 hour.
- The relative atmospheric pressure is based on the sea level, but it will change with the absolute atmospheric pressure changes after operating the clock for 1 hour.

Select the Measurement Units for the Barometer

- Press the [BARO] button to enter the unit setting mode.
- Use the [BARO] button to change the units to **inHg** (inches of mercury) / **mmHg** (millimeter of mercury) (millibars per hectopascal) / **hPa**.
- Press the [BARO] button to confirm.

8. RAINFALL

Select Rainfall Display mode:

The device displays how many mm / inches of rain are accumulated in a one hour time period, based on current rainfall rate. Press [RAINFALL] button to select from the following:

- **RATE** Current rainfall rate in the past hour
 - **DAILY** The DAILY display indicates the total rainfall from midnight
 - **WEEKLY** The WEEKLY display indicates the total rainfall from the current week
 - **MONTHLY** The MONTHLY display indicates the total rainfall from the current calendar month
- Note: Rain rate is updated every 6 minutes, at every hour on the hour, and at 6, 12, 18, 24, 30, 36, 42, 48, 54 minutes past the hour.



Select the measurement unit for rainfall:

- Press and hold [RAINFALL] button 2 seconds to enter unit setting mode.
- Use [UP] / [DOWN] button to toggle between **mm** (millimeter) and **in** (inch).
- Press [RAINFALL] button to confirm and exit.

9. WIND SPEED / DIRECTION

Read the Wind Direction

Wind Direction Indicator	Meaning
	Real-time wind direction
	Wind directions appeared in last 5 minutes (max 6)



Select the Wind Display mode

Press [WIND] button to toggle between:

- **AVERAGE** The AVERAGE wind speed will display the average of all wind speed numbers recorded in the previous 30 seconds
- **GUST** The GUST wind speed will display the highest wind speed recorded from last reading



The wind level provides a quick reference and is indicated by a series of text icons:

Level	LIGHT	MODERATE	STRONG	STORM
Speed	2-8 mph 3-13 km/h	9-25 mph 14-41 km/h	26-54 mph 42-87 km/h	≥ 55 mph ≥ 88 km/h

Select Wind Speed Units

1. Press and hold [WIND] button for 2 seconds to enter unit setting mode.
2. Use the [UP] / [DOWN] button to change the unit between **mph** (miles per hour) / **m/s** (meter per second) / **km/h** (kilometer per hour) / **knots**.
3. Press [WIND] button to confirm and exit.

10. BEAUFORT SCALE

Beaufort scale is an international scale of wind velocities from 0 (calm) to 12 (Hurricane force).

Beaufort no.	Description	Wind speed	Land conditions
0	Calm	< 1 km/h	Calm. Smoke rises vertically.
		< 1 mph	
		< 1 knot	
		< 0.3 m/s	
1	Light air	1.1–5.5 km/h	Smoke drift indicates wind direction. Leaves and wind vanes are stationary.
		1–3 mph	
		1–3 knots	
		0.3–1.5 m/s	
2	Light breeze	5.6–11 km/h	Wind felt on exposed skin. Leaves rustle. Wind vanes begin to move.
		4–7 mph	
		4–6 knots	
		1.6–3.4 m/s	
3	Gentle breeze	12–19 km/h	Leaves and small twigs constantly moving, light flags extended.
		8–12 mph	
		7–10 knots	
		3.5–5.4 m/s	
4	Moderate breeze	20–28 km/h	Dust and loose paper raised. Small branches begin to move.
		13–17 mph	
		11–16 knots	
		5.5–7.9 m/s	
5	Fresh breeze	29–38 km/h	Branches of a moderate size move. Small trees in leaf begin to sway.
		18–24 mph	
		17–21 knots	
		8.0–10.7 m/s	

6	Strong breeze	39–49 km/h	Large branches in motion. Whistling heard in overhead wires. Umbrella use becomes difficult. Empty plastic bins tip over.
		25–30 mph	
		22–27 knots	
		10.8–13.8 m/s	
7	High wind	50–61 km/h	Whole trees in motion. Effort needed to walk against the wind.
		31–38 mph	
		28–33 knots	
		13.9–17.1 m/s	
8	Gale	62–74 km/h	Some twigs broken from trees. Cars veer on road. Progress on foot is seriously impeded.
		39–46 mph	
		34–40 knots	
		17.2–20.7 m/s	
9	Strong gale	75–88 km/h	Some branches break off trees, and some small trees blow over. Construction/temporary signs and barricades blow over.
		47–54 mph	
		41–47 knots	
		20.8–24.4 m/s	
10	Storm	89–102 km/h	Trees are split or uprooted, structural damage likely.
		55–63 mph	
		48–55 knots	
		24.5–28.4 m/s	
11	Violent storm	103–117 km/h	Widespread vegetation and structural damage likely.
		64–73 mph	
		56–63 knots	
		28.5–32.6 m/s	
12	Hurricane force	≥ 118 km/h	Severe widespread damage to vegetation and structures. Debris and unsecured objects become airborne.
		≥ 74 mph	
		≥ 64 knots	
		≥ 32.7m/s	

11. WIND CHILL / HEAT INDEX / DEW POINT

View the Wind Chill

Press the [INDEX] button repeatedly until the WINDCHILL appears.

Note: The wind chill factor is based on the combined effects of temperature and wind speed. The wind chill displayed is calculated solely from temperature and humidity measured by the wireless sensor.

View the Heat Index

Press the [INDEX] button repeatedly until the HEAT INDEX appears.

Note: Heat index is only calculated when temperature is 80°F/27°C or above, and based solely from the temperature and humidity measured by the wireless sensor.

Heat Index Range	Warning	Explanation
80°F to 90°F (27°C to 32°C)	Caution	Possibility of heat exhaustion
91°F to 105°F (33°C to 40°C)	Extreme Caution	Possibility of heat dehydration
106°F to 129°F (41°C to 54°C)	Danger	Heat exhaustion likely
≥130°F (≥55°C)	Extreme Danger	Strong risk of dehydration / sun stroke

View Dew point (Indoor)

Press the [INDEX] button repeatedly until DEWPOINT appears.

Note: The dew point is the temperature below which the water vapor in air, at a constant barometric pressure, condenses into liquid water at the same rate at which it evaporates. 'Dew' is the term used to describe the condensed water that forms on a solid surface. The dew point temperature is calculated from the indoor temperature/humidity measured at the Main Unit.

12. HISTORICAL DATA (PRIOR 24 HOURS)

The main unit automatically records and displays data from the previous 24 hours on the hour. To check all of the historical data from the past 24 hours, press the [HISTORY] button. E.g. Current time 7:25 am, March 28

Press [HISTORY] repeatedly to view prior readings at 7:00am, 6:00am, 5:00am, ..., 5:00am (Mar 27), 6:00am (Mar 27), 7:00am (Mar 27)

The LCD will display the prior indoor and outdoor temperature & humidity, air pressure, wind chill, wind speed, rainfall along with the time and date.

13. MAXIMUM / MINIMUM MEMORY

Press the [MAX/MIN] button to view the maximum/minimum records in the following sequence:

- Outdoor MAX temperature, Outdoor MIN temperature
- Outdoor MAX humidity, Outdoor MIN humidity
- Indoor MAX temperature, Indoor MIN temperature
- Indoor MAX humidity, Indoor MIN humidity
- Outdoor MAX wind chill, Outdoor MIN wind chill
- Outdoor MAX heat index, Outdoor MIN heat index
- Indoor MAX dew point, Indoor MIN dew point
- MAX pressure, MIN pressure
- MAX average gust
- MAX gust
- Max rainfall

Press and hold [MAX/MIN] for 2 seconds to reset the MAX/MIN records. Note: The display shows date/time stamp along with all maximum or minimum readings.

14. HI / LO WEATHER ALERT

The WTH60 can alert you to specific weather conditions. When the alert function is active, the amber LED flashes when certain conditions exist; see table below.

Area	Types of Alerts Available
Indoor Temperature	HI and LO alert
Indoor Humidity	HI and LO alert
Outdoor Temperature	HI and LO alert
Outdoor Humidity	HI and LO alert
Rainfall	HI alert (rainfall since midnight)
Wind speed	HI alert

Set the HI / LO alert

1. Press the [ALERT] button to select the desired display field.
2. Use [UP] / [DOWN] buttons to adjust the settings.
3. Press [ALERT] button to confirm and continue to the next setting.

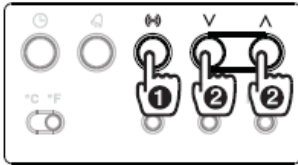

Enable/disable the HI / LO Alarm Alert

1. Press the [ALERT] button to select the desired display field.
2. Use [ALARM] to turn the alert on or off.
3. Press [ALERT] to continue to the next setting.

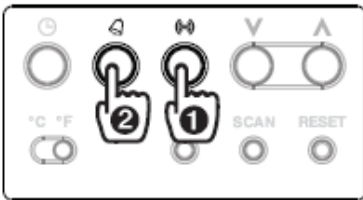

Note:

1. The unit will automatically exit setting mode in 5 seconds if no button is pressed.
2. When ALERT alarm is on, the area and type of alert that triggered the alarm will be flashing and the alarm will sound for 2 minutes.
3. To silence the Alert alarm beeper, press the [SNOOZE / LIGHT] / [ALARM] button, or allow the beeper to automatically turn off after 2 minutes.

15. WIRELESS SIGNAL RECEPTION



The sensor transmits data wirelessly over an approximate range of 150m (line of sight). Occasionally, due to intermittent physical obstructions or other environmental interference, the signal may weaken or be lost. If the sensor signal is lost completely, please relocate the main unit or the wireless sensor.

16. TEMPERATURE/HUMIDITY COMFORT LEVELS

Comfort Indication

The comfort pictorial indication is based on indoor air temperature and humidity.

		
Too cold	Comfortable	Too hot

Note:

1. Comfort indication can vary at the same temperature, depending on the humidity.
2. There is no comfort indication when temperature is below 32°F (0°C) or above 140°F (60°C).

17. CLEARING STRAY READINGS

During installation of the wireless sensor, the sensors are typically triggered which results in erroneous rainfall and wind measurements. After the installation, the user may clear all of the erroneous data from the Main Unit, without having to reset the clock and re-establish pairing. Simply press and hold the [HISTORY] button for 10 seconds. This will clear all data.

18. POINTING SENSOR TO THE SOUTH

The outdoor sensor is calibrated to be pointing to North by default. However, in some cases, users may wish to install the product with the arrow pointing towards the South, especially for those living in the Southern hemisphere (e.g. Australia, New Zealand).

1. Install the outdoor sensor with its arrow pointing to the South.
2. On the main unit, press and hold [WIND] for 8 seconds until the upper part (Northern Hemisphere) of the compass lights and starts blinking.
3. Use [UP] / [DOWN] to move to the lower part (Southern Hemisphere).

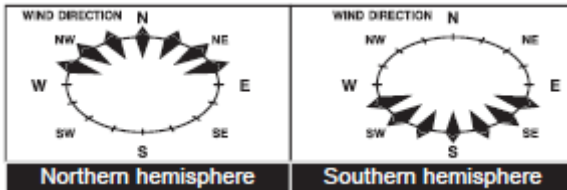









4. Press the [WIND] button to confirm and exit.

Note: Changing hemispheres will automatically switch the direction of the displayed moon phases.









19. MOON PHASES

In the Northern hemisphere, the moon waxes (the part of the moon we see that glows after the New Moon) from the right. Hence, the sun-lit area of the moon moves from right to left in the Northern Hemisphere, while in the Southern Hemisphere, it moves from left to right. Below are two tables illustrating how the moon phase will appear on the main unit.

Northern hemisphere:

	New Moon		Full Moon
	Waxing Crescent		Waning Gibbous
	First quarter		Third quarter
	Waxing Gibbous		Waning Crescent

Southern hemisphere:

	New Moon		Full Moon
	Waxing crescent		Waning Gibbous
	First quarter		Third quarter
	Waxing Gibbous		Waning Crescent

20. CLEANING

Cleaning the Rain Collector

1. Rotate the rain collector 30° counter-clockwise.
2. Gently remove the rain collector.
3. Clean and remove debris.
4. Allow components to dry before re-assembly.

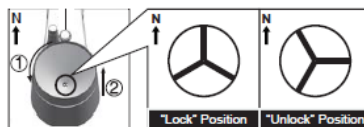



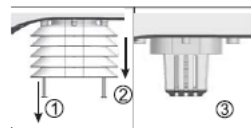

Cleaning the Thermo-Hygro sensor

1. Unscrew the 2 screws at the bottom of the radiation shield.
2. Gently pull out the shield.
3. Remove carefully any dirt or insects inside the sensor casing (Do not let the sensors inside get wet).
4. Clean the shield with water and remove any dirt.
5. Re-assemble after fully cleaning and drying.



21. TROUBLESHOOTING

Problem/Symptom	Solution
Unusual or no rain sensor measurement	Check the drain hole on rain collector Check balance indicator
Unusual or no thermos/Hygro sensor measurement	Check radiation shield Check sensor casing
Unusual or no wind speed/direction measurement	Check wind cups (anemometer) Check wind vane
Signal lost for 15 minutes  and 	Relocate main unit and sensor close to each other. Ensure the main unit is placed away from other electrical appliances that may interfere with wireless communication
Signal lost for 1 hour  and 	Reset both main unit and sensor

22. PRECAUTIONS

- Please observe all warnings and follow all instructions.
- Do not subject the unit to excessive force, shock, dust, temperature or humidity.
- Do not obstruct the ventilation holes.
- Do not immerse in water. If the unit gets wet, dry it immediately with a soft, lint-free cloth.
- Do not clean the unit with abrasive or corrosive materials.
- Do not tamper with the unit's internal components. This invalidates the warranty.
- Use new batteries only. Do not mix new and old batteries.
- Dispose of this product responsibly.
- Placement of this product on certain types of wood may result in damage to its finish.
- Do not attempt to service this device; doing so may result in fire or electric shock.
- Dispose of batteries responsibly and in compliance with all regulatory restrictions.
- Please note that some units are equipped with a battery safety strip. Remove the strip from the battery compartment before first use.

23. FCC STATEMENT

This device complies with Part 15 of the FCC Rules. Operation is subject to the following two conditions: (1) this device may not cause harmful interference, and (2) this device must accept any interference received, including interference that may cause undesired operation.

Warning: Changes or modifications to this unit not expressly approved by the party responsible for compliance could void the user's authority to operate the equipment.

NOTE: This equipment has been tested and found to comply with the limits for a Class B digital device, pursuant to Part 15 of the FCC Rules. These limits are designed to provide reasonable protection against harmful interference in a residential installation. This equipment generates uses and can radiate radio frequency energy and, if not installed and used in accordance with the instructions, may cause harmful interference to radio communications.

However, there is no guarantee that interference will not occur in a particular installation. If this equipment does cause harmful interference to radio or television reception, which can be determined by turning the equipment off and on, the user is encouraged to try to correct the interference by one or more of the following measures:

- Reorient or relocate the receiving antenna.
- Increase the separation between the equipment and receiver.
- Connect the equipment into an outlet on a circuit different from that to which the receiver is connected.
- Consult the dealer or an experienced radio/TV technician for help.

This device complies with Industry Canada License-exempt RSS-210. Operation is subject to the following two conditions: (1) this device may not cause interference, and (2) this device must accept any interference, including interference that may cause undesired operation of the device.

FCC Responsible party:

Company Name: FLIR Commercial Systems, Inc.
Address: 9 Townsend West, Nashua NH 03063 USA
Phone: 1- 603-324-7842

IC: 1590A-WTH600
CAN RSS-Gen/CNR-Gen.
FCC ID: IWK-WTH600

24. SPECIFICATIONS

MAIN UNIT	
Dimensions (W x H x D)	4.7 x 7.5 x 0.9" (120 x 190 x 22 mm)
Weight	13.1 oz. (370g) with batteries
Battery power	3 x AA size 1.5V batteries (Alkaline recommended)
Sensor displays	Wind speed, Wind direction, Rain gauge, Temp., RH
INDOOR BAROMETER	
Barometer units	hPa, inHg and mmHg
Measuring Range	540~1100 hPa; 405~825 mmHg; 15.95~32.48 inHg
Resolution	1hPa, 0.01inHg, 0.1mmHg
Accuracy@ 32~122°F (0~50°C)	540~699hPa ±8 hPa / 700~1100hPa ±4 hPa 405~524 mmHg ±6 mmHg / 525~825 mmHg ±3 mmHg 15.95~20.66 inHg 0.24 inHg / 20.67~32.48 inHg ±0.12 inHg
Weather forecast	Sunny / Clear, slightly Cloudy, Cloudy, Rainy, Rainy / Stormy and Snowy
Display modes	Current, Max, Min, Historical data for last 24hrs
Memory modes	Max & Min from last memory reset (with time stamp)
INDOOR TEMPERATURE	
Temp. units	°F or °C
Display range	-40°F to 158°F (-40°C to 70°C)
Operating range	14°F to 122°F (-10°C to 50°C)
Resolution	0.1°F or 0.1°C
Accuracy	+/- 2°F or 1°C typical @ 77°F (25°C)
Display modes	Current, Min and Max, Historical data for past 24 hours
Memory modes	Max & Min from last memory reset (with time stamp)
Alarm	Hi / Lo Temperature Alert
INDOOR HUMIDITY	
Display range	20% to 90% RH (< 20%: LO; > 90%: HI); Temp.: 0°C~60°C (32°F~140°F)
Operating range	20% to 90%RH
Resolution	1%
Accuracy	+/-5% typical @ 77°F (25°C)
Display modes	Current, Min and Max, Historical data for past 24 hours
Memory modes	Max & Min from last memory reset (with time stamp)
Alarm	Hi / Lo Humidity Alert
RADIO CONTROLLED ATOMIC CLOCK	
Synchronization	Auto or disabled
Clock display	HH:MM:SS / Weekday
Hour format	12hr AM/PM or 24hr
Calendar	MM/DD
Languages (weekday)	EN, FR, DE, ES, IT
Time signal	WWVB
Time zones	PST, MST, CST, EST, AST, NST
DST (daylight savings)	AUTO / OFF
WIRELESS SENSOR	
Dimensions (W x H x D)	13.5 x 15.5 x 5.5" (343.5 x 393.5 x 136 mm)
Weight	23.7 oz. (673g) with batteries
Battery power	3 x AA size 1.5V battery (Lithium battery recommended)
Frequency	915 MHz (North America)
Transmission	Every 12 seconds

OUTDOOR TEMPERATURE	
Temp. units	°F or °C
Display range	-40°F to 176°F (-40°C to 80°C)
Operating range	-40°F to 140°F (-40°C to 60°C)
Resolution	0.1°F or 0.1°C
Accuracy	+/- 1°F or 0.5°C typical @ 77°F (25°C)
Display modes	Current, Min and Max, Historical data for past 24 hours
Memory modes	Max & Min from last memory reset (with time stamp)
Alarm	Hi / Lo Temperature Alert
OUTDOOR HUMIDITY	
Display range	1% to 99% (< 1%: LO; > 99%: HI)
Operating range	1% to 99%
Resolution	1%
Accuracy	+/- 3% typical @ 77°F (25°C)
Display modes	Current, Min and Max, Historical data for past 24 hours
Memory modes	Max & Min from last memory reset (with time stamp)
Alarm	Hi / Lo Humidity Alert
RAIN GAUGE	
Units	mm and in
Range	0~393.7inches (0~9999mm)
Resolution	0.0157 in (0.4 mm)
Accuracy	+/- 7% or 1 tip (whichever is greater)
Display modes	Rainfall (Rate / Daily / Weekly / Monthly), Historical data for past 24 hours
Memory modes	Total rainfall from last memory reset
Alarm	Hi Rainfall Alert
WIND SPEED	
Wind speed units	mph, m/s, km/h, knots
Wind speed range	0~112mph, 50m/s, 180km/h, 97knots
Wind speed resolution	0.1mph or 0.1knot or 0.1m/s
Wind speed accuracy	< 5m/s: +/- 0.5m/s; > 5m/s: +/- 6%
Direction resolution	16
Display modes	Gust/average wind speed & direction, Historical data for past 24 hours
Memory modes	Max gust speed with direction (with time stamp)
Alarm	Hi Wind speed Alert (Average / Gust)
WEATHER INDEX	
Wind Chill range	-40~158°F (-40~70°C)
Heat Index range	78.8~122°F (26~50°C)
Indoor Dew Point range	-40~158°F (-40~70°C)

25. Warranty

FLIR Systems, Inc. warrants this Extech Instruments brand device to be free of defects in parts and workmanship for one year from date of shipment (a six month limited warranty applies to sensors and cables). If it should become necessary to return the instrument for service during or beyond the warranty period, contact the Customer Service Department for authorization. Visit the website www.extech.com for contact information. A Return Authorization (RA) number must be issued before any product is returned. The sender is responsible for shipping charges, freight, insurance and proper packaging to prevent damage in transit. This warranty does not apply to defects resulting from action of the user such as misuse, improper wiring, operation outside of specification, improper maintenance or repair, or unauthorized modification. FLIR Systems, Inc. specifically disclaims any implied warranties or merchantability or fitness for a specific purpose and will not be liable for any direct, indirect, incidental or consequential damages. FLIR's total liability is limited to repair or replacement of the product. The warranty set forth above is inclusive and no other warranty, whether written or oral, is expressed or implied.

Calibration, Repair, and Customer Care Services

FLIR Systems, Inc. offers repair and calibration services for the Extech Instruments products we sell. We offer NIST traceable calibration for most of our products. Contact our Customer Service Department for information on calibration service availability. Annual calibrations should be performed to verify meter performance and accuracy. Technical support and general customer service is also provided, refer to the contact information provided below.

Support Lines: U.S. (877) 239-8324

International: +1 (603) 324-7800

Technical Support: Option 3; E-mail: support@extech.com

Repair & Returns: Option 4; E-mail: repair@extech.com

Product specifications are subject to change without notice

Please visit our website for the most up-to-date information

www.extech.com

FLIR Commercial Systems, Inc., 9 Townsend West, Nashua, NH 03063 USA

ISO 9001 Certified

Copyright © 2017 FLIR Systems, Inc.

All rights reserved including the right of reproduction in whole or in part in any form

www.extech.com

Garantie

FLIR Systems, Inc. garantit que cet appareil Extech Instruments est exempt de défauts matériels et de fabrication pendant un an à partir de la date d'envoi (une garantie limitée de six mois s'applique aux capteurs et aux câbles). Si le renvoi de l'appareil pour réparation devient nécessaire durant ou après la période de garantie, contactez le service client pour autorisation. Pour obtenir les coordonnées, visitez le site Web suivant : www.extech.com. Un numéro d'autorisation de retour (AR) doit être délivré avant tout retour de produit. L'expéditeur prend à sa charge les frais d'expédition, le fret, l'assurance et l'emballage correct de l'appareil afin de prévenir toute détérioration durant le transport. Cette garantie ne s'applique pas aux dommages imputables à l'utilisateur, tels que l'usage impropre ou abusif, un mauvais câblage, une utilisation non conforme aux spécifications, un entretien ou une réparation incorrecte, ou toute modification non autorisée. FLIR Systems, Inc. déclinera spécifiquement toute garantie ou qualité marchande ou aptitude à l'emploi prévu, et ne sera en aucun cas tenu responsable pour tout dommage conséquent, direct, indirect ou accidentel. La responsabilité totale de FLIR est limitée à la réparation ou au remplacement du produit. La garantie définie ci-dessus est inclusive et aucune autre garantie, écrite ou orale, n'est exprimée ou implicite.

Calibrage, réparation et services après-vente

FLIR Systems, Inc. offre des services de calibrage et de réparation pour les produits Extech Instruments que nous commercialisons. Nous offrons l'étalonnage traçable NIST pour la plupart de nos produits. Contactez notre service clientèle pour obtenir des informations sur la disponibilité des services d'étalonnage. Un calibrage doit être effectué chaque année pour vérifier les performances et la précision du mètre. Nous offrons également une assistance technique et un service à la clientèle. Veuillez vous reporter aux coordonnées fournies ci-dessous.

Lignes d'assistance: États-Unis (877) 239-8324

International: +1 (603) 324-7800

Service d'assistance technique : Option 3 ; E-mail : support@extech.com

Réparations et retours : Option 4 ; E-mail : repair@extech.com

Les spécifications produit sont sujettes à modifications sans préavis.

Pour les toutes dernières informations, veuillez visiter notre site Web.

www.extech.com

FLIR Commercial Systems, Inc., 9 Townsend West, Nashua, NH 03063 USA

Certifié ISO 9001

Copyright © 2017 FLIR Systems, Inc.

Tous droits réservés, y compris la reproduction partielle ou totale sous quelque forme que ce soit.

www.extech.com

Garantía

FLIR Systems, Inc., garantiza este dispositivo marca Extech Instruments para estar libre de defectos en partes o mano de obra durante un año a partir de la fecha de embarque (se aplica una garantía limitada de seis meses para cables y sensores). Si fuera necesario regresar el instrumento para servicio durante o después del periodo de garantía, llame al Departamento de Servicio a Clientes para obtener autorización. Visite www.extech.com para información de contacto. Se debe expedir un número de Autorización de Devolución (AD) antes de regresar cualquier producto. El remitente es responsable de los gastos de embarque, flete, seguro y empaque apropiado para prevenir daños en tránsito. Esta garantía no se aplica a defectos resultantes de las acciones del usuario como el mal uso, alambrado equivocado, operación fuera de las especificaciones, mantenimiento o reparación inadecuada o modificación no autorizada. FLIR Systems, Inc., rechaza específicamente cualesquier garantías implícitas o factibilidad de comercialización o idoneidad para cualquier propósito determinado y no será responsable por cualesquier daños directos, indirectos, incidentales o consecuentes. La responsabilidad total de FLIR está limitada a la reparación o reemplazo del producto. La garantía precedente es inclusiva y no hay otra garantía ya sea escrita u oral, expresa o implícita.

Servicios de calibración, reparación y atención a clientes

FLIR Systems, Inc., ofrece servicios de reparación y calibración para los productos que vendemos de Extech Instruments. Ofrecemos calibración rastreada a NIST para la mayoría de nuestros productos, para información sobre la disponibilidad del servicio de calibración por favor llame a nuestro Departamento de Servicio al Cliente. Para verificar el funcionamiento y precisión se debe realizar la calibración anual. Además se provee Soporte Técnico y servicios generales al cliente, consulte la información de contacto en seguida.

Líneas de soporte: EE.UU. (877) 239-8324

Internacional: +1 (603) 324-7800

Soporte Técnico Opción 3; correo electrónico: support@extech.com

Reparación / Devoluciones: Opción 4; correo electrónico: repair@extech.com

Las especificaciones del producto están sujetas a cambios sin aviso

Por favor visite nuestra página en Internet para la información más actualizada

www.extech.com

FLIR Commercial Systems, Inc., 9 Townsend West, Nashua, NH 03063 USA

Certificado ISO 9001

Copyright © 2017 FLIR Systems, Inc.

Reservados todos los derechos, incluyendo el derecho de reproducción total o parcial en cualquier medio

www.extech.com