



KLS Illuminated SPDT/DPDT Pushbutton

NEW

Pushbutton



Features/Benefits

- Positive tactile feedback
- Momentary or Lock version
- SPDT & DPDT configuration
- Gold or silver contact materials
- Choices of color on LED illumination
- 3 different CAP styles & sizes
- CAP with printed or etched logo*

Typical Applications

- Audio/video system
- Vending machine
- Kiosks
- Network equipment

Specifications

FUNCTION: SPDT, DPDT
CONTACT ARRANGEMENT: N.C.
MOUNTING TYPE: Straight PCB terminals

Mechanical

OPERATING LIFE: 1,000,000 cycles
TOTAL TRAVEL: 2.2 mm
OPERATING FORCE: 200 ± 100 gf (SPDT)
300 ± 150 gf (DPDT)

Electrical

CONTACT RATING; See table on contact material
OPERATING LIFE: 200,000 cycles on both gold & silver plating
DIELECTRIC STRENGTH: 1,000 V AC for 1 min.
INSULATION RESISTANCE: 100 MΩ min. @ 500 VDC
INITIAL CONTACT RESISTANCE: 50 mΩ max. (silver contact)
100 mΩ max/ (gold contact)

Materials

CASE: PA66+70G33L (Black)
ACTUATOR: POM (White)
CAP: PC
SPRING: Black wire / Stainless steel
SPRING PLATE: Phosphor bronze
TERMINALS / CONTACT: Brass / Copper with silver or gold plated
TERMINAL SEAL: Epoxy

Operating Environment

OPERATING TEMPERATURE: -40°C to +85°C

Note: Specifications and materials listed above are for switches with standard options. For information on specific and custom switches, consult Customer Service Center.

Build-A-Switch

To order, simply select desired option from each category and place it in the appropriate box.

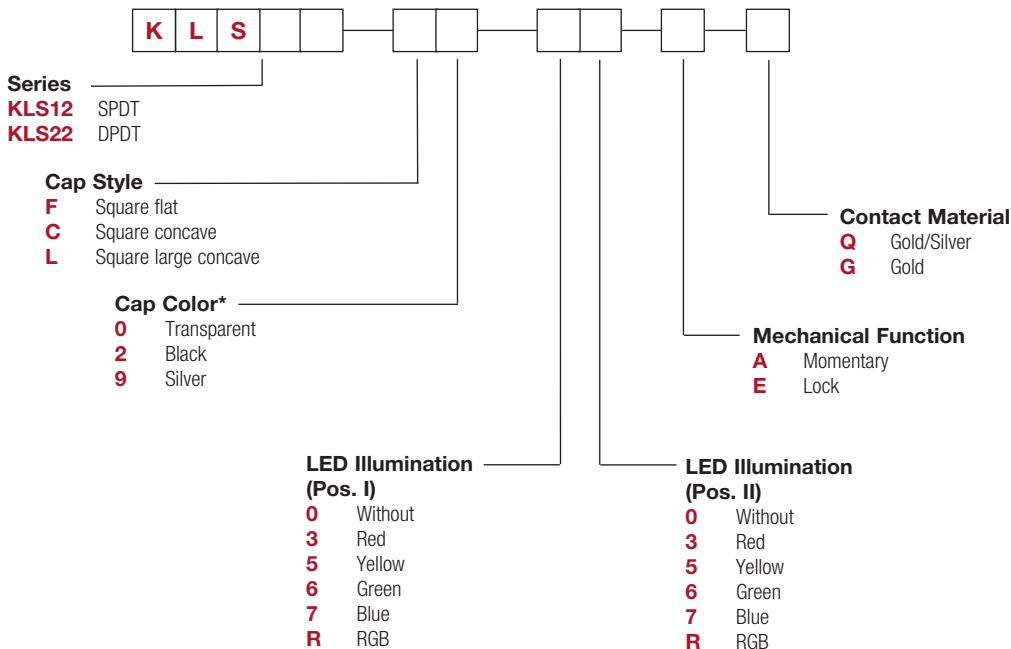

* For CAP with logo or symbol, please contact your sales representative.



NEW

KLS Illuminated SPDT/DPDT Pushbutton



A
Pushbutton

SERIES

KLS12

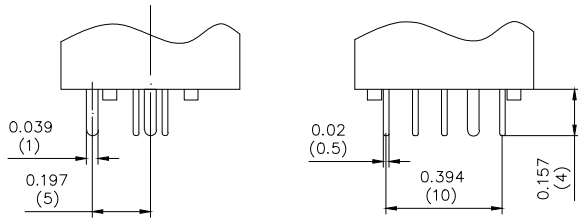

KLS22

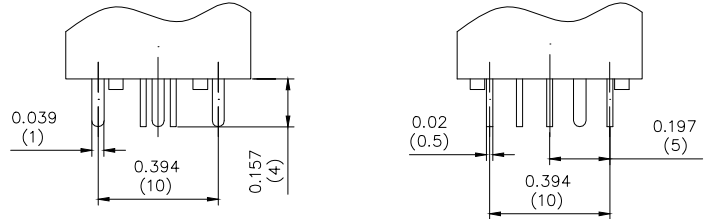

NO. POLES	MODEL NO.	SWITCH FUNCTION		CONNECTED TERMINALS		SCHEMATIC
		POS. 1	POS. 2	POS. 1	POS. 2	
SP	KLS12	ON	(ON)	1-3	1-2	
DP	KLS22	ON	(ON)	1-3,4-6	1-2,4-5	

()=Momentary

CAP

F SQUARE FLAT

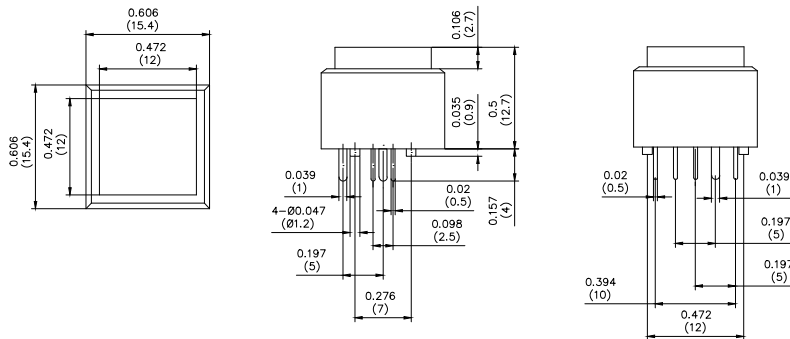

C SQUARE CONCAVE

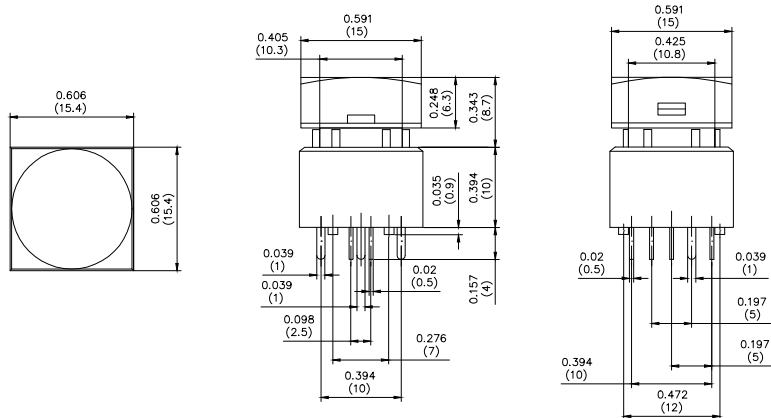

Third Angle Projection



8 Jul 20

D-173

Dimensions are shown: mm
Specifications and dimensions subject to change

www.ckswitches.com



KLS Illuminated SPDT/DPDT Pushbutton

NEW

Pushbutton

A

CAP

L SQUARE LARGE CONCAVE

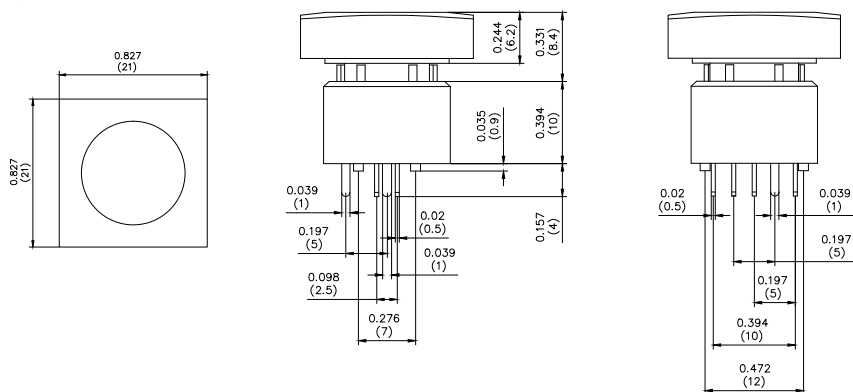

TERMINATION - PCB LAYOUT

KLS12

KLS22

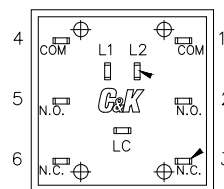
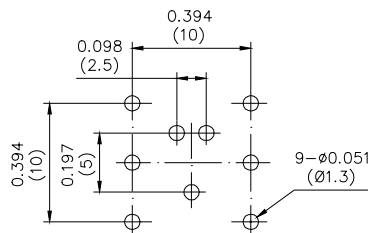
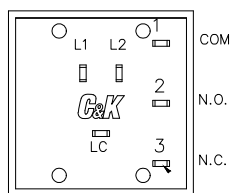
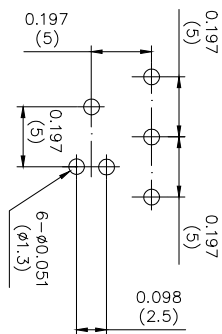

DUAL COLOUR

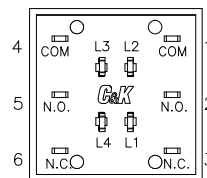
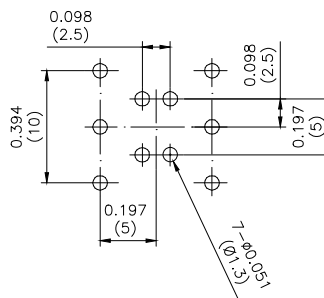
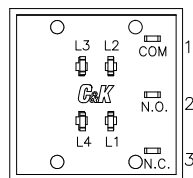
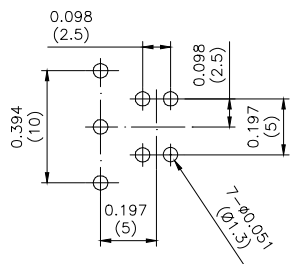

RGB



First Angle Projection



NEW

KLS Illuminated SPDT/DPDT Pushbutton



A
Pushbutton

LED CIRCUIT

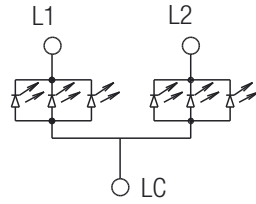

DUAL COLOUR

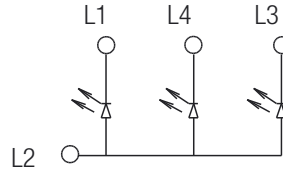

RGB

CONTACT MATERIAL

OPTION CODE	CONTACT MATERIAL	TERMINAL PLATING	RATING
Q	Copper / Gold ¹ Brass / Silver ²	Silver	25VDC 500 mA
G	Copper, Gold	Copper, Gold	28 VDC 100 mA

¹ Movable contact

² Stationary contact