

General Chip Inductor

CIL Series- CIL10 (1608/ EIA 0603)

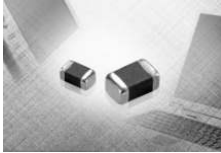

CIL Series has ferrite body and 100% Ag internal conductor. Also, the CIL series Inductors have excellent Q characteristics and free of cross talk.

FEATURES

- Magnetic shielding eliminates crosstalk, thus permitting higher mounting density.
- Excellent solderability and high heat resistance for either flow or reflow soldering.
- Monolithic structure for high reliability

APPLICATION

- Resonance circuits, PLL circuits, Noise suppression, etc.

SPECIFICATION

- Operating temperature range -40 to $+85^{\circ}\text{C}$
- Storage temperature range -10 to $+40^{\circ}\text{C}$

PRODUCT IDENTIFICATION

<u>CI</u>	<u>L</u>	<u>10</u>	<u>N</u>	<u>47N</u>	<u>K</u>	<u>N</u>	<u>C</u>
(1)	(2)	(3)	(4)	(5)	(6)	(7)	(8)

- (1) Chip Inductor
- (2) L:Ordinary type
- (3) Dimension
- (4) Material Code (N,J,Y,S)
- (5) Inductance(47N:0.047uH,2R2:2.2uH)
- (6) Tolerance(K: $\pm 10\%$, M: $\pm 20\%$)
- (7) Thickness option(N:Standard, A:Thinner than standard, B:Thicker than standard)
- (8) Packaging(C:paper tape, E:embossed tape)

RECOMMENDED SOLDERING CONDITION

REFLOW SOLDERING

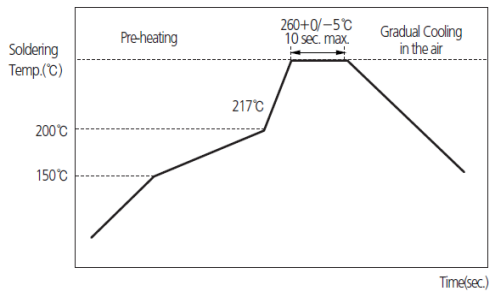

FLOW SOLDERING

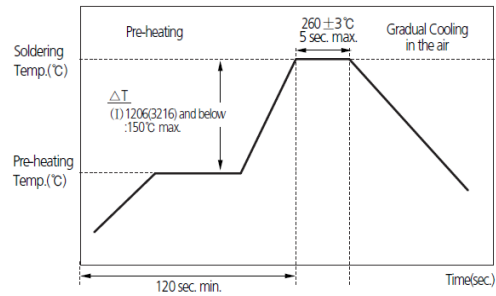

PACKAGING

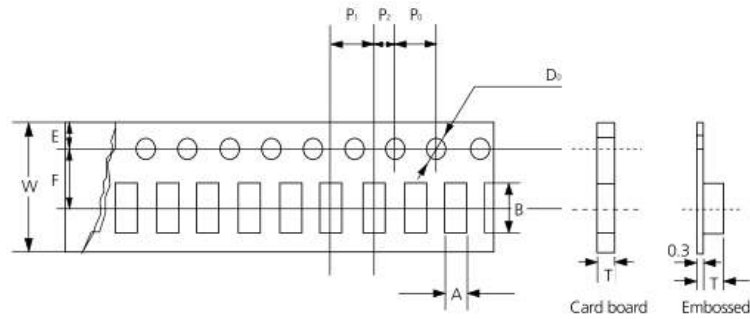

Type	03	05	10	21		22	31			32	41	43			
Tape	Card	Card	Card	Embossed		Card	Embossed		Embossed	Card	Embossed	Embossed			
Chip Thickness	0.3	0.5	0.8	0.85	1.0	1.25	0.85	1.2	0.6	0.8	1.1	0.85	1.3	1.5 (1.2)	1.5
Chip Cavity	A	0.40 ±0.06	0.65 ±0.1	1.0 ±0.2	1.5 ±0.2	1.5 ±0.2	1.45 ±0.1	2.39 ±0.10	1.9 ±0.2	1.9 ±0.2	1.9 ±0.2	2.0 ±0.2	2.9 ±0.2	1.9 ±0.2	3.5 ±0.2
	B	0.70 ±0.06	1.15 ±0.1	1.8 ±0.2	2.3 ±0.2	2.3 ±0.2	2.4 ±0.2	2.79 ±0.10	3.6 ±0.2	3.6 ±0.2	3.6 ±0.2	3.6 ±0.2	3.6 ±0.2	4.9 ±0.2	4.9 ±0.2
T max	0.45	0.8	1.1	1.5	2.0	2.0	0.95 ±0.1	1.80 ±0.10	1.15	1.4	1.4	1.1	1.55	1.8	1.78
W	8 ±0.2	8 ±0.2	8 ±0.2	8 ±0.2	8 ±0.2	8 ±0.2	8.0 ±0.3	8.0 ±0.3	8 ±0.2	8 ±0.2	8 ±0.2	8 ±0.2	8 ±0.2	12 ±0.2	12 ±0.2
F	3.5 ±0.05	3.5 ±0.05	3.5 ±0.05	3.5 ±0.05	3.5 ±0.05	3.5 ±0.05	3.5 ±0.05	3.5 ±0.05	3.5 ±0.05	3.5 ±0.05	3.5 ±0.05	3.5 ±0.05	3.5 ±0.05	5.5 ±0.05	5.5 ±0.05
E	1.75 ±0.1	1.75 ±0.1	1.75 ±0.1	1.75 ±0.1	1.75 ±0.1	1.75 ±0.1	1.75 ±0.1	1.75 ±0.1	1.75 ±0.1	1.75 ±0.1	1.75 ±0.1	1.75 ±0.1	1.75 ±0.1	1.75 ±0.1	1.75 ±0.1
P ₁	2 ±0.05	2 ±0.05	2 ±0.1	2 ±0.1	2 ±0.1	2 ±0.1	2 ±0.1	2 ±0.1	2 ±0.1	2 ±0.1	2 ±0.1	2 ±0.1	2 ±0.1	2 ±0.1	2 ±0.1
P ₂	2 ±0.1	2 ±0.1	2 ±0.1	2 ±0.1	2 ±0.1	2 ±0.1	2.0 ±0.1	2.0 ±0.05	2 ±0.1	2 ±0.1	2 ±0.1	2 ±0.1	2 ±0.1	2 ±0.1	2 ±0.1
P ₀	4.0 ±0.1	4.0 ±0.1	4.0 ±0.1	4.0 ±0.1	4.0 ±0.1	4.0 ±0.1	4.0 ±0.1	4.0 ±0.1	4.0 ±0.1	4.0 ±0.1	4.0 ±0.1	4.0 ±0.1	4.0 ±0.1	4.0 ±0.1	4.0 ±0.1
D ₀	∅1.5 ±0.1	∅1.5 ±0.1	∅1.5 ±0.1	∅1.5 ±0.1	∅1.5 ±0.1	∅1.5 ±0.1	∅1.5 ±0.1	∅1.5 ±0.1	∅1.5 ±0.1	∅1.5 ±0.1	∅1.5 ±0.1	∅1.5 ±0.1	∅1.5 ±0.1	∅1.5 ±0.1	∅1.5 ±0.1
Quantity /Reel (PCS)	10,000 (15,000)	10,000	4,000	4,000	3,000	2,000	4,000	2,000	4,000	3,000	3,000	4,000	2,500	2,000 (3,000)	1,000

• Reel dimensions

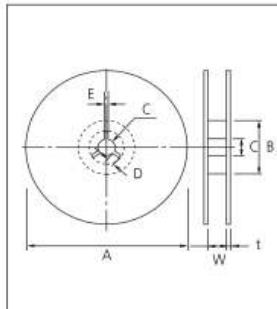

Symbol	Tape Width	A	B	C	D
7" Reel	8mm	∅180+0/-3	∅60+1/0	∅13±0.3	4±0.2
	12mm	∅180+0/-3	∅60+1/0	∅13±0.3	4±0.2
10" Reel	8mm	∅258+0/-3	∅80+1/0	∅13±0.3	4±0.2
	12mm	∅258+0/-3	∅80+1/0	∅13±0.3	4±0.2
13" Reel	8mm	∅330±2.0	∅80±1.0	∅13±0.3	4±0.2
	12mm	∅330±2.0	∅80±1.0	∅13±0.3	4±0.2

Symbol	Tape Width	E	W	t
7" Reel	8mm	2.0±0.5	9±0.5	1.2±0.2
	12mm	2.0±0.5	13±0.5	1.2±0.2
10" Reel	8mm	2.0±0.5	9±0.5	1.8±0.2
	12mm	2.0±0.5	13±0.5	1.8±0.2
13" Reel	8mm	2.0±0.5	9±0.5	2.2±0.2
	12mm	2.0±0.5	13±0.5	2.2±0.2

General Chip Inductor

1. Model :CIL1608 Type

2. Dimension

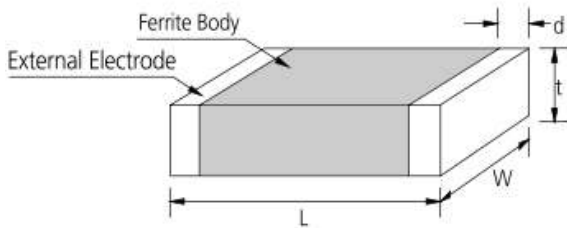

Type	Dimension [mm]			
	L	W	t	d
10	1.6±0.15	0.8±0.15	0.8±0.15	0.3±0.2

3. Description

Part No.	Thickness (mm)	Inductance (uH)	Q (Min.)	L,Q test frequency (MHz)	SRF (MHz) Min.	DC resistance (Ω) Max.	Rated current (mA) Max.
CIL10N47N	0.80±0.15	0.047±20%,10%	10	50	260	0.30	50
CIL10N56N	0.80±0.15	0.056±20%,10%	10	50	260	0.30	50
CIL10N68N	0.80±0.15	0.068±20%,10%	10	50	250	0.30	50
CIL10N82N	0.80±0.15	0.082±20%,10%	10	50	245	0.30	50
CIL10NR10	0.80±0.15	0.10±20%,10%	15	25	240	0.50	50
CIL10NR12	0.80±0.15	0.12±20%,10%	15	25	205	0.50	50
CIL10NR15	0.80±0.15	0.15±20%,10%	15	25	180	0.60	50
CIL10NR18	0.80±0.15	0.18±20%,10%	15	25	165	0.60	50
CIL10NR22	0.80±0.15	0.22±20%,10%	15	25	150	0.80	50
CIL10NR27	0.80±0.15	0.27±20%,10%	15	25	136	0.80	50
CIL10NR33	0.80±0.15	0.33±20%,10%	15	25	125	0.85	35
CIL10NR39	0.80±0.15	0.39±20%,10%	15	25	110	1.00	35
CIL10NR47	0.80±0.15	0.47±20%,10%	15	25	105	1.35	35
CIL10NR56	0.80±0.15	0.56±20%,10%	15	25	95	1.55	35
CIL10NR68	0.80±0.15	0.68±20%,10%	15	25	80	1.70	35
CIL10NR82	0.80±0.15	0.82±20%,10%	15	25	75	2.10	35
CIL10J1R0	0.80±0.15	1.0±20%,10%	35	10	70	0.60	25
CIL10J1R2	0.80±0.15	1.2±20%,10%	35	10	60	0.80	25
CIL10J1R5	0.80±0.15	1.5±20%,10%	35	10	55	0.80	25
CIL10J1R8	0.80±0.15	1.8±20%,10%	35	10	50	0.95	25
CIL10J2R2	0.80±0.15	2.2±20%,10%	35	10	45	1.15	15
CIL10J2R7	0.80±0.15	2.7±20%,10%	35	10	40	1.35	15

CIL10J3R3	0.80±0.15	3.3±20%,10%	35	10	38	1.55	15
CIL10J3R9	0.80±0.15	3.9±20%,10%	35	10	36	1.70	15
CIL10J4R7	0.80±0.15	4.7±20%,10%	35	10	33	2.10	15
CIL10Y5R6	0.80±0.15	5.6±20%,10%	35	4	22	1.55	5
CIL10Y6R8	0.80±0.15	6.8±20%,10%	35	4	20	1.70	5
CIL10Y8R2	0.80±0.15	8.2±20%,10%	35	4	18	2.10	5
CIL10Y100	0.80±0.15	10.0±20%,10%	35	2	17	2.55	5
CIL10Y120	0.80±0.15	12.0±20%,10%	35	2	15	2.75	5
CIL10S150	0.80±0.15	15.0±20%,10%	20	1	14	1.70	1
CIL10S180	0.80±0.15	18.0±20%,10%	20	1	13	1.85	1
CIL10S220	0.80±0.15	22.0±20%,10%	20	1	11	2.10	1
CIL10S270	0.80±0.15	27.0±20%,10%	20	1	10	2.75	1
CIL10S330	0.80±0.15	33.0±20%,10%	20	0.4	9	2.95	1

4.Characteristics data

(1) Impedance Characteristics

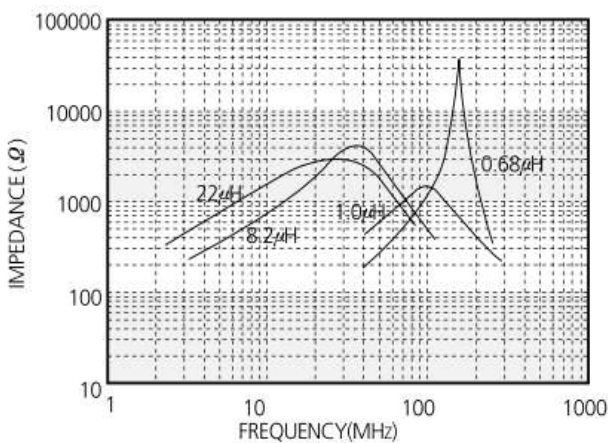

(2) Q Characteristics

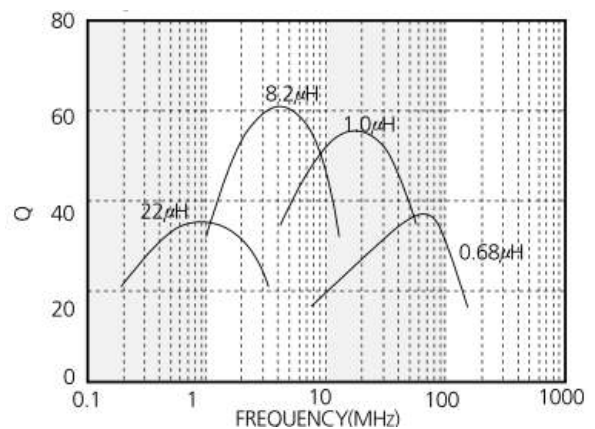

(3) DC Bias Characteristics

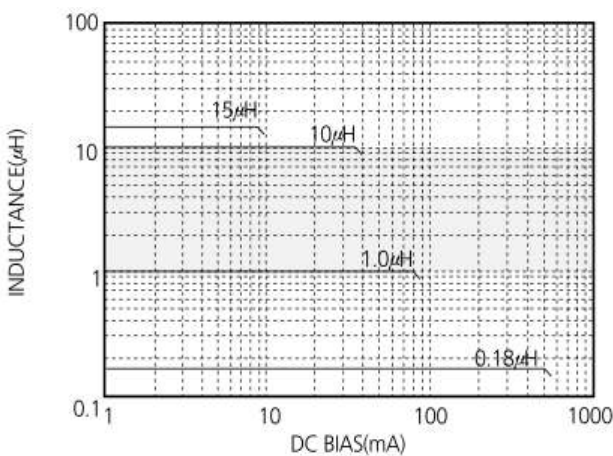

(4) Temperature Characteristics

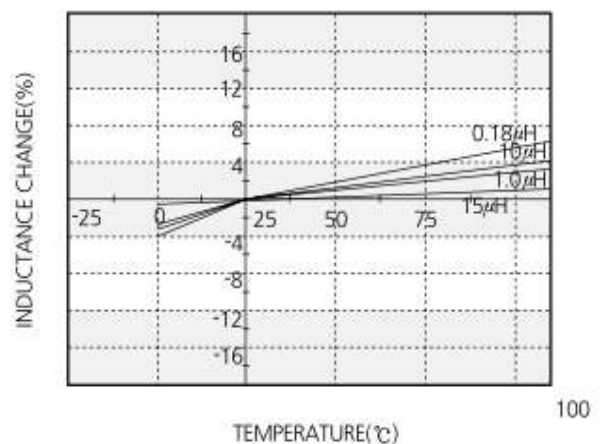

■ NOTICE :All specifications are subject to change without previous notice. Please contact with product representatives or engineers to check specifications.