



Micro Commercial Components

Micro Commercial Components
20736 Marilla Street Chatsworth
CA 91311
Phone: (818) 701-4933
Fax: (818) 701-4939

FR201 THRU FR207

Features

- Halogen free available upon request by adding suffix "-HF"
- Lead Free Finish/Rohs Compliant (Note1) ("P" Suffix designates Compliant. See ordering information)
- High Current Capability
- Fast Switching Speed For High Efficiency
- Epoxy meets UL 94 V-0 flammability rating
- Moisture Sensitivity Level 1

2 Amp Fast Recovery Rectifier 50 to 1000 Volts

Maximum Ratings

- Operating Temperature: -55°C to +150°C
- Storage Temperature: -55°C to +150°C

MCC Catalog Number	Device Marking	Maximum Recurrent Peak Reverse Voltage	Maximum RMS Voltage	Maximum DC Blocking Voltage
FR201	FR201	50V	35V	50V
FR202	FR202	100V	70V	100V
FR203	FR203	200V	140V	200V
FR204	FR204	400V	280V	400V
FR205	FR205	600V	420V	600V
FR206	FR206	800V	560V	800V
FR207	FR207	1000V	700V	1000V

DO-15

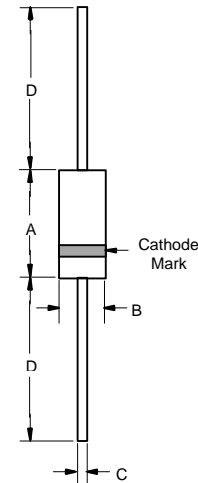

Electrical Characteristics @ 25°C Unless Otherwise Specified

Average Forward Current	$I_{F(AV)}$	2 A	$T_A = 55^\circ\text{C}$
Peak Forward Surge Current	I_{FSM}	60A	8.3ms, half sine
Maximum Instantaneous Forward Voltage	V_F	1.3V	$I_{FM} = 2.0\text{A}; T_A = 25^\circ\text{C}$
Maximum DC Reverse Current At Rated DC Blocking Voltage	I_R	5.0 μA 100 μA	$T_A = 25^\circ\text{C}$ $T_A = 100^\circ\text{C}$
I^2t Rating for fusing	I^2t	15A ² S	$t < 8.3\text{ms}$
Maximum Reverse Recovery Time	T_{rr}	150ns 250ns 500ns	$I_F = 0.5\text{A}, I_R = 1.0\text{A}, I_{rr} = 0.25\text{A}$
Typical Junction Capacitance	C_J	40pF	Measured at 1.0MHz, $V_R = 4.0\text{V}$

Notes: 1. High Temperature Solder Exemption Applied, see EU Directive Annex Notes 7.

DIM	DIMENSIONS				NOTE
	INCHES		MM		
A	.230	.300	5.80	7.60	
B	.104	.140	2.60	3.60	
C	.026	.034	.70	.90	
D	1.000	---	25.40	---	

FR201 thru FR207

Figure 1
Typical Forward Characteristics

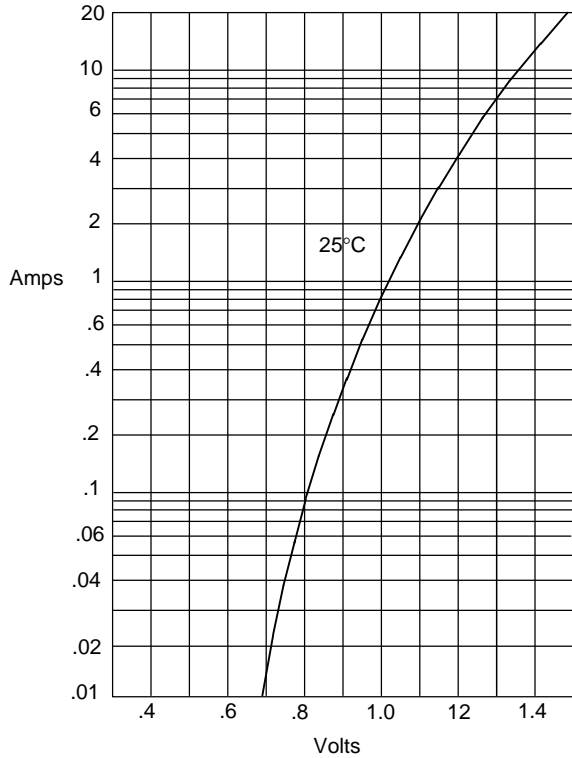

Instantaneous Forward Current - Amperes *versus*
Instantaneous Forward Voltage - Volts

Figure 2
Forward Derating Curve

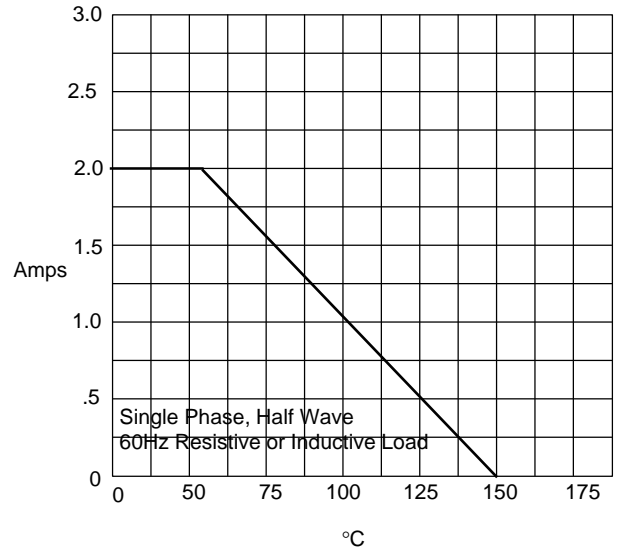

Average Forward Rectified Current - Amperes *versus*
Ambient Temperature - °C

Figure 3
Junction Capacitance

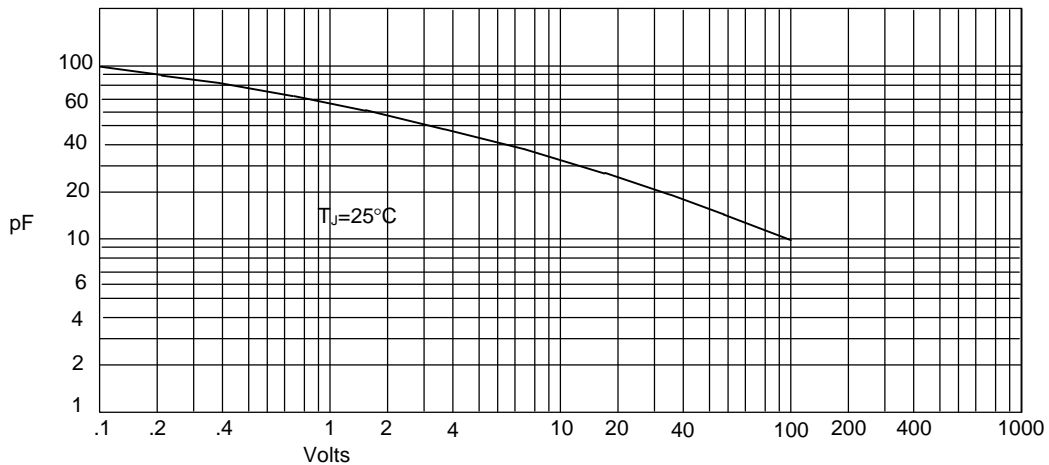

Junction Capacitance - pF *versus*
Reverse Voltage - Volts

Figure 4
Maximum Non-Repetitive Forward Surge Current

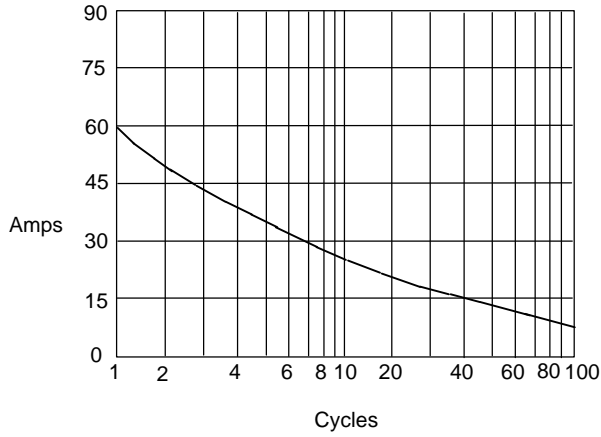

Peak Forward Surge Current - Amperes versus
Number Of Cycles At 60Hz - Cycles

Figure 5
Reverse Recovery Time Characteristic And Test Circuit Diagram

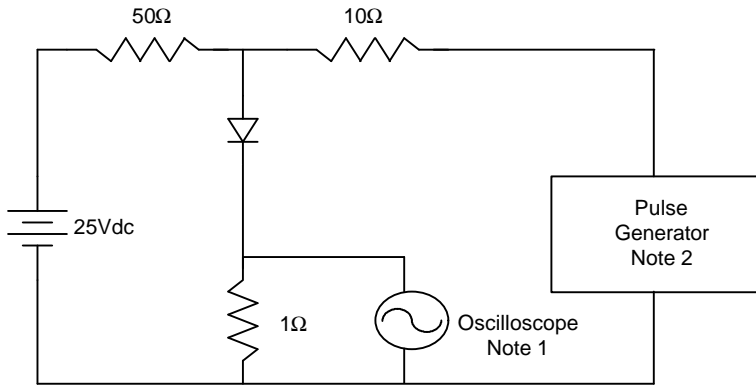

- Notes:
1. Rise Time = 7ns max.
Input impedance = 1 megohm, 22pF
 2. Rise Time = 10ns max.
Source impedance = 50 ohms
 3. Resistors are non-inductive

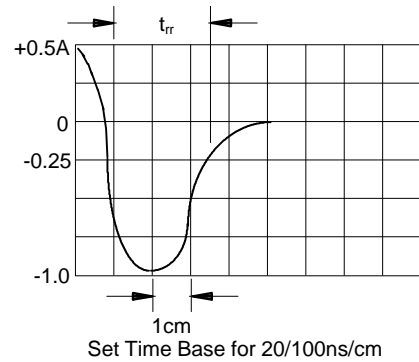



Micro Commercial Components

Ordering Information :

Device	Packing
Part Number-TP	Tape&Reel: 4Kpcs/Reel
Part Number-BP	Bulk: 25Kpcs/Carton

Note : Adding "-HF" suffix for halogen free, eg. Part Number-TP-HF

IMPORTANT NOTICE

Micro Commercial Components Corp. reserves the right to make changes without further notice to any product herein to make corrections, modifications, enhancements, improvements, or other changes. **Micro Commercial Components Corp.** does not assume any liability arising out of the application or use of any product described herein; neither does it convey any license under its patent rights, nor the rights of others. The user of products in such applications shall assume all risks of such use and will agree to hold **Micro Commercial Components Corp.** and all the companies whose products are represented on our website, harmless against all damages.

LIFE SUPPORT

MCC's products are not authorized for use as critical components in life support devices or systems without the express written approval of Micro Commercial Components Corporation.

CUSTOMER AWARENESS

Counterfeiting of semiconductor parts is a growing problem in the industry. Micro Commercial Components (MCC) is taking strong measures to protect ourselves and our customers from the proliferation of counterfeit parts. MCC strongly encourages customers to purchase MCC parts either directly from MCC or from Authorized MCC Distributors who are listed by country on our web page cited below. Products customers buy either from MCC directly or from Authorized MCC Distributors are genuine parts, have full traceability, meet MCC's quality standards for handling and storage. **MCC will not provide any warranty coverage or other assistance for parts bought from Unauthorized Sources.** MCC is committed to combat this global problem and encourage our customers to do their part in stopping this practice by buying direct or from authorized distributors.