

### GABRIELLA-MIDI-S

~10° spot beam with holder

#### TECHNICAL SPECIFICATIONS:

Dimensions	Ø 37.8 mm
Height	24.1 mm
Fastening	pin, screw
ROHS compliant	yes ⓘ

#### MATERIAL SPECIFICATIONS:

Component	Type	Material	Colour	Finish
C16193_GABRIELLA-MIDI-S	Single lens	PMMA	clear	
C16192_GABRIELLA-MIDI-HLD	Holder	PC	black	

#### ORDERING INFORMATION:

##### Quantities for one set:

Single lens	1
Holder	1





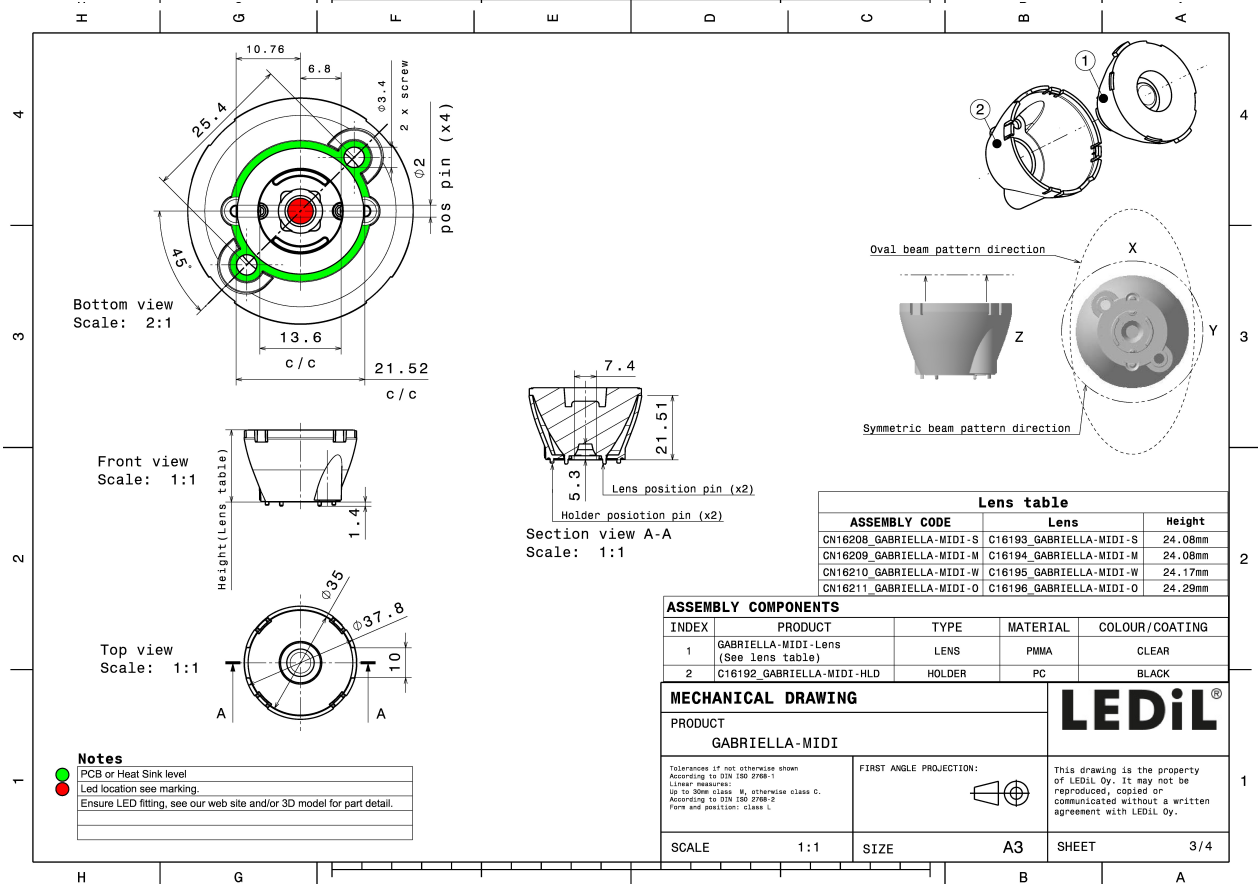
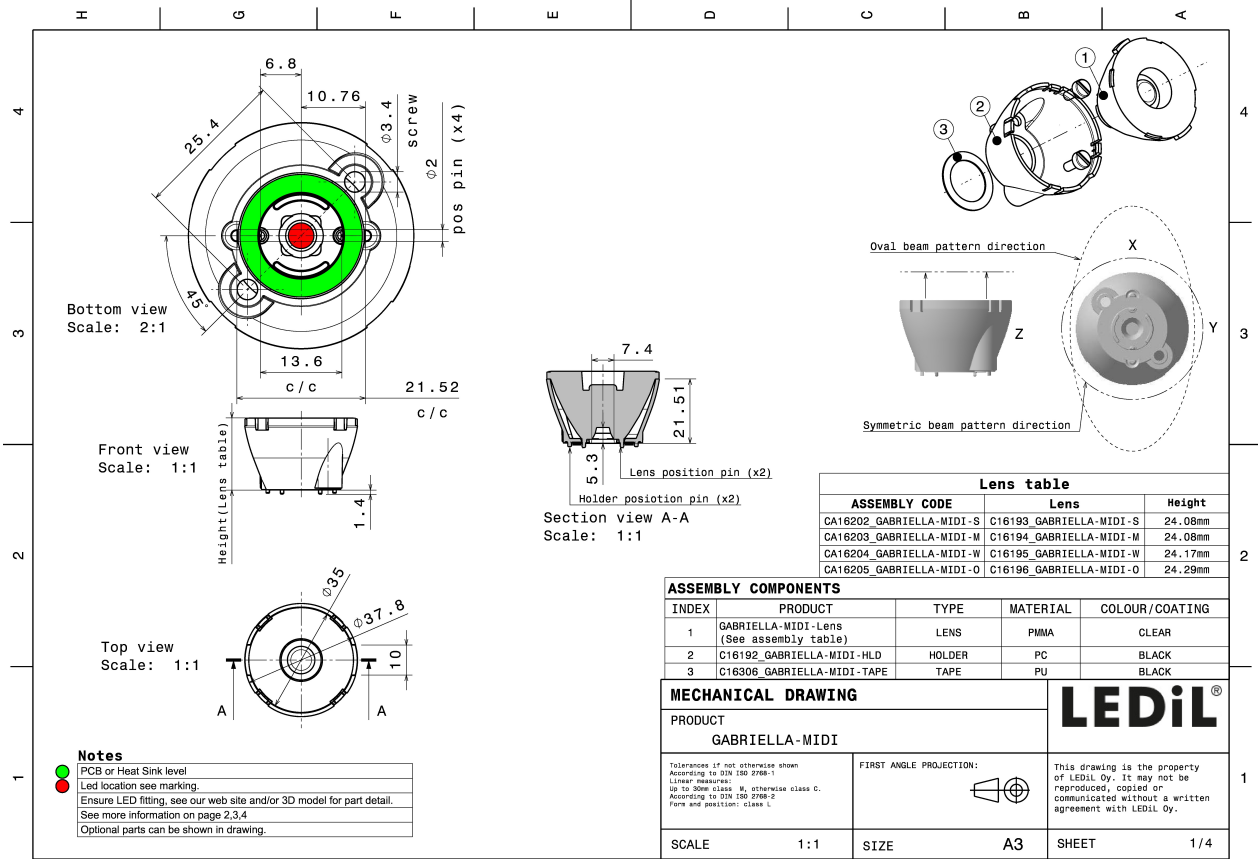

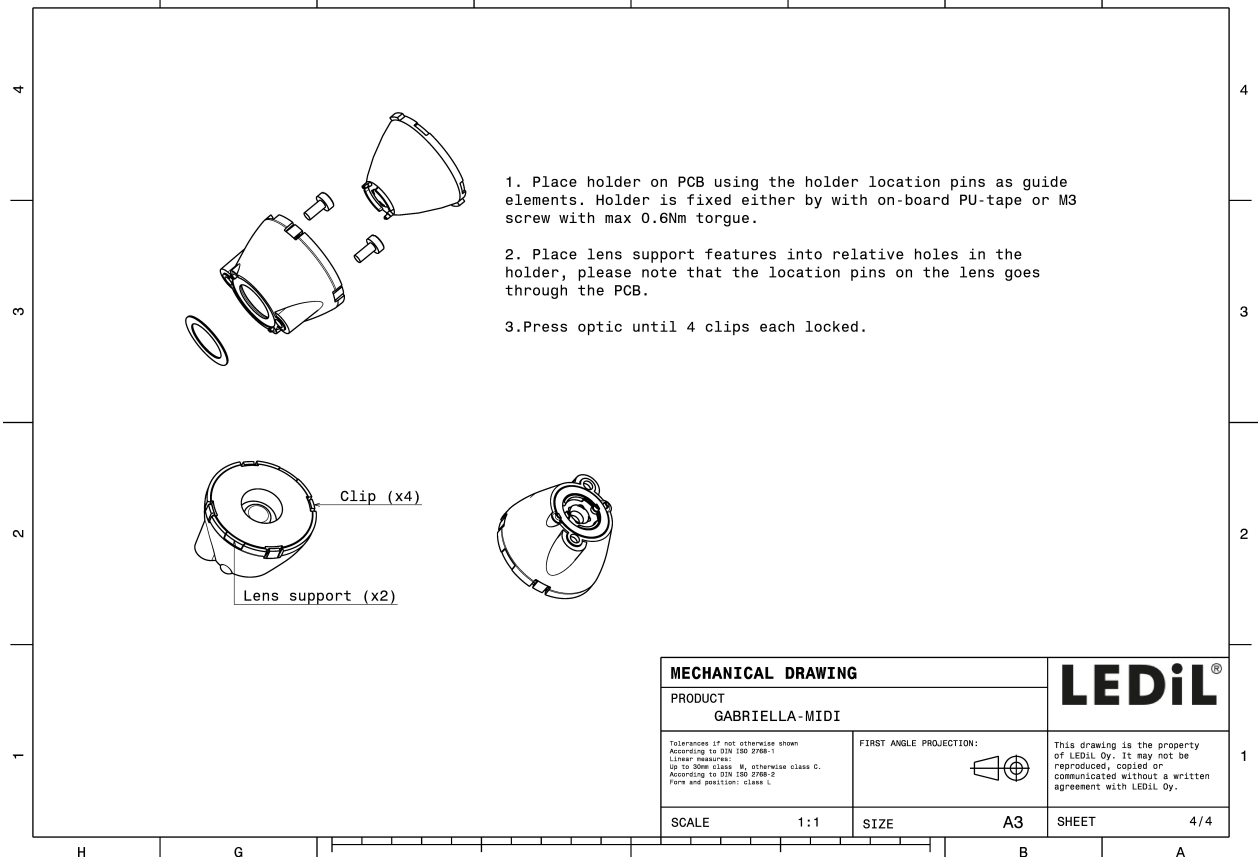
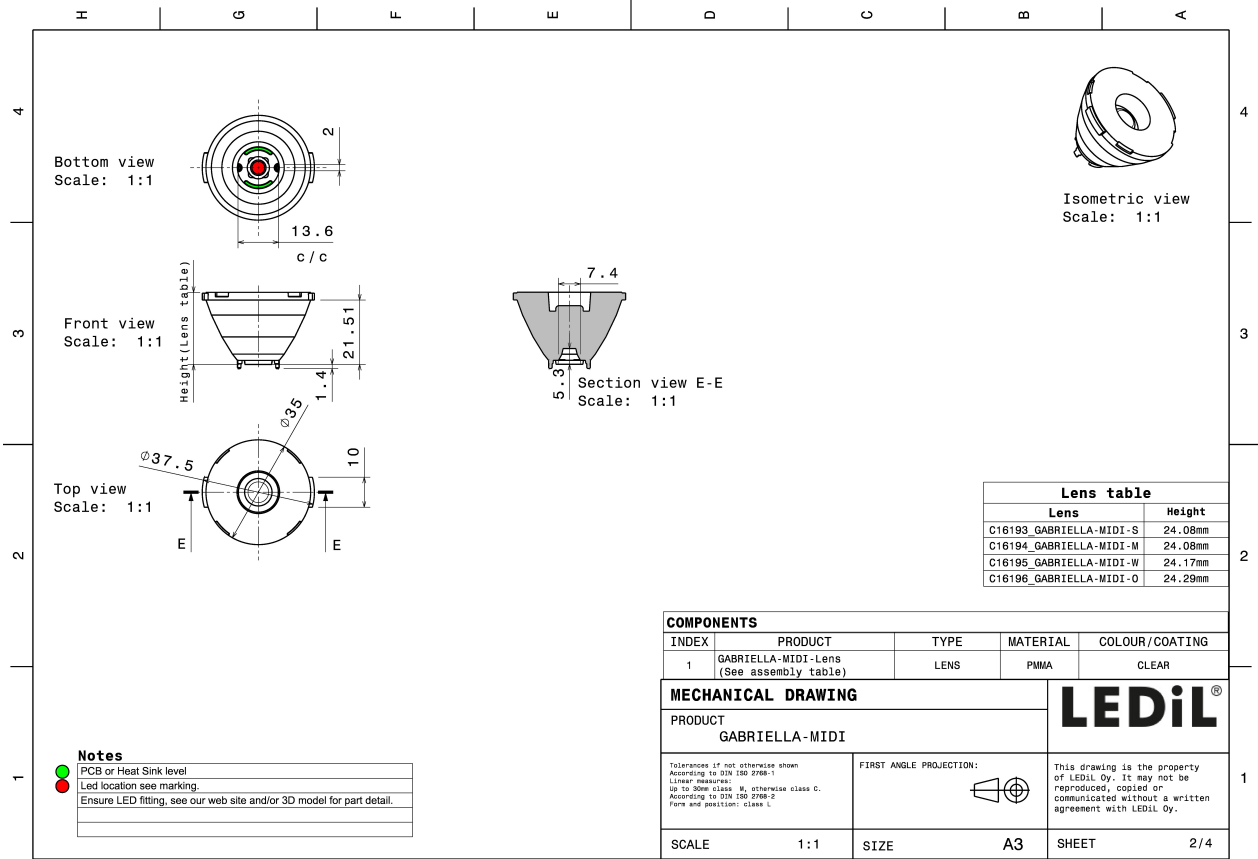
Component		Qty in box	MOQ	MPQ	Box weight (kg)
C16193_GABRIELLA-MIDI-S » Box size: 476 x 273 x 292 mm	Single lens	500	100	50	9.3
C16192_GABRIELLA-MIDI-HLD » Box size: 476 x 273 x 292 mm	Holder	500	100	50	3.6



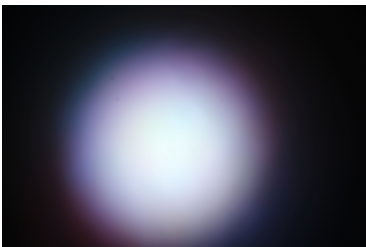
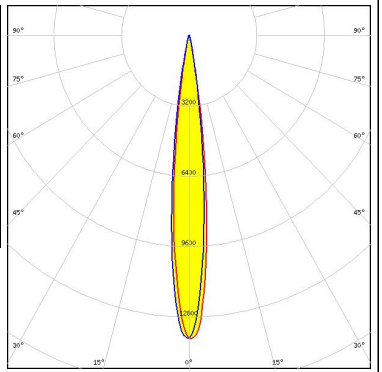
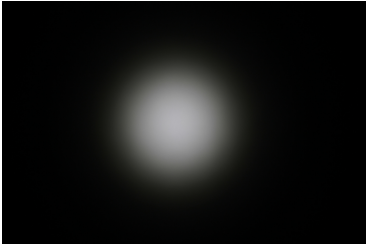
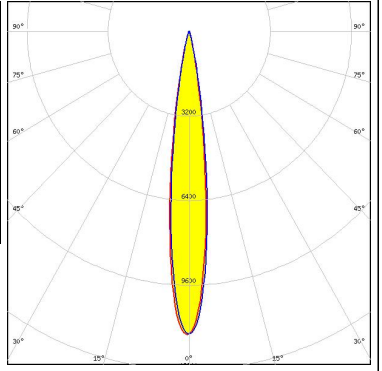

See also our general installation guide: [www.ledil.com/installation\\_guide](http://www.ledil.com/installation_guide)

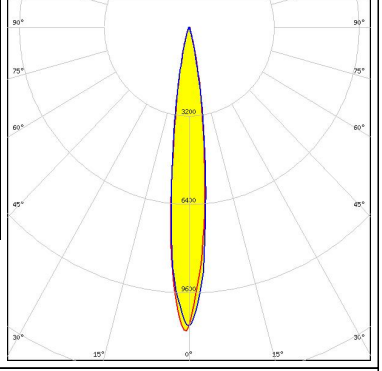
### PHOTOMETRIC DATA (MEASURED):

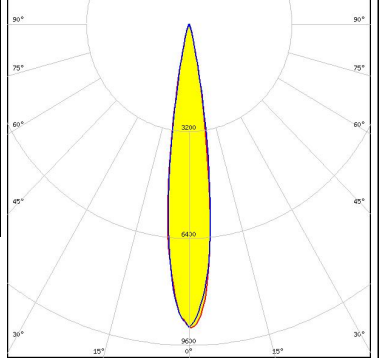
<p><b>CREE</b> LED</p> <p>LED XQ-E HD            FWHM / FWTM 13.0° / 22.0°            Efficiency 87 %            Peak intensity 13.8 cd/lm            LEDs/each optic 4            Light colour RGBW            Required components:</p>		
<p><b>LUMILEDS</b></p> <p>LED LUXEON 5050 Round LES            FWHM / FWTM 14.0° / 26.0°            Efficiency 91 %            Peak intensity 11.5 cd/lm            LEDs/each optic 1            Light colour White            Required components:</p>		
<p><b>LUMILEDS</b></p> <p>LED LUXEON 5052 RGBW            FWHM / FWTM 13.0° / 27.0°            Efficiency 89 %            Peak intensity 11 cd/lm            LEDs/each optic 1            Light colour RGBW            Required components:</p>		
<p><b>LUMILEDS</b></p> <p>LED LUXEON C            FWHM / FWTM 16.0° / 27.0°            Efficiency 86 %            Peak intensity 9.1 cd/lm            LEDs/each optic 4            Light colour RGBW            Required components:</p>		

### PHOTOMETRIC DATA (MEASURED):

#### LUMILEDS

LED LUXEON CZ  
 FWHM / FWTM 17.0° / 27.0°  
 Efficiency 89 %  
 Peak intensity 9.2 cd/lm  
 LEDs/each optic 4  
 Light colour RGBW  
 Required components:

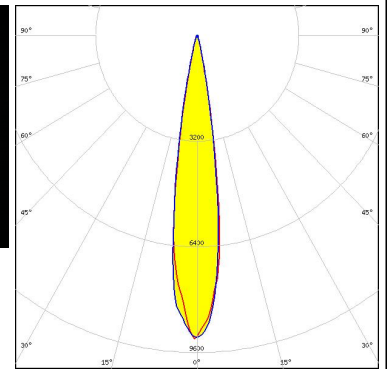
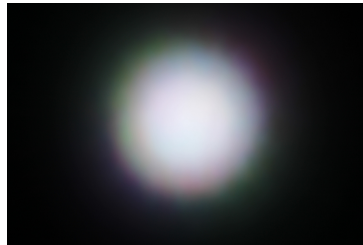

#### LUMILEDS

LED LUXEON V  
 FWHM / FWTM 12.0° / 22.0°  
 Efficiency 89 %  
 Peak intensity 15.1 cd/lm  
 LEDs/each optic 1  
 Light colour White  
 Required components:

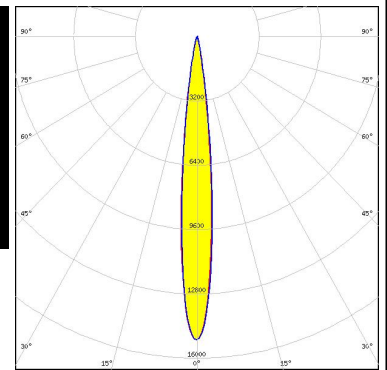
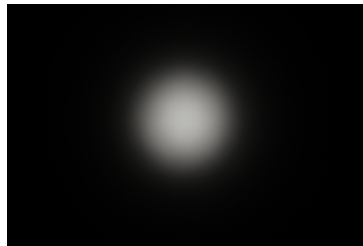

#### LUMINUS

LED SBM-40-RGBW  
 FWHM / FWTM 10.0° / 19.0°  
 Efficiency 89 %  
 Peak intensity 21 cd/lm  
 LEDs/each optic 1  
 Light colour White  
 Required components:

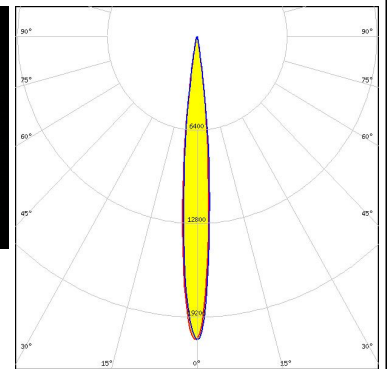





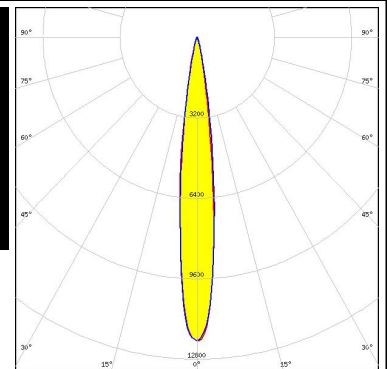
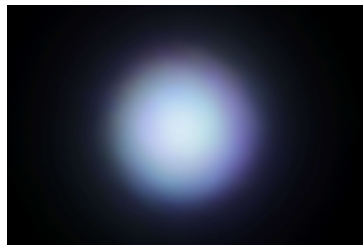

#### NICHIA

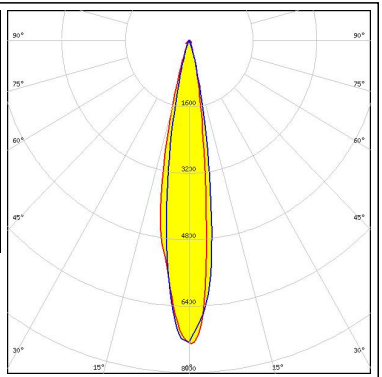
LED NCSxE17A  
 FWHM / FWTM 13.0° / 25.0°  
 Efficiency 92 %  
 Peak intensity 12 cd/lm  
 LEDs/each optic 4  
 Light colour RGBW  
 Required components:

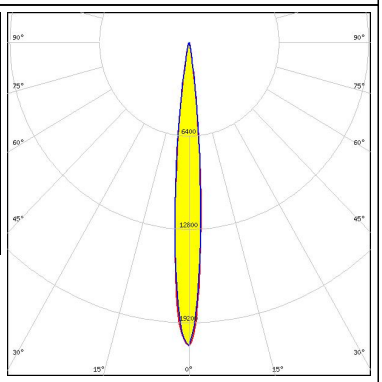

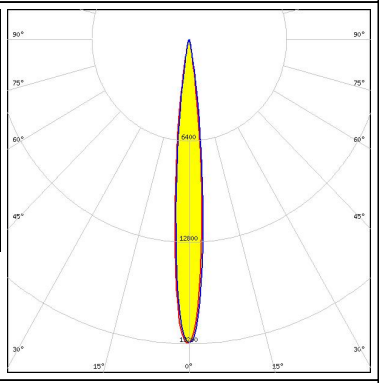
### PHOTOMETRIC DATA (MEASURED):

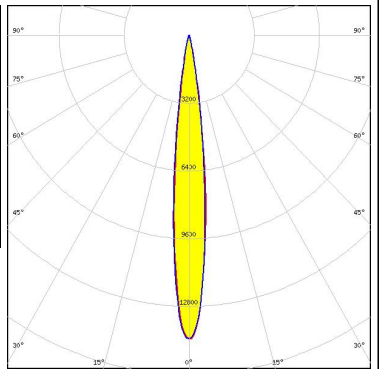
<p><b>NICHIA</b></p> <p>LED NVSW219F            FWHM / FWTM 17.0° / 31.0°            Efficiency 87 %            Peak intensity 7.3 cd/lm            LEDs/each optic 1            Light colour White            Required components:</p>		
<p><b>SEOUL SEMICONDUCTOR</b></p> <p>LED SPF05F0A            FWHM / FWTM 10.0° / 19.0°            Efficiency 89 %            Peak intensity 20.8 cd/lm            LEDs/each optic 4            Light colour RGBW            Required components:</p>		
<p><b>SEOUL SEMICONDUCTOR</b></p> <p>LED SPF05F0B            FWHM / FWTM 11.0° / 20.0°            Efficiency 90 %            Peak intensity 19.1 cd/lm            LEDs/each optic 4            Light colour RGBW            Required components:</p>		
<p><b>SEOUL SEMICONDUCTOR</b></p> <p>LED SPF05F0C            FWHM / FWTM 12.0° / 22.0°            Efficiency 89 %            Peak intensity 14.3 cd/lm            LEDs/each optic 4            Light colour RGBW            Required components:</p>		

### PHOTOMETRIC DATA (SIMULATED):

<p><b>CREE</b> LED</p> <p>LED XM-L RGBW (XMLDCL HD)</p> <p>FWHM / FWTM 14.0° / 25.0°</p> <p>Efficiency 93 %</p> <p>Peak intensity 13.5 cd/lm</p> <p>LEDs/each optic 1</p> <p>Light colour RGBW</p> <p>Required components:</p>	
<p><b>CREE</b> LED</p> <p>LED XM-L RGBW (XMLDCL HI)</p> <p>FWHM / FWTM 12.0° / 21.0°</p> <p>Efficiency 94 %</p> <p>Peak intensity 20.1 cd/lm</p> <p>LEDs/each optic 1</p> <p>Light colour RGBW</p> <p>Required components:</p>	
<p><b>CREE</b> LED</p> <p>LED XP-G2 HE</p> <p>FWHM / FWTM 12.0° / 22.0°</p> <p>Efficiency 92 %</p> <p>Peak intensity 17.9 cd/lm</p> <p>LEDs/each optic 1</p> <p>Light colour White</p> <p>Required components:</p>	
<p><b>NICHIA</b></p> <p>LED NV4x144A</p> <p>FWHM / FWTM 16.0° / 28.0°</p> <p>Efficiency 89 %</p> <p>Peak intensity 9.7 cd/lm</p> <p>LEDs/each optic 1</p> <p>Light colour White</p> <p>Required components:</p>	



### PHOTOMETRIC DATA (SIMULATED):

#### OSRAM Opto Semiconductors

LED DURIS E 5050 (GW J9LHS1.4M)  
 FWHM / FWTM 14.0° / 24.0 + 26.0°  
 Efficiency 93 %  
 Peak intensity 13.1 cd/lm  
 LEDs/each optic 1  
 Light colour RGBW  
 Required components:

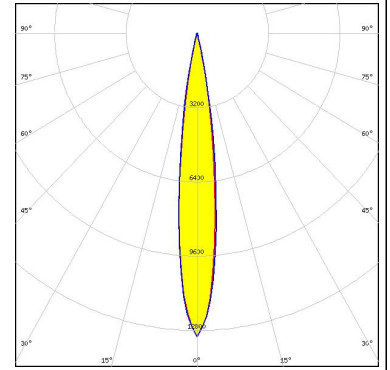

#### OSRAM Opto Semiconductors

LED Duris S8  
 FWHM / FWTM 14.0° / 25.0°  
 Efficiency 92 %  
 Peak intensity 12.8 cd/lm  
 LEDs/each optic 1  
 Light colour White  
 Required components:

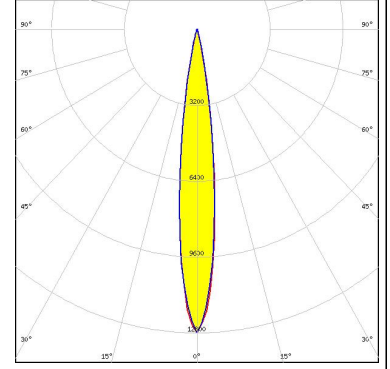

#### OSRAM Opto Semiconductors

LED SFH 4717AS  
 FWHM / FWTM 11.0° / 21.0°  
 Efficiency 91 %  
 LEDs/each optic 1  
 Light colour IR  
 Required components:

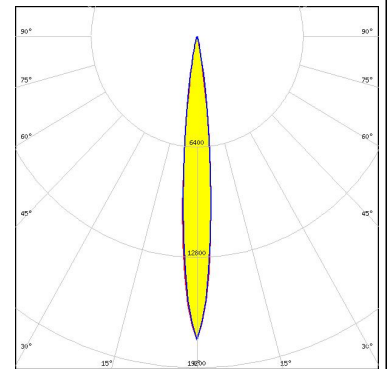
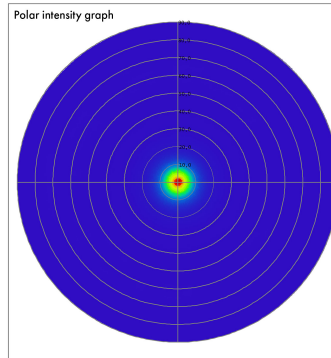

### GENERAL INFORMATION:

NOTE: The typical beam angle will be changed by different color, chip size and chip position tolerance. The typical total beam angle is the full angle measured where the luminous intensity is half of the peak value.

### MATERIALS:

As part of our continuous research and improvement processes, and to ensure the best possible quality and availability of our products, LEDiL reserves the right to change material grades without notice.

### PRODUCT DATA USER AGREEMENT AND DISCLAIMER:

The measured data in the provided downloadable LEDiL Product Datasheets and Mechanical 2D-Drawings is rounded and provided as reference for planning. LEDiL Oy's optical specifications have been verified by conducting performance testing of the products in accordance with the company's quality system. The reported data are averaged results of multiple measurements with typical variation. LEDiL Oy reserves the right to without prior notification make changes and improvements to its products.

LEDiL Oy assumes neither warranty, nor guarantee nor any other liability of any kind for the contents and correctness of the provided data. The provided data has been generated with highest diligence but the provided data may in reality not represent the complete possible variation range of all intrinsic parameters. Therefore, in certain cases a deviation from the provided data could occur.

LEDiL Oy reserves the right to undertake technical changes of its products without further notification which could lead to changes in the provided data. LEDiL Oy assumes no liability of any kind for the possible deviation from any provided data or any other damage resulting from the usage of the provided data.

The user agrees to this disclaimer and user agreement with the download or usage of the provided files.

#### LEDiL Oy

Joensuunkatu 13  
FI-24240 SALO  
Finland

#### LEDiL Inc.

228 West Page Street  
Suite D  
Sycamore IL 60178  
USA

#### Ledil Optics Technology (Shenzhen) Co., Ltd.

# 405 , Block B  
Casic Motor Building  
Shenzhen 518057  
P.R.CHINA

#### Local sales and technical support

[www.ledil.com/  
where\\_to\\_buy](http://www.ledil.com/where_to_buy)

#### Shipping locations

Salo, Finland  
Hong Kong, China

#### Distribution Partners

[www.ledil.com/  
where\\_to\\_buy](http://www.ledil.com/where_to_buy)