

























Plastic, double, turret head, type XCSTE, locking without power, 1/2" NPT conduit

Type of switch	With interlocking, locking by electromagnet ▲		
Supply voltage of electromagnet	24 Vac or Vdc	120 Vac or Vdc	230 Vac or Vdc
N.C.+N.O. break before make, slow break +★	 XCSTE5313 	XCSTE5333 	XCSTE5343 
N.O.+N.C. break before make, slow break +	 XCSTE6313 	XCSTE6333 	XCSTE6343 
N.C.+N.C. slow break +	 XCSTE7313 	XCSTE7333 	XCSTE7343 
Weight (oz.)	13 (0.360kg)	13 (0.360 kg)	13 (0.360 kg)

Plastic, turret head, type XCSTE, locking with power, 1/2" NPT conduit

Type of switch	With interlocking, locking by electromagnet ▲		
Supply voltage of electromagnet	24 Vac or Vdc	120 Vac or Vdc	230 Vac or Vdc
N.C.+N.O. break before make, slow break +★	 XCSTE5513 	XCSTE5533 	XCSTE5543 
N.O.+N.C. break before make, slow break +	 XCSTE6513 	XCSTE6533 	XCSTE6543 
N.C.+N.C. slow break +	 XCSTE7513 	XCSTE7533 	XCSTE7543 
Weight (oz.)	13 (0.360kg)	13 (0.360 kg)	13 (0.360 kg)

■90° increments throughout 360°

+Schematic diagrams shown represent the contact states while in the actuating key is fully inserted and engaged in the head of the switch.

★The N.O. contacts will close after the N.C. contacts open. They do not change state simultaneously.

▲A special tool included with the switch enables the forced opening of the interlocking device. This allows the N.C. safely contacts to be opened and the actuating key withdrawn.

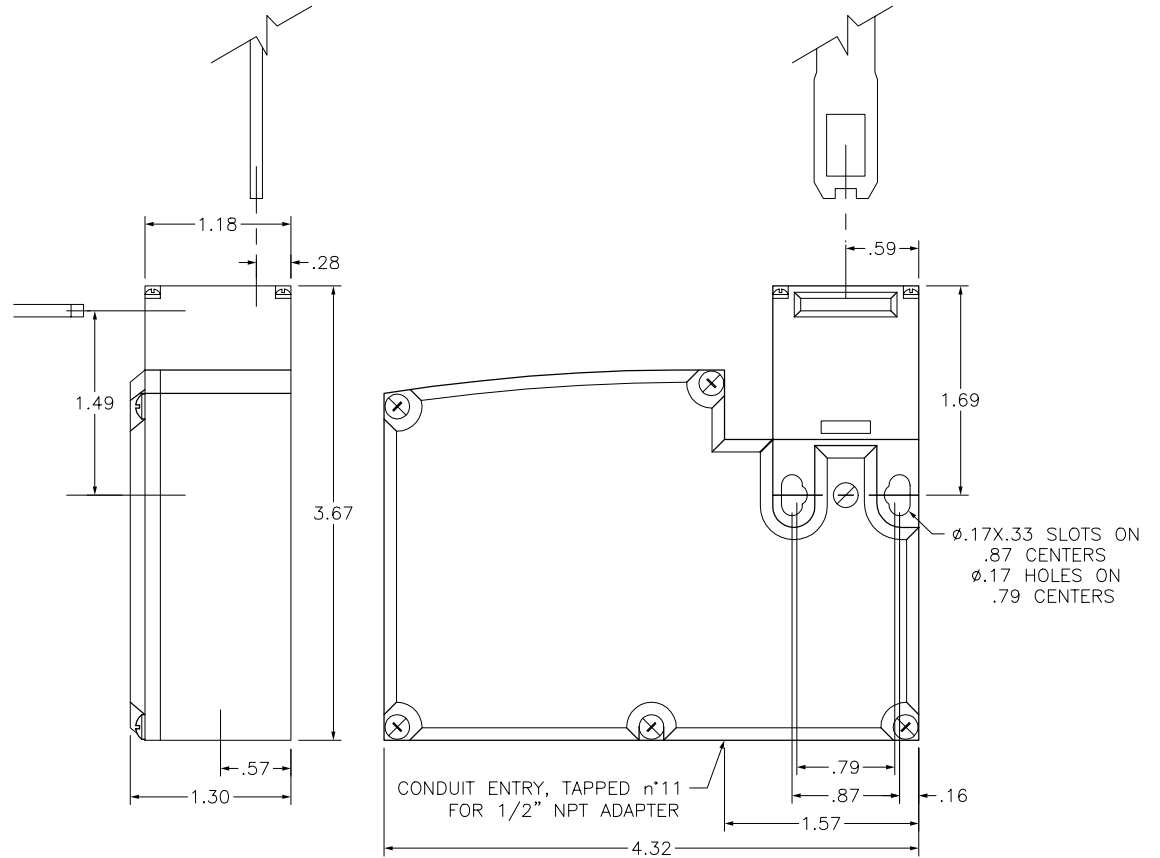

"THE SQUARE D COMPANY HAS PROPRIETARY RIGHTS TO THE INFORMATION CONTAINED HEREON. THIS INFORMATION REMAINS THE PROPERTY OF SQUARE D COMPANY AND MAY BE USED ONLY IN CONFORMANCE WITH INSTRUCTIONS ISSUED BY SQUARE D COMPANY. USER SHOULD VERIFY DRAWINGS ARE TO THE LATEST/CURRENT REVISION PRIOR TO INCORPORATING IN A DESIGN FILE."

DO NOT SCALE DRAWING
UNLESS OTHERWISE SPECIFIED DIMENSIONS ARE IN INCHES

THIRD ANGLE PROJECTION 
TOLERANCES
UNLESS OTHERWISE SPECIFIED
2 PLACE DECIMALS ± .01

XCSTE SAFETY INTERLOCK SWITCHES
XCSTE5313, XCSTE5333, XCSTE6313, XCSTE6333, XCSTE6343,
XCSTE7313, XCSTE7333, XCSTE7343, XCSTE5513, XCSTE5533,
XCSTE5543, XCSTE6513, XCSTE6533, XCSTE6543, XCSTE7513,
XCSTE7533, XCSTE7543

 **SQUARE D COMPANY**

DWG# XCSTE_OUTLINE_001
NO.