

REVISIONS				
ZONE	REV	DESCRIPTION	DATE	APPROVED

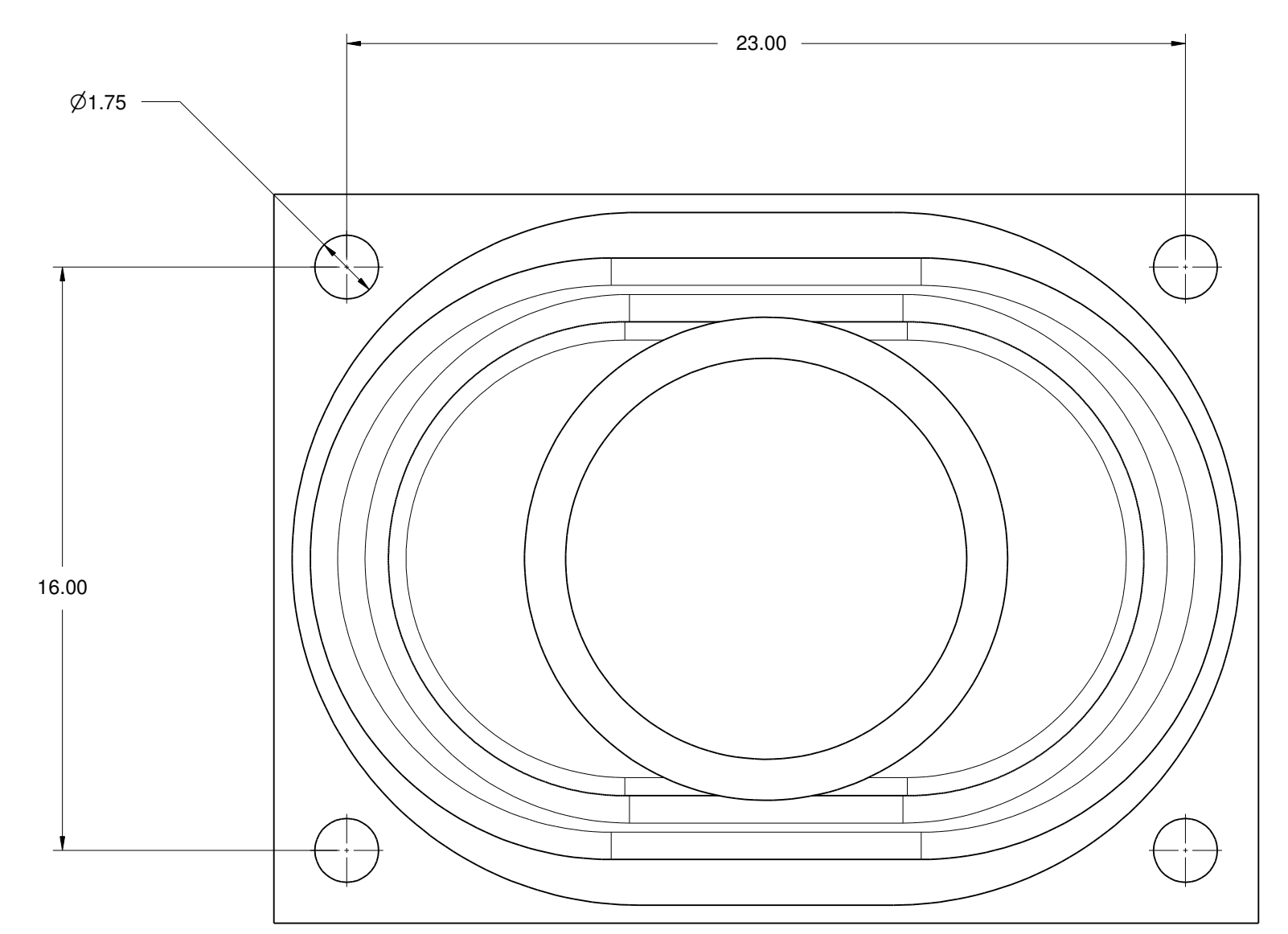
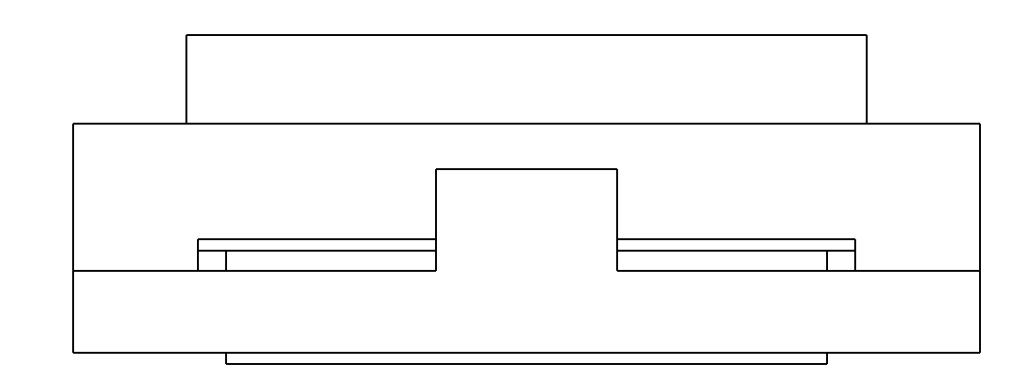
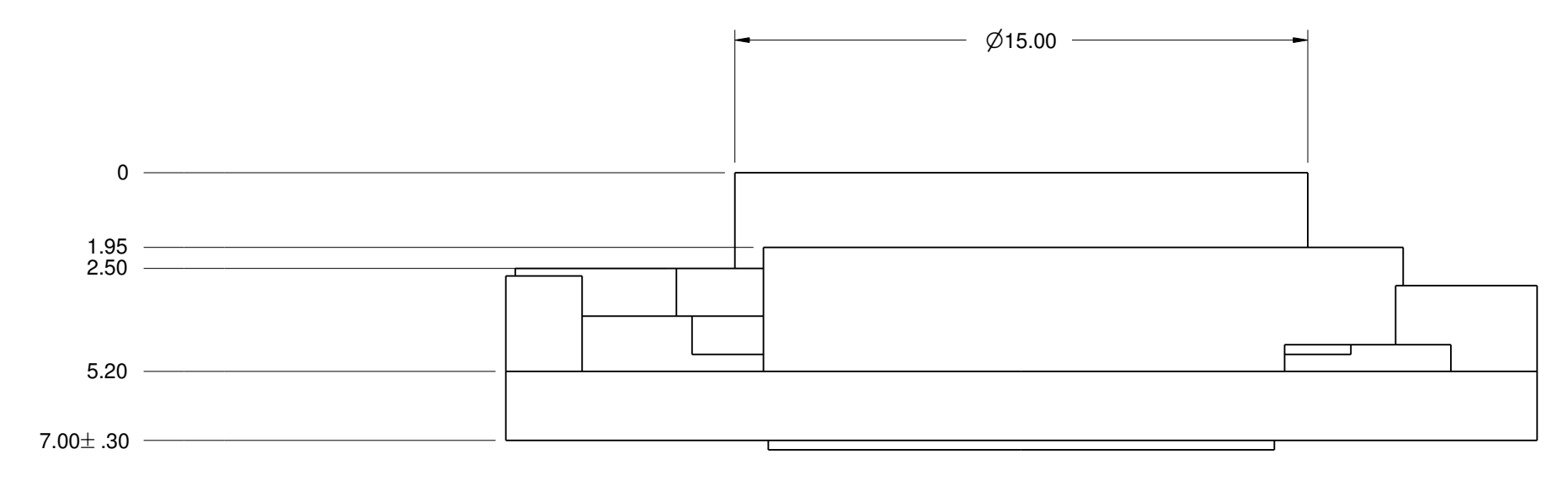
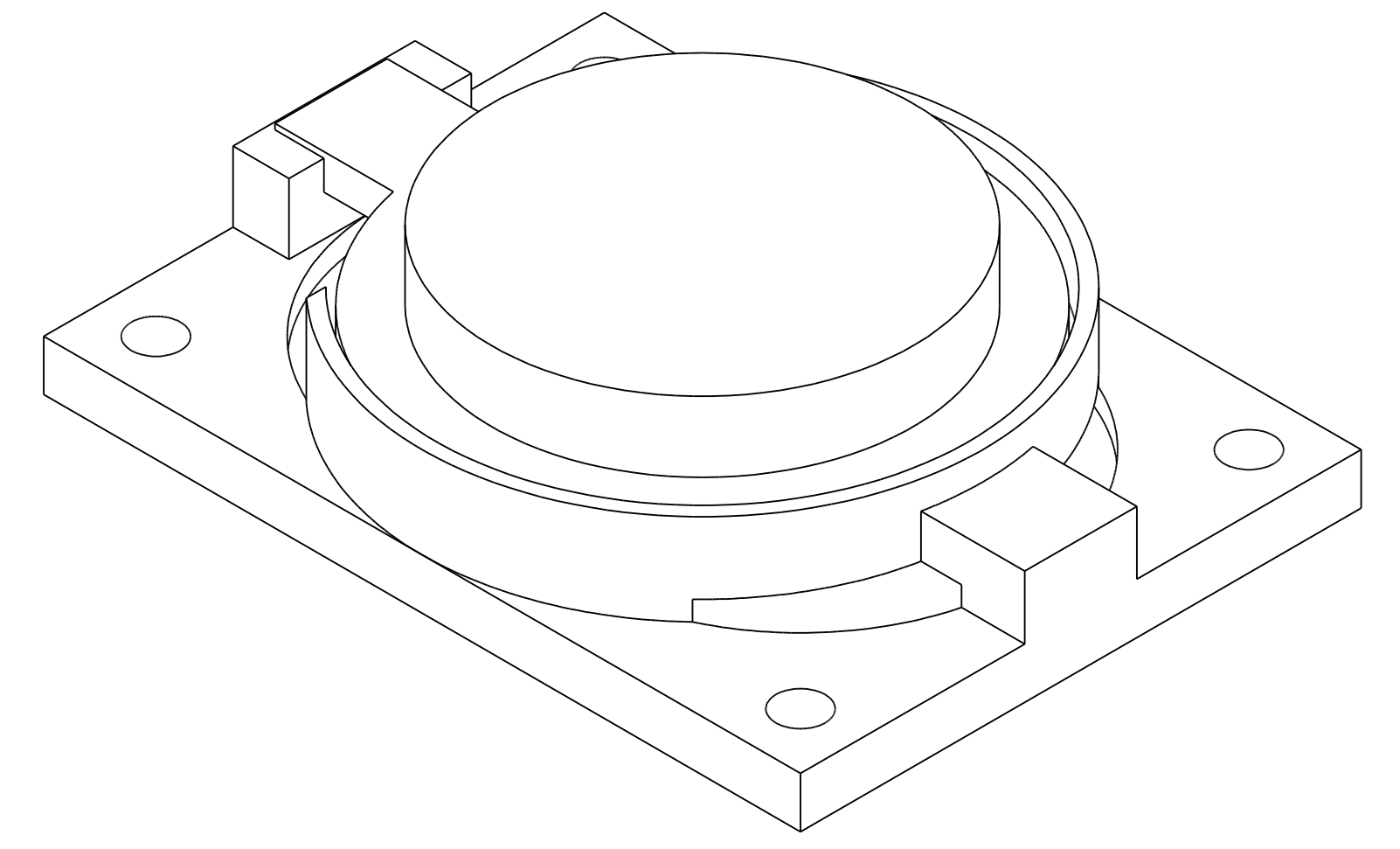
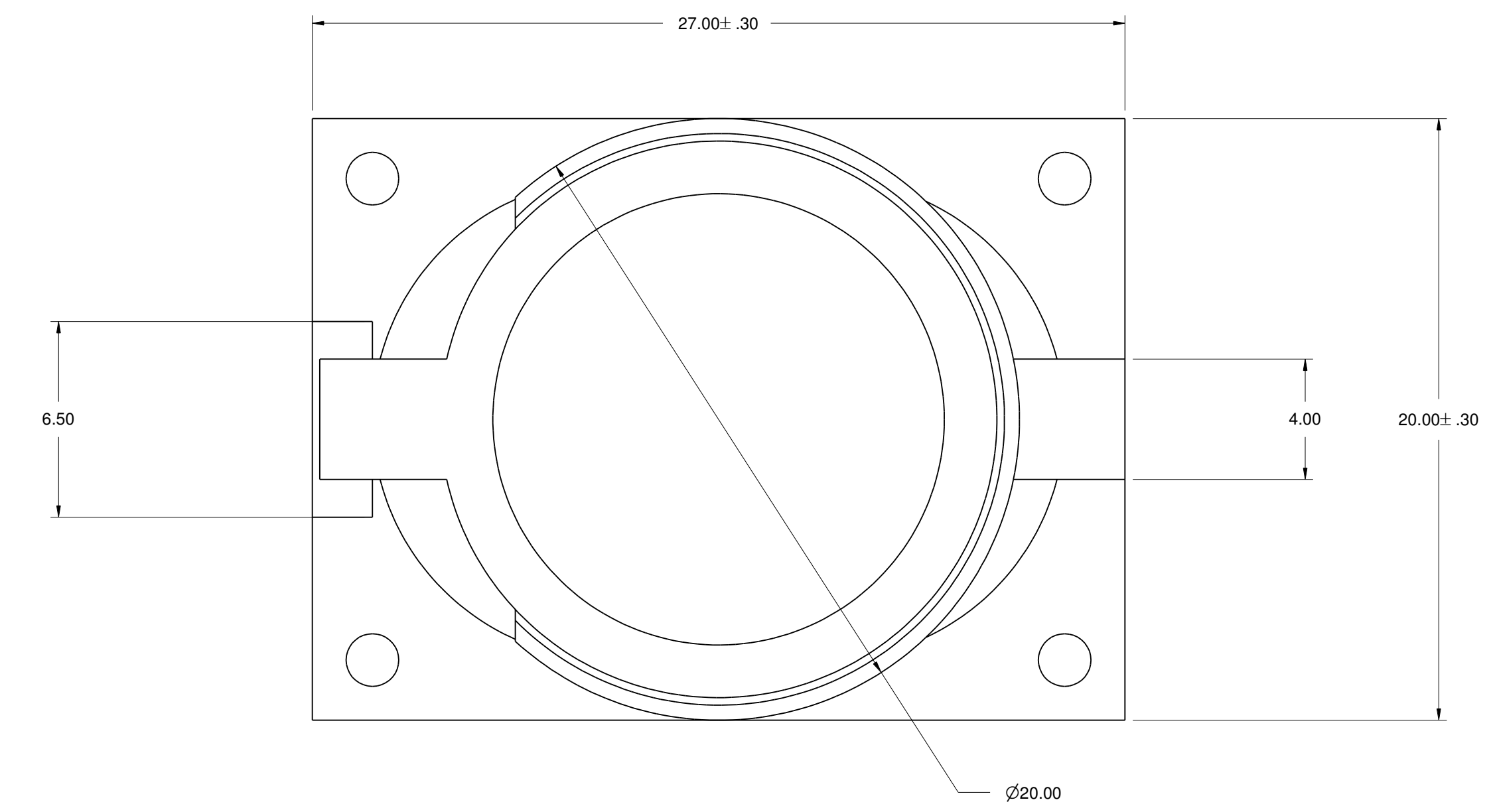

ALL TOLERANCES +/- .5MM UNLESS NOTED

SIZE	FSCM NO.	DWG NO.	REV
D		SP-2707Y	
SCALE	1:1	SHEET	1 OF 1