

NHD-0220DZ-NSW-FBW

Character Liquid Crystal Display Module

NHD- Newhaven Display
0220- 2 Lines x 20 Characters
DZ- Model
N- Transmissive
SW- Side White LED Backlight
F- FSTN, Negative
B- 6:00 Optimal View
W- Wide Temperature
RoHS Compliant

Newhaven Display International, Inc.

2661 Galvin Ct.

Elgin IL, 60124

Ph: 847-844-8795

Fax: 847-844-8796

www.newhavendisplay.com

nhtech@newhavendisplay.com

nhsales@newhavendisplay.com

Document Revision History

Revision	Date	Description	Changed by
0	10/11/07	Initial Release	-
1	2/3/10	User Guide Reformat	BE
2	3/1/11	Alternate controller information updated	AK
3	5/5/11	Electrical characteristics updated	AK
4	5/28/14	Drawing, electrical, and optical characteristics updated	AK
5	8/22/17	Electrical Characteristics Updated	SB
6	12/12/19	Electrical & Backlight Characteristics Updated	SB
7	4/6/20	Backlight Characteristics Updated	SB
8	6/16/20	Updated 2D Mechanical Drawing, Quality Information	AS

Functions and Features

- 2 lines x 20 characters
- Built-in controller (ST7066U)
- +5.0V Power Supply
- 1/16 duty, 1/5 bias
- RoHS compliant

SYMBOL	REVISION	DATE

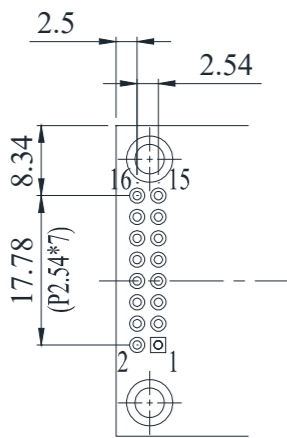
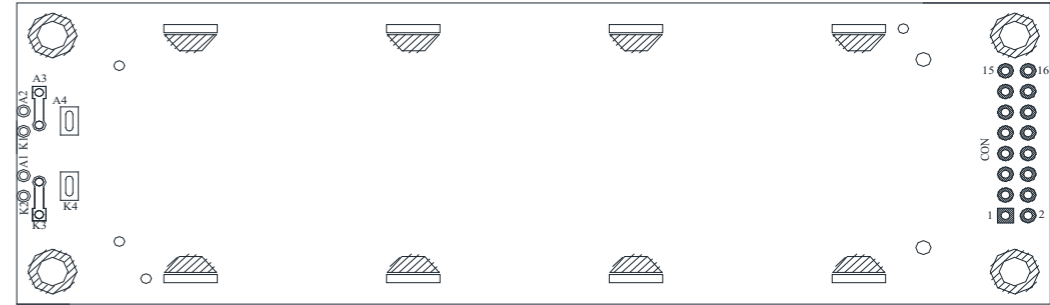
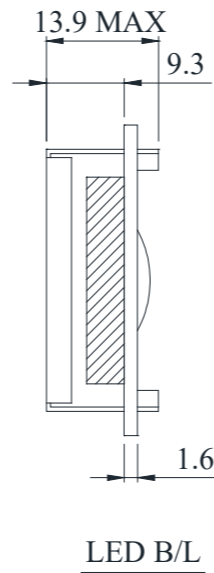
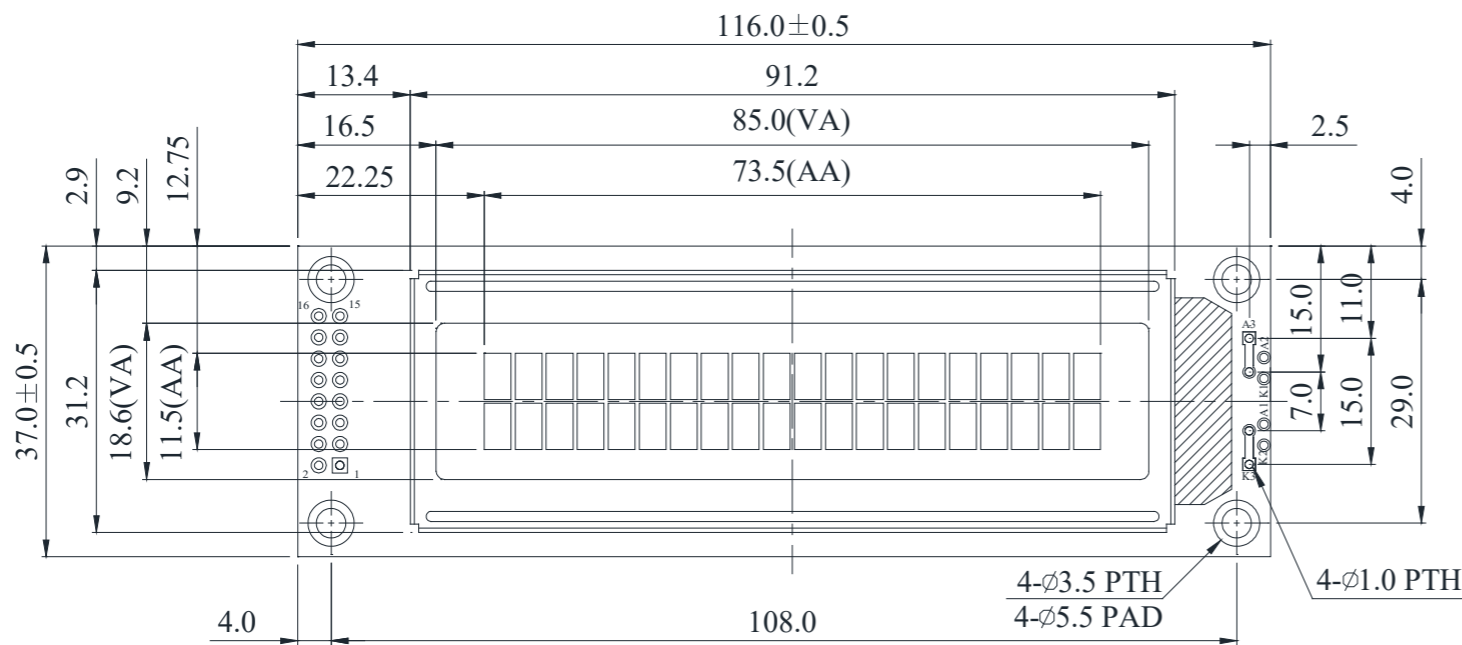

PIN NO.	SYMBOL
1	Vss
2	Vdd
3	Vo
4	RS
5	R/W
6	E
7	DB0
8	DB1
9	DB2
10	DB3
11	DB4
12	DB5
13	DB6
14	DB7
15	A
16	K

20.00
 12.00
 NEWHAVEN DISPLAY
 NHD-0220DZ-NSW-FBW_Rev1A
 www.newhavendisplay.com
 Datecode
 Made in China

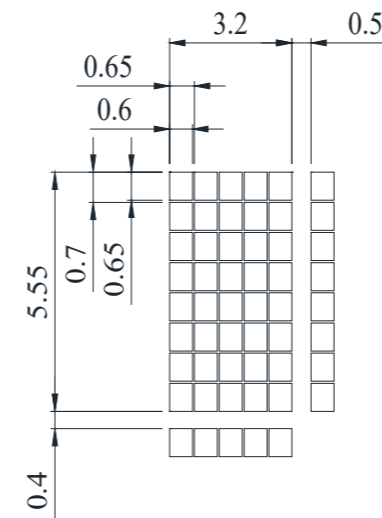

- Notes:
- 1. Driver: 1/16 Duty, 1/5 Bias
 - 2. Voltage: 5.0V VDD, 4.35V VLCD
 - 3. Display Mode: FSTN Negative / Transmissive
 - 4. Optimal View: 6:00
 - 5. Backlight: White LED
 - 6. Driver IC: ST7066U 8/4-Bit MPU Interface

STANDARD TOLERANCE: (UNLESS OTHERWISE SPECIFIED)		
LINEAR: ±0.3mm	DRAWING/PART NUMBER: NHD-0220DZ-NSW-FBW	
UNLESS OTHERWISE SPECIFIED: - DIMENSIONS ARE IN MILLIMETERS - THIRD ANGLE PROJECTION	DRAWN BY: A. Shah	APPROVED BY: A. Shah
	DRAWN DATE: 6/16/20	APPROVED DATE: 6/16/20
	DO NOT SCALE DRAWING	
	SHEET 1 OF 1	
THIS DRAWING IS SOLELY THE PROPERTY OF NEWHAVEN DISPLAY INTERNATIONAL, INC. THE INFORMATION IT CONTAINS IS NOT TO BE DISCLOSED, REPRODUCED OR COPIED IN WHOLE OR PART WITHOUT WRITTEN APPROVAL FROM NEWHAVEN DISPLAY.		

Pin Description and Wiring Diagram

Pin No.	Symbol	External Connection	Function Description
1	V _{SS}	Power Supply	Ground
2	V _{DD}	Power Supply	Supply Voltage for logic (+5.0V)
3	V ₀	Adj. Power Supply	Power supply for contrast (approx. 0.7V)
4	RS	MPU	Register Select signal. RS=0: Command, RS=1: Data
5	R/W	MPU	Read/Write select signal, R/W=1: Read R/W=0: Write
6	E	MPU	Operation Enable signal. Falling edge triggered.
7-10	DB0 – DB3	MPU	Four low order bi-directional three-state data bus lines. These four are not used during 4-bit operation.
11-14	DB4 – DB7	MPU	Four high order bi-directional three-state data bus lines.
15	LED_A	Power Supply	Backlight Anode (+5.0V via on-board resistor)
16	LED_K	Power Supply	Backlight Cathode (Ground)

Recommended LCD connector: 2x8 2.54mm pitch connector

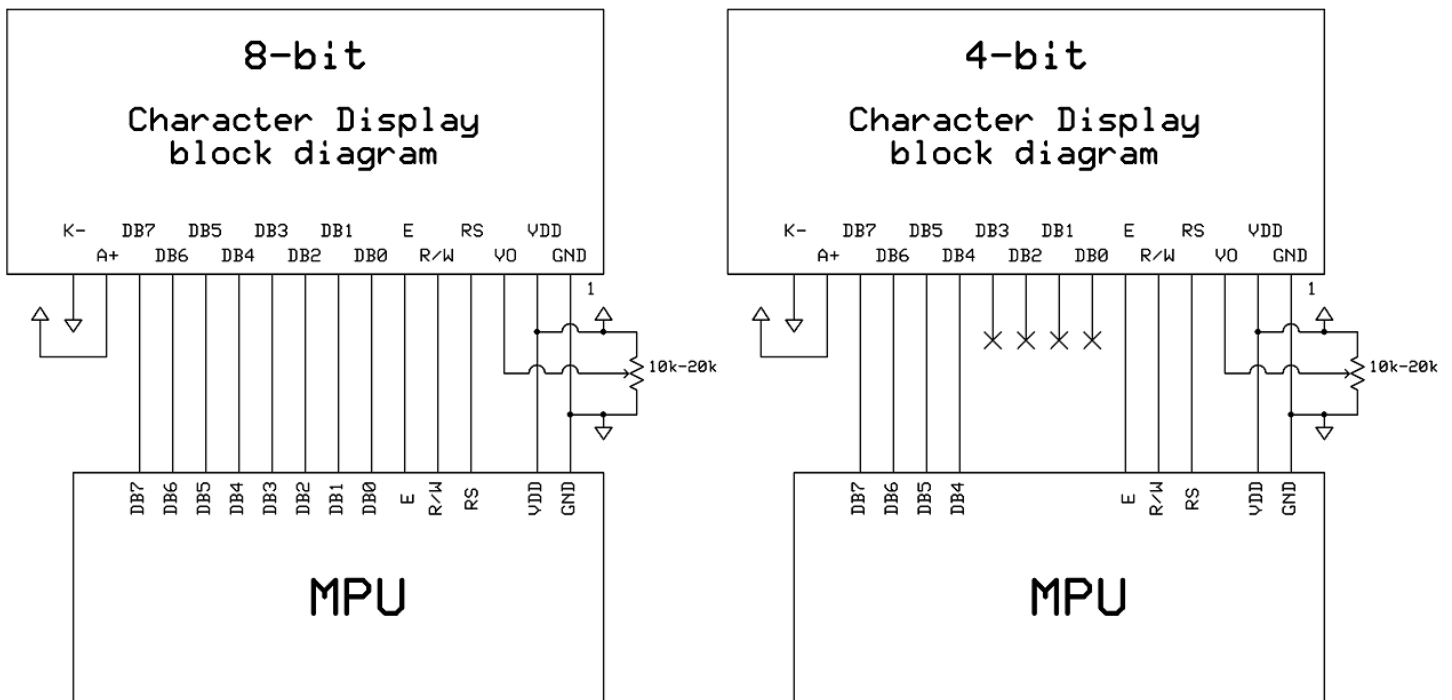

Electrical Characteristics

Item	Symbol	Condition	Min.	Typ.	Max.	Unit
Operating Temperature Range	T _{OP}	Absolute Max	-20	-	+70	°C
Storage Temperature Range	T _{ST}	Absolute Max	-30	-	+80	°C
Supply Voltage	V _{DD}	-	4.5	5.0	5.5	V
Supply Current	I _{DD}	V _{DD} = 5.0V	1.0	1.2	1.5	mA
Supply for LCD (contrast)	V _{LCD}	T _{OP} = 25°C	4.2	4.35	4.5	V
"H" Level input	V _{IH}	-	0.7 * V _{DD}	-	V _{DD}	V
"L" Level input	V _{IL}	-	V _{SS}	-	0.6	V
"H" Level output	V _{OH}	-	3.9	-	V _{DD}	V
"L" Level output	V _{OL}	-	V _{SS}	-	0.4	V
Backlight Supply Current	I _{LED}	V _{LED} = 5.0V	24	32	40	mA
Backlight Supply Voltage	V _{LED}	-	4.9	5.0	5.1	V

Optical Characteristics

Item	Symbol	Condition	Min.	Typ.	Max.	Unit
Optimal Viewing Angles	Top	CR ≥ 2	-	30	-	°
	Bottom		-	60	-	°
	Left		-	45	-	°
	Right		-	45	-	°
Contrast Ratio	CR	-	2	5	-	-
Response Time	Rise	T _{OP} = 25°C	-	150	200	ms
	Fall		-	150	200	ms

Controller Information

Built-in ST7066U controller.

Please download specification at http://www.newhavendisplay.com/app_notes/ST7066U.pdf

DDRAM Address

1	2	3	4	5	6	7	8	9	10	11	12	13	14	15	16	17	18	19	20
00	01	02	03	04	05	06	07	08	09	0A	0B	0C	0D	0E	0F	10	11	12	13
40	41	42	43	44	45	46	47	48	49	4A	4B	4C	4D	4E	4F	50	51	52	53

Table of Commands

Instruction	Instruction code										Description	Execution time (f _{osc} =270 KHZ)	
	RS	R/W	DB7	DB6	DB5	DB4	DB3	DB2	DB1	DB0			
Clear Display	0	0	0	0	0	0	0	0	0	0	1	Write "20H" to DDRAM and set DDRAM address to "00H" from AC	1.52ms
Return Home	0	0	0	0	0	0	0	0	0	1	-	Set DDRAM Address to "00H" from AC and return cursor to its original position if shifted. The contents of DDRAM are not changed.	1.52ms
Entry mode Set	0	0	0	0	0	0	0	0	1	I/D	SH	Sets cursor move direction and specifies display shift. These parameters are performed during data write and read.	37μs
Display ON/OFF control	0	0	0	0	0	0	0	1	D	C	B	D=1: Entire display on C=1: Cursor on B=1: Blinking cursor on	37μs
Cursor or Display shift	0	0	0	0	0	0	1	S/C	R/L	-	-	Sets cursor moving and display shift control bit, and the direction without changing DDRAM data.	37μs
Function set	0	0	0	0	1	DL	N	F	-	-	-	DL: Interface data is 8/4 bits N: Number of lines is 2/1 F: Font size is 5x11/5x8	37μs
Set CGRAM Address	0	0	0	1	AC5	AC4	AC3	AC2	AC1	AC0		Set CGRAM address in address counter	37μs
Set DDRAM Address	0	0	1	AC6	AC5	AC4	AC3	AC2	AC1	AC0		Set DDRAM address in address counter.	37μs
Read busy Flag and Address	0	1	BF	AC6	AC5	AC4	AC3	AC2	AC1	AC0		Whether during internal operation or not can be known by reading BF. The contents of address counter can also be read.	0s
Write data To Address	1	0	D7	D6	D5	D4	D3	D2	D1	D0		Write data into internal RAM (DDRAM/CGRAM).	37μs
Read data From RAM	1	1	D7	D6	D5	D4	D3	D2	D1	D0		Read data from internal RAM (DDRAM/CGRAM).	37μs

Timing Characteristics

Writing data from MPU to ST7066U

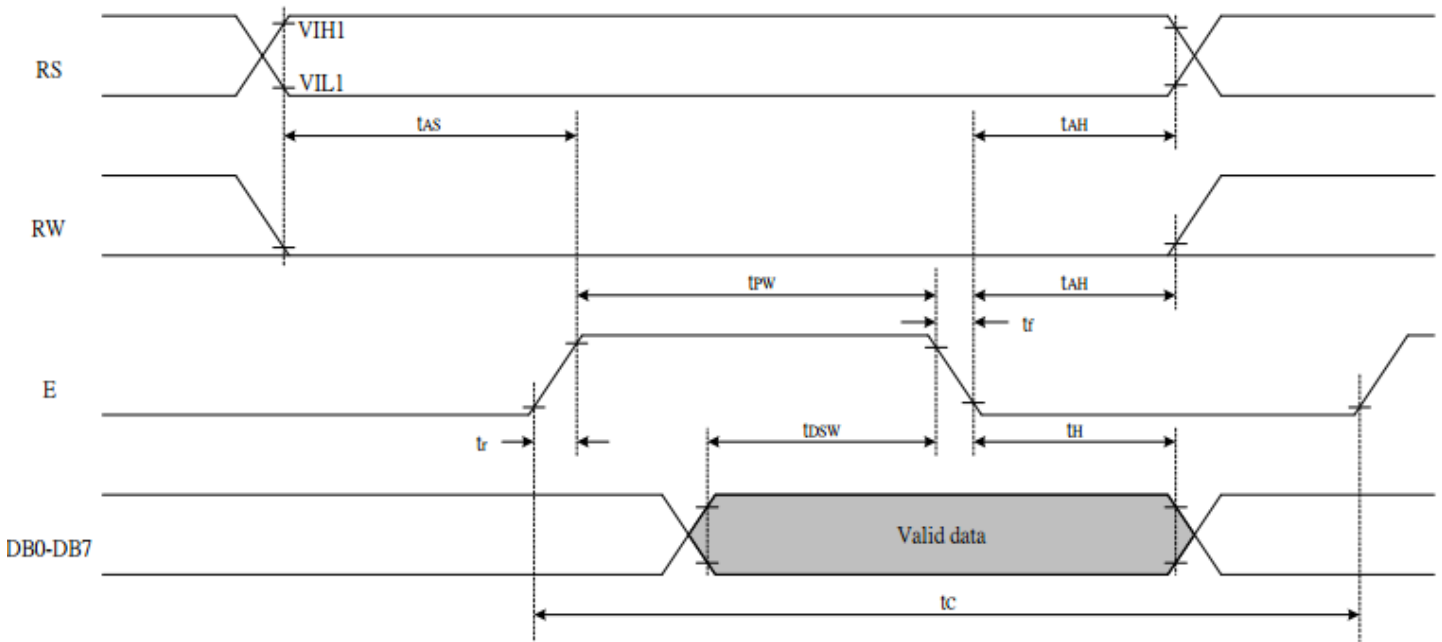

Write Mode (Writing data from MPU to ST7066U)						
T_C	Enable Cycle Time	Pin E	1200	-	-	ns
T_{PW}	Enable Pulse Width	Pin E	140	-	-	ns
T_R, T_F	Enable Rise/Fall Time	Pin E	-	-	25	ns
T_{AS}	Address Setup Time	Pins: RS,RW,E	0	-	-	ns
T_{AH}	Address Hold Time	Pins: RS,RW,E	10	-	-	ns
T_{DSW}	Data Setup Time	Pins: DB0 - DB7	40	-	-	ns
T_H	Data Hold Time	Pins: DB0 - DB7	10	-	-	ns

Reading data from ST7066U to MPU



Read Mode (Reading Data from ST7066U to MPU)						
T_C	Enable Cycle Time	Pin E	1200	-	-	ns
T_{PW}	Enable Pulse Width	Pin E	140	-	-	ns
T_{R,T_F}	Enable Rise/Fall Time	Pin E	-	-	25	ns
T_{AS}	Address Setup Time	Pins: RS,RW,E	0	-	-	ns
T_{AH}	Address Hold Time	Pins: RS,RW,E	10	-	-	ns
T_{DDR}	Data Setup Time	Pins: DB0 - DB7	-	-	100	ns
T_H	Data Hold Time	Pins: DB0 - DB7	10	-	-	ns

Built-in Font Table

b7-b4 b3-b0	0000	0001	0010	0011	0100	0101	0110	0111	1000	1001	1010	1011	1100	1101	1110	1111
0000	CG RAM (1)			0	a	P	^	P				—	9	3	o	p
0001	(2)	!	1	A	Q	a	A				a	7	7	6	ä	g
0010	(3)	"	2	B	R	b	r				"	4	9	×	P	o
0011	(4)	#	3	C	S	c	s				!	9	7	e	e	×
0100	(5)	\$	4	D	T	d	t				√	I	1	h	H	o
0101	(6)	%	5	E	U	e	u				*	7	6	1	o	o
0110	(7)	&	6	F	V	f	v				9	h	2	3	P	2
0111	(8)	'	7	G	W	g	w				7	7	7	9	g	π
1000	(1)	(8	H	X	h	x				4	9	*	9	7	2
1001	(2))	9	I	Y	i	y				o	7	7	6	7	y
1010	(3)	*	:	J	Z	j	z				e	o	n	√	j	7
1011	(4)	+	;	K	[k	[*	9	e	o	*	7
1100	(5)	,	<	L	¥	l	l				e	o	7	7	o	7
1101	(6)	—	=	M]	m]				u	2	^	7	7	÷
1110	(7)	.	>	N	^	n	^				e	e	e	^	7	
1111	(8)	/	?	O	_	o	_				9	9	7	"	o	■

Example Initialization Program

8-bit Initialization:

```

/*****/
void command(char i)
{
    P1      = i;           //put data on output Port
    D_I     = 0;           //D/I=LOW : send instruction
    R_W     = 0;           //R/W=LOW : Write
    E       = 1;
    Delay(1);              //enable pulse width >= 300ns
    E       = 0;           //Clock enable: falling edge
}
/*****/
void write(char i)
{
    P1      = i;           //put data on output Port
    D_I     = 1;           //D/I=HIGH : send data
    R_W     = 0;           //R/W=LOW : Write
    E       = 1;
    Delay(1);              //enable pulse width >= 300ns
    E       = 0;           //Clock enable: falling edge
}
/*****/
void init()
{
    E       = 0;
    Delay(100);            //Wait >40 msec after power is applied
    command(0x30);         //command 0x30 = Wake up
    Delay(30);             //must wait 5ms, busy flag not available
    command(0x30);         //command 0x30 = Wake up #2
    Delay(10);             //must wait 160us, busy flag not available
    command(0x30);         //command 0x30 = Wake up #3
    Delay(10);             //must wait 160us, busy flag not available
    command(0x38);         //Function set: 8-bit/2-line
    command(0x10);         //Set cursor
    command(0x0c);         //Display ON; Cursor ON
    command(0x06);         //Entry mode set
}
/*****/
```

```

4-bit Initialization:
/*****/
void command(char i)
{
    P1    = i;           //put data on output Port
    D_I   = 0;          //D/I=LOW : send instruction
    R_W   = 0;          //R/W=LOW : Write
    Nybble();           //Send upper 4 bits
    i     = I << 4;     //Shift over by 4 bits
    P1    = i;           //put data on output Port
    Nybble();           //Send upper 4 bits
}
/*****/
void write(char i)
{
    P1    = i;           //put data on output Port
    D_I   = 1;          //D/I=HIGH : send data
    R_W   = 0;          //R/W=LOW : Write
    Nybble();           //Clock upper 4 bits
    i     = I << 4;     //Shift over by 4 bits
    P1    = i;           //put data on output Port
    Nybble();           //Clock upper 4 bits
}
/*****/
void Nybble()
{
    E     = 1;
    Delay(1);           //enable pulse width >= 300ns
    E     = 0;           //Clock enable: falling edge
}
/*****/
void init()
{
    P1    = 0;
    P3    = 0;
    Delay(100);         //Wait >40 msec after power is applied
    P1 = 0x30;           //put 0x30 on the output port
    Delay(30);          //must wait 5ms, busy flag not available
    Nybble();           //command 0x30 = Wake up
    Delay(10);          //must wait 160us, busy flag not available
    Nybble();           //command 0x30 = Wake up #2
    Delay(10);          //must wait 160us, busy flag not available
    Nybble();           //command 0x30 = Wake up #3
    Delay(10);          //can check busy flag now instead of delay
    P1    = 0x20;        //put 0x20 on the output port
    Nybble();           //Function set: 4-bit interface
    command(0x28);      //Function set: 4-bit/2-line
    command(0x10);      //Set cursor
    command(0x0F);      //Display ON; Blinking cursor
    command(0x06);      //Entry Mode set
}
/*****/

```

Quality Information

Test Item	Content of Test	Test Condition	Note
High Temperature storage	Endurance test applying the high storage temperature for a long time.	+80°C , 96hrs	2
Low Temperature storage	Endurance test applying the low storage temperature for a long time.	-30°C , 96hrs	1,2
High Temperature Operation	Endurance test applying the electric stress (voltage & current) and the high thermal stress for a long time.	+70°C , 96hrs	2
Low Temperature Operation	Endurance test applying the electric stress (voltage & current) and the low thermal stress for a long time.	-20°C , 96hrs	1,2
High Temperature / Humidity Operation	Endurance test applying the electric stress (voltage & current) and the high thermal with high humidity stress for a long time.	+40°C , 90% RH , 96hrs	1,2
Thermal Shock resistance	Endurance test applying the electric stress (voltage & current) during a cycle of low and high thermal stress.	-20°C,30min -> 25°C,5min -> 70°C,30min = 1 cycle 10 cycles	
Vibration test	Endurance test applying vibration to simulate transportation and use.	10-55Hz , 1.5mm amplitude. 60 sec in each of 3 directions X,Y,Z For 15 minutes	3
Static electricity test	Endurance test applying electric static discharge.	Air: ±800V, RS=330Ω, CS=150pF Contact: ±600V, RS=330Ω, CS=150pF For 10 Times	

Note 1: No condensation to be observed.

Note 2: Conducted after 4 hours of storage at 25°C, 0%RH.

Note 3: Test performed on product itself, not inside a container.

Precautions for using LCDs/LCMs

See Precautions at www.newhavendisplay.com/specs/precautions.pdf

Warranty Information and Terms & Conditions

http://www.newhavendisplay.com/index.php?main_page=terms