

STELLA-VSM

IESNA Type V (square) beam for wide areas such as car parks. Compatible with up to 30 mm LES size COBs. Variant with white frame.

SPECIFICATION:

Dimensions	Ø 90.0 mm
Height	20.7 mm
Fastening	socket
Ingress protection classes	IP67
ROHS compliant	yes ⓘ

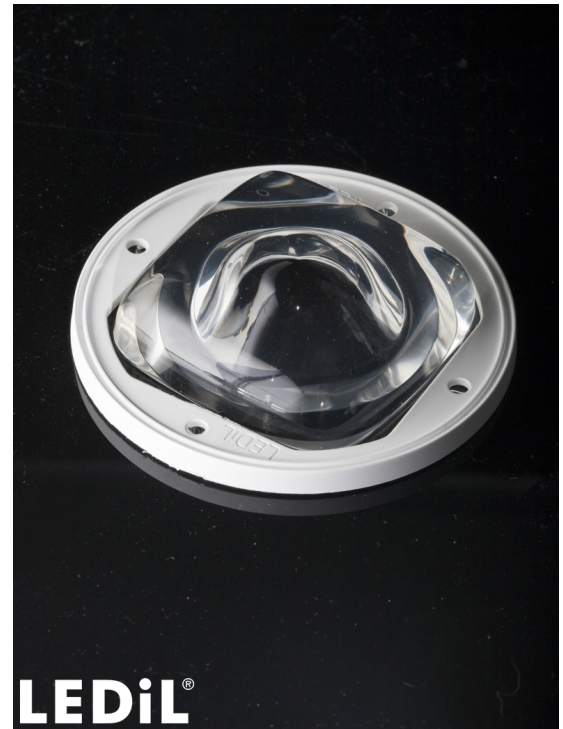

MATERIALS:

Component	Type	Material	Colour	Finish
STELLA-VSM	Single lens	Silicone	clear	
STELLA-FRAME-WHT	Holder	PA66	white	

ORDERING INFORMATION:

Component		Qty in box	MOQ	MPQ	Box weight (kg)
FN16477_STELLA-VSM	Single lens	135	135	15	9.2
» Box size: 480 x 280 x 300 mm					

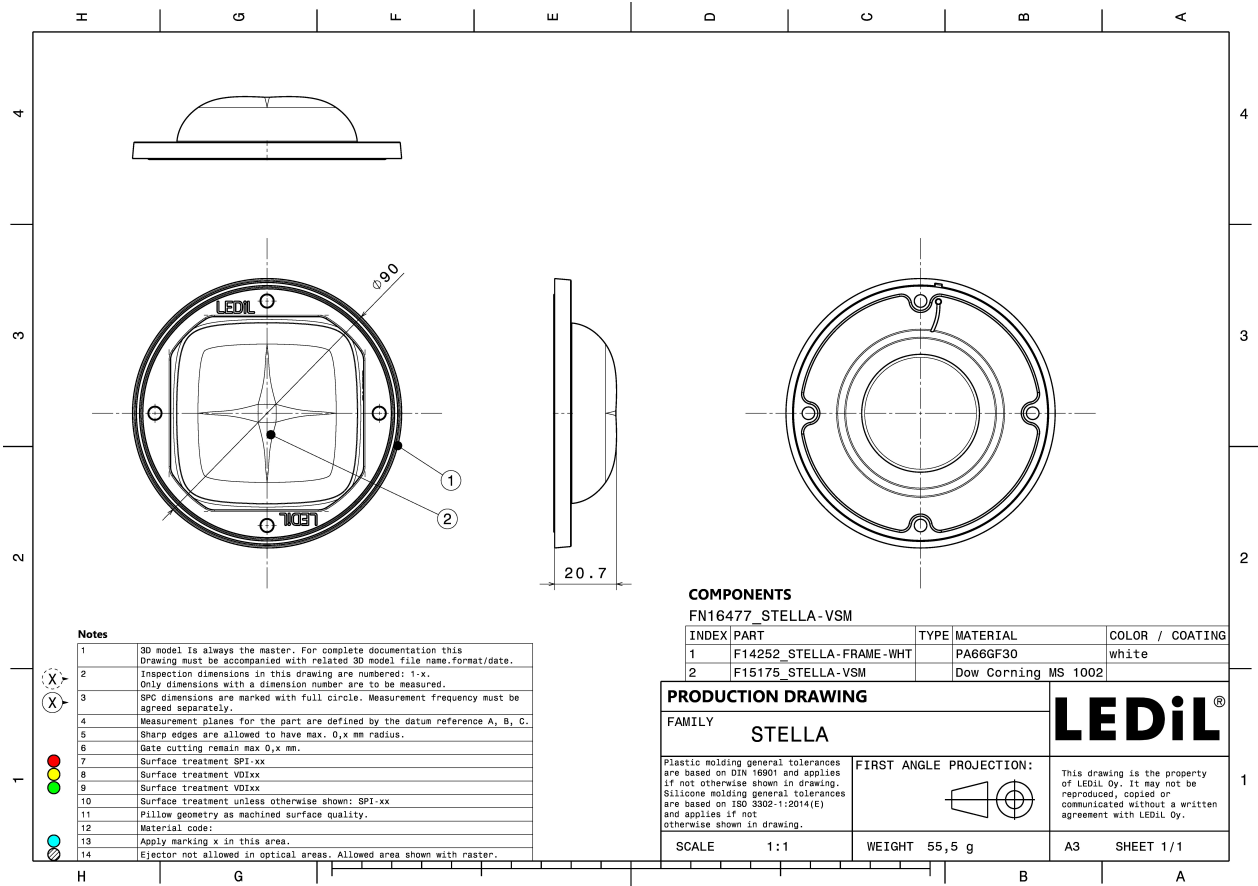

See also our general installation guide: www.ledil.com/installation_guide

OPTICAL RESULTS (MEASURED):

bridgelux.

LED V18 Gen7
 FWHM / FWTM Asymmetric
 Efficiency 94 %
 Peak intensity 0.4 cd/lm
 LEDs/each optic 1
 Light colour White
 Required components:

bridgelux.

LED V22 Gen7
 FWHM / FWTM Asymmetric
 Efficiency 94 %
 Peak intensity 0.3 cd/lm
 LEDs/each optic 1
 Light colour White
 Required components:

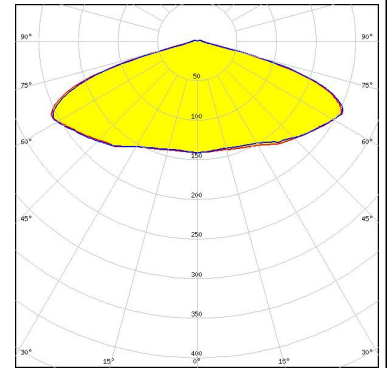

bridgelux.

LED V22 Gen7
 FWHM / FWTM Asymmetric
 Efficiency 94 %
 Peak intensity 0.3 cd/lm
 LEDs/each optic 1
 Light colour White
 Required components:
 Bender Wirth: 431 Typ Z1

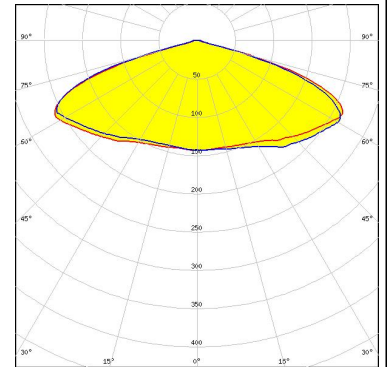

bridgelux.

LED Vero SE 13
 FWHM / FWTM Asymmetric
 Efficiency 90 %
 Peak intensity 0.6 cd/lm
 LEDs/each optic 1
 Light colour White
 Required components:

OPTICAL RESULTS (MEASURED):

bridgelux.

LED Vero SE 18
FWHM / FWTM Asymmetric
Efficiency 94 %
Peak intensity 0.4 cd/lm
LEDs/each optic 1
Light colour White
Required components:

bridgelux.

LED Vero SE 29
FWHM / FWTM Asymmetric
Efficiency 94 %
Peak intensity 0.3 cd/lm
LEDs/each optic 1
Light colour White
Required components:



bridgelux.

LED VERO18
FWHM / FWTM Asymmetric
Efficiency 94 %
Peak intensity 0.4 cd/lm
LEDs/each optic 1
Light colour White
Required components:

CITIZEN

LED CLL05x/CLU05x
FWHM / FWTM Asymmetric
Efficiency 94 %
Peak intensity 0.3 cd/lm
LEDs/each optic 1
Light colour White
Required components:

OPTICAL RESULTS (MEASURED):

 SEOL SEMICONDUCTOR	
LED	MJT COB LES 14.5
FWHM / FWTM	Asymmetric
Efficiency	94 %
Peak intensity	0.5 cd/lm
LEDs/each optic	1
Light colour	White
Required components:	
 SEOL SEMICONDUCTOR	
LED	MJT COB LES 22
FWHM / FWTM	Asymmetric
Efficiency	94 %
Peak intensity	0.3 cd/lm
LEDs/each optic	1
Light colour	White
Required components:	
 SEOL SEMICONDUCTOR	
LED	MJT COB LES 33
FWHM / FWTM	Asymmetric
Efficiency	94 %
Peak intensity	0.2 cd/lm
LEDs/each optic	1
Light colour	White
Required components:	

OPTICAL RESULTS (SIMULATED):

bridgelux.

LED	V10 Gen7
FWHM / FWTM	Asymmetric
Efficiency	93 %
Peak intensity	0.5 cd/lm
LEDs/each optic	1
Light colour	White

Required components:

bridgelux.

LED	V13 Gen7
FWHM / FWTM	Asymmetric
Efficiency	97 %
Peak intensity	0.4 cd/lm
LEDs/each optic	1
Light colour	White

Required components:

bridgelux.

LED	V13 Gen7
FWHM / FWTM	Asymmetric
Efficiency	98 %
Peak intensity	0.4 cd/lm
LEDs/each optic	1
Light colour	White

Required components:

CITIZEN

LED	CLL04x/CLU04x
FWHM / FWTM	Asymmetric
Efficiency	93 %
Peak intensity	0.3 cd/lm
LEDs/each optic	1
Light colour	White

Required components:

OPTICAL RESULTS (SIMULATED):

CITIZEN

LED	CLL04x/CLU04x
FWHM / FWTM	Asymmetric
Efficiency	94 %
Peak intensity	0.3 cd/lm
LEDs/each optic	1
Light colour	White
Required components:	



LED	CXA/B 25xx
FWHM / FWTM	Asymmetric
Efficiency	94 %
Peak intensity	0.4 cd/lm
LEDs/each optic	1
Light colour	White
Required components:	



LED	CXA/B 30xx
FWHM / FWTM	Asymmetric
Efficiency	94 %
Peak intensity	0.3 cd/lm
LEDs/each optic	1
Light colour	White
Required components:	



LED	LUXEON CoB 1208
FWHM / FWTM	Asymmetric
Efficiency	96 %
Peak intensity	0.5 cd/lm
LEDs/each optic	1
Light colour	White
Required components:	

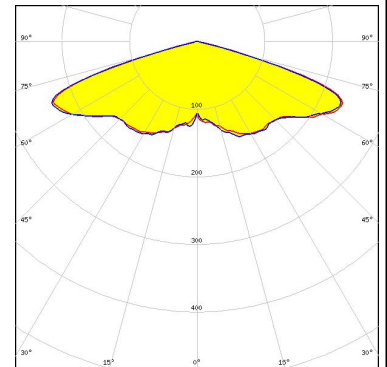

OPTICAL RESULTS (SIMULATED):

LUMILEDS

LED	LUXEON CoB 1216/1812
FWHM / FWTM	Asymmetric
Efficiency	92 %
Peak intensity	0.3 cd/lm
LEDs/each optic	1
Light colour	White
Required components:	

LUMINUS

LED	CxM-22 (28x28)
FWHM / FWTM	Asymmetric
Efficiency	94 %
Peak intensity	0.3 cd/lm
LEDs/each optic	1
Light colour	White
Required components:	

GENERAL INFORMATION:

NOTE: The typical beam angle will be changed by different color, chip size and chip position tolerance. The typical total beam angle is the full angle measured where the luminous intensity is half of the peak value.

Due to use of high power COB's with this product, special attention to proper thermal design is highly recommended. LEDiL has no liability for direct, indirect or consecutive damages arising from the LEDiL products being used outside of the recommended temperature range.

MATERIALS:

As part of our continuous research and improvement processes, and to ensure the best possible quality and availability of our products, LEDiL reserves the right to change material grades without notice.

PRODUCT DATA USER AGREEMENT AND DISCLAIMER:

The measured data in the provided downloadable LEDiL Product Datasheets and Mechanical 2D-Drawings is rounded and provided as reference for planning. LEDiL Oy's optical specifications have been verified by conducting performance testing of the products in accordance with the company's quality system. The reported data are averaged results of multiple measurements with typical variation. LEDiL Oy reserves the right to without prior notification make changes and improvements to its products.

LEDiL Oy assumes neither warranty, nor guarantee nor any other liability of any kind for the contents and correctness of the provided data. The provided data has been generated with highest diligence but the provided data may in reality not represent the complete possible variation range of all intrinsic parameters. Therefore, in certain cases a deviation from the provided data could occur.

LEDiL Oy reserves the right to undertake technical changes of its products without further notification which could lead to changes in the provided data. LEDiL Oy assumes no liability of any kind for the possible deviation from any provided data or any other damage resulting from the usage of the provided data.

The user agrees to this disclaimer and user agreement with the download or usage of the provided files.

LEDiL Oy

Joensuunkatu 13
FI-24240 SALO
Finland

LEDiL Inc.

228 West Page Street
Suite D
Sycamore IL 60178
USA

Ledil Optics Technology (Shenzhen) Co., Ltd.

405 , Block B
Casic Motor Building
Shenzhen 518057
P.R.CHINA

Local sales and technical support

[www.ledil.com/
where_to_buy](http://www.ledil.com/where_to_buy)

Shipping locations

Salo, Finland
Hong Kong, China

Distribution Partners

[www.ledil.com/
where_to_buy](http://www.ledil.com/where_to_buy)