

RF Microwave Products

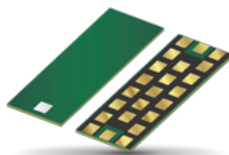
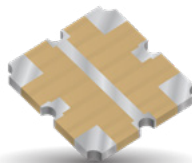
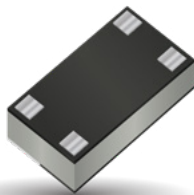

IMPORTANT INFORMATION/DISCLAIMER

All product specifications, statements, information and data (collectively, the “Information”) in this datasheet or made available on the website are subject to change. The customer is responsible for checking and verifying the extent to which the Information contained in this publication is applicable to an order at the time the order is placed. All Information given herein is believed to be accurate and reliable, but it is presented without guarantee, warranty, or responsibility of any kind, expressed or implied.

Statements of suitability for certain applications are based on KYOCERA AVX knowledge of typical operating conditions for such applications, but are not intended to constitute and KYOCERA AVX specifically disclaims any warranty concerning suitability for a specific customer application or use.

ANY USE OF PRODUCT OUTSIDE OF SPECIFICATIONS OR ANY STORAGE OR INSTALLATION INCONSISTENT WITH PRODUCT GUIDANCE VOIDS ANY WARRANTY.

The Information is intended for use only by customers who have the requisite experience and capability to determine the correct products for their application. Any technical advice inferred from this Information or otherwise provided by KYOCERA AVX with reference to the use of KYOCERA AVX products is given without regard, and KYOCERA AVX assumes no obligation or liability for the advice given or results obtained.

Although KYOCERA AVX designs and manufactures its products to the most stringent quality and safety standards, given the current state of the art, isolated component failures may still occur. Accordingly, customer applications which require a high degree of reliability or safety should employ suitable designs or other safeguards (such as installation of protective circuitry or redundancies) in order to ensure that the failure of an electrical component does not result in a risk of personal injury or property damage.

Unless specifically agreed to in writing, KYOCERA AVX has not tested or certified its products, services or deliverables for use in high risk applications including medical life support, medical device, direct physical patient contact, water treatment, nuclear facilities, weapon systems, mass and air transportation control, flammable environments, or any other potentially life critical uses. Customer understands and agrees that KYOCERA AVX makes no assurances that the products, services or deliverables are suitable for any high-risk uses. Under no circumstances does KYOCERA AVX warrant or guarantee suitability for any customer design or manufacturing process.

Although all product-related warnings, cautions and notes must be observed, the customer should not assume that all safety measures are indicated or that other measures may not be required.

Thin-Film RF/Microwave Capacitor Technology

Accu-P® Series

Thin-Film Technology.....	2
Thin-Film Chip Capacitors	4
Single and Power Type Capacitors	5
0201 Typical Electrical Tables.....	6
0402 Typical Electrical Tables.....	8
0603 Typical Electrical Tables.....	10
0805 Typical Electrical Tables.....	12
1210 Typical Electrical Tables.....	14
High Frequency Characteristics	16
Environmental / Mechanical Characteristics	22
Performance Characteristics RF Power Applications.....	23
Application Notes.....	24
Ultra-Miniature 01005 Size	27

Thin-Film RF/Microwave Inductor Technology

Accu-L® Series

L0201 Tight Tolerance RF Inductor	30
L0402 Tight Tolerance RF Inductor	32
AEC-Q200 High-Q RF Inductor - L0402 & L0805.....	34
L0603 AND L0805 SMD High-Q RF Inductor – Accu-L®.....	38
Environmental Characteristics	42
Application Notes.....	43

Thin-Film RF/Microwave Products

Designer Kits.....	45
--------------------	----

Thin-Film RF/Microwave Directional Couplers

CP0302/CP0402/CP0603/CP0805 and DB0603N/DB0805 3dB 90°

CP0402W2700FNTR Wide Band High Directivity.....	49
High Directivity Directional Couplers For WiFi Bands	55
CP0402P High Directivity, Tight Coupling Tolerance	57
CP0402 High Directivity LGA Termination.....	59
CP0603 High Directivity LGA Type.....	63
CP0402 / CP0603 High Directivity Couplers Test Jigs.....	69
LGA Couplers Design Kits.....	71
CP0603 SMD Type	72
CP0603 SMD Type – High Directivity.....	75
CP0805 SMD Type	76
CP0805 Layout Types	77
CP0805 and CP0603 Test Jig	81
DB0603N 3dB 90° Couplers.....	82
DB0805 3dB 90° Couplers	99

Thin-Film RF/Microwave Filters

Low Pass – Harmonic Lead-Free

LP0402N Series – LGA Termination.....	116
LP0402N Series – Test Jig.....	119
LP0603 Series – LGA Termination.....	120
LP0603 Series – Test Jig.....	124
LP0805 Series – SMD Termination.....	125
LP0805 Series – Test Jig.....	127

Low Pass 0805 High Performance SMD 8W.....

1206 Harmonic Low Pass Filter

1206 High Performance Low Pass 12W.....	184
---	-----

1206 High Performance Low Pass 8W.....	203
--	-----

2816 High Performance Low Pass 20W	218
--	-----

BP0805 Band Pass Filter SMD 5W.....	234
-------------------------------------	-----

BP1206 Band Pass Filter SMD 8W.....	248
-------------------------------------	-----

Multilayer Organic (MLO®) Filters

MLO® High Pass Filters

General Information	257
Electrical Specifications.....	258

MLO® Low Pass Filters

General Information	277
Electrical Specifications.....	278

MLO® Band Pass Filters

General Information	319
Electrical Specifications.....	319

MLO® X Band Filters

General Information	356
---------------------------	-----

Mechanical Specifications, Pad Layout, and Mounting Recommendations

Footprint A	366
Footprint B	369
Footprint C	372
Footprint D	375
Footprint E	378
Footprint E1	381
Footprint E2	384
Footprint F.....	387

Multilayer Organic (MLO®) Capacitors

General Information	391
Mechanical & Environmental Specifications	392

Multilayer Organic (MLO®) Diplexers

0603 WLAN/BT.....	395
0805 CDMA.....	398
0805 WCDMA	400
0805 WLAN.....	402
0805 WLAN/BT.....	404
Automated SMT Assembly/SMT Reflow Profile	406

Multilayer Organic (MLO®) Inductors

Tight Tolerance.....	407
High Current.....	409
Hi-Q.....	411
Performance Characteristics.....	413
Automated SMT Assembly/SMT Reflow Profile	414

Multilayer Organic (MLO®) SMT Crossovers

RF-DC	415
RF-RF.....	418
Automated SMT Assembly/SMT Reflow Profile	421

RF/Microwave Inductors

AL Series – Air Core Inductors.....	422
-------------------------------------	-----

AS Series – Square Air Core Inductors	429
---	-----

LCWC Series – Wire Wound Chip Inductor.....	435
---	-----

RF/Microwave Products

Table of Contents

LCCI Series – Multi-Layer Ceramic Chip Inductors.....436

RF/Microwave Capacitors

RF/Microwave Multilayer Capacitors (MLC)

100A Series Porcelain Superchip® Multilayer Capacitors.....**437**
 100B Series Porcelain Superchip® Multilayer Capacitors.....**443**
 100C Series Porcelain Superchip® Multilayer Capacitors.....**450**
 100E Series Porcelain High RF Power Multilayer Capacitors.....**455**
 180R Series NPO Porcelain Ultra-Low ESR**461**
 200A Series BX Ceramic**466**
 200B Series BX Ceramic**470**
 530L Series Broadband Multilayer Capacitors**475**
 550-560 Series UBC™ Ultra-Broadband Capacitor**477**
 600L Ultra-Low ESR NPO Capacitors**484**
 600F Ultra-Low ESR, High Q, NPO Capacitors**488**
 600S Ultra-Low ESR, High Q, NPO Capacitors**492**
 700A Series NPO Porcelain and Ceramic Multilayer Capacitors.....**497**
 700B Series NPO Porcelain and Ceramic Multilayer Capacitors**503**
 700C Series NPO Porcelain and Ceramic Multilayer Capacitors**511**
 700E Series NPO Porcelain High RF Power Multilayer Capacitors**516**
 800A Series NPO Porcelain, High RF Power Ultra-Low ESR**522**
 800B Series NPO Porcelain, High RF Power Ultra-Low ESR**528**
 800C Series NPO Porcelain, High RF Power Ultra-Low ESR**533**
 800E Series NPO Ceramic High RF Power Multilayer Capacitors.....**537**
 800H Series NPO Ceramic High RF Power Multilayer Capacitors**543**
 800R Series NPO Ceramic Ultra-Low ESR Multilayer Capacitors.....**547**
 900C Series X7R Ceramic RF Power Multilayer Capacitors**551**
 920C Series X7R Ceramic RF Power Multilayer Capacitors**556**
 CDR Series – MIL-PRF-55681/4/5 (RF/Microwave Chips)**558**
 Performance Curves**561**
 Automatic Insertion Packaging**566**

RF/Microwave C0G (NP0) Capacitors

Ultra Low ESR “CU” Series, C0G (NP0) Capacitors (RoHS)**567**
 Ultra Low ESR “U” Series, C0G (NP0) Capacitors (RoHS).....**569**
 Ultra Low ESR “U” Series, C0G (NP0) Capacitors (Sn/Pb).....**572**
 Ultra Low ESR “U” Series, C0G (NP0) Capacitors (RoHS)
 Automotive, AEC Q200 Qualified**575**

RF/Microwave “U” Series Designer Kits.....577



Thin-Film RF/Microwave Capacitor Technology

Accu-P[®] Series

THE IDEAL CAPACITOR

The non-ideal characteristics of a real capacitor can be ignored at low frequencies. Physical size imparts inductance to the capacitor and dielectric and metal electrodes result in resistive losses, but these often are of negligible effect on the circuit. At the very high frequencies of radio communication (>100MHz) and satellite systems (>1GHz), these effects become important. Recognizing that a real capacitor will exhibit inductive and resistive impedances in addition to capacitance, the ideal capacitor for these high frequencies is an ultra low loss component which can be fully characterized in all parameters with total repeatability from unit to unit.

Until recently, most high frequency/microwave capacitors were based on fired-ceramic (porcelain) technology. Layers of ceramic dielectric material and metal alloy electrode paste are interleaved and then sintered in a high temperature oven. This technology exhibits component variability in dielectric quality (losses, dielectric constant and insulation resistance), variability in electrode conductivity and variability in physical size (affecting inductance). An alternate thin-film technology has been developed which virtually eliminates these variances. It is this technology which has been fully incorporated into Accu-P® and Accu-P® to provide high frequency capacitors exhibiting truly ideal characteristics.

The main features of Accu-P® may be summarized as follows:

- High purity of electrodes for very low and repeatable ESR.
- Highly pure, low-K dielectric for high breakdown field, high insulation resistance and low losses to frequencies above 40GHz.
- Very tight dimensional control for uniform inductance, unit to unit.
- Very tight capacitance tolerances for high frequency signal applications.

This accuracy sets apart these Thin-Film capacitors from ceramic capacitors so that the term Accu has been employed as the designation for this series of devices, an abbreviation for “accurate.”



THIN-FILM TECHNOLOGY

Thin-film technology is commonly used in producing semiconductor devices. In the last two decades, this technology has developed tremendously, both in performance and in process control. Today's techniques enable line definitions of below 1µm, and the controlling of thickness of layers at 100Å (10-2µm). Applying this technology to the manufacture of capacitors has enabled the development of components where both electrical and physical properties can be tightly controlled.

The thin-film production facilities at KYOCERA AVX consist of:

- Class 1000 clean rooms, with working areas under laminar-flow hoods of class 100, (below 100 particles per cubic foot larger than 0.5µm).
- High vacuum metal deposition systems for high-purity electrode construction.
- Photolithography equipment for line definition down to 2.0µm accuracy.
- Plasma-enhanced CVD for various dielectric depositions (CVD=Chemical Vapor Deposition).
- High accuracy, microprocessor-controlled dicing saws for chip separation.
- High speed, high accuracy sorting to ensure strict tolerance adherence.

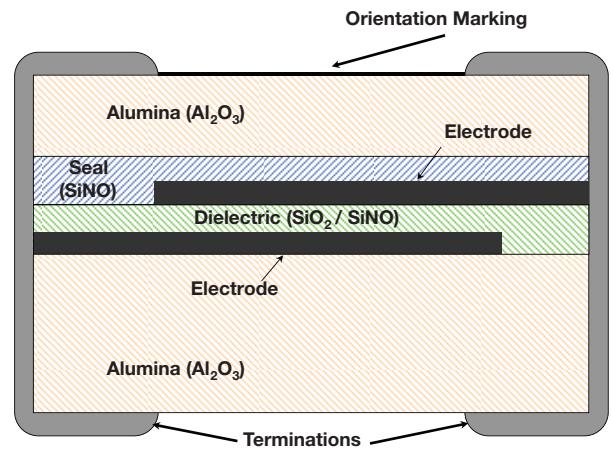

ACCU-P® CAPACITOR STRUCTURE

ACCU-P® TECHNOLOGY

The use of very low-loss dielectric materials, silicon dioxide and silicon oxynitride, in conjunction with highly conductive electrode metals results in low ESR and high Q. These high-frequency characteristics change at a slower rate with increasing frequency than for ceramic microwave capacitors.

Because of the thin-film technology, the above-mentioned frequency characteristics are obtained without significant compromise of properties required for surface mounting.

The main Accu-P® properties are:

- Internationally agreed sizes with excellent dimensional control.
- Ultra small size chip capacitors (1005) are available.
- Ultra tight capacitance tolerances.
- Low ESR at VHF, UHF and microwave frequencies.
- Enhanced RF power handling capability.
- High stability with respect to time, temperature, frequency and voltage variation.
- Nickel/solder-coated terminations to provide excellent solderability and leach resistance.

ACCU-P® FEATURES

Accu-P® meets the fast-growing demand for low-loss (high-Q) capacitors for use in surface mount technology especially for the mobile communications market, such as cellular radio of 450 and 900 MHz, UHF walkie-talkies, UHF cordless telephones to 2.3 GHz, low noise blocks at 11-12.5 GHz and for other VHF, UHF and microwave applications.

Accu-P® is currently unique in its ability to offer very low capacitance values (0.05pF) and very tight capacitance tolerances (± 0.01 pF).

- The RF power handling capability of the Accu-P® allows for its usage in both small signal and RF power applications.
- Thin Film Technology guarantees minimal batch to batch variability of parameters at high frequency.
- Inspection test and quality control procedures in accordance with ISO 9001, CECC, IECQ and USA MIL Standards yield products of the highest quality.
- Hand soldering Accu-P®: Due to their construction utilizing relatively high thermal conductivity materials, Accu-P's have become the preferred device in R & D labs and production environments where hand soldering is used.

APPLICATIONS

- Cellular Communications
- CT2/PCN (Cordless Telephone/Personal Comm. Networks)
- Satellite TV
- Cable TV
- GPS (Global Positioning Systems)
- Vehicle Location Systems
- Vehicle Alarm Systems
- Paging
- Military Communications
- Radar Systems
- Video Switching
- Test & Measurements
- Filters
- VCO's
- Matching Networks
- RF Amplifiers

APPROVALS

- ISO 9001
- IATF 16949:2016

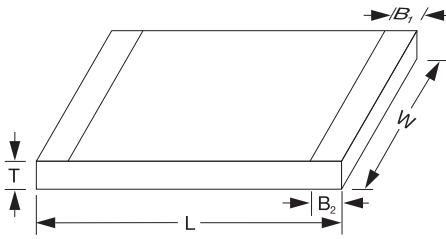

ACCU-P® (SIGNAL AND POWER TYPE CAPACITORS)

	01005*	0201*	0402*	0603*	0805*	1210
L	0.405±0.020 (0.016±0.001)	0.60±0.05 (0.023±0.002)	1.00±0.1 (0.039±0.004)	1.60±0.1 (0.063±0.004)	2.01±0.1 (0.079±0.004)	3.02±0.1 (0.119±0.004)
W	0.215±0.020 (0.0085±0.002)	0.325±0.050 (0.0128±0.002)	0.55±0.07 (0.022±0.003)	0.81±0.1 (0.032±0.004)	1.27±0.1 (0.050±0.004)	2.5±0.1 (0.100±0.004)
T	0.145±0.020 (0.006±0.001)	0.225±0.050 (0.009±0.002)	0.40±0.1 (0.016±0.004)	0.63±0.1 (0.025±0.004)	0.93±0.2 (0.036±0.008)	0.93±0.2 (0.036±0.008)
B1	0.00 ^{+0.1} _{-0.0} (0.004 ^{+0.004} _{-0.000})	0.10±0.10 (0.004±0.004)	(0.0 ^{+0.1} _{-0.0}) (0.00 ^{+0.004} _{-0.000})	0.35±0.15 (0.014±0.006)	0.30±0.1 (0.012±0.004)	0.43±0.1 (0.017±0.004)
B2	0.15±0.05 (0.000±0.002)	0.15±0.05 (0.006±0.002)	0.20±0.1 (0.008±0.004)	0.35±0.15 (0.014±0.006)	0.30±0.1 (0.012±0.004)	0.43±0.1 (0.017±0.004)

*Mount Black Side Up

DIMENSIONS: millimeters (inches)

HOW TO ORDER

0402	3	J	4R7	A	B	S	TR	\500
Size C005 0201 0402 0603 0805 1210*	Voltage 2 = 200V 1 = 100V 5 = 50V 3 = 25V Y = 16V Z = 10V	Temperature Coefficient (1) J = 0±30ppm/°C (-55°C to +125°C) K = 0±60ppm/°C (-55°C to +125°)	Capacitance Capacitance expressed in pF. (2 significant digits + number of zeros) for values <10pF, letter R denotes decimal point. Example: 68pF = 680 8.2pF = 8R2	Tolerance for Cs<2.0pF* Z = ±0.01pF P = ±0.02pF Q = ±0.03pF A = ±0.05pF B = ±0.1pF C = ±0.25pF for Cs<3.0pF Q = ±0.03pF A = ±0.05pF B = ±0.1pF C = ±0.25pF for Cs<5.6pF A = ±0.05pF B = ±0.1pF C = ±0.25pF for 5.6pF<C<10pF B = ±0.1pF C = ±0.25pF D = ±0.5pF for Cs>10pF F = ±1% G = ±2% J = ±5%	Specification Code B = Accu-P® technology	Termination Code W=Nickel/Solder Coated Accu-P® 0402 Sn90, Pb10*** T=Nickel/High Temperature Solder Coated Accu-P® 0805**, 1210** Sn96, Ag4 Nickel/Solder Coated Accu-P® 0603*** Sn63, Pb37 **S=Nickel/Lead Free Solder Coated Accu-P® 1005, 0201 0402, 0603 Sn100	Packaging Code TR = Tape & Reel	Option

**RoHS compliant
*** Not RoHS Compliant

The following 3 digit capacitance codes should be used for ordering Accu-P® capacitors	
CAPACITANCE CODE	EXAMPLE
0.00 to 0.99pF Rxx	0.15pF = 04023JR15ABSTR
1.00 to 1.99pF Axx	1.55pF = 04023JA55PBSTR
2.00 to 2.99pF Bxx	2.85pF =B85...
3.00 to 3.99pF Cxx	3.85pF =C85...
4.00 to 4.99pF Dxx	4.85pF =D85...
5.00 to 5.99pF Exx	5.85pF =E85...
6.00 to 6.99pF Fxx	6.85pF =F85...
7.00 to 7.99pF Gxx	7.85pF =G85...
8.00 to 8.99pF Hxx	8.85pF =H85...
9.00 to 9.99pF Jxx	9.85pF =J85...
10.0 to 19.9pF Kxx	13.8pF =K38...
20.0 to 29.9pF Lxx	22.5pF =L25...
30.0 to 39.9pF Mxx	33.8pF =M38...
40.0 to 49.9pF Nxx	43.5pF =N35...

(1) TC's shown are per EIA/IEC Specifications.
* Tolerances as tight as ±0.01pF are available.
Please consult the factory.



For RoHS compliant products, please select correct termination style.

ELECTRICAL SPECIFICATIONS

Operating and Storage Temperature Range	-55°C to +125°C
Temperature Coefficients (1)	0 ± 30ppm/°C dielectric code "J" / 0 ± 60ppm/°C dielectric code "K"
Capacitance Measurement	1 MHz, 1 Vrms
Insulation Resistance (IR)	≥1011 Ohms (≥10 ¹⁰ Ohms for 0201 and 0402 size)
Proof Voltage	2.5 U _R for 5 secs.
Aging Characteristic	Zero
Dielectric Absorption	0.01%

Thin-Film RF/Microwave Capacitor Technology

Accu-P® Series

Single and Power Type Capacitors



TEMP. COEFFICIENT CODE

"J" = 0±30PPM/°C (-55°C TO +125°C)⁽²⁾ "K" = 0±60PPM/°C (-55°C TO +125°C)⁽²⁾

Size		C005					0201					0402					0603				0805			1210	
Size Code	Voltage	16	100	50	25	16	10	200	100	50	25	16	10	200	100	50	25	100	50	25	100	50			
Cap in pF	Cap code																								
0.1	— 0R1																								
0.2	— 0R2																								
0.3	— 0R3																								
0.4	— 0R4																								
0.5	— 0R5																								
0.6	— 0R6																								
0.7	— 0R7																								
0.8	— 0R8																								
0.9	— 0R9																								
1.0	— 1R0																								
1.1	— 1R1																								
1.2	— 1R2																								
1.3	— 1R3																								
1.4	— 1R4																								
1.5	— 1R5																								
1.6	— 1R6																								
1.7	— 1R7																								
1.8	— 1R8																								
1.9	— 1R9																								
2.0	— 2R0																								
2.1	— 2R1																								
2.2	— 2R2																								
2.3	— 2R3																								
2.4	— 2R4																								
2.5	— 2R5																								
2.6	— 2R6																								
2.7	— 2R7																								
2.8	— 2R8																								
2.9	— 2R9																								
3.0	— 3R0																								
3.1	— 3R1																								
3.2	— 3R2																								
3.3	— 3R3																								
3.4	— 3R4																								
3.5	— 3R5																								
3.6	— 3R6																								
3.7	— 3R7																								
3.8	— 3R8																								
3.9	— 3R9																								
4.0	— 4R0																								
4.1	— 4R1																								
4.2	— 4R2																								
4.3	— 4R3																								
4.4	— 4R4																								
4.5	— 4R5																								
4.6	— 4R6																								
4.7	— 4R7																								
5.1	— 5R1																								
5.6	— 5R6																								
6.2	— 6R2																								
6.8	— 6R8																								
7.5	— 7R5																								
8.2	— 8R2																								
9.1	— 9R1																								
10.0	— 100																								
11.0	— 110																								
12.0	— 120																								
13.0	— 130																								
14.0	— 140																								
15.0	— 150																								
16.0	— 160																								
17.0	— 170																								
18.0	— 180																								
19.0	— 190																								
20.0	— 200																								
21.0	— 210																								
22.0	— 220																								
24.0	— 240																								
27.0	— 270																								
30.0	— 300																								
33.0	— 330																								
39.0	— 390																								
47.0	— 470																								
56.0	— 560																								
68.0	— 680																								

(1) For capacitance values higher than listed in table, please consult factory.
 (2) TC shown is per EIA/IEC Specifications.
 These values are produced with "K" temperature coefficient code only.

Intermediate values are available within the indicated range.

Capacitance @ 1MHz and Tolerance		Self Resonance Frequency (GHz) Typ.	Q Standard Value @ 1GHz		Frequency 900MHz			Frequency 1900MHz			Frequency 2400MHz		
C (pF)	Tol.		Typ.	Min.	C(eff) (pF) Typ.	Q Typ.	ESR (mOhm) Typ.	C(eff) (pF) Typ.	Q Typ.	ESR (mOhm) Typ.	C(eff) (pF) Typ.	Q Typ.	ESR (mOhm) Typ.
0.05	±0.02	20.9	599	402	0.055	650	3220	0.056	265	4010	0.057	195	4450
0.1	±0.02	19.4	574	316	0.110	614	2682	0.112	246	3036	0.113	188	3113
0.15	±0.02	17.9	510	280	0.163	550	2087	0.166	220	2404	0.168	170	2441
0.2	±0.02	16.4	445	245	0.216	520	1693	0.220	210	1971	0.223	160	1970
0.25	±0.02	15.5	436	240	0.262	510	1371	0.268	204	1604	0.272	153	1646
0.3	±0.02	14.6	427	235	0.309	500	1149	0.316	199	1337	0.320	146	1421
0.35	±0.02	14.1	423	232	0.360	494	1001	0.369	196	1177	0.374	144	1265
0.4	±0.02	12.5	418	230	0.411	489	874	0.421	193	1038	0.427	142	1129
0.45	±0.02	11.9	413	227	0.461	484	819	0.473	191	972	0.481	140	1066
0.5	±0.02	11.3	408	224	0.512	478	765	0.526	188	906	0.535	138	1003
0.55	±0.02	10.9	403	222	0.563	473	710	0.578	186	840	0.588	137	940
0.6	±0.02	10.4	398	219	0.614	468	667	0.631	183	791	0.642	135	882
0.65	±0.02	10.0	394	217	0.664	462	624	0.683	181	742	0.695	133	825
0.7	±0.02	9.5	389	214	0.715	457	580	0.735	178	693	0.749	131	767
0.75	±0.02	9.3	384	211	0.766	452	557	0.788	176	664	0.802	129	729
0.8	±0.02	9.1	379	209	0.817	446	534	0.840	173	635	0.856	127	692
0.85	±0.02	8.9	374	206	0.868	441	511	0.893	171	606	0.909	126	654
0.9	±0.02	8.8	370	203	0.918	436	487	0.945	168	577	0.963	124	616
0.95	±0.02	8.6	365	201	0.969	430	464	0.998	166	548	1.016	122	579
1	±0.02	8.4	360	198	1.020	425	441	1.050	163	519	1.070	120	541
1.05	±0.02	8.2	358	197	1.078	421	426	1.112	161	502	1.134	119	523
1.1	±0.02	8.0	355	195	1.135	418	410	1.173	159	486	1.199	117	505
1.15	±0.02	7.8	353	194	1.193	414	395	1.235	157	469	1.263	116	488
1.2	±0.02	7.6	350	193	1.251	411	379	1.296	155	452	1.327	115	470
1.25	±0.02	7.5	348	191	1.308	407	364	1.358	153	436	1.392	114	452
1.3	±0.02	7.4	345	190	1.366	403	348	1.419	151	419	1.456	112	434
1.35	±0.02	7.3	343	189	1.424	400	333	1.481	149	402	1.520	111	416
1.4	±0.02	7.2	340	187	1.481	396	317	1.542	147	386	1.585	110	398
1.45	±0.02	7.1	338	186	1.539	393	302	1.604	145	369	1.649	109	381
1.5	±0.02	7.0	335	184	1.597	389	287	1.665	144	353	1.713	107	363
1.55	±0.02	6.8	332	183	1.642	386	282	1.714	142	347	1.764	106	358
1.6	±0.02	6.7	330	181	1.687	382	277	1.762	141	342	1.815	105	352
1.65	±0.02	6.6	327	180	1.732	378	272	1.810	140	337	1.866	104	347
1.7	±0.02	6.5	324	178	1.777	375	267	1.859	138	331	1.917	103	342
1.75	±0.02	6.4	321	176	1.822	371	262	1.907	137	326	1.968	102	337
1.8	±0.02	6.3	318	175	1.866	367	257	1.955	136	321	2.018	101	331
1.85	±0.02	6.2	315	173	1.911	364	252	2.003	134	316	2.069	100	326
1.9	±0.02	6.2	312	172	1.956	360	247	2.052	133	310	2.120	99	321
1.95	±0.02	6.1	309	170	2.001	357	242	2.100	132	305	2.171	98	316
2	±0.03	6.0	306	168	2.046	353	237	2.148	131	300	2.222	97	310
2.1	±0.03	5.9	301	166	2.150	348	232	2.263	128	293	2.344	95	303
2.2	±0.03	5.7	296	163	2.254	343	227	2.377	125	287	2.467	93	296
2.3	±0.03	5.6	292	160	2.358	337	222	2.491	122	281	2.590	91	289
2.4	±0.03	5.5	287	158	2.462	332	217	2.606	120	274	2.712	89	282
2.5	±0.03	5.4	282	155	2.566	327	212	2.720	117	268	2.835	87	275
2.6	±0.03	5.3	277	152	2.670	322	207	2.834	114	262	2.958	85	268
2.7	±0.03	5.2	272	150	2.773	317	202	2.949	112	255	3.080	83	261
2.8	±0.03	5.1	269	148	2.878	312	199	3.066	110	252	3.209	81	258
2.9	±0.03	5.0	265	146	2.983	308	196	3.184	108	248	3.337	80	254
3	±0.03	4.9	261	144	3.088	304	193	3.301	106	245	3.465	78	251
3.1	±0.05	4.8	257	141	3.192	299	190	3.419	105	241	3.593	77	247
3.2	±0.05	4.7	253	139	3.297	295	187	3.536	103	238	3.722	76	244
3.3	±0.05	4.6	250	137	3.402	291	185	3.654	101	234	3.850	74	240
3.4	±0.05	4.6	246	135	3.506	286	182	3.771	99	231	3.978	73	237
3.5	±0.05	4.5	242	133	3.611	282	179	3.889	98	227	4.107	71	233
3.6	±0.05	4.5	238	131	3.716	278	176	4.006	96	224	4.235	70	230
3.7	±0.05	4.4	234	129	3.820	273	173	4.124	94	220	4.363	69	226
3.8	±0.05	4.4	230	127	3.925	269	170	4.241	92	217	4.492	67	223

Capacitance @ 1MHz and Tolerance		Self Resonance Frequency (GHz) Typ.	Q Standard Value @ 1GHz		Frequency 900MHz			Frequency 1900MHz			Frequency 2400MHz		
C (pF)	Tol.		Typ.	Min.	C(eff) (pF) Typ.	Q Typ.	ESR (mOhm) Typ.	C(eff) (pF) Typ.	Q Typ.	ESR (mOhm) Typ.	C(eff) (pF) Typ.	Q Typ.	ESR (mOhm) Typ.
3.9	±0.05	4.3	227	125	4.030	265	167	4.359	91	213	4.620	66	219
4	±0.05	4.3	224	123	4.138	262	165	4.484	89	210	4.760	65	216
4.1	±0.05	4.2	222	122	4.247	259	162	4.610	88	207	4.901	64	213
4.2	±0.05	4.2	220	121	4.356	257	159	4.735	87	204	5.041	63	210
4.3	±0.05	4.1	218	120	4.464	254	157	4.860	86	201	5.181	62	207
4.4	±0.05	4.1	216	119	4.573	252	154	4.986	85	198	5.322	61	204
4.5	±0.05	4.0	214	118	4.682	249	152	5.111	83	195	5.462	60	201
4.6	±0.05	4.0	212	116	4.790	246	149	5.237	82	192	5.602	59	198
4.7	±0.05	3.9	209	115	4.899	244	147	5.362	81	189	5.743	58	195
5.1	±0.05	3.8	201	110	5.334	233	136	5.863	76	178	6.304	54	183
5.6	±0.05	3.6	190	105	5.877	220	124	6.490	70	163	7.006	49	168
6.2	±0.1	3.5	177	97	6.488	208	126	7.290	65	167	7.993	45	174
6.8	±0.1	3.3	164	90	7.100	195	128	8.090	60	171	8.980	41	179
7.5	±0.1	3.2	153	84	7.901	182	125	9.129	56	166	10.27	38	173
8.2	±0.1	3.0	142	78	8.701	168	121	10.17	52	160	11.56	34	167
9.1	±0.1	2.9	135	74	9.676	159	118	11.57	49	154	13.49	32	161
10	±1%	2.8	128	70	10.65	151	114	12.96	45	148	15.41	29	155
11	±1%	2.7	120	66	11.73	141	110	14.52	42	142	17.55	27	148
12	±1%	2.5	112	62	12.82	132	105	16.07	39	135	19.68	24	141
13	±1%	2.4	105	58	13.92	124	104	17.82	36	135	22.38	22	142
14	±1%	2.4	98	54	15.02	116	103	19.57	32	135	25.08	19	142
15	±1%	2.3	91	50	16.12	108	102	21.32	29	135	27.78	17	143
16	±1%	2.2	86	47	17.37	102	103	24.04	27	135	NA	NA	NA
17	±1%	2.2	81	44	18.63	96	105	26.76	25	136	NA	NA	NA
18	±1%	2.1	76	42	19.88	90	106	29.48	23	136	NA	NA	NA
19	±1%	2.1	71	39	21.14	83	108	32.20	21	136	NA	NA	NA
20	±1%	2.1	65	36	22.39	77	109	34.92	19	136	NA	NA	NA
22	±1%	2.0	55	30	24.90	65	112	40.36	15	137	NA	NA	NA

Capacitance @ 1MHz and Tolerance		Self Resonance Frequency (GHz) Typ.	Q Standard Value @ 1GHz		Frequency 900MHz			Frequency 1900MHz			Frequency 2400MHz		
C (pF)	Tol.		Typ.	Min.	C(eff) (pF) Typ.	Q Typ.	ESR (mOhm) Typ.	C(eff) (pF) Typ.	Q Typ.	ESR (mOhm) Typ.	C(eff) (pF) Typ.	Q Typ.	ESR (mOhm) Typ.
0.05	±0.02	20.9	856	471	0.06	881	1411	0.06	562	1216	0.06	498	983
0.1	±0.02	19.4	848	466	0.11	873	1316	0.11	554	1115	0.11	490	914
0.15	±0.02	17.9	840	462	0.16	866	1222	0.16	547	1013	0.16	482	845
0.2	±0.02	16.4	832	457	0.21	858	1128	0.21	539	912	0.22	474	776
0.25	±0.02	15.5	823	453	0.26	850	1033	0.27	532	810	0.27	465	707
0.3	±0.02	14.6	815	448	0.31	842	939	0.32	525	708	0.32	457	638
0.35	±0.02	14.1	807	444	0.36	834	844	0.37	517	607	0.37	449	569
0.4	±0.02	12.5	799	439	0.41	827	750	0.42	510	505	0.42	441	500
0.45	±0.02	11.9	791	435	0.46	819	667	0.47	502	458	0.48	432	453
0.5	±0.02	11.3	783	430	0.51	811	583	0.52	495	410	0.53	424	407
0.55	±0.02	10.9	774	426	0.57	803	500	0.57	487	363	0.58	416	360
0.6	±0.02	10.4	766	421	0.62	796	465	0.62	480	343	0.63	408	339
0.65	±0.02	10.0	758	417	0.67	788	431	0.67	472	322	0.68	399	317
0.7	±0.02	9.5	750	413	0.72	780	396	0.72	465	302	0.73	391	296
0.75	±0.02	9.3	746	410	0.77	776	375	0.78	456	290	0.79	381	285
0.8	±0.02	9.1	743	408	0.82	772	354	0.83	447	277	0.84	370	273
0.85	±0.02	9.0	739	406	0.87	768	334	0.88	438	265	0.89	360	262
0.9	±0.02	8.8	735	404	0.92	764	313	0.93	429	253	0.95	350	250
0.95	±0.02	8.4	732	402	0.97	760	292	0.98	420	240	1.00	339	239
1	±0.02	8.0	728	400	1.02	756	271	1.04	411	228	1.05	329	227
1.05	±0.02	7.9	725	398	1.07	752	258	1.09	406	221	1.11	323	221
1.1	±0.02	7.8	721	397	1.12	749	245	1.14	401	214	1.16	318	214
1.15	±0.02	7.6	718	395	1.17	745	232	1.20	396	207	1.22	312	208
1.2	±0.02	7.4	714	393	1.22	742	218	1.25	391	200	1.27	306	202
1.25	±0.02	7.2	711	391	1.27	738	205	1.31	386	193	1.32	301	195
1.3	±0.02	7.0	707	389	1.32	734	192	1.36	381	185	1.38	295	189
1.35	±0.02	6.9	704	387	1.37	731	179	1.41	376	178	1.43	289	183
1.4	±0.02	6.8	700	385	1.42	727	165	1.47	371	171	1.49	283	177
1.45	±0.02	6.7	697	383	1.47	724	152	1.52	366	164	1.54	278	170
1.5	±0.02	6.5	693	381	1.52	720	139	1.58	361	157	1.60	272	164
1.55	±0.02	6.5	690	379	1.56	716	135	1.62	358	153	1.65	269	159
1.6	±0.02	6.5	686	377	1.61	713	130	1.67	355	148	1.70	267	155
1.65	±0.02	6.5	683	375	1.66	709	126	1.72	352	143	1.76	264	150
1.7	±0.02	6.4	679	373	1.71	705	122	1.77	349	139	1.81	261	146
1.75	±0.02	6.3	676	372	1.75	702	118	1.82	347	134	1.86	259	141
1.8	±0.02	6.2	672	370	1.80	698	113	1.87	344	130	1.92	256	137
1.85	±0.02	6.1	669	368	1.85	694	109	1.92	341	125	1.97	253	132
1.9	±0.02	6.0	665	366	1.90	690	105	1.97	338	121	2.02	251	128
1.95	±0.02	5.9	662	364	1.94	687	101	2.01	335	116	2.08	248	123
2	±0.03	5.7	658	362	1.99	683	96	2.06	332	112	2.13	245	119
2.1	±0.03	5.4	651	358	2.10	676	93	2.18	326	108	2.26	241	115
2.2	±0.03	5.1	643	354	2.21	669	89	2.30	321	104	2.38	236	112
2.3	±0.03	5.0	636	350	2.31	662	85	2.42	315	101	2.51	231	109
2.4	±0.03	4.9	629	346	2.42	656	81	2.54	309	97	2.64	226	106
2.5	±0.03	4.7	622	342	2.53	649	77	2.65	303	94	2.76	221	102
2.6	±0.03	4.6	614	338	2.64	642	74	2.77	298	90	2.89	216	99
2.7	±0.03	4.5	607	334	2.75	635	70	2.89	292	86	3.02	211	96
2.8	±0.03	4.5	600	330	2.85	628	68	3.01	288	83	3.15	207	92
2.9	±0.03	4.4	592	326	2.95	621	66	3.13	283	80	3.28	203	88
3	±0.03	4.4	585	322	3.06	614	64	3.24	279	76	3.41	200	84
3.1	±0.05	4.4	578	318	3.16	607	62	3.36	274	73	3.54	196	80
3.2	±0.05	4.3	570	314	3.27	600	60	3.48	270	70	3.67	192	76
3.3	±0.05	4.3	563	310	3.37	593	58	3.60	265	67	3.80	188	72
3.4	±0.05	4.3	556	306	3.47	586	57	3.71	261	63	3.93	184	68
3.5	±0.05	4.2	548	302	3.58	579	55	3.83	256	60	4.06	180	64
3.6	±0.05	4.2	541	298	3.68	572	53	3.95	252	57	4.19	177	60
3.7	±0.05	4.1	534	294	3.78	565	51	4.06	247	54	4.32	173	56
3.8	±0.05	4.0	526	289	3.89	558	49	4.18	243	50	4.45	169	52

Thin-Film RF/Microwave Capacitor Technology

Accu-P® Series

0402 Typical Electrical Tables



Capacitance @ 1MHz and Tolerance		Self Resonance Frequency (GHz) Typ.	Q Standard Value @ 1GHz		Frequency 900MHz			Frequency 1900MHz			Frequency 2400MHz		
C (pF)	Tol.		Typ.	Min.	C(eff) (pF) Typ.	Q Typ.	ESR (mOhm) Typ.	C(eff) (pF) Typ.	Q Typ.	ESR (mOhm) Typ.	C(eff) (pF) Typ.	Q Typ.	ESR (mOhm) Typ.
3.9	±0.05	3.9	519	285	3.99	551	47	4.30	238	47	4.58	165	48
4	±0.05	3.9	513	282	4.10	545	47	4.42	235	47	4.73	162	48
4.1	±0.05	3.8	507	279	4.20	539	47	4.55	232	46	4.87	160	48
4.2	±0.05	3.8	501	275	4.30	534	46	4.67	228	46	5.01	157	48
4.3	±0.05	3.7	495	272	4.41	528	46	4.79	225	46	5.16	154	48
4.4	±0.05	3.7	489	269	4.51	522	46	4.92	222	46	5.30	151	47
4.5	±0.05	3.6	483	265	4.61	516	46	5.04	219	45	5.44	149	47
4.6	±0.05	3.6	477	262	4.72	511	45	5.16	216	45	5.59	146	47
4.7	±0.05	3.5	471	259	4.82	505	45	5.29	213	45	5.73	143	47
5.1	±0.05	3.4	446	245	5.23	482	44	5.78	200	43	6.30	133	47
5.6	±0.05	3.3	416	229	5.75	453	43	6.40	184	42	7.02	119	46
6.2	±0.1	3.0	388	213	6.41	427	44	7.26	167	44	8.11	107	47
6.8	±0.1	2.8	360	198	7.07	400	44	8.12	150	45	9.19	95	48
7.5	±0.1	2.7	338	186	7.85	378	45	9.17	139	47	10.57	86	49
8.2	±0.1	2.6	315	173	8.62	356	45	10.22	128	48	11.95	77	50
9.1	±0.1	2.5	292	160	9.63	333	45	11.75	115	47	14.23	69	50
10	±1%	2.4	268	148	10.65	310	45	13.28	103	47	16.50	61	49
11	±1%	2.3	242	133	11.77	285	44	14.98	89	46	19.04	51	49
12	±1%	2.2	217	119	12.90	259	44	16.68	75	45	21.57	42	48
13	±1%	2.2	202	111	14.03	241	44	18.83	68	47	25.73	38	49
14	±1%	2.1	187	103	15.17	223	44	20.97	62	49	29.89	33	49
15	±1%	2.1	172	94	16.30	204	45	23.12	56	51	34.05	29	50
16	±1%	2.0	157	87	17.53	187	44	25.91	50	49	41.44	25	49
17	±1%	1.9	143	79	18.75	169	43	28.70	45	46	48.82	21	47
18	±1%	1.8	129	71	19.98	152	42	31.49	39	44	56.21	17	46
19	±1%	1.8	121	67	21.11	143	42	33.51	36	44	60.92	15	47
20	±1%	1.8	110	61	22.25	131	41	35.53	33	43	65.63	14	48
22	±1%	1.8	98	54	24.51	116	41	39.57	26	42	75.05	10	51
24	±1%	1.8	87	48	27.51	104	37	54.94	21	35	NA	NA	NA
27	±1%	1.7	70	39	32.01	85	32	77.98	13	23	NA	NA	NA
30	±1%	1.7	65	36	35.89	78	28	106.50	10	12	NA	NA	NA
33	±1%	1.7	60	33	40.05	74	27	NA	NA	NA	NA	NA	NA
36	±1%	1.7	58	32	45.13	71	28	NA	NA	NA	NA	NA	NA
39	±1%	1.7	56	31	50.21	69	28	NA	NA	NA	NA	NA	NA
43	±1%	1.6	53	29	56.98	66	29	NA	NA	NA	NA	NA	NA
47	±1%	1.6	50	28	63.75	63	30	NA	NA	NA	NA	NA	NA
51	±1%	1.6	48	26	70.53	60	31	NA	NA	NA	NA	NA	NA
56	±1%	1.6	44	24	78.99	56	33	NA	NA	NA	NA	NA	NA
58	±1%	1.6	42	23	83.54	54	34	NA	NA	NA	NA	NA	NA
68	±1%	1.6	32	18	106.28	42	40	NA	NA	NA	NA	NA	NA

Capacitance @ 1MHz and Tolerance		Self Resonance Frequency (GHz) Typ.	Q Standard Value @ 1GHz		Frequency 900MHz			Frequency 1900MHz			Frequency 2400MHz		
C (pF)	Tol.		Typ.	Min.	C(eff) (pF) Typ.	Q Typ.	ESR (mOhm) Typ.	C(eff) (pF) Typ.	Q Typ.	ESR (mOhm) Typ.	C(eff) (pF) Typ.	Q Typ.	ESR (mOhm) Typ.
0.05	±0.02	25.6	1200	660	0.06	1333	945	0.06	556	832	0.06	397	880
0.1	±0.02	18.1	1156	636	0.11	1284	675	0.11	535	628	0.11	382	667
0.15	±0.02	14.8	1111	611	0.16	1235	555	0.16	514	533	0.16	367	567
0.2	±0.02	12.8	1067	587	0.21	1185	483	0.21	494	474	0.22	353	505
0.25	±0.02	11.4	1022	562	0.26	1136	433	0.27	473	433	0.27	338	462
0.3	±0.02	10.4	978	538	0.31	1086	397	0.32	453	402	0.32	323	430
0.35	±0.02	9.7	933	513	0.36	1037	368	0.37	432	378	0.37	309	404
0.4	±0.02	9.0	889	489	0.41	988	345	0.42	412	358	0.42	294	383
0.45	±0.02	8.5	844	464	0.46	938	326	0.47	391	341	0.48	279	365
0.5	±0.02	8.1	800	440	0.51	889	310	0.52	370	327	0.53	265	350
0.55	±0.02	7.7	788	434	0.57	875	296	0.57	363	315	0.58	261	337
0.6	±0.02	7.4	777	427	0.62	860	283	0.62	356	304	0.63	258	326
0.65	±0.02	7.1	765	421	0.67	846	273	0.67	348	294	0.68	255	315
0.7	±0.02	6.8	754	414	0.72	832	263	0.72	341	285	0.73	252	306
0.75	±0.02	6.6	742	408	0.77	817	254	0.78	334	277	0.79	248	298
0.8	±0.02	6.4	730	402	0.82	803	247	0.83	326	270	0.84	245	290
0.85	±0.02	6.2	719	395	0.87	789	239	0.88	319	264	0.89	242	283
0.9	±0.02	6.0	707	389	0.92	775	233	0.93	312	258	0.95	239	277
0.95	±0.02	5.9	696	383	0.97	760	227	0.98	304	252	1.00	235	271
1	±0.02	5.7	684	376	1.019	746	216	1.061	297	242	1.101	232	260
1.05	±0.02	5.6	667	367	1.076	731	213	1.126	290	239	1.171	226	256
1.1	±0.02	5.4	649	357	1.134	717	210	1.190	282	236	1.241	220	253
1.15	±0.02	5.3	632	347	1.192	702	206	1.254	275	233	1.311	214	250
1.2	±0.02	5.2	614	338	1.250	687	203	1.318	267	230	1.381	209	247
1.25	±0.02	5.1	605	333	1.307	677	200	1.382	262	227	1.451	203	244
1.3	±0.02	5.0	596	328	1.365	667	197	1.446	257	224	1.521	197	241
1.35	±0.02	4.9	587	323	1.423	658	194	1.511	252	221	1.591	191	238
1.4	±0.02	4.8	578	318	1.481	648	190	1.575	247	218	1.661	185	235
1.45	±0.02	4.8	569	313	1.538	638	187	1.639	242	215	1.731	179	232
1.5	±0.02	4.7	560	308	1.596	628	184	1.703	237	212	1.801	173	229
1.55	±0.02	4.6	551	303	1.645	620	181	1.760	233	209	1.866	170	226
1.6	±0.02	4.5	542	298	1.694	611	178	1.817	228	206	1.930	166	222
1.65	±0.02	4.5	534	293	1.743	603	175	1.874	224	203	1.995	163	219
1.7	±0.02	4.4	525	289	1.792	595	172	1.931	219	200	2.060	159	216
1.75	±0.02	4.3	516	284	1.841	587	169	1.988	215	197	2.124	156	213
1.8	±0.02	4.2	507	279	1.890	578	166	2.045	211	194	2.189	153	209
1.85	±0.02	4.2	498	274	1.939	570	163	2.102	206	191	2.253	149	206
1.9	±0.02	4.1	490	269	1.988	562	160	2.158	202	188	2.318	146	203
1.95	±0.02	4.1	481	264	2.037	553	157	2.215	197	185	2.383	142	199
2	±0.03	4.0	472	260	2.086	545	154	2.272	193	182	2.447	139	196
2.1	±0.03	3.9	462	254	2.190	535	151	2.402	187	180	2.604	134	193
2.2	±0.03	3.8	452	249	2.295	524	148	2.532	181	177	2.761	129	191
2.3	±0.03	3.8	442	243	2.400	514	145	2.662	175	175	2.917	124	188
2.4	±0.03	3.7	433	238	2.504	503	143	2.793	168	172	3.074	118	186
2.5	±0.03	3.6	423	232	2.609	493	140	2.923	162	170	3.230	113	183
2.6	±0.03	3.6	413	227	2.714	482	137	3.053	156	167	3.387	108	181
2.7	±0.03	3.5	403	222	2.818	472	134	3.183	150	165	3.543	103	178
2.8	±0.03	3.4	395	217	2.933	463	133	3.336	147	164	3.742	100	177
2.9	±0.03	3.4	388	213	3.047	453	131	3.489	144	162	3.940	97	175
3	±0.03	3.3	380	209	3.162	444	130	3.642	140	161	4.139	95	174
3.1	±0.05	3.2	372	205	3.276	435	129	3.795	137	160	4.337	92	172
3.2	±0.05	3.2	365	201	3.391	425	127	3.947	134	159	4.536	89	171
3.3	±0.05	3.1	357	196	3.506	416	126	4.100	131	157	4.734	86	169
3.4	±0.05	3.1	349	192	3.620	407	125	4.253	128	156	4.933	84	168
3.5	±0.05	3.1	342	188	3.735	397	123	4.406	125	155	5.131	81	166
3.6	±0.05	3.0	334	184	3.849	388	122	4.559	121	154	5.330	78	165
3.7	±0.05	3.0	326	179	3.964	379	121	4.712	118	152	5.528	75	164
3.8	±0.05	3.0	318	175	4.078	369	119	4.865	115	151	5.727	73	162

Capacitance @ 1MHz and Tolerance		Self Resonance Frequency (GHz) Typ.	Q Standard Value @ 1GHz		Frequency 900MHz			Frequency 1900MHz			Frequency 2400MHz		
C (pF)	Tol.		Typ.	Min.	C(eff) (pF) Typ.	Q Typ.	ESR (mOhm) Typ.	C(eff) (pF) Typ.	Q Typ.	ESR (mOhm) Typ.	C(eff) (pF) Typ.	Q Typ.	ESR (mOhm) Typ.
3.9	±0.05	2.9	311	171	4.193	360	118	5.018	112	150	5.925	70	161
4	±0.05	2.9	307	169	4.301	355	117	5.188	110	149	6.188	68	160
4.1	±0.05	2.8	303	167	4.410	351	116	5.358	108	148	6.450	67	159
4.2	±0.05	2.8	299	164	4.518	347	116	5.528	106	148	6.713	65	158
4.3	±0.05	2.7	295	162	4.627	342	115	5.698	104	147	6.975	64	157
4.4	±0.05	2.7	291	160	4.735	338	114	5.867	102	146	7.238	62	157
4.5	±0.05	2.7	287	158	4.843	333	113	6.037	100	146	7.500	61	156
4.6	±0.05	2.6	283	156	4.952	329	112	6.207	98	145	7.763	59	155
4.7	±0.05	2.6	279	154	5.060	324	112	6.377	96	144	8.025	58	154
5.1	±0.05	2.5	263	145	5.494	307	109	7.057	88	142	9.075	52	151
5.6	±0.05	2.4	244	134	6.035	285	105	7.906	78	138	10.39	44	147
6.2	±0.1	2.3	228	126	6.865	267	102	9.517	72	133	13.66	40	141
6.8	±0.1	2.2	213	117	7.694	250	100	11.13	66	128	16.93	35	135
7.5	±0.1	2.1	195	107	8.367	227	98	12.63	57	125	20.91	28	132
8.2	±0.1	2.0	176	97	9.041	205	96	14.14	49	123	24.88	21	129
9.1	±0.1	1.9	161	89	10.20	188	96	18.09	42	122	40.00	16	128
10	±1%	1.8	146	80	11.37	171	95	22.05	36	121	70.00	12	127
11	±1%	1.7	129	71	12.66	153	95	26.44	29	120	140.0	6	126
12	±1%	1.6	112	62	13.95	134	94	30.83	22	119	231.3	1	125
13	±1%	1.6	102	56	15.31	122	93	40.37	18	118	n/a	n/a	n/a
14	±1%	1.5	92	51	16.67	111	92	49.91	15	118	n/a	n/a	n/a
15	±1%	1.5	82	45	18.03	99	90	59.44	11	117	n/a	n/a	n/a
16	±1%	1.4	79	43	19.61	96	90	80.00	8	117	n/a	n/a	n/a
17	±1%	1.4	76	42	21.18	92	90	120.0	6	116	n/a	n/a	n/a
18	±1%	1.3	73	40	22.76	89	90	190.0	4	116	n/a	n/a	n/a
19	±1%	1.3	69	38	24.37	84	89	n/a	n/a	n/a	n/a	n/a	n/a
20	±1%	1.2	65	36	25.98	80	89	n/a	n/a	n/a	n/a	n/a	n/a
22	±1%	1.2	57	31	29.21	72	87	n/a	n/a	n/a	n/a	n/a	n/a
24	±1%	1.2	48	26	34.44	62	87	n/a	n/a	n/a	n/a	n/a	n/a
27	±1%	1.1	43	24	41.87	56	86	n/a	n/a	n/a	n/a	n/a	n/a
30	±1%	1.0	37	21	49.29	49	85	n/a	n/a	n/a	n/a	n/a	n/a
33	±1%	1.0	32	18	56.72	43	84	n/a	n/a	n/a	n/a	n/a	n/a
36	±1%	1.0	27	15	64.15	37	83	n/a	n/a	n/a	n/a	n/a	n/a
39	±1%	1.0	21	12	71.57	30	82	n/a	n/a	n/a	n/a	n/a	n/a

Capacitance @ 1MHz and Tolerance		Self Resonance Frequency (GHz) Typ.	Q Standard Value @ 1GHz		Frequency 900MHz			Frequency 1900MHz			Frequency 2400MHz		
C (pF)	Tol.		Typ.	Min.	C(eff) (pF) Typ.	Q Typ.	ESR (mOhm) Typ.	C(eff) (pF) Typ.	Q Typ.	ESR (mOhm) Typ.	C(eff) (pF) Typ.	Q Typ.	ESR (mOhm) Typ.
0.1	±0.02	17.2	880	484	0.125	890	3296	0.125	545	2417	0.126	447	2265
0.15	±0.02	14.1	872	480	0.176	885	2073	0.178	530	1626	0.181	434	1546
0.2	±0.02	12.3	864	475	0.228	880	1492	0.231	516	1227	0.235	420	1178
0.25	±0.02	11.0	857	471	0.279	874	1156	0.284	501	986	0.290	407	955
0.3	±0.02	10.1	849	467	0.331	869	938	0.337	487	825	0.344	394	804
0.35	±0.02	9.4	841	462	0.382	864	787	0.390	472	710	0.399	380	695
0.4	±0.02	8.8	833	458	0.433	859	675	0.443	458	623	0.453	367	613
0.45	±0.02	8.3	825	454	0.485	853	590	0.496	443	555	0.508	353	549
0.5	±0.02	7.9	817	450	0.536	848	523	0.549	429	501	0.562	340	497
0.55	±0.02	7.5	811	446	0.584	843	469	0.600	420	456	0.616	331	454
0.6	±0.02	7.2	805	443	0.631	838	425	0.651	411	419	0.670	322	418
0.65	±0.02	6.9	798	439	0.679	834	387	0.702	402	387	0.724	313	388
0.7	±0.02	6.7	792	436	0.726	829	356	0.753	393	360	0.778	304	362
0.75	±0.02	6.5	786	432	0.774	824	329	0.804	384	337	0.832	295	339
0.8	±0.02	6.3	779	429	0.822	819	306	0.855	375	316	0.886	286	319
0.85	±0.02	6.1	773	425	0.869	814	285	0.906	366	298	0.940	277	301
0.9	±0.02	5.9	767	422	0.917	810	267	0.957	357	282	0.994	268	285
0.95	±0.02	5.8	760	418	0.964	805	251	1.008	348	267	1.049	260	271
1	±0.02	5.6	754	415	1.012	800	231	1.059	339	235	1.103	251	242
1.05	±0.02	5.5	747	411	1.065	794	223	1.120	335	228	1.170	247	235
1.1	±0.02	5.4	740	407	1.119	788	215	1.181	330	221	1.237	244	228
1.15	±0.02	5.3	732	403	1.172	782	208	1.242	326	214	1.304	240	220
1.2	±0.02	5.1	725	399	1.225	776	200	1.304	322	207	1.371	237	213
1.25	±0.02	5.0	718	395	1.279	770	192	1.365	318	200	1.438	233	206
1.3	±0.02	4.9	711	391	1.332	764	184	1.426	313	193	1.505	230	199
1.35	±0.02	4.9	704	387	1.386	758	176	1.487	309	186	1.573	226	192
1.4	±0.02	4.8	696	383	1.439	752	169	1.548	305	179	1.640	223	184
1.45	±0.02	4.7	689	379	1.492	746	161	1.609	300	172	1.707	219	177
1.5	±0.02	4.6	682	375	1.546	740	153	1.670	296	165	1.774	216	170
1.55	±0.02	4.6	675	371	1.600	733	151	1.734	292	163	1.850	212	168
1.6	±0.02	4.5	668	367	1.654	726	148	1.799	287	161	1.927	208	165
1.65	±0.02	4.4	660	363	1.708	719	146	1.864	283	159	2.003	204	163
1.7	±0.02	4.3	653	359	1.762	712	143	1.928	278	157	2.079	200	160
1.75	±0.02	4.3	646	355	1.816	705	141	1.993	274	155	2.156	197	158
1.8	±0.02	4.2	639	351	1.870	698	139	2.058	269	152	2.232	193	155
1.85	±0.02	4.2	632	347	1.924	691	136	2.122	265	150	2.308	189	153
1.9	±0.02	4.1	624	343	1.978	684	134	2.187	260	148	2.385	185	150
1.95	±0.02	4.1	617	339	2.033	677	131	2.252	256	146	2.461	181	148
2	±0.03	4.0	610	336	2.087	670	129	2.316	251	144	2.537	177	145
2.1	±0.03	3.9	597	328	2.183	658	127	2.440	245	142	2.690	171	143
2.2	±0.03	3.8	584	321	2.280	646	124	2.563	239	139	2.843	165	141
2.3	±0.03	3.8	571	314	2.377	634	122	2.687	233	137	2.996	159	139
2.4	±0.03	3.6	557	307	2.474	623	119	2.810	227	135	3.149	154	136
2.5	±0.03	3.6	544	299	2.571	611	117	2.934	221	133	3.301	148	134
2.6	±0.03	3.6	531	292	2.668	599	114	3.057	215	130	3.454	142	132
2.7	±0.03	3.4	518	285	2.764	587	112	3.181	209	128	3.607	136	130
2.8	±0.03	3.4	507	279	2.875	575	111	3.348	204	127	3.850	132	129
2.9	±0.03	3.4	497	273	2.987	564	110	3.514	199	125	4.093	129	127
3	±0.03	3.3	486	267	3.098	552	109	3.681	194	124	4.335	125	126
3.1	±0.05	3.3	475	261	3.209	540	108	3.848	189	123	4.578	121	125
3.2	±0.05	3.2	465	256	3.320	528	107	4.014	183	122	4.821	118	123
3.3	±0.05	3.1	454	250	3.431	517	106	4.181	178	120	5.064	114	122
3.4	±0.05	3.1	443	244	3.542	505	105	4.348	173	119	5.307	110	121
3.5	±0.05	3.1	433	238	3.653	493	104	4.515	168	118	5.549	107	119
3.6	±0.05	3.0	422	232	3.764	481	103	4.681	163	116	5.792	103	118
3.7	±0.05	3.0	412	226	3.875	470	102	4.848	158	115	6.035	99	116
3.8	±0.05	3.0	401	220	3.986	458	101	5.015	153	114	6.278	96	115
3.9	±0.05	2.9	390	215	4.097	446	100	5.182	148	113	6.521	92	114
4	±0.05	2.9	384	211	4.214	440	99	5.378	144	112	6.861	89	113
4.1	±0.05	2.9	378	208	4.331	434	98	5.574	141	112	7.201	86	113
4.2	±0.05	2.8	372	205	4.448	428	98	5.769	138	111	7.541	84	112

0805 Typical Electrical Tables

Capacitance @ 1MHz and Tolerance		Self Resonance Frequency (GHz) Typ.	Q Standard Value @ 1GHz		Frequency 900MHz			Frequency 1900MHz			Frequency 2400MHz		
C (pF)	Tol.		Typ.	Min.	C(eff) (pF) Typ.	Q Typ.	ESR (mOhm) Typ.	C(eff) (pF) Typ.	Q Typ.	ESR (mOhm) Typ.	C(eff) (pF) Typ.	Q Typ.	ESR (mOhm) Typ.
4.3	±0.05	2.7	366	202	4.564	422	97	5.965	134	111	7.881	81	111
4.4	±0.05	2.7	360	198	4.681	415	96	6.161	131	110	8.222	78	111
4.5	±0.05	2.7	355	195	4.798	409	96	6.357	128	110	8.562	75	110
4.6	±0.05	2.7	349	192	4.915	403	95	6.553	124	109	8.902	72	110
4.7	±0.05	2.6	343	188	5.032	397	94	6.749	121	109	9.242	69	109
5.1	±0.05	2.5	319	175	5.499	373	91	7.533	108	107	10.60	58	107
5.6	±0.05	2.4	289	159	6.083	342	88	8.513	91	104	12.30	44	104
6.2	±0.1	2.3	264	145	6.842	313	86	10.43	79	102	18.03	36	103
6.8	±0.1	2.2	239	131	7.601	283	84	12.35	68	101	23.76	28	102
7.5	±0.1	2.1	218	120	8.468	259	83	14.84	61	100	37.25	21	101
8.2	±0.1	2.0	198	109	9.334	234	82	17.32	55	100	50.74	15	100
9.1	±0.1	1.9	179	99	10.57	213	82	24.90	46	100	n/a	n/a	n/a
10	±1%	1.8	160	88	11.80	191	81	32.48	37	100	n/a	n/a	n/a
11	±1%	1.7	139	77	13.17	167	81	40.90	26	101	n/a	n/a	n/a
12	±1%	1.6	119	65	14.54	143	80	49.32	16	101	n/a	n/a	n/a
13	±1%	1.6	110	60	16.17	134	80	n/a	n/a	n/a	n/a	n/a	n/a
14	±1%	1.5	101	55	17.79	125	80	n/a	n/a	n/a	n/a	n/a	n/a
15	±1%	1.5	92	51	19.42	116	80	n/a	n/a	n/a	n/a	n/a	n/a
16	±1%	1.4	87	48	21.13	110	79	n/a	n/a	n/a	n/a	n/a	n/a
17	±1%	1.4	83	46	22.85	104	78	n/a	n/a	n/a	n/a	n/a	n/a
18	±1%	1.3	78	43	24.57	99	77	n/a	n/a	n/a	n/a	n/a	n/a
19	±1%	1.3	73	40	26.41	92	77	n/a	n/a	n/a	n/a	n/a	n/a
20	±1%	1.3	67	37	28.26	85	76	n/a	n/a	n/a	n/a	n/a	n/a
22	±1%	1.2	57	31	31.95	72	76	n/a	n/a	n/a	n/a	n/a	n/a
24	±1%	1.2	46	25	35.64	59	75	n/a	n/a	n/a	n/a	n/a	n/a
27	±1%	1.1	41	22	44.94	54	74	n/a	n/a	n/a	n/a	n/a	n/a
30	±1%	1.0	36	20	54.24	48	73	n/a	n/a	n/a	n/a	n/a	n/a
33	±1%	1.0	30	17	63.54	42	72	n/a	n/a	n/a	n/a	n/a	n/a
36	±1%	0.9	25	14	72.84	37	71	n/a	n/a	n/a	n/a	n/a	n/a
39	±1%	0.9	20	11	82.14	31	70	n/a	n/a	n/a	n/a	n/a	n/a
43	±1%	0.9	16	9	102.9	27	66	n/a	n/a	n/a	n/a	n/a	n/a
47	±1%	0.8	12	7	123.7	23	63	n/a	n/a	n/a	n/a	n/a	n/a

Capacitance @ 1MHz and Tolerance		Self Resonance Frequency (GHz) Typ.	Q Standard Value @ 1GHz		Frequency 900MHz			Frequency 1900MHz			Frequency 2400MHz		
C (pF)	Tol.		Typ.	Min.	C(eff) (pF) Typ.	Q Typ.	ESR (mOhm) Typ.	C(eff) (pF) Typ.	Q Typ.	ESR (mOhm) Typ.	C(eff) (pF) Typ.	Q Typ.	ESR (mOhm) Typ.
0.1	±0.02	15.6	1190	654	0.136	1176	3633	0.136	606	2149	0.136	450	2068
0.15	±0.03	12.7	1179	648	0.190	1166	2129	0.190	597	1407	0.191	444	1370
0.2	±0.02	11.0	1168	642	0.244	1156	1457	0.244	589	1042	0.246	438	1023
0.25	±0.02	9.8	1156	636	0.297	1145	1086	0.299	581	826	0.301	432	816
0.3	±0.02	8.9	1145	630	0.351	1135	854	0.353	573	683	0.356	426	678
0.35	±0.02	8.3	1134	624	0.405	1125	697	0.408	565	581	0.411	421	580
0.4	±0.02	7.7	1123	618	0.459	1115	584	0.462	557	505	0.466	415	506
0.45	±0.02	7.3	1112	612	0.513	1105	500	0.516	549	447	0.521	409	449
0.5	±0.02	6.9	1101	606	0.567	1095	435	0.571	541	400	0.576	403	404
0.55	±0.02	6.6	1090	599	0.617	1084	384	0.621	532	362	0.627	397	366
0.6	±0.02	6.3	1079	593	0.666	1074	342	0.672	524	331	0.679	391	335
0.65	±0.02	6.0	1068	587	0.716	1064	308	0.723	516	304	0.731	385	309
0.7	±0.02	5.8	1057	581	0.765	1054	279	0.774	508	282	0.783	379	287
0.75	±0.02	5.6	1046	575	0.815	1044	255	0.824	500	262	0.834	374	267
0.8	±0.02	5.4	1035	569	0.864	1034	234	0.875	492	245	0.886	368	250
0.85	±0.02	5.3	1023	563	0.914	1024	216	0.926	484	230	0.938	362	236
0.9	±0.02	5.1	1012	557	0.963	1013	201	0.976	476	217	0.989	356	222
0.95	±0.02	5.0	1001	551	1.013	1003	187	1.027	467	205	1.041	350	210
1	±0.02	5.0	992	546	1.062	983	167	1.078	459	170	1.093	344	177
1.05	±0.02	4.9	981	539	1.107	975	163	1.124	451	167	1.141	338	174
1.1	±0.02	4.8	969	533	1.152	966	158	1.170	443	165	1.189	331	172
1.15	±0.02	4.7	958	527	1.196	958	154	1.217	435	162	1.236	325	169
1.2	±0.02	4.6	946	521	1.241	950	150	1.263	427	160	1.284	318	167
1.25	±0.02	4.5	935	514	1.285	942	146	1.309	419	157	1.332	312	164
1.3	±0.02	4.4	923	508	1.330	933	142	1.355	410	155	1.380	305	162
1.35	±0.02	4.3	912	502	1.375	925	138	1.402	402	152	1.428	299	159
1.4	±0.02	4.2	900	495	1.419	917	134	1.448	394	150	1.476	293	156
1.45	±0.02	4.1	889	489	1.464	908	129	1.494	386	147	1.524	286	154
1.5	±0.02	4.1	877	483	1.508	900	125	1.541	378	144	1.572	280	151
1.55	±0.02	4.0	862	474	1.567	890	123	1.618	371	143	1.638	274	150
1.6	±0.02	3.9	846	465	1.626	881	122	1.694	363	142	1.704	268	149
1.65	±0.02	3.9	831	457	1.685	871	120	1.771	356	140	1.770	262	148
1.7	±0.02	3.8	815	448	1.743	862	118	1.848	349	139	1.836	256	147
1.75	±0.02	3.7	800	440	1.802	852	116	1.925	342	138	1.902	250	145
1.8	±0.02	3.7	784	431	1.861	843	114	2.002	334	136	1.968	244	144
1.85	±0.02	3.6	769	423	1.920	833	112	2.079	327	135	2.034	239	143
1.9	±0.02	3.5	753	414	1.978	824	110	2.156	320	134	2.100	233	142
1.95	±0.02	3.4	737	406	2.037	814	108	2.233	313	132	2.167	227	141
2	±0.03	3.3	722	397	2.096	805	107	2.310	305	131	2.233	221	139
2.1	±0.03	3.2	691	380	2.213	786	103	2.464	291	128	2.365	209	137
2.2	±0.03	3.0	660	363	2.331	767	99	2.618	276	126	2.497	198	135
2.3	±0.03	2.9	644	354	2.420	747	97	2.681	268	123	2.613	191	132
2.4	±0.03	2.9	629	346	2.508	728	96	2.744	259	121	2.729	185	130
2.5	±0.03	2.8	614	338	2.597	709	94	2.807	251	118	2.845	179	128
2.6	±0.03	2.8	598	329	2.686	689	93	2.870	242	116	2.961	173	126
2.7	±0.03	2.7	583	321	2.775	670	91	2.933	234	114	3.077	167	123
2.8	±0.03	2.7	574	316	2.875	659	90	3.047	230	113	3.205	164	122
2.9	±0.03	2.7	566	311	2.975	647	89	3.162	227	112	3.334	161	121
3	±0.03	2.7	557	306	3.075	636	88	3.276	223	111	3.462	157	121
3.1	±0.05	2.7	548	302	3.174	625	87	3.390	220	110	3.590	154	120
3.2	±0.05	2.6	540	297	3.274	613	87	3.504	216	109	3.718	151	119
3.3	±0.05	2.6	531	292	3.374	602	86	3.619	213	108	3.847	148	118
3.4	±0.05	2.6	522	287	3.474	591	85	3.733	209	107	3.975	145	117
3.5	±0.05	2.6	514	283	3.574	579	84	3.847	206	106	4.103	141	116
3.6	±0.05	2.5	505	278	3.674	568	83	3.961	202	105	4.231	138	115
3.7	±0.05	2.5	496	273	3.773	556	82	4.076	198	104	4.359	135	114
3.8	±0.05	2.5	488	268	3.873	545	81	4.190	195	103	4.488	132	113

Thin-Film RF/Microwave Capacitor Technology

Accu-P® Series

1210 Typical Electrical Tables



Capacitance @ 1MHz and Tolerance		Self Resonance Frequency (GHz) Typ.	Q Standard Value @ 1GHz		Frequency 900MHz			Frequency 1900MHz			Frequency 2400MHz		
C (pF)	Tol.		Typ.	Min.	C(eff) (pF) Typ.	Q Typ.	ESR (mOhm) Typ.	C(eff) (pF) Typ.	Q Typ.	ESR (mOhm) Typ.	C(eff) (pF) Typ.	Q Typ.	ESR (mOhm) Typ.
3.9	±0.05	2.4	479	264	3.973	534	80	4.304	191	102	4.616	129	112
4	±0.05	2.4	473	260	4.083	528	79	4.435	189	101	4.768	127	112
4.1	±0.05	2.4	467	257	4.192	522	78	4.565	186	100	4.919	125	111
4.2	±0.05	2.4	462	254	4.302	516	78	4.695	183	100	5.071	123	110
4.3	±0.05	2.3	456	251	4.411	511	77	4.825	180	99	5.223	121	110
4.4	±0.05	2.3	450	247	4.521	505	76	4.956	178	98	5.375	119	109
4.5	±0.05	2.3	444	244	4.630	499	75	5.086	175	98	5.526	117	108
4.6	±0.05	2.3	438	241	4.740	493	75	5.216	172	97	5.678	115	108
4.7	±0.05	2.2	432	238	4.849	487	74	5.347	170	96	5.830	113	107
5.1	±0.05	2.1	408	225	5.288	464	71	5.868	159	93	6.437	106	105
5.6	±0.05	2.0	379	208	5.835	435	67	6.519	145	90	7.195	96	102
6.2	±0.1	1.9	355	195	6.440	408	65	7.176	137	86	7.897	91	96
6.8	±0.1	1.8	330	182	7.044	380	62	7.832	129	83	8.599	85	91
7.5	±0.1	1.7	308	169	7.823	351	61	8.927	115	81	10.08	74	89
8.2	±0.1	1.7	285	157	8.601	322	60	10.02	100	78	11.55	63	87
9.1	±0.1	1.6	266	146	9.600	304	58	11.55	93	77	13.93	57	85
10	±1%	1.5	247	136	10.60	285	57	13.09	85	76	16.30	50	84
11	±1%	1.5	225	124	11.71	265	56	14.79	76	74	18.94	43	82
12	±1%	1.4	204	112	12.82	244	54	16.49	68	73	21.57	36	81
13	±1%	1.3	193	106	13.97	230	53	18.64	61	72	26.09	32	80
14	±1%	1.3	181	99	15.13	215	53	20.80	55	71	30.61	28	79
15	±1%	1.2	169	93	16.28	200	52	22.95	48	70	35.13	24	78
16	±1%	1.2	164	90	17.51	195	51	26.01	46	69	46.51	22	76
17	±1%	1.2	159	88	18.75	189	50	29.07	43	67	57.90	19	75
18	±1%	1.1	154	85	19.98	183	49	32.14	41	66	69.29	17	73
19	±1%	1.1	150	82	21.21	178	49	36.34	39	66	n/a	n/a	n/a
20	±1%	1.1	145	80	22.43	172	49	40.55	38	65	n/a	n/a	n/a
22	±1%	1.0	136	75	24.88	162	49	48.96	34	64	n/a	n/a	n/a
24	±1%	1.0	126	70	27.34	151	48	57.38	31	63	n/a	n/a	n/a
27	±1%	0.9	112	62	31.02	135	48	70.00	26	62	n/a	n/a	n/a
30	±1%	0.9	101	56	36.14	121	48	n/a	n/a	n/a	n/a	n/a	n/a
33	±1%	0.8	90	50	41.27	108	48	n/a	n/a	n/a	n/a	n/a	n/a
36	±1%	0.8	79	44	46.39	95	48	n/a	n/a	n/a	n/a	n/a	n/a
39	±1%	0.8	68	38	51.52	82	48	n/a	n/a	n/a	n/a	n/a	n/a
43	±1%	0.7	54	30	58.35	64	48	n/a	n/a	n/a	n/a	n/a	n/a
47	±1%	0.7	39	21	65.18	46	48	n/a	n/a	n/a	n/a	n/a	n/a
82	±1%	0.7	17	10	148.400	24	48	n/a	n/a	n/a	n/a	n/a	n/a

Accu-P® 01005 Typical SRF vs Capacitance

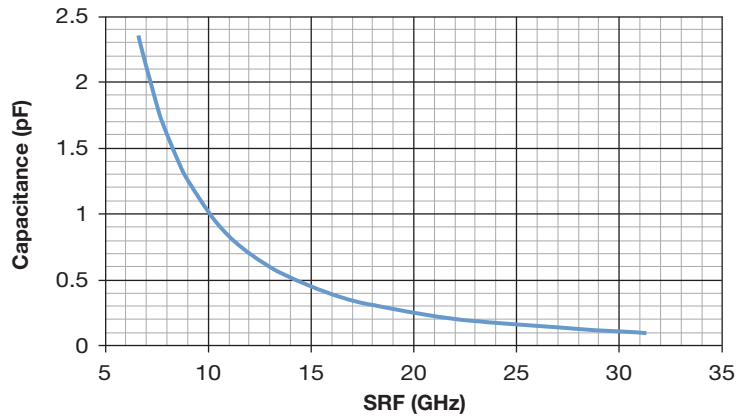

Measured on HP8720ES

Accu-P® 01005 Typical ESR vs Frequency

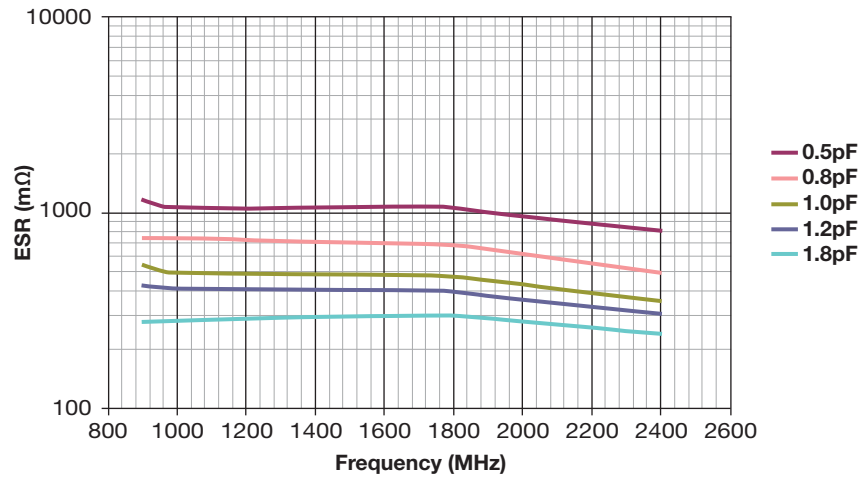

Measured on Agilent 4278A/4991A

Accu-P® 01005 Typical Q vs Frequency

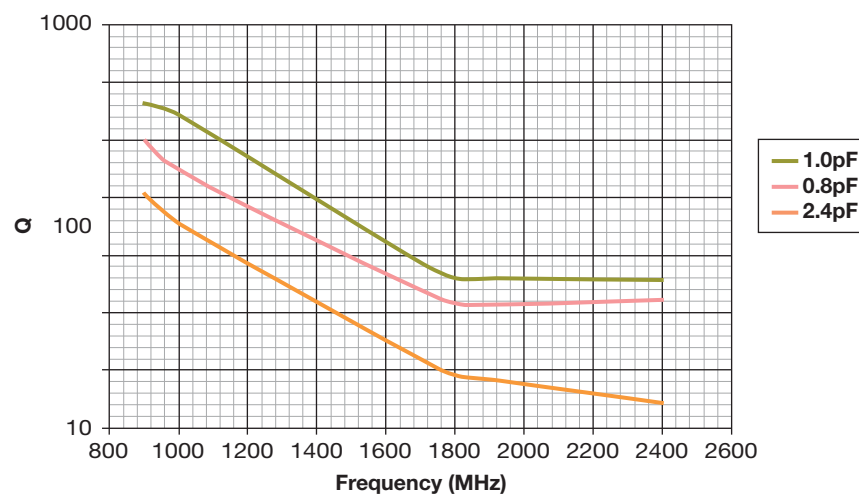

Measured on Agilent 4278A/4991A

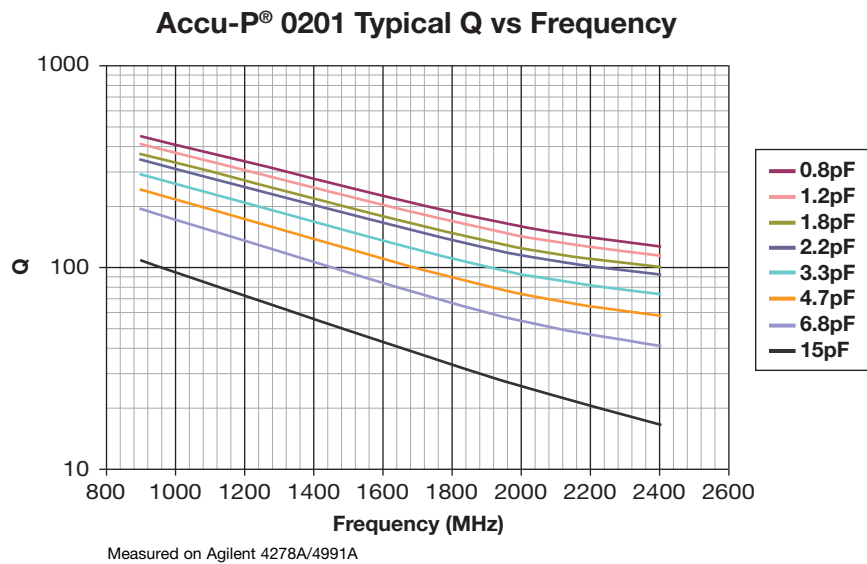
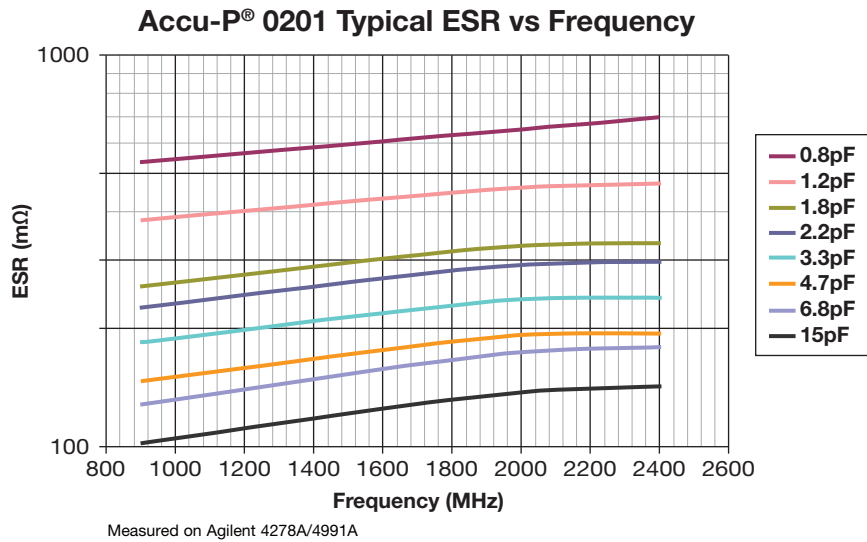
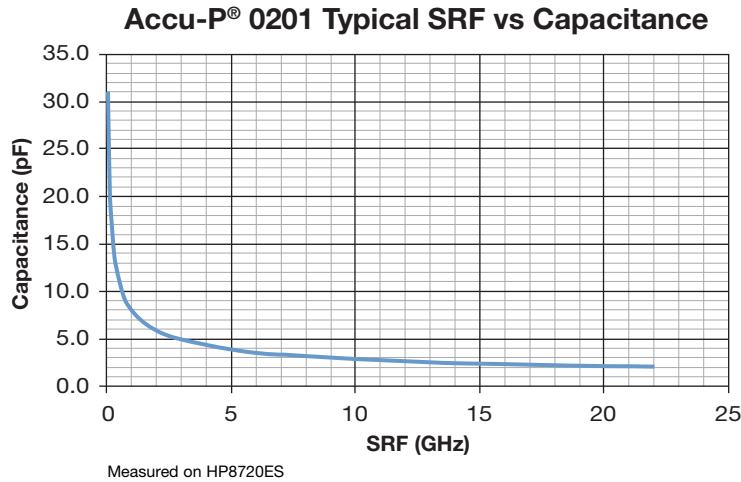

Accu-P® 0402 Typical SRF vs Capacitance

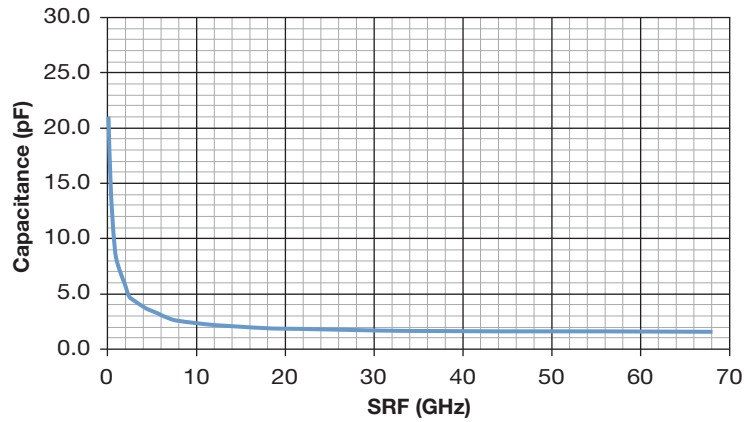

Measured on HP8720ES

Accu-P® 0402 Typical ESR vs Frequency

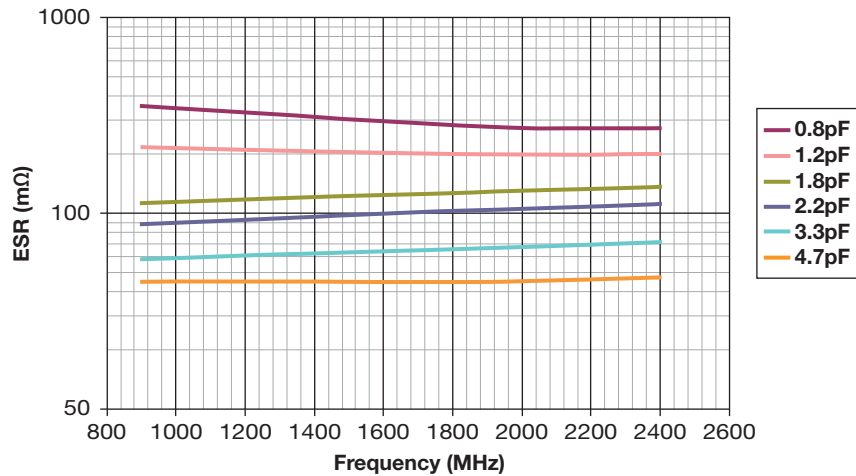

Measured on Agilent 4278A/4991A

Accu-P® 0402 Typical Q vs Frequency

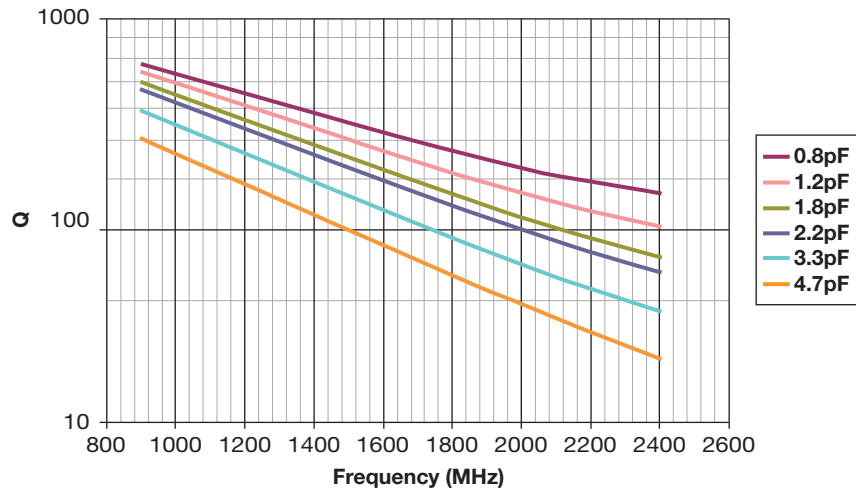

Measured on Agilent 4278A/4991A

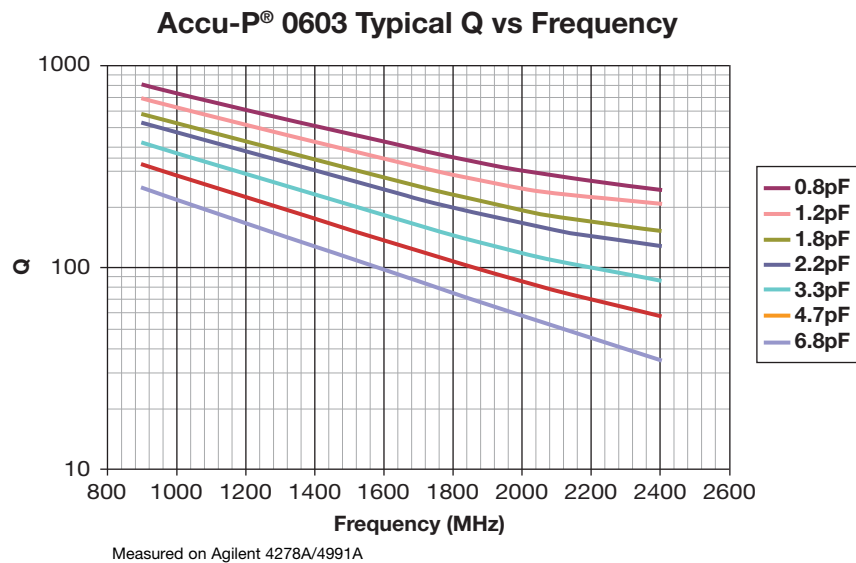
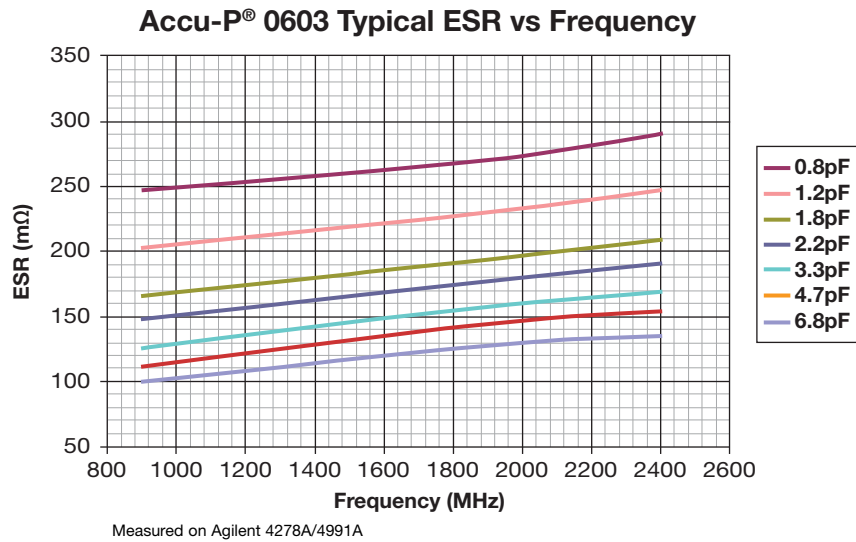
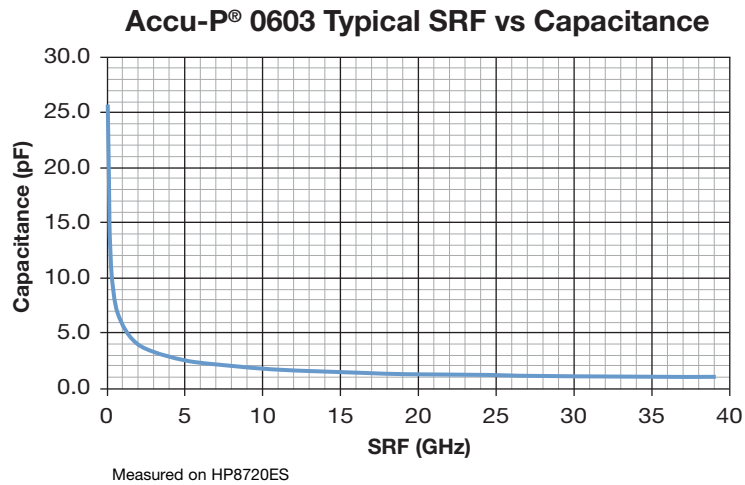

Accu-P® 0805 Typical SRF vs Capacitance

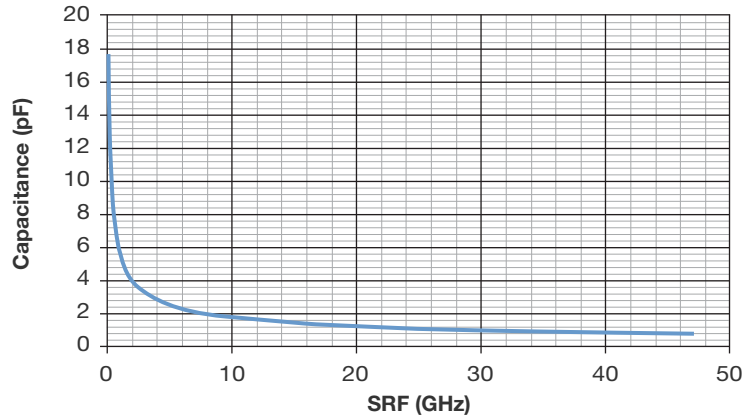

Measured on HP8720ES

Accu-P® 0805 Typical ESR vs Frequency

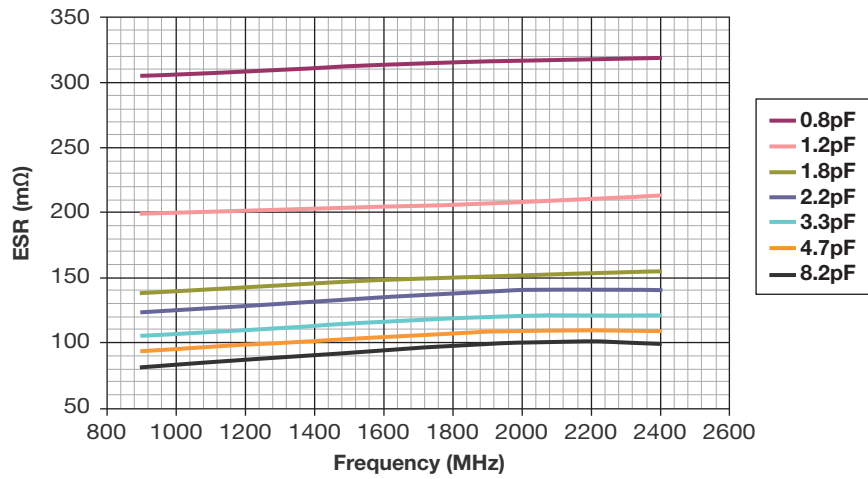

Measured on Agilent 4278A/4991A

Accu-P® 0805 Typical Q vs Frequency

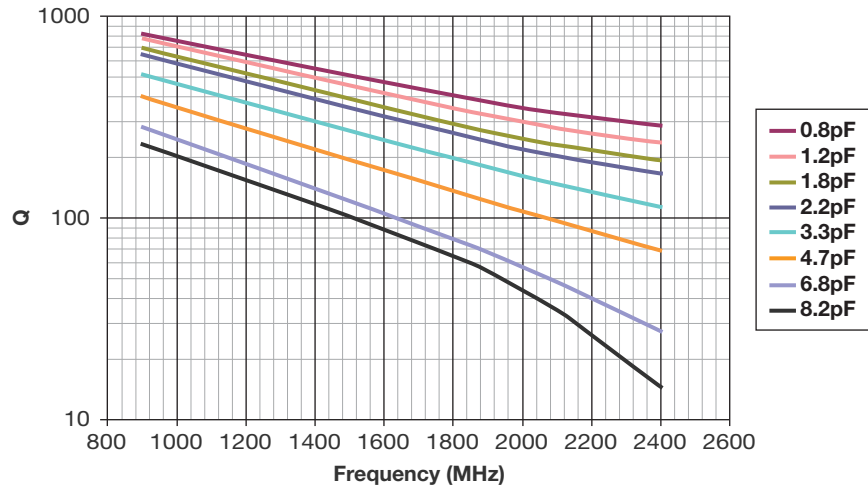

Measured on Agilent 4278A/4991A

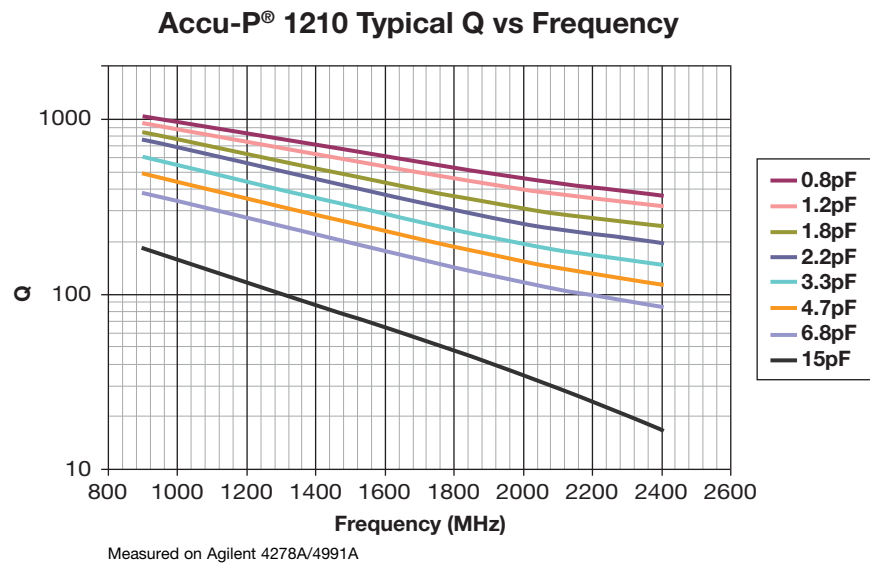
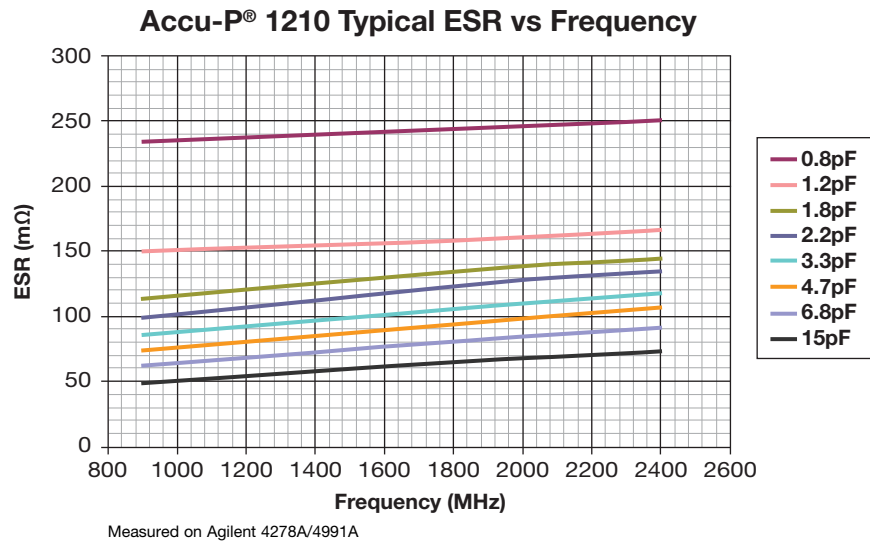
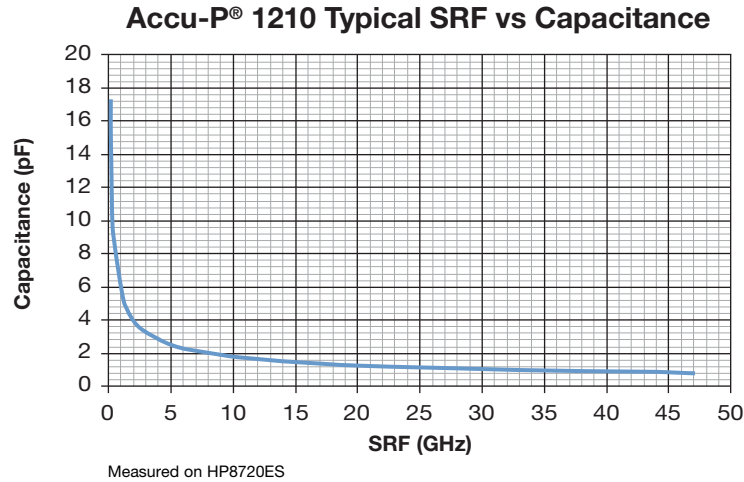

ENVIRONMENTAL CHARACTERISTICS

TEST	CONDITIONS	REQUIREMENT
Life (Endurance) MIL-STD-202F Method 108A	125°C, 2UR, 1000 hours	No visible damage $\Delta C/C \leq 2\%$ for $C \geq 5pF$ $\Delta C \leq 0.25pF$ for $C < 5pF$
Accelerated Damp Heat Steady State MIL-STD-202F Method 103B	85°C, 85% RH, UR, 1000 hours	No visible damage $\Delta C/C \leq 2\%$ for $C \geq 5pF$ $\Delta C \leq 0.25pF$ for $C < 5pF$
Temperature Cycling MIL-STD-202F Method 107E MIL-STD-883D Method 1010.7	-55°C to +125°C, 15 cycles – Accu-P®	No visible damage $\Delta C/C \leq 2\%$ for $C \geq 5pF$ $\Delta C \leq 0.25pF$ for $C < 5pF$
Resistance to Solder Heat IEC-68-2-58	260°C ± 5°C for 10 secs	C remains within initial limits

MECHANICAL CHARACTERISTICS

TEST	CONDITIONS	REQUIREMENT
Solderability IEC-68-2-58	Components completely immersed in a solder bath at 235°C for 2 secs.	Terminations to be well tinned, minimum 95% coverage
Leach Resistance IEC-68-2-58	Components completely immersed in a solder bath at 260±5°C for 60 secs.	Dissolution of termination faces ≤15% of area Dissolution of termination edges ≤25% of length
Adhesion MIL-STD-202F Method 211A	A force of 5N applied for 10 secs.	No visible damage
Termination Bond Strength IEC-68-2-21 Amend. 2	Tested as shown in diagram D = 3mm Accu-P D = 1mm Accu-F	No visible damage $\Delta C/C \leq 2\%$ for $C \geq 5pF$ $\Delta C \leq 0.25pF$ for $C < 5pF$
Robustness of Termination IEC-68-2-21 Amend. 2	A force of 5N applied for 10 secs.	No visible damage
High Frequency Vibration MIL-STD-202F Method 201A, 204D (Accu-P® only)	55Hz to 2000Hz, 20G	No visible damage
Storage	12 months minimum with components stored in "as received" packaging	Good solderability

QUALITY & RELIABILITY

Accu-P® is based on well established thin-film technology and materials.

• ON-LINE PROCESS CONTROL

This program forms an integral part of the production cycle and acts as a feedback system to regulate and control production processes. The test procedures, which are integrated into the production process, were developed after long research work and are based on the highly developed semiconductor industry test procedures and equipment. These measures help KYOCERA AVX to produce a consistent and high yield line of products.

• FINAL QUALITY INSPECTION

Finished parts are tested for standard electrical parameters and visual/mechanical characteristics. Each production lot is 100% evaluated for: capacitance and proof voltage at 2.5 UR. In addition, production is periodically evaluated for:

- Average capacitance with histogram printout for capacitance distribution;
- IR and Breakdown Voltage distribution;
- Temperature Coefficient;
- Solderability;
- Dimensional, mechanical and temperature stability.

QUALITY ASSURANCE

The reliability of these thin-film chip capacitors has been studied intensively for several years. Various measures have been taken to obtain the high reliability required today by the industry. Quality assurance policy is based on well established international industry standards. The reliability of the capacitors is determined by accelerated testing under the following conditions:

Life (Endurance)	125°C, 2UR, 1000 hours
Accelerated Damp Heat Steady State	85°C, 85% RH, UR, 1000 hours.

Accu-P® Series

Performance Characteristics RF Power Applications

RF POWER APPLICATIONS

In RF power applications capacitor losses generate heat. Two factors of particular importance to designers are:

- Minimizing the generation of heat.
- Dissipating heat as efficiently as possible.

CAPACITOR HEATING

- The major source of heat generation in a capacitor in RF power applications is a function of RF current (I) and ESR, from the relationship:
- Power dissipation = $I_{RMS}^2 \times ESR$
- Accu-P® capacitors are specially designed to minimize ESR and therefore RF heating. Values of ESR for Accu-P® capacitors are significantly less than those of ceramic MLC components currently available.

HEAT DISSIPATION

- Heat is dissipated from a capacitor through a variety of paths, but the key factor in the removal of heat is the thermal conductivity of the capacitor material.
- The higher the thermal conductivity of the capacitor, the more rapidly heat will be dissipated.
- The table below illustrates the importance of thermal conductivity to the performance of Accu-P® in power applications.

Data used in calculating the graph:

Thermal impedance of capacitors:

- 0402 17°C/W
- 0603 12°C/W
- 0805 6.5°C/W
- 1210 5°C/W

PRODUCT	MATERIAL	THERMAL CONDUCTIVITY W/mK
Accu-P® Microwave MLC	Alumina Magnesium Titanate	18.9 6.0

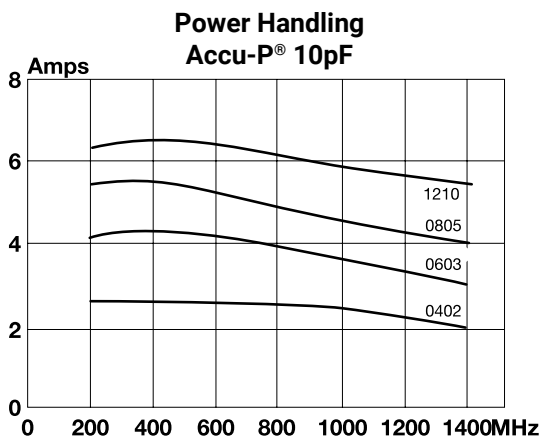

Thermal impedance measured using RF generator, amplifier and strip-line transformer. ESR of capacitors measured on Boonton 34A

THERMAL IMPEDANCE

Thermal impedance of Accu-P® chips is shown below compared with the thermal impedance of Microwave MLC's.

The thermal impedance expresses the temperature difference in °C between chip center and termination caused by a power dissipation of 1 watt in the chip. It is expressed in °C/W.

ADVANTAGES OF ACCU-P® IN RF POWER CIRCUITS

The optimized design of Accu-P® offers the designer of RF power circuits the following advantages:

- Reduced power losses due to the inherently low ESR of Accu-P®.
- Increased power dissipation due to the high thermal conductivity of Accu-P®.
- The only true test of a capacitor in any particular application is its performance under operating conditions in the actual circuit.

CAPACITOR TYPE	CHIP SIZE	THERMAL IMPEDANCE (°C/W)
Accu-P®	0805	6.5
	1210	5
Microwave MLC	0505	12
	1210	7.5

PRACTICAL APPLICATION IN RF POWER CIRCUITS

- There is a wide variety of different experimental methods for measuring the power handling performance of a capacitor in RF power circuits. Each method has its own problems and few of them exactly reproduce the conditions present in "real" circuit applications.
- Similarly, there is a very wide range of different circuit applications, all with their unique characteristics and operating conditions which cannot possibly be covered by such "theoretical" testing.

GENERAL

Accu-P® SMD capacitors are designed for soldering to printed circuit boards or other substrates. The construction of the components is such that they will withstand the time/temperature profiles used in both wave and reflow soldering methods.

CIRCUIT BOARD TYPE

The circuit board types which may be used with Accu-P® are as follows:

All flexible types of circuit boards
(eg. FR-4, G-10) and also alumina.

For other circuit board materials, please consult factory.

HANDLING

SMD capacitors should be handled with care to avoid damage or contamination from perspiration and skin oils. The use of plastic tipped tweezers or vacuum pick-ups is strongly recommended for individual components. Bulk handling should ensure that abrasion and mechanical shock are minimized. For automatic equipment, taped and reeled product gives the ideal medium for direct presentation to the placement machine.

COMPONENT PAD DESIGN

Component pads must be designed to achieve good joints and minimize component movement during reflow soldering. Pad designs are given below for both wave and reflow soldering.

The basis of these designs is:

- Pad width equal to component width. It is permissible to decrease this to as low as 85% of component width but it is not advisable to go below this.
- Pad overlap 0.5mm beneath large components. Pad overlap about 0.3mm beneath small components.
- Pad extension of 0.5mm for reflow of large components and pad extension about 0.3mm for reflow of small components. Pad extension about 1.0mm for wave soldering.

REFLOW SOLDERING PAD DIMENSIONS: millimeters (inches)

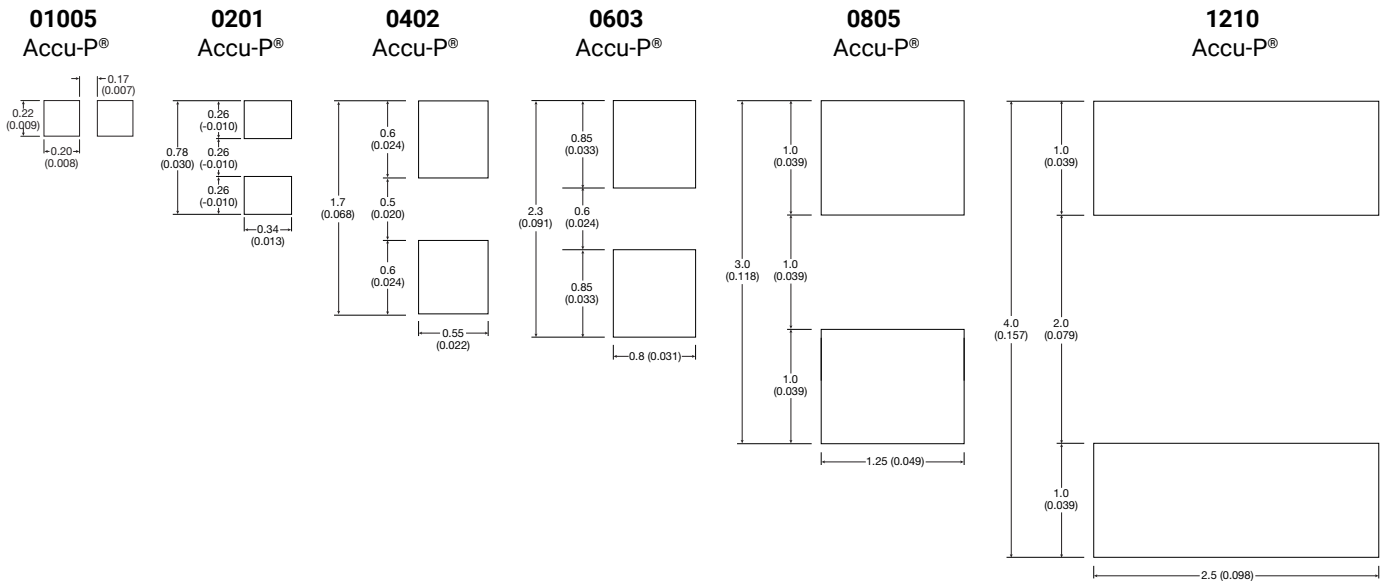

PREHEAT & SOLDERING

The rate of preheat in production should not exceed 4°C/ second and a recommended maximum is about 2°C/second. Temperature differential from preheat to soldering should not exceed 100°C.

For further specific application or process advice, please consult KYOCERA AVX.

COOLING

After soldering, the assembly should preferably be allowed to cool naturally. In the event of assisted cooling, similar conditions to those recommended for preheating should be used.

HAND SOLDERING & REWORK

Hand soldering is permissible. Preheat of the PCB to 150°C is required. The most preferable technique is to use hot air soldering tools. Where a soldering iron is used, a temperature controlled model not exceeding 30 watts should be used and set to not more than 260°C.

CLEANING RECOMMENDATIONS

Care should be taken to ensure that the devices are thoroughly cleaned of flux residues, especially the space beneath the device. Such residues may otherwise become conductive and effectively offer a lossy bypass to the device. Various recommended cleaning conditions (which must be optimized for the flux system being used) are as follows:

- Cleaning liquids i-propanol, ethanol, acetylacetone, water and other standard PCB cleaning liquids.
- Ultrasonic conditions power-20w/liter max. frequency-20kHz to 45kHz.
- Temperature 80°C maximum (if not otherwise limited by chosen solvent system).
- Time 5 minutes max.

STORAGE CONDITIONS

Recommended storage conditions for Accu-P® prior to use are as follows:

- Temperature 15°C to 35°C
- Humidity ≤65%
- Air Pressure 860mbar to 1060mbar

RECOMMENDED REFLOW SOLDERING PROFILE COMPONENTS WITH SNPB TERMINATIONS

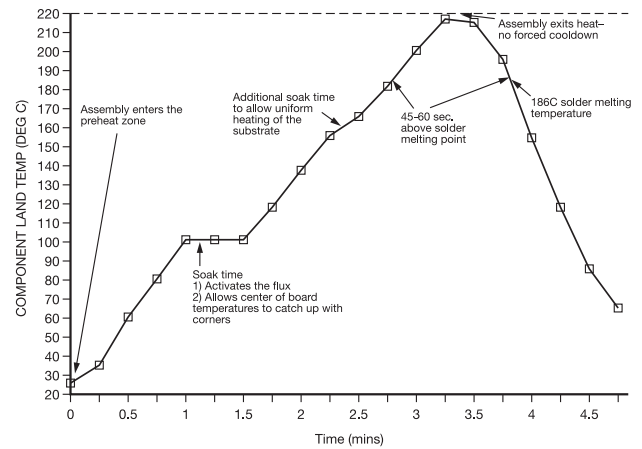

RECOMMENDED REFLOW SOLDERING PROFILE LEAD FREE COMPONENTS WITH SN100 TERMINATIONS

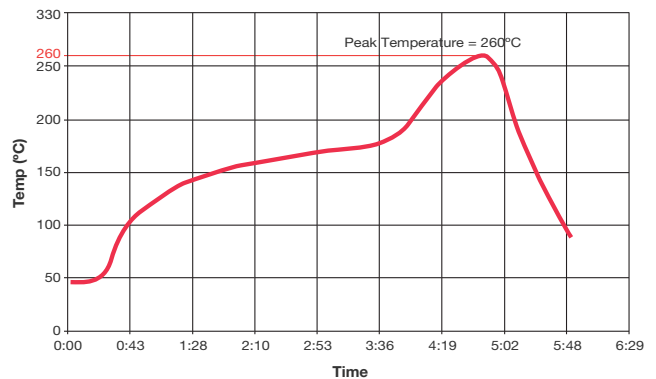

TAPE & REEL

All tape and reel specifications are in compliance with EIA 481-1-A. (equivalent to IEC 286 part 3).

- 8mm carrier
- Reeled quantities: Reels of 3,000 per 7" reel or 10,000 pieces per 13" reel
01005, 0201, and 0402 = 5,000 pieces per 7" reel and 20,000 pieces per 13" reel

REEL DIMENSIONS: millimeters (inches)

A(1)	B	C	D	E	F	G
180±1.0 (7.087±0.039)	1.5 min. (0.059 min.)	13±0.2 (0.512 ± 0.008)	20.2 min. (0.795 min.)	50 min. (1.969 min.)	9.6±1.5 (0.370 ± 0.050)	14.4 max. (0.567 max.)

Metric dimensions will govern.

Inch measurements rounded and for reference only.

(1) 330mm (13 inch) reels are available.

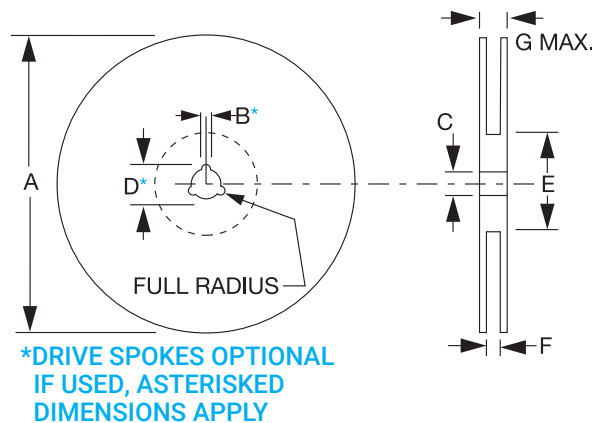

CARRIER DIMENSIONS: millimeters (inches)

A	B	C	D	E	F
8.0 ± 0.3 (0.315 ± 0.012)	3.5 ± 0.05 (0.138 ± 0.002)	1.75 ± 0.1 (0.069 ± 0.004)	2.0 ± 0.05 (0.079 ± 0.002)	4.0 ± 0.1 (0.157 ± 0.004)	1.5 ^{+0.1} _{-0.0} (0.059 ^{+0.004} _{-0.000})

The nominal dimensions of the component compartment (W,L) are derived from the component size.

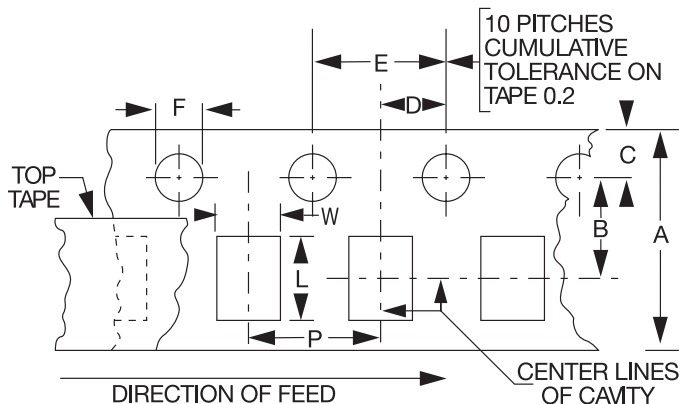

P = 4mm for 0603, 0805, 1210

P = 2mm for 01005, 0201, and 0402

Thin-Film RF/Microwave Capacitor Technology

Accu-P® Series

Ultra-Miniature 01005 Size



ACCU-P® TECHNOLOGY

The use of silicon oxide, a very low - loss dielectric material, in conjunction with highly conductive electrode metals, results in low ESR and high Q. These high - frequency characteristics change at a slower rate with increasing frequency than for ceramic microwave capacitors.

ACCU-P® meets the fast - growing demand for low - loss (high - Q) capacitors for use in surface mount technology, especially for the wireless communications market at frequencies up to and above 5.8GHz.

ACCU-P® is currently unique in its ability to offer very low capacitance values (0.05 pF) and ultra tight capacitance tolerances (± 0.01 pF).

ACCU-P® TECHNOLOGY

- RF Modules
- Mobile communications
- Stalite TV
- Global positioning systems
- Filters
- VCO's
- Matching Networks

FEATURES

- Ultra Miniature standard 01005 chip size.
- Ultra tight capacitance tolerances (± 0.01 pF).
- Low ESR and high Q at VHF, UHF and microwave frequencies.
- TC ± 30 , ± 60 ppm/ $^{\circ}$ C.
- Nickel/Solder - coated terminations provide excellent solderability and leach resistance.
- High insulation resistance: IR ≥ 1010 Ohm.
- Orientation provides high SRF uniformity.
- Repeatable CEFF, ESR and Q vs. Frequency parameters, both lot to lot and within lots, for increased production yields.

HOW TO ORDER

C005	Y	X	XXX	X	B	S	TR
Series	Voltage Y = 16V	Temperature Coefficient	Capacitance (pF)	Tolerance	Accu-P	Lead Free Termination	Packaging Code 500 pc Reel TR/10K = 10,000 pc reel TR/20K = 20,000 pc reel

P/N Example: C 0 0 5 Y K 1 R 0 A B S T R

ACCU-P® TECHNOLOGY

Finished parts are tested for standard electrical parameters and visual / mechanical characteristics.

Each production lot is 100% evaluated for:

- Capacitance
- Q Factor
- DWV at $12.5 \times V_{RATED}$

Each production lot is evaluated on a sample basis for:

- Dimensions
- Insulation Resistance
- Breakdown Voltage
- ESR
- Solderability

In addition, production is periodically evaluated for:

- Dimensions
- Insulation Resistance
- Breakdown Voltage
- ESR
- Solderability

ACCU-P® 01005 CAPACITANCE RANGE

Capacitance [pF]	Part Number	Tolerances Z = ±0.01pF P = ±0.02pF Q = ±0.03pF A = ±0.05pF	TC J = ±30ppm/°C K = ±60pFppm/°C	Voltage (V)
0.05	C005YJR05_BSTR	Z, P, Q, A	J	16
0.10	C005YJ0R1_BSTR	Z, P, Q, A	J	16
0.15	C005YJR15_BSTR	Z, P, Q, A	J	16
0.20	C005YJ0R2_BSTR	Z, P, Q, A	J	16
0.25	C005YJR25_BSTR	Z, P, Q, A	J	16
0.30	C005YJ0R3_BSTR	Z, P, Q, A	J	16
0.35	C005YJR35_BSTR	Z, P, Q, A	J	16
0.40	C005YJ0R4_BSTR	Z, P, Q, A	J	16
0.45	C005YJR45_BSTR	Z, P, Q, A	J	16
0.50	C005YJ0R5_BSTR	Z, P, Q, A	J	16
0.55	C005YJR55_BSTR	P, Q, A	J	16
0.60	C005YJ0R6_BSTR	P, Q, A	J	16
0.65	C005YJR65_BSTR	P, Q, A	J	16
0.70	C005YJ0R7_BSTR	P, Q, A	J	16
0.75	C005YJR75_BSTR	P, Q, A	K	16
0.80	C005YK0R8_BSTR	P, Q, A	K	16
0.85	C005YKR85_BSTR	P, Q, A	K	16

Capacitance [pF]	Part Number	Tolerances Z = ±0.01pF P = ±0.02pF Q = ±0.03pF A = ±0.05pF	TC J = ±30ppm/°C K = ±60pFppm/°C	Voltage (V)
0.90	C005YK0R9_BSTR	P, Q, A	K	16
0.95	C005YKR95_BSTR	P, Q, A	K	16
1.00	C005YK1R0_BSTR	P, Q, A	K	16
1.10	C005YK1R1_BSTR	P, Q, A	K	16
1.20	C005YK1R2_BSTR	P, Q, A	K	16
1.30	C005YK1R3_BSTR	P, Q, A	K	16
1.40	C005YK1R4_BSTR	P, Q, A	K	16
1.50	C005YK1R5_BSTR	P, Q, A	K	16
1.60	C005YK1R6_BSTR	P, Q, A	K	16
1.70	C005YK1R7_BSTR	P, Q, A	K	16
1.80	C005YK1R8_BSTR	P, Q, A	K	16
1.90	C005YK1R9_BSTR	P, Q, A	K	16
2.00	C005YK2R0_BSTR	P, Q, A	K	16
2.10	C005YK2R1_BSTR	P, Q, A	K	16
2.20	C005YK2R2_BSTR	P, Q, A	K	16
2.30	C005YK2R3_BSTR	P, Q, A	K	16
2.40	C005YK2R4_BSTR	P, Q, A	K	16

Intermediate capacitance values are available

DIMENSIONS: mm (inches)

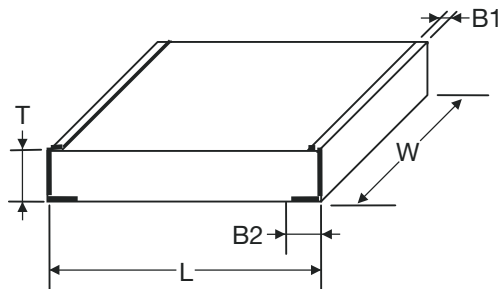

L	0.405 ± 0.020 (0.016 ± 0.001)
W	0.215 ± 0.020 (0.0085 ± 0.001)
T	0.145 ± 0.020 (0.006 ± 0.001)
B	Top (B1): 0.0 +0.10/-0.0 (0.0 +0.004/-0.0)
	Bottom (B2): 0.10 ± 0.03 (0.004 ± 0.001)

RECOMMENDED PAD LAYOUT: mm (inches)

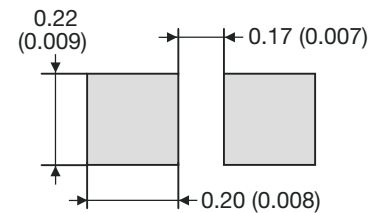

PACKAGING SPECIFICATION: mm (inches)

Standard Packaging: 5,000 / 10,000 / 20,000pcs in 4" / 7" reels

Materials: Reel – Polystyrene

Tape – Paper: 8.00 (0.315)

Component pitch: 2.00 (0.079)

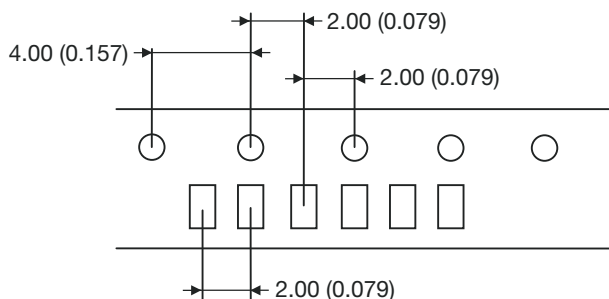



Thin-Film RF/Microwave Capacitor Technology

Accu-L[®] Series

Thin-Film RF/Microwave Inductor Technology

Accu-L® Series

L0201 Tight Tolerance RF Inductor



ACCU-L® TECHNOLOGY

The L0201 SMD Tuning Inductor is based on thin-film multilayer technology. The technology provides a miniature part with excellent high frequency performance and rugged construction for reliable automatic assembly.

APPLICATIONS

- Mobile Communications
- Satellite TV Receivers
- GPS
- Vehicle Location Systems
- Wireless LAN's
- Filters
- Matching Networks

HOW TO ORDER



P/N Example: **L02013R3BHSTR**

Finished parts are 100% tested for electrical parameters and visual characteristics. Each production lot is evaluated on a sample basis for:

- Static Humidity: 85°C, 85% RH, 160 hours
- Endurance: 125°C, IR, 4 hours

TERMINATION

Nickel/Lead Free solder coating compatible with automatic soldering technologies: reflow, wave soldering, vapor phase and manual.

DIMENSIONS: millimeters (inches) (TOP View)

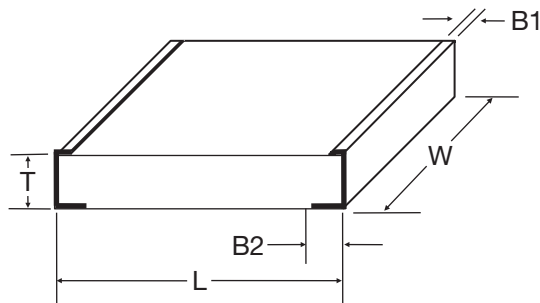

L	0.600±0.050 (0.024±0.002)
W	0.325±0.050 (0.013±0.002)
T	0.225±0.050 (0.009±0.002)

B1	0.100±0.100 (0.004±0.004)
B2	0.150±0.050 (0.006±0.002)

Recommended Pad Layout Dimensions mm (inches)

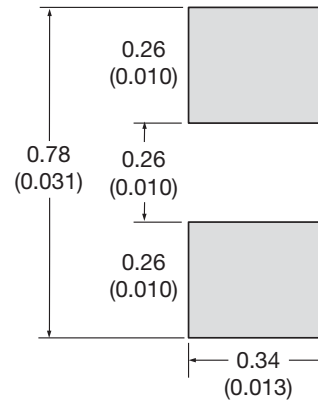

Thin-Film RF/Microwave Inductor Technology

Accu-L® Series

L0201 Tight Tolerance RF Inductor



ELECTRICAL SPECIFICATIONS

L(nH)	450MHz		900MHz	1900MHz	2400MHz	SRF min. (GHz)	R _{DC} max. (Ω)	I _{DC} max. (mA)
	Tolerance A=±0.05nH, B=±0.1nH, C=±0.2nH, D=±0.5nH	Q (min)	Q (Typ)	Q (Typ)	Q (Typ)			
0.33	±0.05nH, ± 0.1nH, ± 0.2nH	13	24	36	39	35	0.1	550
0.39	±0.05nH, ± 0.1nH, ± 0.2nH	11	23	34	38	33	0.1	550
0.47	±0.05nH, ± 0.1nH, ± 0.2nH	10	18	26	30	32	0.1	550
0.56	±0.05nH, ± 0.1nH, ± 0.2nH	9	16	24	27	31	0.1	500
0.68	±0.05nH, ± 0.1nH, ± 0.2nH	8	19	28	32	30	0.2	500
0.82	±0.05nH, ± 0.1nH, ± 0.2nH	8	19	28	32	28	0.2	400
1.0	±0.05nH, ± 0.1nH, ± 0.2nH	7	16	26	30	26	0.2	400
1.2	±0.05nH, ± 0.1nH, ± 0.2nH	7	16	26	30	24	0.3	300
1.5	± 0.1nH, ± 0.2nH, ± 0.5nH	7	16	26	30	23	0.5	250
1.8	± 0.1nH, ± 0.2nH, ± 0.5nH	7	15	25	29	20	0.5	250
2.2	± 0.1nH, ± 0.2nH, ± 0.5nH	7	15	22	24	18	0.6	200
2.7	± 0.1nH, ± 0.2nH, ± 0.5nH	7	15	22	24	14	0.7	180
3.3	± 0.1nH, ± 0.2nH, ± 0.5nH	7	15	22	24	13	1.0	150

All intermediate Inductance values within the indicated range are available.

Thin-Film RF/Microwave Inductor Technology

Accu-L® Series

L0402 Tight Tolerance RF Inductor



GENERAL DESCRIPTION ITF TECHNOLOGY

The L0402 LGA Inductor is based on thin-film multilayer technology. The technology provides a miniature part with excellent high frequency performance and rugged construction for reliable automatic assembly.

APPLICATIONS

- Mobile Communications
- Satellite TV Receivers
- GPS
- Vehicle Location Systems
- Wireless LAN's
- Filters
- Matching Networks

LAND GRID ARRAY ADVANTAGES

- Inherent Low Profile
- Self Alignment during Reflow
- Excellent Solderability
- Low Parasitics
- Better Heat Dissipation

DIMENSIONS: millimeters (inches) (BOTTOM VIEW)

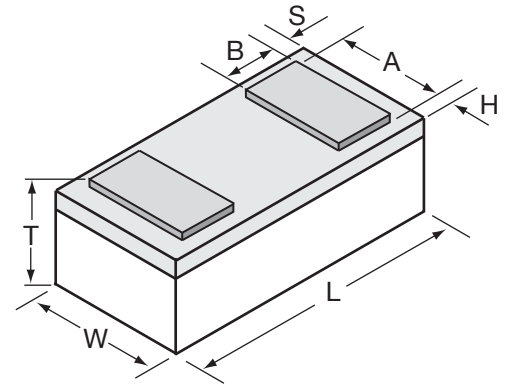

L	1.00±0.10 (0.039±0.004)
W	0.58±0.07 (0.023±0.003)
T	0.35±0.10 (0.014±0.004)

A	0.48±0.05 (0.019±0.002)
B	0.17±0.05 (0.007±0.002)
S, H	0.064±0.05 (0.003±0.002)

HOW TO ORDER



P/N Example: **L04023R3BHNR**



QUALITY INSPECTION

Finished parts are 100% tested for electrical parameters and visual characteristics. Each production lot is evaluated on a sample basis for:

- Static Humidity: 85°C, 85% RH, 160 hours
- Endurance: 125°C, IR, 4 hours

TERMINATION

Nickel/Lead Free solder coating compatible with automatic soldering

technologies: reflow, wave soldering, vapor phase and manual.

MAKING AND ORIENTATION IN TAPE

(Top View)

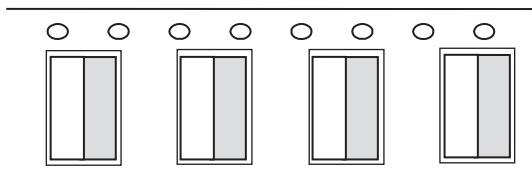

Recommended Pad Layout Dimensions

mm (inches)

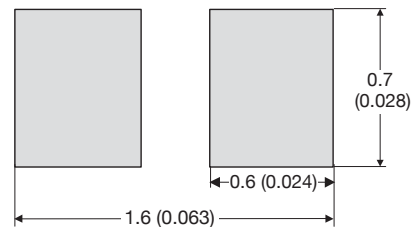

Thin-Film RF/Microwave Inductor Technology

Accu-L® Series

L0402 Tight Tolerance RF Inductor



ELECTRICAL SPECIFICATIONS

L(nH)	Tolerance A=±0.05nH, B=±0.1nH, C=±0.2nH, D=±0.5nH	Q (min)	Q (Typ)	450MHz	900MHz	1900MHz	2400MHz	SRF min. (MHz)	R _{dc} max. (Ω)	I _{dc} max. (mA)
				Q (Typ)	Q (Typ)	Q (Typ)	Q (Typ)			
0.56	± 0.05nH, ± 0.1nH	35	45	55	65	75	20000	0.02	1000	
0.68	± 0.05nH, ± 0.1nH	30	40	50	60	70	20000	0.04	750	
0.82	± 0.05nH, ± 0.1nH	25	40	50	60	70	20000	0.06	500	
1.0	± 0.05nH, ± 0.1nH	20	30	35	40	50	20000	0.15	500	
1.2	± 0.05nH, ± 0.1nH, ± 0.2nH	20	30	30	40	45	20000	0.20	400	
1.5	± 0.05nH, ± 0.1nH, ± 0.2nH	20	25	30	40	40	18000	0.20	400	
1.8	± 0.05nH, ± 0.1nH, ± 0.2nH	18	20	30	35	40	16000	0.20	400	
2.2	± 0.05nH, ± 0.1nH, ± 0.2nH	15	20	25	35	40	15000	0.20	400	
2.7	± 0.05nH, ± 0.1nH, ± 0.2nH	15	20	25	35	40	9500	0.25	250	
3.3	± 0.1nH, ± 0.2nH, ± 0.5nH	15	20	25	35	40	8500	0.40	250	
3.9	± 0.1nH, ± 0.2nH, ± 0.5nH	13	20	20	30	30	8000	0.45	250	
4.7	± 0.1nH, ± 0.2nH, ± 0.5nH	13	20	20	30	30	7500	0.45	250	
5.6	± 0.1nH, ± 0.2nH, ± 0.5nH	13	20	20	30	30	7000	0.65	200	
6.8	± 0.1nH, ± 0.2nH, ± 0.5nH	12	15	20	25	30	6500	0.90	200	

Please contact factory for intermediate inductance values within the indicated range.

Thin-Film RF/Microwave Inductor Technology

Accu-L® Series

AEC-Q200 High-Q RF Inductor - L0402 & L0805



ACCU-L® TECHNOLOGY

The L0402 LGA Inductor and the L0805 Accu-L® SMD Inductor are based on thin-film multilayer technology. This technology provides a level of control on the electrical and physical characteristics of the component which gives consistent characteristics within a lot and lot-to-lot. The original design provides small size, excellent high-frequency performance and rugged construction for reliable automatic assembly.

The AEC-Q200 Qualified Accu-L® Series is designed to meet the demanding performance specifications in automotive signal and power applications.

FEATURES

- High Q
- RF Power Capability
- High SRF
- Low DC Resistance
- Ultra-Tight Inductance Tolerance
- Standard 0402 and 0805 Chip Sizes
- Low Profile
- Rugged Construction
- Taped and Reeled
- Operating/Storage Temp. Range: -55°C to +125°C

APPLICATIONS

- Vehicle to Vehicle Communications
- Infotainment
- Telematics
- GPS
- Radar
- Vehicle Locations Systems
- Keyless Entry
- Filters
- Matching Networks

0402 DIMENSIONS: millimeters (inches)
(Bottom View)

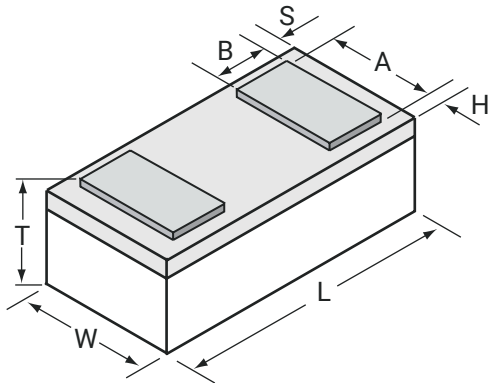

L	1.00±0.10 (0.039±0.004)
W	0.58±0.07 (0.023±0.003)
T	0.35±0.10 (0.014±0.004)
A	0.48±0.05 (0.019±0.002)
B	0.17±0.05 (0.007±0.002)
S, H	0.064±0.05 (0.003±0.002)

0805 DIMENSIONS: millimeters (inches)

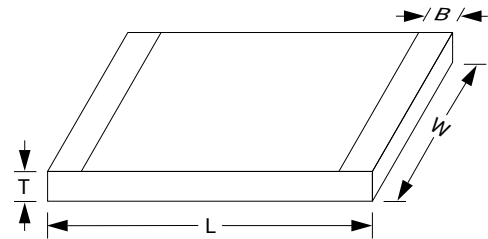

L	2.11±0.10 (0.083±0.004)
W	1.5±0.10 (0.059±0.004)
T	.91±0.13 (0.036±0.005)
B	0.25±0.15 (0.010±0.006)

Thin-Film RF/Microwave Inductor Technology



Accu-L® Series

AEC-Q200 High-Q RF Inductor - L0402 & L0805

HOW TO ORDER

L ↓	0805 ↓	4R7 ↓	D ↓	4 ↓	S ↓	TR ↓
Product Inductor	Size 0402 0805	Inductance Expressed in nH (2 significant digits + number of zeros) for values <10nH, letter R denotes decimal point. Example: 22nH = 220 4.7nH = 4R7	Tolerance A = ±0.05nH B = ±0.1nH C = ±0.2nH D = ±0.5nH G = ±2% J = ±5%	Specification Code 4 = AEC-Q200 Qualified Accu-L®	Termination Code S = Nickel/ Sn100 Lead Free Solder coated (L0805) N=Nickel/ Sn100 Lead Free Solder coated (L0402)	Packaging Code TR = Tape & Reel



ELECTRICAL SPECIFICATIONS TABLE FOR ACCU-L® 0402

L(nH)	450MHz		Q (min)	Q (Typ)	900MHz	1900MHz	2400MHz	SRF min (MHz)	R _{DC} max. (Ω)	I _{DC} max. (mA)
	Tolerance A=±0.05nH, B=±0.1nH, C=±0.2nH, D=±0.5nH	Q (Typ)			(Typ)	(Typ)	(Typ)			
0.56	± 0.05nH, ± 0.1nH	35	45	55	65	75	20000	0.02	1000	
0.68	± 0.05nH, ± 0.1nH	30	40	50	60	70	20000	0.04	750	
0.82	± 0.05nH, ± 0.1nH	25	40	50	60	70	20000	0.06	500	
1.0	± 0.05nH, ± 0.1nH	20	30	35	40	50	20000	0.15	500	
1.2	± 0.05nH, ± 0.1nH, ± 0.2nH	20	30	30	40	45	20000	0.20	400	
1.5	± 0.05nH, ± 0.1nH, ± 0.2nH	20	25	30	40	40	18000	0.20	400	
1.8	± 0.05nH, ± 0.1nH, ± 0.2nH	18	20	30	35	40	16000	0.20	400	
2.2	± 0.05nH, ± 0.1nH, ± 0.2nH	15	20	25	35	40	15000	0.20	400	
2.7	± 0.05nH, ± 0.1nH, ± 0.2nH	15	20	25	35	40	9500	0.25	250	
3.3	± 0.1nH, ± 0.2nH, ± 0.5nH	15	20	25	35	40	8500	0.40	250	
3.9	± 0.1nH, ± 0.2nH, ± 0.5nH	13	20	20	30	30	8000	0.45	250	
4.7	± 0.1nH, ± 0.2nH, ± 0.5nH	13	20	20	30	30	7500	0.45	250	
5.6	± 0.1nH, ± 0.2nH, ± 0.5nH	13	20	20	30	30	7000	0.65	200	
6.8	± 0.1nH, ± 0.2nH, ± 0.5nH	12	15	20	25	30	6500	0.90	200	

Please contact factory for intermediate inductance values within the indicated range.

ELECTRICAL SPECIFICATIONS TABLE FOR ACCU-L® 0805

Inductance L(nH)	450MHz Test Frequency		900MHz Test Frequency		1900MHz Test Frequency		2400MHz Test Frequency		SRF min (MHz)	R _{DC} max. (Ω)	I _{DC} max. (mA)	
	Available Inductance Tolerance	Q Typical	L (nH)	Q Typical	L (nH)	Q (Typ)	L (nH)	Q (Typ)			ΔT = 15°C (1)	ΔT = 70°C (2)
1.2	±0.1nH, ±0.2nH, ±0.5nH	60	1.2	92	1.2	122	1.2	92	10000	0.05	1000	2000
1.5	±0.1nH, ±0.2nH, ±0.5nH	50	1.5	74	1.5	102	1.5	84	10000	0.05	1000	2000
1.8	±0.1nH, ±0.2nH, ±0.5nH	50	1.8	72	1.8	88	1.9	73	10000	0.06	1000	2000
2.2	±0.1nH, ±0.2nH, ±0.5nH	42	2.2	62	2.2	82	2.3	72	10000	0.07	1000	2000
2.7	±0.1nH, ±0.2nH, ±0.5nH	42	2.7	62	2.8	80	2.9	70	10000	0.08	1000	2000
3.3	±0.1nH, ±0.2nH, ±0.5nH	38	3.3	46	3.4	48	3.5	57	10000	0.11	750	1500
3.9	±0.1nH, ±0.2nH, ±0.5nH	27	3.9	36	4.0	38	4.1	42	10000	0.20	750	1500
4.7	±0.1nH, ±0.2nH, ±0.5nH	43	4.8	62	5.3	76	5.8	60	5500	0.10	750	1500
5.6	±0.5nH	50	5.7	68	6.3	73	7.6	62	4600	0.10	750	1500
6.8	±0.5nH	43	7.0	62	7.7	71	9.4	50	4500	0.11	750	1500
8.2	±0.5nH	43	8.5	56	10.0	55	15.2	32	3500	0.12	750	1500
10	±2%, ±5%	46	10.6	60	13.4	52	-	-	2500	0.13	750	1500
12	±2%, ±5%	40	12.9	50	17.3	40	-	-	2400	0.20	750	1500
15	±2%, ±5%	36	16.7	46	27	23	-	-	2200	0.20	750	1000
18	±2%, ±5%	30	21.9	27	-	-	-	-	1700	0.35	500	1000
22	±2%, ±5%	36	27.5	33	-	-	-	-	1400	0.40	500	1000

(1) I_{DC} measured for 15°C rise at 25°C ambient temperature
 (2) I_{DC} measured for 70°C rise at 25°C ambient temperature

L, Q, SRF measured on HP 4291A, Boonton 34A and Wiltron 360 Vector Analyzer, RDC measured on Keithley 580 micro-ohmmeter.



The Important Information/Disclaimer is incorporated in the catalog where these specifications came from or available online at www.kyocera-avx.com/disclaimer/ by reference and should be reviewed in full before placing any order.

**Typical Q vs. Frequency
L0805**

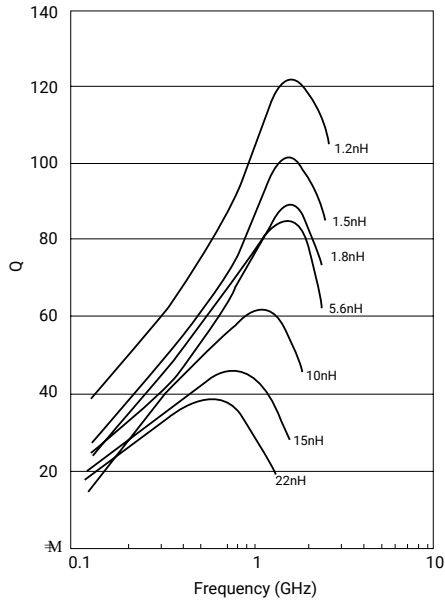

Measured on HP4291A and
Boonton 34A Coaxial Line

**Typical Inductance vs. Frequency
L0805**

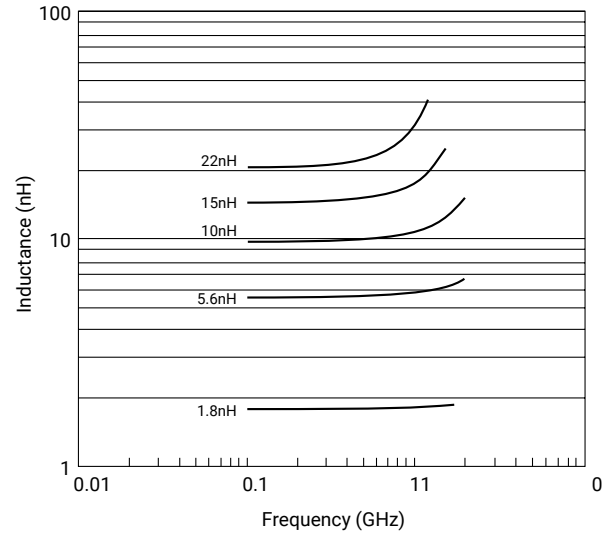

Measured on HP4291A and
Wiltron 360 Vector Analyzer

**Maximum Temperature Rise
at 25°C ambient temperature (on FR-4)
L0805**

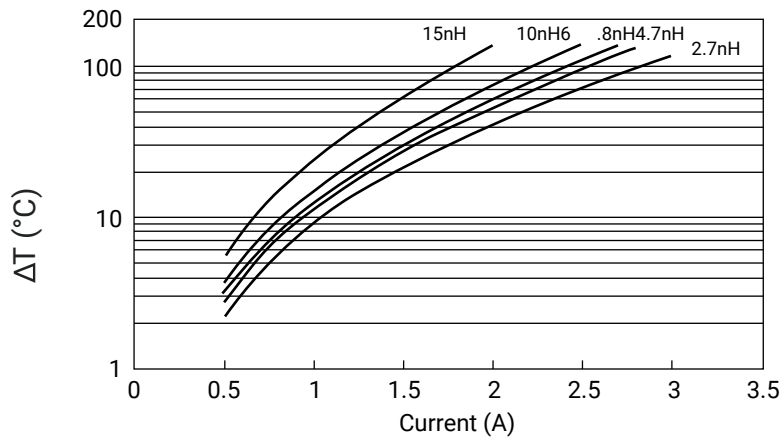

Temperature rise will typically be no higher than shown by the graph

Accu-L® Series

AEC-Q200 High-Q RF Inductor - L0402 & L0805

FINAL QUALITY INSPECTION

Finished parts are tested for electrical parameters and visual/mechanical characteristics.

Parts are 100% tested for inductance at 450MHz. Parts are 100% tested for RDC. Each production lot is evaluated on a sample basis for:

- Q at test frequency
- Static Humidity Resistance: 85°C, 85% RH, 160 hours
- Endurance: 125°C, IR, 4 hours

ENVIRONMENTAL CHARACTERISTICS

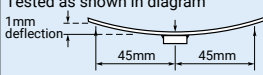
Test	Conditions	Requirement
Solderability	Components completely immersed in a solder bath at 235 ± 5°C for 2 secs.	Terminations to be well tinned. No visible damage.
Leach Resistance	Components completely immersed in a solder bath at 260 ± 5°C for 60 secs.	Dissolution of termination faces ≤ 15% of area. Dissolution of termination edges ≤ 25% of length.
Storage	12 months minimum with components stored in "as received" packaging.	Good solderability
Shear	Components mounted to a substrate. A force of 5N applied normal to the line joining the terminations and in a line parallel to the substrate.	No visible damage
Rapid Change of Temperature	Components mounted to a substrate. 5 cycles -55°C to +125°C.	No visible damage
Bend Strength	Tested as shown in diagram 	No visible damage
Temperature Coefficient of Inductance (TCL)	Component placed in environmental chamber -55°C to +125°C.	+0 to +125 ppm/°C (typical) $TCL = \frac{L_2 - L_1}{L_1 (T_2 - T_1)} \cdot 10^6$ $T_1 = 25^\circ\text{C}$

HANDLING

SMD chips should be handled with care to avoid damage or contamination from perspiration and skin oils. The use of plastic tipped tweezers or vacuum pick-ups is strongly recommended for individual components. Bulk handling should ensure that abrasion and mechanical shock are minimized. For automatic equipment, taped and reeled product is the ideal medium for direct presentation to the placement machine.

CIRCUIT BOARD TYPE

All flexible types of circuit boards may be used (e.g. FR-4, G-10) and also alumina.

For other circuit board materials, please consult factory

COMPONENT PAD DESIGN

Component pads must be designed to achieve good joints and minimize component movement during soldering. Pad designs are given below for both wave and reflow soldering.

The basis of these designs is:

- Pad width equal to component width. It is permissible to decrease this to as low as 85% of component width but it is not advisable to go below this.
- Pad overlap about 0.3mm.
- Pad extension about 0.3mm for reflow.
Pad extension about 0.8mm for wave soldering.

REFLOW SOLDERING DIMENSIONS: millimeter (inches)

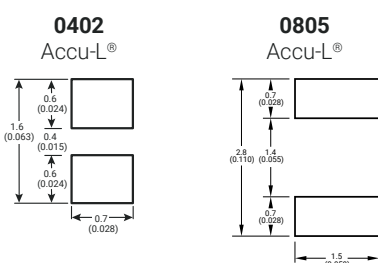

PREHEAT & SOLDERING

The rate of preheat in production should not exceed 4°C/second. It is recommended not to exceed 2°C/second.

Temperature differential from preheat to soldering should not exceed 150°C.

For further specific application or process advice, please consult KYOCERA AVX.

HAND SOLDERING & REWORK

Hand soldering is permissible. Preheat of the PCB to 100°C is required. The most preferable technique is to use hot air soldering tools. Where a soldering iron is used, a temperature controlled model not exceeding 30 watts should be used and set to not more than 260°C. Maximum allowed time at temperature is 1 minute. When hand soldering, the base side (white side) must be soldered to the board.

COOLING

After soldering, the assembly should preferably be allowed to cool naturally. In the event of assisted cooling, similar conditions to those recommended for preheating should be used.

CLEANING RECOMMENDATIONS

Care should be taken to ensure that the devices are thoroughly cleaned of flux residues, especially the space beneath the device. Such residues may otherwise become conductive and effectively offer a lossy bypass to the device. Various recommended cleaning conditions (which must be optimized for the flux system being used) are as follows:

Cleaning liquids..... i-propanol, ethanol, acetylacetone, water, and other standard PCB cleaning liquids.

Ultrasonic conditions... power – 20w/liter max.
frequency – 20kHz to 45kHz.

Temperature..... 80°C maximum (if not otherwise limited by chosen solvent system).

Time..... 5 minutes max

STORAGE CONDITIONS

Recommended storage conditions for Accu-L® prior to use are as follows:

Temperature..... 15°C to 35°C

Humidity ≤65%

Air Pressure..... 860mbar to 1060mbar

RECOMMENDED SOLDERING PROFILE

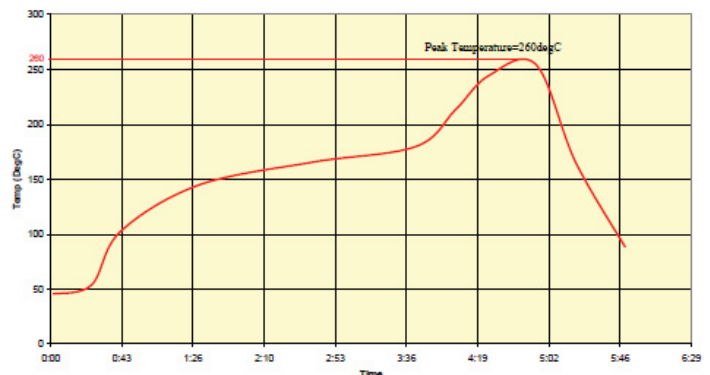

Thin-Film RF/Microwave Inductor Technology

Accu-L® Series

L0603 AND L0805 SMD High-Q RF Inductor – Accu-L®

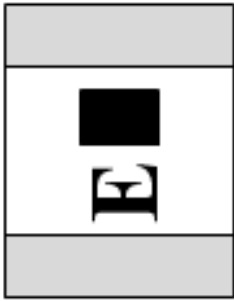

ACCU-L® TECHNOLOGY

The Accu-L® SMD Inductor is based on thin-film multilayer technology. This technology provides a level of control on the electrical and physical characteristics of the component which gives consistent characteristics within a lot and lot-to-lot.

The original design provides small size, excellent high-frequency performance and rugged construction for reliable automatic assembly.

The Accu-L® Inductor is particularly suited for the telecommunications industry where there is a continuing trend towards miniaturization and increasing frequencies. The Accu-L® inductor meets both the performance and tolerance requirements of present cellular frequencies 450MHz and 900MHz and of future frequencies, such as 1700MHz, 1900MHz and 2400MHz.

FEATURES

- Ultra-Tight Tolerance on Inductance
- RF Power Capability
- Low DC Resistance
- High SRF
- High Q

APPLICATIONS

- Vehicle Locations Systems
- Mobile Communications
- Satellite TV Receivers
- Matching Networks
- 5G Application
- Filters
- GPS

Not RoHS Compliant



For RoHS compliant products, please select correct termination style

HOW TO ORDER

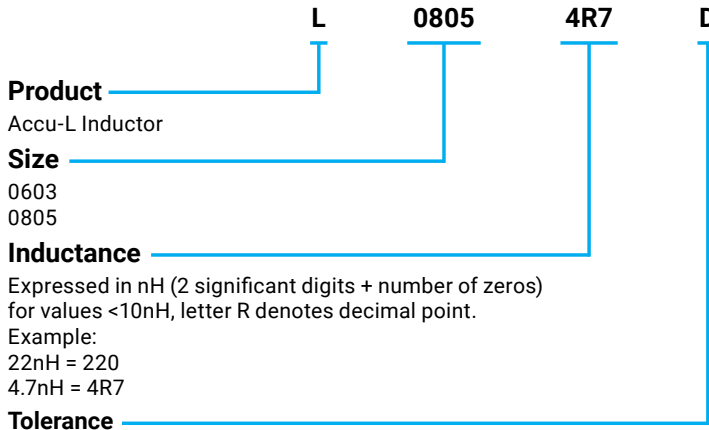

L ≤ 4.7nH	4.7nH < L < 10nH	L ≥ 10nH
B = ±0.1nH	C = ±0.2nH	G = ±2%
C = ±0.2nH	D = ±0.5nH	J = ±5%
D = ±0.5nH		

Packaging Code
TR = Tape and Reel (3,000/reel)

Termination Code
W = Nickel/Solder Coated (Sn 63, Pb 37)
**S = Nickel/Lead Free Solder Coated (Sn100)

Specification Code
E = Accu-L® 0805 technology
G = Accu-L® 0603 technology

****RoHS Compliant**

DIMENSIONS: millimeters (inches)

	0603	0805
L	1.6±0.10 (0.063±0.004)	2.11±0.10 (0.083±0.004)
W	0.81±0.10 (0.032±0.004)	1.5±0.10 (0.059±0.004)
T	0.61±0.10 (0.024±0.004)	0.91±0.13 (0.036±0.005)
B	top: 0.0 +0.3/-0.0 (0.0+0.012)	0.25±0.15 (0.010±0.006)
	bottom: 0.35±0.20 (0.014±0.008)	

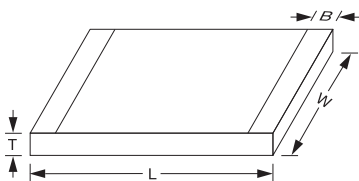

PART APPEARANCE (TOP VIEW)

ACCU-L 0603 (ALL VALUES)



ACCU-L 0805

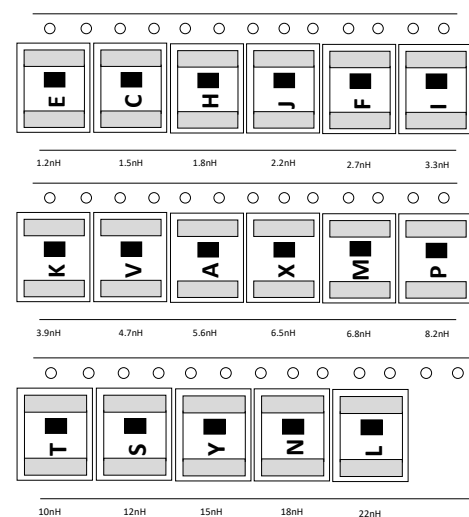

Thin-Film RF/Microwave Inductor Technology

Accu-L® Series

L0603 AND L0805 SMD High-Q RF Inductor – Accu-L®



ELECTRICAL SPECIFICATIONS TABLE FOR ACCU-L® 0603

450 MHz Test Frequency			900 MHz Test Frequency		1900 MHz Test Frequency		2400 MHz Test Frequency		SRF min. (MHz)	R _{DC} max. (Ω)	I _{DC} max. (mA) (1)
Inductance L (nH)	Available Inductance Tolerance	Q Typical	L (nH)	Q Typical	L (nH)	Q Typical	L (nH)	Q Typical			
1.2	±0.1, ±0.2nH	49	1.2	70	1.2	134	1.2	170	10000	0.04	1000
1.5	±0.1, ±0.2nH	26	1.54	39	1.52	63	1.52	76	10000	0.06	1000
1.8	±0.1, ±0.2nH	20	1.74	30	1.73	50	1.72	59	10000	0.07	1000
2.2	±0.1, ±0.2nH	20	2.2	30	2.24	49	2.24	56	10000	0.08	1000
2.7	±0.1, ±0.2nH	21	2.7	30	2.75	48	2.79	54	9000	0.08	750
3.3	±0.1, ±0.2, ±0.5nH	24	3.33	35	3.39	56	3.47	64	8400	0.08	750
3.9	±0.1, ±0.2, ±0.5nH	25	3.9	57	4.06	60	4.21	69	6500	0.12	500
4.7	±0.1, ±0.2, ±0.5nH	23	4.68	32	4.92	46	5.2	49	5500	0.15	500
5.6	±0.2, ±0.5nH	26	5.65	36	5.94	54	6.23	60	5000	0.25	300
6.8	±0.2, ±0.5nH	23	6.9	33	7.3	47	8.1	39	4500	0.30	300
8.2	±0.2, ±0.5nH	23	8.4	31	10	35	12.1	31	3800	0.35	300
10.0	±2%, ±5%	28	10	39	11.8	47	14.1	41	3500	0.45	300
12.0	±2%, ±5%	28	13.2	38	14.1	30	17.2	20	3000	0.50	300
15.0	±2%, ±5%	28	16.2	38	25.9	30	49.8	15	2500	0.60	300

(1) IDC measured for 15°C rise at 25°C ambient temperature when soldered to FR-4 board.
Inductance and Q measured on Agilent 4291B / 4287 using the 16196A test fixture.

ELECTRICAL SPECIFICATIONS TABLE FOR ACCU-L® 0805

450 MHz Test Frequency			900 MHz Test Frequency		1900 MHz Test Frequency		2400 MHz Test Frequency		SRF min. (MHz)	R _{DC} max. (Ω)	I _{DC} max. (mA)	
Inductance L (nH)	Available Inductance Tolerance	Q Typical	L (nH)	Q Typical	L (nH)	Q Typical	L (nH)	Q Typical			T = 15°C (1)	T = 70°C (2)
1.2	±0.1nH, ±0.2nH, ±0.5nH	60	1.2	92	1.2	122	1.2	92	10000	0.05	1000	2000
1.5	±0.1nH, ±0.2nH, ±0.5nH	50	1.5	74	1.5	102	1.5	84	10000	0.05	1000	2000
1.8	±0.1nH, ±0.2nH, ±0.5nH	50	1.8	72	1.8	88	1.9	73	10000	0.06	1000	2000
2.2	±0.1nH, ±0.2nH, ±0.5nH	42	2.2	62	2.2	82	2.3	72	10000	0.07	1000	2000
2.7	±0.1nH, ±0.2nH, ±0.5nH	42	2.7	62	2.8	80	2.9	70	10000	0.08	1000	2000
3.3	±0.1nH, ±0.2nH, ±0.5nH	38	3.3	46	3.4	48	3.5	57	10000	0.11	750	1500
3.9	±0.1nH, ±0.2nH, ±0.5nH	27	3.9	36	4.0	38	4.1	42	10000	0.20	750	1500
4.7	±0.1nH, ±0.2nH, ±0.5nH	43	4.8	62	5.3	76	5.8	60	5500	0.10	750	1500
5.6	±0.5nH	50	5.7	68	6.3	73	7.6	62	4600	0.10	750	1500
6.8	±0.5nH	43	7.0	62	7.7	71	9.4	50	4500	0.11	750	1500
8.2	±0.5nH	43	8.5	56	10.0	55	15.2	32	3500	0.12	750	1500
10	±2%, ±5%	46	10.6	60	13.4	52	-	-	2500	0.13	750	1500
12	±2%, ±5%	40	12.9	50	17.3	40	-	-	2400	0.20	750	1500
15	±2%, ±5%	36	16.7	46	27	23	-	-	2200	0.20	750	1000
18	±2%, ±5%	30	21.9	27	-	-	-	-	1700	0.35	500	1000
22	±2%, ±5%	36	27.5	33	-	-	-	-	1400	0.40	500	1000

(1) I_{DC} measured for 15°C rise at 25°C ambient temperature
(2) I_{DC} measured for 70°C rise at 25°C ambient temperature

L, Q, SRF measured on HP 4291A, Boonton 34A and Wiltron 360 Vector Analyzer, RDC measured on Keithley 580 micro-ohmmeter.

L0603

Typical Q vs. Frequency

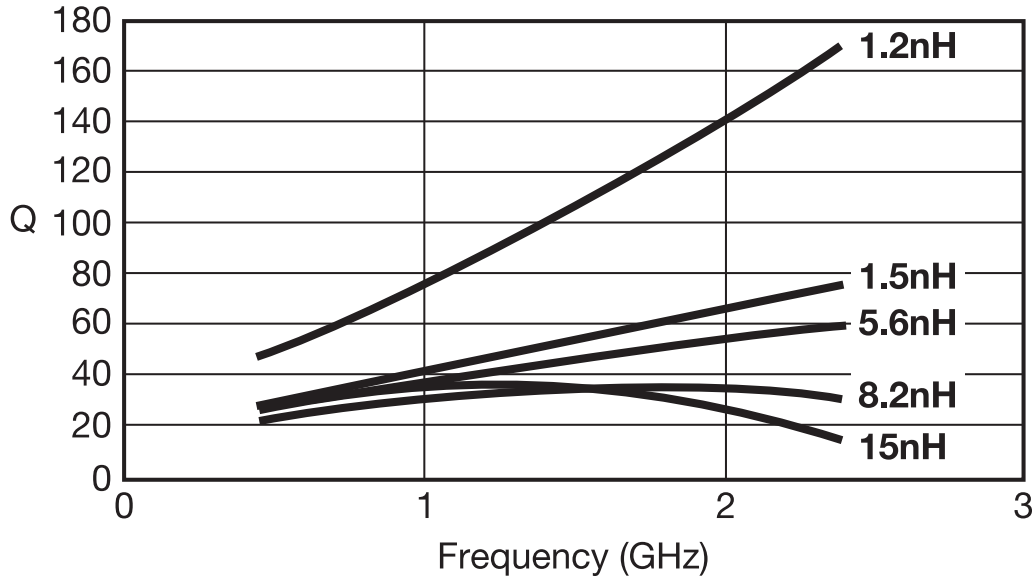

Measured on AGILENT 4291B/4287
using the 16196A test fixture

Typical Inductance vs. Frequency

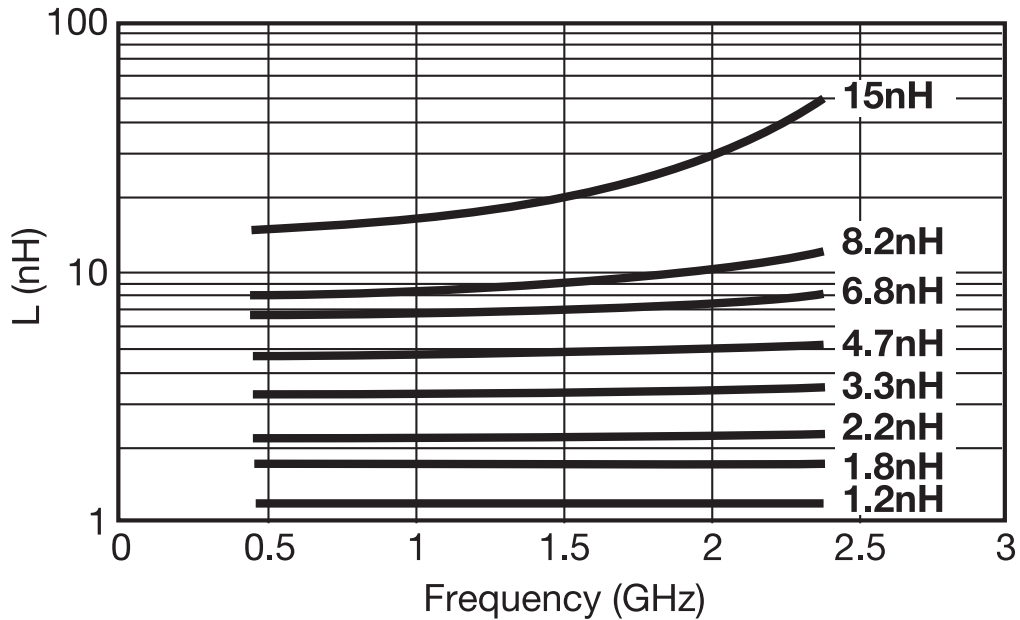

Measured on AGILENT 4291B/4287
using the 16196A test fixture

L0805

Typical Q vs. Frequency
L0805

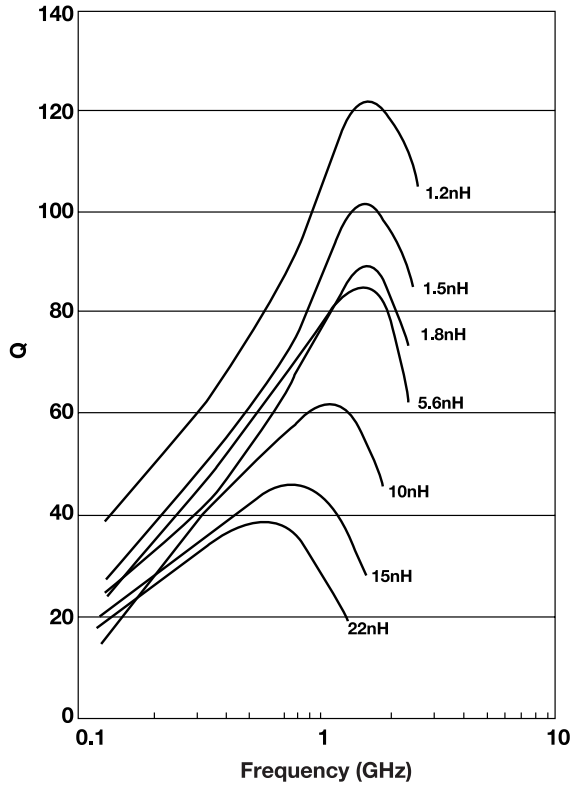

Measured on HP4291A and
Boonton 34A Coaxial Line

Typical Inductance vs. Frequency
L0805

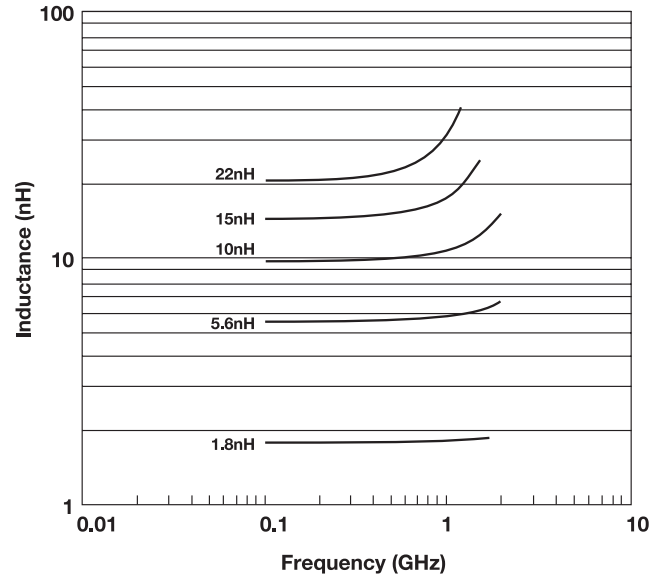

Measured on HP4291A and
Wiltron 360 Vector Analyzer

Maximum Temperature Rise at 25°C
Ambient Temperature (on FR-4)
L0805

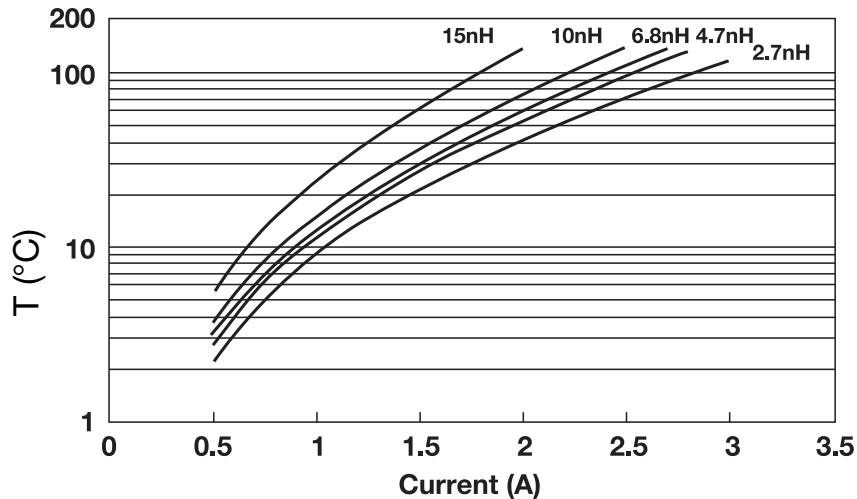

Temperature rise will typically be no higher than shown by the graph

FINAL QUALITY INSPECTION

Finished parts are tested for electrical parameters and visual/ mechanical characteristics.

Parts are 100% tested for inductance at 450MHz. Parts are 100% tested for RDC. Each production lot is evaluated on a sample basis for:

- Q at test frequency
- Static Humidity Resistance: 85°C, 85% RH, 160 hours
- Endurance: 125°C, I_R, 4 hours

ENVIRONMENTAL CHARACTERISTICS

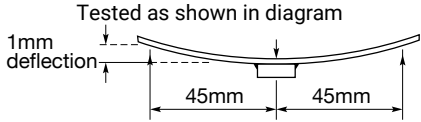
TEST	CONDITIONS	REQUIREMENT
Solderability	Components completely immersed in a solder bath at 235 ± 5°C for 2 secs.	Terminations to be well tinned. No visible damage.
Leach Resistance	Components completely immersed in a solder bath at 260 ± 5°C for 60 secs.	Dissolution of termination faces ≤ 15% of area. Dissolution of termination edges ≤ 25% of length.
Storage	12 months minimum with components stored in "as received" packaging.	Good solderability
Shear	Components mounted to a substrate. A force of 5N applied normal to the line joining the terminations and in a line parallel to the substrate.	No visible damage
Rapid Change of Temperature	Components mounted to a substrate. 5 cycles -55°C to +125°C.	No visible damage
Bend Strength	<p>Tested as shown in diagram</p> 	No visible damage
Temperature Coefficient of Inductance (TCL)	Component placed in environmental chamber -55°C to +125°C.	<p>+0 to +125 ppm/°C (typical) T1 = 25°C</p> $TCL = \frac{L_2 - L_1}{L_1 (T_2 - T_1)} \cdot 10^6$

HANDLING

SMD chips should be handled with care to avoid damage or contamination from perspiration and skin oils. The use of plastic tipped tweezers or vacuum pick-ups is strongly recommended for individual components. Bulk handling should ensure that abrasion and mechanical shock are minimized. For automatic equipment, taped and reeled product is the ideal medium for direct presentation to the placement machine.

CIRCUIT BOARD TYPE

All flexible types of circuit boards may be used (e.g. FR-4, G-10) and also alumina.

For other circuit board materials, please consult factory.

COMPONENT PAD DESIGN

Component pads must be designed to achieve good joints and minimize component movement during soldering.

Pad designs are given below for both wave and reflow soldering.

The basis of these designs is:

- Pad width equal to component width. It is permissible to decrease this to as low as 85% of component width but it is not advisable to go below this.
- Pad overlap about 0.3mm.
- Pad extension about 0.3mm for reflow.
Pad extension about 0.8mm for wave soldering.

REFLOW SOLDERING

DIMENSIONS: millimeters (inches)

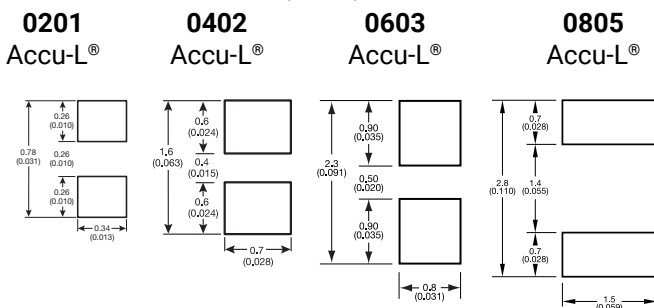

PREHEAT & SOLDERING

The rate of preheat in production should not exceed 4°C/second. It is recommended not to exceed 2°C/second.

Temperature differential from preheat to soldering should not exceed 150°C.

For further specific application or process advice, please consult KYOCERA AVX.

HAND SOLDERING & REWORK

Hand soldering is permissible. Preheat of the PCB to 100°C is required. The most preferable technique is to use hot air soldering tools. Where a soldering iron is used, a temperature controlled model not exceeding 30 watts should be used and set to not more than 260°C. Maximum allowed time at temperature is 1 minute. When hand soldering, the base side (white side) must be soldered to the board.

COOLING

After soldering, the assembly should preferably be allowed to cool naturally. In the event of assisted cooling, similar conditions to those recommended for preheating should be used.

CLEANING RECOMMENDATIONS

Care should be taken to ensure that the devices are thoroughly cleaned of flux residues, especially the space beneath the device. Such residues may otherwise become conductive and effectively offer a lossy bypass to the device. Various recommended cleaning conditions (which must be optimized for the flux system being used) are as follows:

- Cleaning liquids i-propanol, ethanol, acetone, water, and other standard PCB cleaning liquids.
- Ultrasonic conditions power – 20w/liter max.
frequency – 20kHz to 45kHz.
- Temperature 80°C maximum (if not otherwise limited by chosen solvent system).
- Time 5 minutes max.

STORAGE CONDITIONS

Recommended storage conditions for Accu-L® prior to use are as follows:

- Temperature 15°C to 35°C
- Humidity ≤65%
- Air Pressure 860mbar to 1060mbar

RECOMMENDED SOLDERING PROFILE

For recommended soldering profile see page 29



Thin-Film RF/Microwave Products

Accu-P[®]/Accu-L[®] Designer Kits

Thin-Film RF/Microwave Inductor Technology

Thin-Film RF/Microwave Products

Designer Kits



Accu-P®

Designer Kit Type 1700LF

Order Number: Accu-P® 0201KITL2

Volts	Capacitors Value (pF)	Tolerance
100	0.1	P
	0.2	P
	0.3	P
	0.4	P
	0.5	P
50	0.6	P
	0.7	P
	0.8	P
	0.9	P
	1.0	P
	1.1	A
	1.2	A
	1.3	A
25	1.5	A
	1.8	A
	2.0	B
	2.2	B
	2.4	B
	2.7	B
	3.0	B
	3.3	B
	3.6	B
	3.9	B
16	4.7	B
	5.6	B
	6.8	B
	7.5	B
	8.2	B
	10.0	G
	12.0	G

600 Capacitors, 20 each of 30 values

Tolerance P = 0.02pF A = ± 0.05pF
B = ± 0.1pF G = ± 2%

Accu-P®

Designer Kit Type 1800LF

Order Number: Accu-P® 0201KITL3

Volts	Capacitors Value (pF)	Tolerance
50	1.0	A
	1.1	A
	1.2	A
	1.3	A
	1.4	A
	1.5	A
	1.6	A
25	1.7	A
	1.8	A
	1.9	A
	2.0	A
	2.1	B
	2.2	B
	2.3	B
	2.4	B
	2.5	B
	2.6	B
	2.7	B
	2.8	B
	2.9	B
	3.0	B
	3.1	B
	3.3	B
	3.4	B
	3.6	B
	3.9	B
	4.1	B
	4.3	B
	4.5	B
	4.7	B

600 Capacitors, 20 each of 30 values

Tolerance A = ± 0.05pF
B = ± 0.1pF

Accu-P®

Designer Kit Type 1300LF

Order Number: Accu-P® 0402KITL1

Volts	Capacitors Value (pF)	Tolerance
100	0.1	P
	0.2	P
	0.3	P
	0.4	P
	0.5	P
	0.6	P
	0.7	P
	0.8	P
	0.9	P
	1.0	P
50	1.1	A
	1.2	A
	1.5	A
	1.8	A
	2.0	A
	2.2	B
	2.4	B
	2.7	B
	3.0	B
	3.3	B
25	3.9	B
	4.7	B
	5.6	B
	6.8	B
	8.2	B
	10.0	G
16	12.0	G
	15.0	G
	18.0	G
	22.0	G

600 Capacitors, 20 each of 30 values

Tolerance P = ± 0.02pF A = ± 0.05pF
B = ± 0.1pF G = ± 2%

Accu-P®

Designer Kit Type 1400LF

Order Number: Accu-P® 0402KITL2

Volts	Capacitors Value (pF)	Tolerance
100	1.0	A
	1.1	A
	1.2	A
	1.3	A
	1.4	A
	1.5	A
	1.6	A
	1.7	A
50	1.8	A
	1.9	A
	2.0	A
	2.1	B
	2.2	B
	2.3	B
	2.4	B
	2.5	B
	2.6	B
	2.7	B
	2.8	B
	2.9	B
	3.0	B
	3.1	B
	3.3	B
	3.4	B
	3.6	B
	3.9	B
	4.1	B
		4.3
4.5		B
4.7		B

600 Capacitors, 20 each of 30 values

Tolerance A = ± 0.05pF
B = ± 0.1pF

Thin-Film RF/Microwave Products

Accu-P®/Accu-L® Series

Designer Kits



Accu-P®

Designer Kit Type 900LF

Order Number: Accu-P® 0603KITL1

Volts	Capacitors Value (pF)	Tolerance
100	0.1	A
	0.2	A
	0.3	A
	0.4	B
	0.5	B
	0.6	B
	0.7	B
	0.8	B
	0.9	B
	1.0	B
	1.1	B
	1.2	B
	1.5	B
	1.8	B
	2.0	B
	2.2	B
	2.4	B
	2.7	B
50	3.0	B
	3.3	B
	3.9	B
	4.7	B
	5.6	B
	6.8	B
	8.2	B
	10.0	G
25	12.0	G
	15.0	G
	18.0	G
	22.0	G

600 Capacitors, 20 each of 30 values

Tolerance A = ± 0.05pF
B = ± 0.1pF
G = ± 2%

Accu-P®

Designer Kit Type 800LF

Order Number: Accu-P® 0805KITL2

Volts	Capacitors Value (pF)	Tolerance
100	0.1	A
	0.2	A
	0.3	A
	0.4	A
	0.5	B
	0.7	B
	0.8	B
	0.9	B
	1.0	B
	1.2	B
	1.5	B
	1.8	B
	2.0	B
	2.2	B
	2.7	B
	3.3	B
	3.9	B
	4.7	B
50	5.6	B
	6.8	B
	8.2	B
	10.0	G
	12.0	G
	15.0	G
	18.0	G
	22.0	G
25	27.0	J
	33.0	J
	39.0	J
	47.0	J

600 Capacitors, 20 each of 30 values

Tolerance A = ± 0.05pF G = ± 2%
B = ± 0.1pF J = ± 5%

Accu-P®

Designer Kit Type 2800LF

Order Number: Accu-P® 0201KITL5

Volts	Capacitors Value (pF)	Tolerance	
100	0.05	Z	
	0.10	Z	
	0.15	Z	
	0.20	Z	
	0.25	Z	
	0.30	Z	
	0.35	Z	
	0.40	Z	
	0.45	Z	
	0.50	Z	
	50	0.55	P
		0.60	P
0.65		P	
0.70		P	
0.75		P	
0.80		P	
0.85		P	
0.90		P	
0.95		P	
1.0		P	
1.1		P	
1.2		P	
25	1.3	P	
	1.4	P	
	1.5	P	
	1.6	P	
	1.7	P	
	1.8	P	
	1.9	P	
	2.0	P	

600 Capacitors, 20 each of 30 values

Tolerance Z = ± 0.01pF
P = ± 0.02pF

Accu-P®

Designer Kit Type 2700LF

Order Number: Accu-P® 0402KITL4

Volts	Capacitors Value (pF)	Tolerance
100	0.05	Z
	0.10	Z
	0.15	Z
	0.20	Z
	0.25	Z
	0.30	Z
	0.35	Z
	0.40	Z
	0.45	Z
	0.50	Z
	0.55	P
	0.60	P
	0.65	P
	0.70	P
	0.75	P
	0.80	P
	0.85	P
	50	0.90
0.95		P
1.0		P
1.1		P
1.2		P
1.3		P
1.4		P
1.5		P
25	1.6	P
	1.7	P
25	1.8	P
	1.9	P
25	2.0	P

600 Capacitors, 20 each of 30 values

Tolerance Z = ± 0.01pF
P = ± 0.02pF

Thin-Film RF/Microwave Products

Accu-P®/Accu-L® Series

Designer Kits



Accu-P®
Designer Kit Type 2200LF
Order Number: Accu-P® 0603KITL2

Volts	Capacitors Value (pF)	Tolerance
100	0.05	P
	0.10	P
	0.15	P
	0.20	P
	0.25	P
	0.30	P
	0.35	P
	0.40	P
	0.45	P
	0.50	P
	0.55	P
	0.60	P
	0.65	P
	0.70	P
	0.75	P

300 Capacitors, 20 each of 15 values
Tolerance P = ± 0.02pF

Accu-P®
Designer Kit Type 700
Order Number: Accu-P® 1210KIT02

Volts	Capacitors Value (pF)	Tolerance
100	1.0	B
	1.5	B
	1.8	B
	2.2	B
	2.7	B
	3.3	B
	4.7	B
	5.6	B
	6.8	B
	10.0	G
	12.0	G
	18.0	G
	22.0	G
	27.0	G
	33.0	G

150 Capacitors, 10 each of 15 values
Tolerance B = ± 0.1pF
G = ± 2%

Accu-L® 0201
Designer Kit Type 3200
Order Number: Accu-L® 0201KIT1

Inductance Value (nH)	Tolerance
0.33	A
0.39	A
0.47	A
0.56	A
0.68	A
0.82	A
1.0	A
1.2	A
1.5	B
1.8	B
2.2	B
2.7	B
3.3	B

260 Inductors, 20 each of 13 values
Tolerance A = ± 0.05pF
B = ± 0.1pF

Accu-L®
Designer Kit Type 2500
Order Number: Accu-L® L0402KIT01

Inductance Value (nH)	Tolerance
0.82	A
1.0	A
1.2	A
1.5	A
1.8	A
2.2	A
2.7	A
3.3	B
3.9	B
4.7	B
5.6	B
6.8	B

240 Inductors, 20 each of 12 values
Tolerance A = ± 0.05pF
B = ± 0.1pF

Accu-L®
Designer Kit Type 1600LF
Order Number: Accu-L® 0603KITL2

Inductance Value (nH)	Tolerance
1.2	C
1.5	C
1.8	C
2.2	C
2.7	C
3.3	C
3.9	C
4.7	C
5.6	C
6.8	C
8.2	C
10	G
12	G
15	G

280 Inductors, 20 each of 14 values
Tolerance C = ± 0.2nH
G = ± 2%

Accu-L®
Designer Kit Type 1100LF
Order Number: Accu-L® 0805KITL2

Inductance Value (nH)	Tolerance
1.8	C
2.2	C
2.7	C
3.3	C
3.9	C
4.7	C
5.6	C
6.8	D
8.2	D
10.0	J
12.0	J
15.0	J
18.0	J
22.0	J

280 Inductors, 20 each of 14 values
Tolerance C = ± 0.2nH
D = ± 0.5nH
J = ± 5%



Thin-Film RF/Microwave Directional Couplers

**CP0302/CP0402/CP0603/CP0805
and DB0603N/DB0805 3dB 90°**

Thin-Film RF/Microwave Directional Couplers

CP0302/CP0402/CP0603/CP0805 and DB0603N/DB0805 3dB 90°

CP0402W2700FNTR Wide Band High Directivity

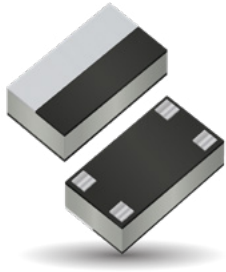

ITF TECHNOLOGY

The ITF High Directivity Wide Band LGA Coupler is based on thinfilm multilayer technology. The technology provides a miniature part with excellent high frequency performance and rugged construction for reliable automatic assembly.

The Wide Band High Directivity Coupler displays a stable coupling factor over a wide frequency band.

APPLICATIONS

- Mobile communications
- Satellite TV receivers
- GPS
- Vehicle location systems
- Wireless LAN's

LAND GRID ARRAY ADVANTAGES

- Inherent Low Profile
- Self Alignment during Reflow
- Excellent Solderability
- Low Parasitics
- Better Heat Dissipation

HOW TO ORDER

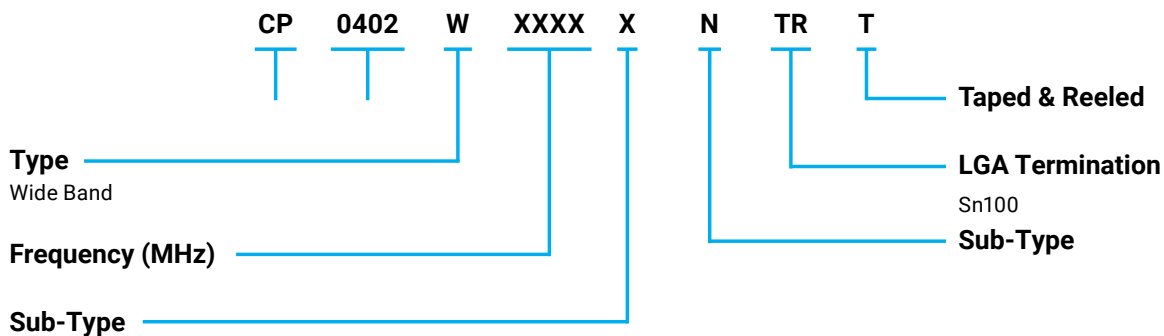

QUALITY INSPECTION

Finished parts are 100% tested for electrical parameters and visual characteristics. Each production lot is evaluated on a sample basis for:

- Static Humidity: 85°C, 85% RH, 160 hours
- Endurance: 125°C, I_R , 4 hours

TERMINATION

Nickel/Lead Free solder coating compatible with automatic soldering technologies: reflow, wave soldering, vapor phase and manual.

TERMINALS (TOP VIEW)

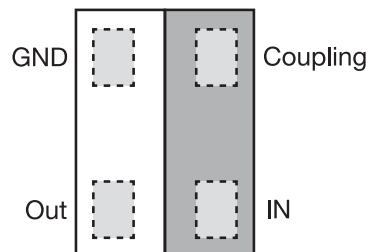

OPERATING TEMPERATURE

-40°C to +85°C

POWER RATING

3W RF Continuous

DIMENSIONS (BOTTOM VIEW)

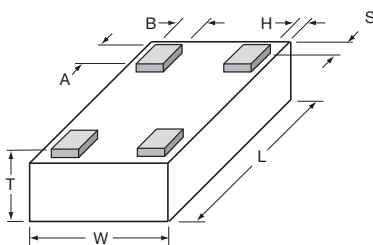

mm (inches)

L	1.00±0.05 (0.040±0.002)
W	0.58±0.04 (0.023±0.002)
T	0.35±0.05 (0.014±0.002)
A	0.20±0.05 (0.008±0.002)
B	0.18±0.05 (0.007±0.002)
S, H	0.05±0.05 (0.002±0.002)

Recommended Pad Layout Dimensions mm (inches)

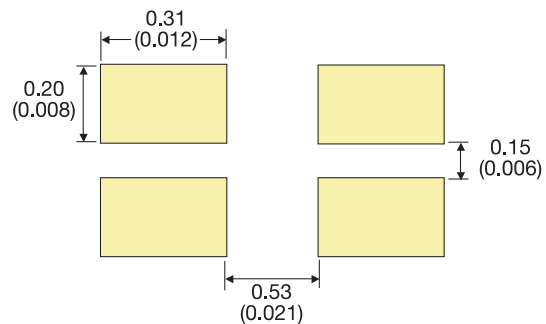

Thin-Film RF/Microwave Directional Couplers
CP0302/CP0402/CP0603/CP0805 and DB0603N/DB0805 3dB 90°
CP0402W2700FNTR Wide Band High Directivity



Directional Coupler Type CP0402W2700FNTR

P/N	Frequency [MHz]	Coupling [dB]	I. Loss max. [dB]	Return Loss [dB]	Directivity [dB]
CP0402W2700FNTR	700-2,700	24±2	0.3	18	20

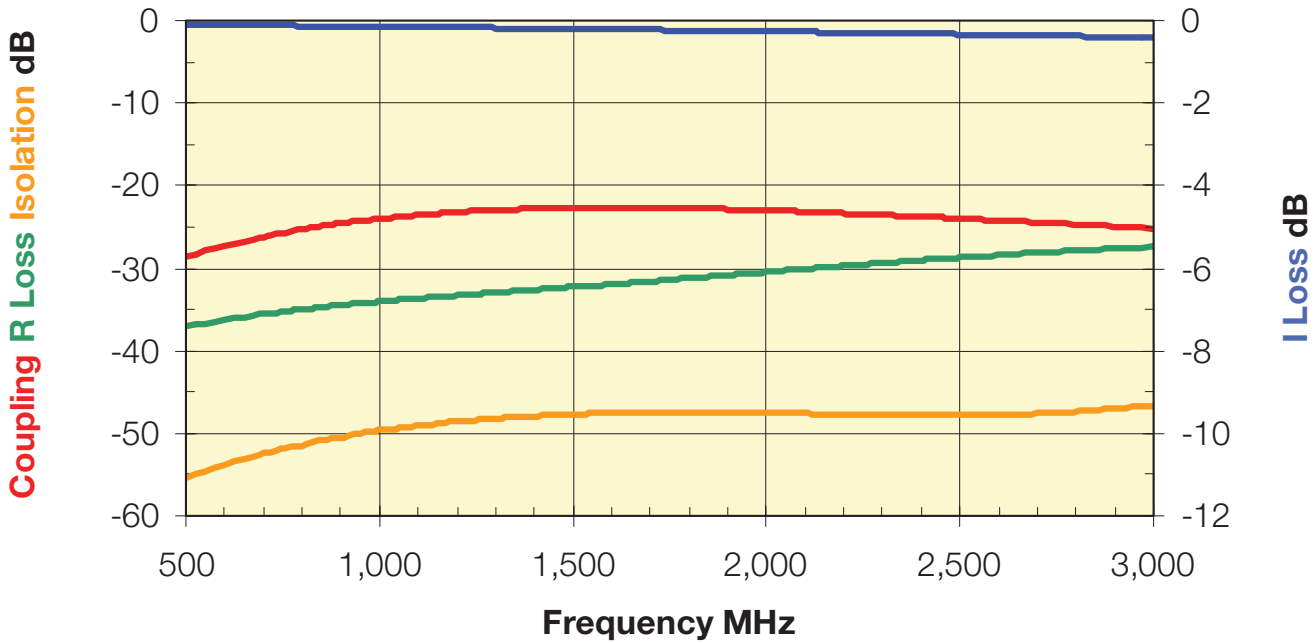

Broadband Directional Couplers

Lead-Free LGA Termination

CP0402W3800GNTR - High Directivity

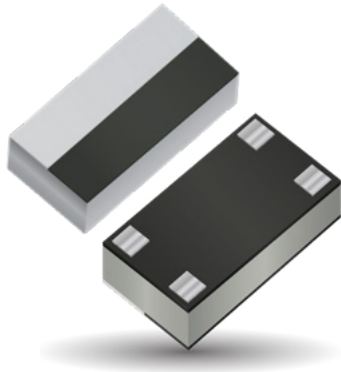

ITF TECHNOLOGY

The ITF High Directivity LGA Coupler is based on thin-film multilayer technology. The technology provides a miniature part with excellent high frequency performance and rugged construction for reliable automatic assembly.

The ITF Coupler is offered in a variety of frequency bands compatible with various types of high frequency wireless systems.

APPLICATIONS

- Mobile communications
- Satellite TV receivers
- GPS
- Vehicle location systems
- Wireless LAN's

LAND GRID ARRAY ADVANTAGES

- Inherent Low Profile
- Self Alignment during Reflow
- Excellent Solderability
- Low Parasitics
- Better Heat Dissipation

HOW TO ORDER

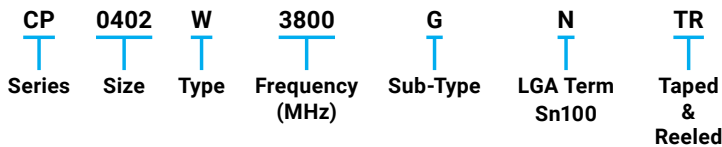

FINAL QUALITY INSPECTION

Finished parts are 100% tested for electrical parameters and visual/mechanical characteristics. Each production lot is evaluated on a sample basis for:

- Static Humidity: 85°C, 85% RH, 160 hours
- Endurance: 125°C, I_R, 4 hours

TERMINATION

Nickel/Lead-Free Solder coating (Sn100) compatible with automatic soldering technologies: reflow, wave soldering, vapor phase and manual.

OPERATING TEMPERATURE

-40°C to +85°C

POWER RATING

1W RF Continuous

NOTE

CP0402W3800GNTR includes a built in 50 Ohm resistor and does not require an external 50 Ohm resistor.

RECOMMENDED PAD LAYOUT: (mm)

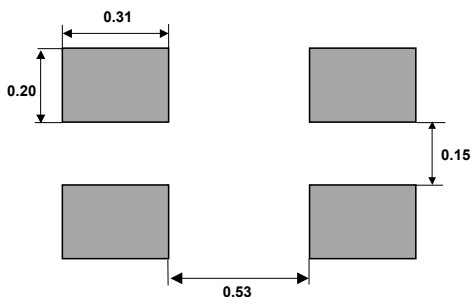

DIMENSIONS: mm (inches)

(Bottom View)

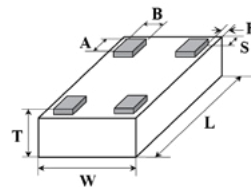

L	1.0±0.05 (0.040±0.002)
W	0.58±0.04 (0.023±0.002)
T	0.35±0.05 (0.014±0.002)

A	0.20±0.05 (0.008±0.002)
B	0.18±0.05 (0.007±0.002)
S	0.05±0.05 (0.002±0.002)

TERMINALS:

(Top View)

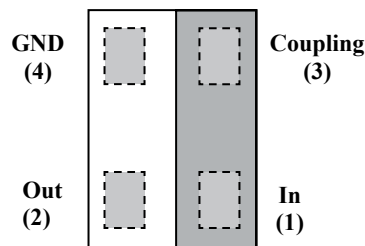

Broadband Directional Couplers

Lead-Free LGA Termination

CP0402W3800GNTR - High Directivity



DIRECTIONAL COUPLER TYPE CP0402W3800GNTR

P/N	FREQUENCY [MHz]	COUPLING [dB]	I. Loss max. [dB]	R.Loss [dB]	Directivity [dB]
CP0402W3800GNTR	700-3800	24±2.5	0.4	18	18

TYPICAL ELECTRICAL PERFORMANCE

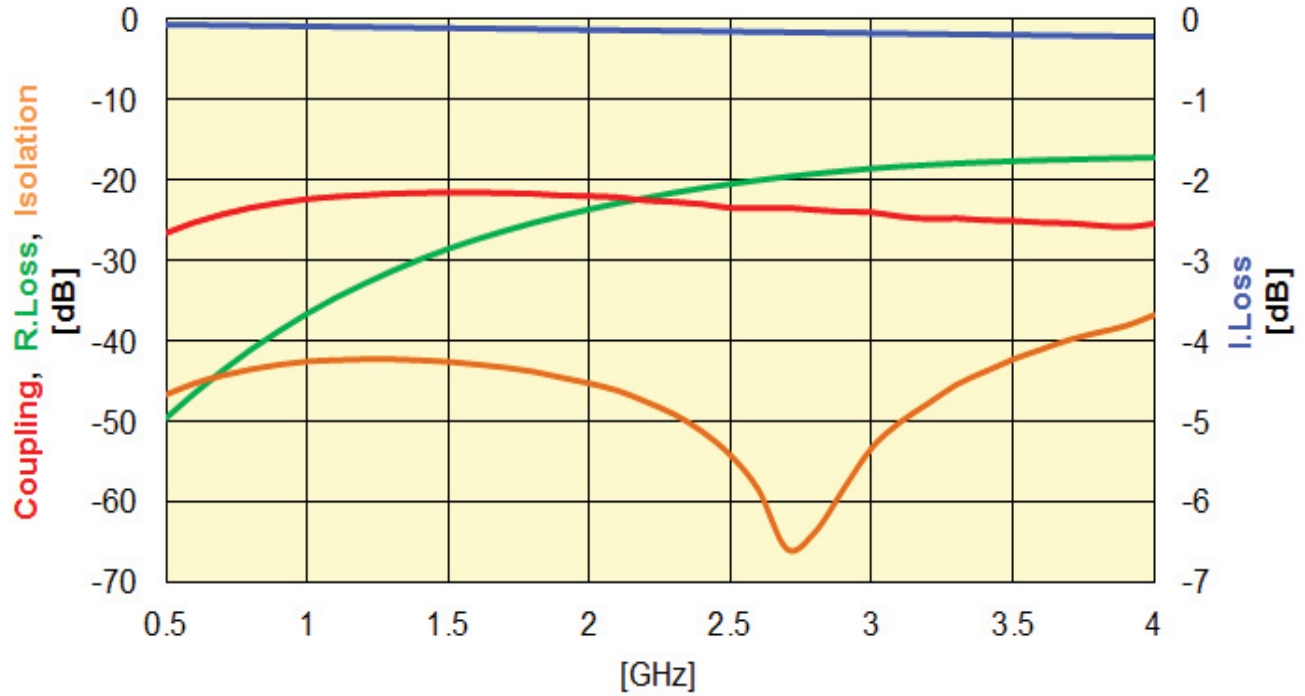

Broadband Directional Couplers

Lead-Free LGA Termination

CP0402W4500JNTR - High Directivity

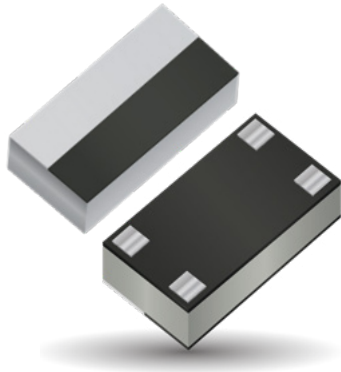

ITF TECHNOLOGY

The ITF High Directivity LGA Coupler is based on thin-film multilayer technology. The technology provides a miniature part with excellent high frequency performance and rugged construction for reliable automatic assembly.

The ITF Coupler is offered in a variety of frequency bands compatible with various types of high frequency wireless systems.

APPLICATIONS

- 5G Application
- Mobile communications
- Satellite TV receivers
- GPS
- Vehicle location systems

LAND GRID ARRAY ADVANTAGES

- Inherent Low Profile
- Self Alignment during Reflow
- Excellent Solderability
- Low Parasitics
- Better Heat Dissipation

HOW TO ORDER

CP Series
0402 Size
W Type
4500 Frequency (MHz)
J Sub-Type
N LGA Term Sn100
TR Taped & Reeled

FINAL QUALITY INSPECTION

Finished parts are 100% tested for electrical parameters and visual characteristics. Each production lot is evaluated on a sample basis for:

- Static Humidity: 85°C, 85% RH, 160 hours
- Endurance: 125°C, I_R, 4 hours

TERMINATION

Nickel/Lead-Free Solder coating (Sn100) compatible with automatic soldering technologies: reflow, wave soldering, vapor phase and manual.

OPERATING TEMPERATURE

-40°C to +85°C

POWER RATING

1W RF Continuous

RECOMMENDED PAD LAYOUT: (mm)

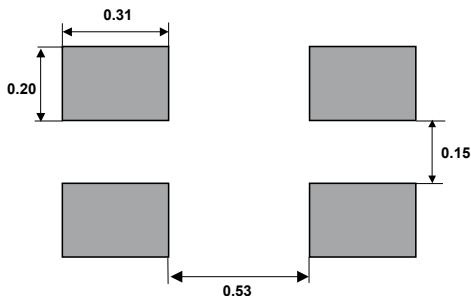

DIMENSIONS: mm (inches)

(Bottom View)

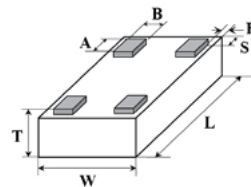

L	1.0±0.05 (0.040±0.002)
W	0.58±0.04 (0.023±0.002)
T	0.35±0.05 (0.014±0.002)

A	0.20±0.05 (0.008±0.002)
B	0.18±0.05 (0.007±0.002)
S	0.05±0.05 (0.002±0.002)

TERMINALS:

(Top View)

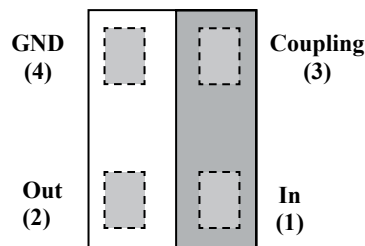

Broadband Directional Couplers

Lead-Free LGA Termination

CP0402W4500JNTR - High Directivity



DIRECTIONAL COUPLER TYPE CP0402W3800GNTTR

P/N	FREQUENCY [MHz]	COUPLING [dB]	I. Loss [dB]	R.Loss [dB]	Directivity [dB]
CP0402W4500JNTR	2000-7000	20±2	0.6	15	15

TYPICAL ELECTRICAL PERFORMANCE

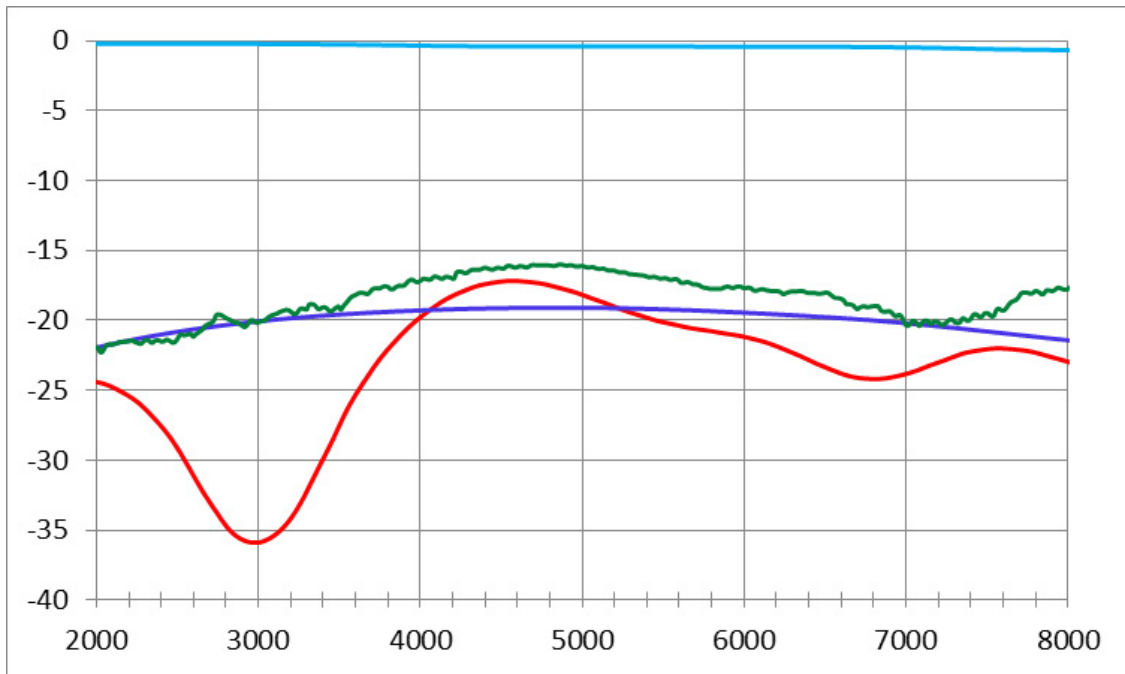

Thin-Film RF/Microwave Directional Couplers

CP0302/CP0402/CP0603/CP0805 and DB0603N/DB0805 3dB 90°

High Directivity Directional Couplers For WiFi Bands



CP0302P5425ENTR / CP0302A5425ENTR / CP0402Q5425ENTR / CP0603Q5425ENTR

TECHNOLOGY

These High Directivity LGA Couplers are based on thin-film multilayer technology. The technology provides a miniature part with excellent high frequency performance and rugged construction for reliable automatic assembly. The WiFi Bands Couplers are offered in 0302, 0402 and 0603 standard sizes having identical electrical performance.

APPLICATIONS:

- WiFi
- 4G LTE
- 5G LTE
- Base Stations.
- Automotive
- Industrial



PART NUMBERS

CP0302P5425ENTR

CP0302A5425ENTR

CP0402Q5425ENTR

CP0603Q5425ENTR

QUALITY INSPECTION

Finished parts are 100% tested for electrical parameters and visual characteristics. Each production lot is evaluated on a sample basis for:

- Static Humidity: 85°C, 85% RH, 160 hours
- Endurance : 125°C, I_R, 4 hours

TERMINATION

Nickel/Lead-Free Solder coating (Sn100) compatible with automatic soldering technologies: reflow, wave soldering, vapor phase and manual.

OPERATING TEMPERATURE

-40°C to +85°C

TERMINALS (TOP VIEW)

DIMENSIONS (BOTTOM VIEW)

mm (inches)

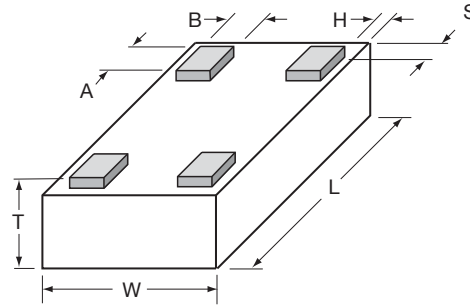

	CP0302	CP0402	CP0603
L	0.65±0.04 (0.026±0.002)	1.0±0.05 (0.040±0.002)	1.6±0.1 (0.063±0.004)
W	0.50±0.04 (0.02±0.002)	0.58±0.04 (0.023±0.002)	0.84±0.1 (0.033±0.004)
T	0.25±0.05 (0.01±0.002)	0.35±0.05 (0.014±0.002)	0.60±0.1 (0.024±0.004)
A	0.20±0.05 (0.008±0.002)	0.20±0.05 (0.008±0.002)	0.25±0.05 (0.01±0.002)
B	0.10±0.04 (0.004±0.002)	0.18±0.05 (0.007±0.002)	0.20±0.05 (0.008±0.002)
S, H	0.025±0.025 (0.001±0.001)	0.05±0.05 (0.002±0.002)	0.05±0.05 (0.002±0.002)

RECOMMENDED PAD LAYOUT

DIMENSIONS:

mm (inches)

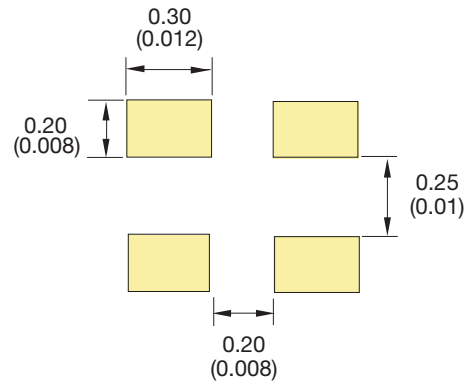

CP0302

CP0402 / CP0603: see pages 49 / 53

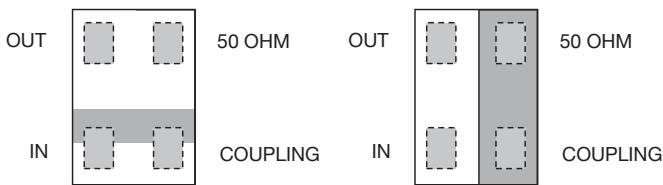

CP0302

CP0402

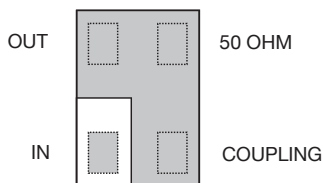

CP0603

Thin-Film RF/Microwave Directional Couplers

CP0302/CP0402/CP0603/CP0805 and DB0603N/DB0805 3dB 90°

High Directivity Directional Couplers For WiFi Bands



ELECTRICAL CHARACTERISTICS

P/N	Frequency [MHz]	Coupling [dB]	I. Loss max. [dB]	Return Loss [dB]	Directivity [dB]
CP0302P5425ENTR	2,400-2,496	-20±0.5	-0.2	-30	20
	4,900-5,950	-13±0.5	-0.4	-25	20

P/N	Frequency [MHz]	Coupling [dB]	I. Loss max. [dB]	Return Loss [dB]	Directivity [dB]
CP0302A5425ENTR	2,400-2,496	-20±1	-0.2	-30	20
	4,900-5,950	-13±1	-0.4	-25	20

P/N	Frequency [MHz]	Coupling [dB]	I. Loss max. [dB]	Return Loss [dB]	Directivity [dB]
CP0402Q5425ENTR	2,400-2,496	-20±1	-0.3	-30	20
CP0603Q5425ENTR	4,900-5,950	-13±1	-0.4	-25	20

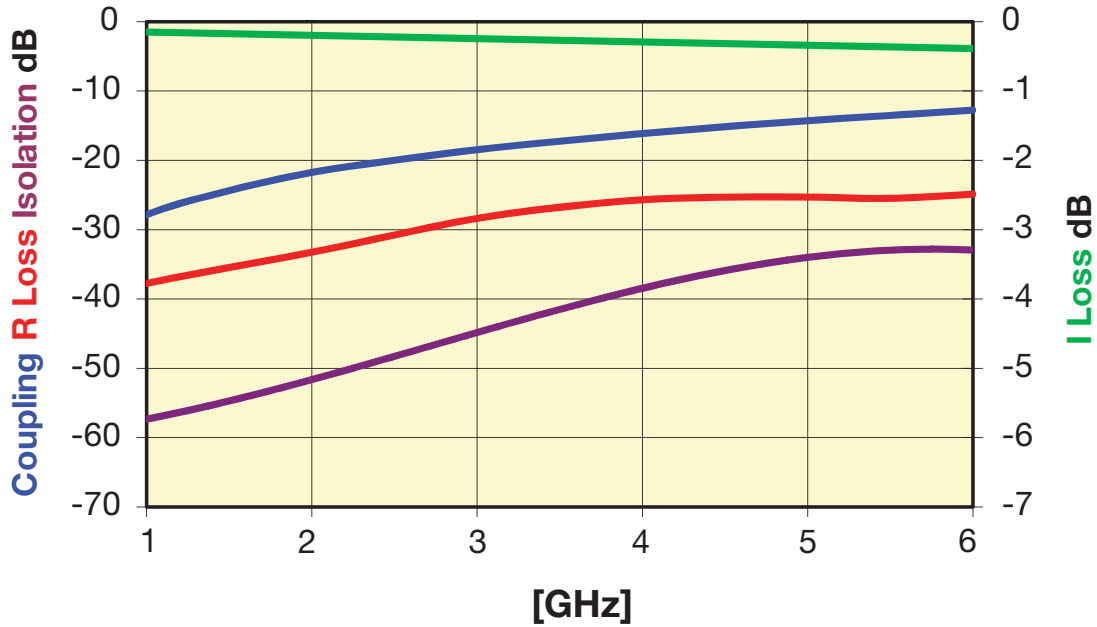

Thin-Film RF/Microwave Directional Couplers

CP0302/CP0402/CP0603/CP0805 and DB0603N/DB0805 3dB 90°

CP0402P High Directivity, Tight Coupling Tolerance



GENERAL DESCRIPTION

ITF (INTEGRATED THIN-FILM) TECHNOLOGY

The CP0402P Series High Directivity, Tight Coupling Tolerance LGA Coupler is based on the proprietary RFAP Thin-Film multilayer technology. The technology provides a miniature part with excellent high frequency performance and rugged construction for reliable automatic assembly.

The ITF Coupler is offered in a variety of frequency bands compatible with various types of high frequency wireless systems.

APPLICATIONS

- 4G LTE
- 5G LTE
- Base Stations.
- Automotive
- Industrial
- Wireless communications
- Wireless LAN's
- GPS
- WiMAX

LAND GRID ARRAY ADVANTAGES

- Inherent Low Profile
- Self Alignment during Reflow
- Excellent Solderability
- Low Parasitics
- Better Heat Dissipation
- Power Rating 3W RF Continuous

DIMENSIONS: (Bottom View)

millimeters (inches)

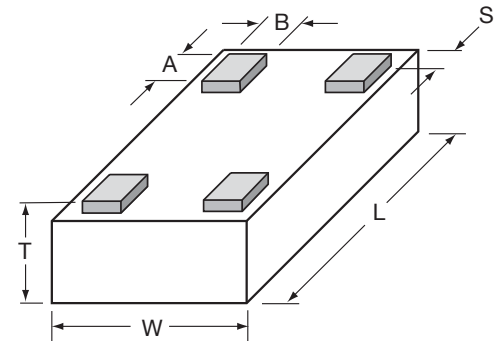

L	1.00±0.05 (0.040±0.002)
W	0.58±0.04 (0.023±0.002)
T	0.35±0.05 (0.014±0.002)

A	0.20±0.05 (0.008±0.002)
B	0.18±0.05 (0.007±0.002)
S	0.05±0.05 (0.002±0.002)

HOW TO ORDER

CP	0402	P	XXXX	X	N	TR
Style	Size	Type	Frequency	Sub-Type	Termination	Taped & Reeled
	0402	±0.5dB Tight Tolerance	MHz		LGA Lead-Free	

QUALITY INSPECTION

Finished parts are 100% tested for electrical parameters and visual characteristics. Each production lot is evaluated on a sample basis for:

- Static Humidity: 85°C, 85% RH, 160 hours
- Endurance: 125°C, IR, 4 hours

TERMINATION

Nickel/Lead-Free Solder coating compatible with automatic soldering technologies: reflow, wave soldering, vapor phase and manual.

OPERATING TEMPERATURE:

-40°C to +85°C

TERMINALS (TOP VIEW)

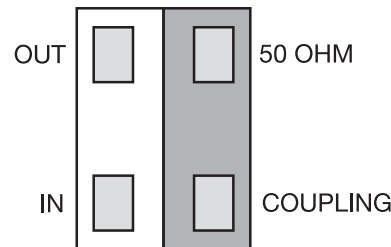

RECOMMENDED PAD LAYOUT DIMENSIONS :

mm (inches)

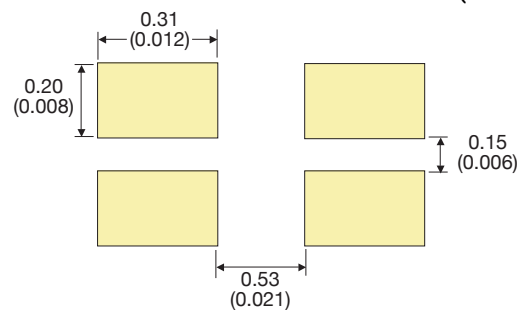

Thin-Film RF/Microwave Directional Couplers

CP0302/CP0402/CP0603/CP0805 and DB0603N/DB0805 3dB 90°

CP0402P High Directivity, Tight Coupling Tolerance



Coupler P/N CP0402PxxxxAN

P/N Examples*	Frequency Band [MHz]	Coupling [dB]	I. Loss max. [dB]	Return Loss [dB]	Directivity [dB]
CP0402P0836AN	824 - 849	19.10±0.5	0.25	32	21
CP0402P0881AN	869 - 894	18.60±0.5	0.25	31	21
CP0402P0902AN	890 - 915	18.50±0.5	0.25	31	21
CP0402P0947AN	935 - 960	18.00±0.5	0.25	31	21
CP0402P0897AN	880 - 915	18.50±0.5	0.25	31	21
CP0402P0942AN	925 - 960	18.00±0.5	0.25	31	21
CP0402P1441AN	1429 - 1453	14.50±0.5	0.40	28	21
CP0402P1747AN	1710 - 1785	13.00±0.5	0.50	26	21
CP0402P1842AN	1805 - 1880	12.50±0.5	0.50	26	21
CP0402P1880AN	1850 - 1910	12.30±0.5	0.50	25	21
CP0402P1960AN	1930 - 1990	12.00±0.5	0.50	25	21
CP0402P1907AN	1895 - 1920	12.30±0.5	0.50	25	21
CP0402P1890AN	1880 - 1900	12.30±0.5	0.50	25	21
CP0402P2442AN	2400 - 2484	10.30±0.5	0.70	23	21
CP0402P3500AN	3450 - 3550	7.60±0.5	1.30	15	14
CP0402P5000AN	4950 - 5050	5.00±0.5	1.50	15	13
CP0402P5500AN	5450 - 5550	4.60±0.5	1.50	14	13
CP0402P6000AN	5950 - 6050	4.00±0.5	1.50	14	13

CP0402PxxxxANTR

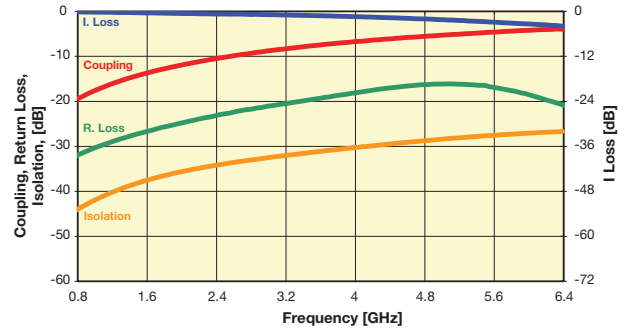

Coupler P/N CP0402PxxxxBN

P/N Examples*	Frequency Band [MHz]	Coupling [dB]	I. Loss max. [dB]	Return Loss [dB]	Directivity [dB]
CP0402P0836BN	824 - 849	22.00±0.5	0.20	28	27
CP0402P0881BN	869 - 894	21.70±0.5	0.20	28	27
CP0402P0902BN	890 - 915	21.50±0.5	0.20	28	27
CP0402P0947BN	935 - 960	21.00±0.5	0.25	27	27
CP0402P0897BN	880 - 915	21.50±0.5	0.20	28	27
CP0402P0942BN	925 - 960	21.00±0.5	0.25	27	27
CP0402P1441BN	1429 - 1453	17.50±0.5	0.25	24	27
CP0402P1747BN	1710 - 1785	16.00±0.5	0.30	23	27
CP0402P1842BN	1805 - 1880	15.50±0.5	0.35	23	27
CP0402P1880BN	1850 - 1910	15.50±0.5	0.35	23	27
CP0402P1960BN	1930 - 1990	15.00±0.5	0.35	22	27
CP0402P1907BN	1895 - 1920	15.50±0.5	0.35	23	27
CP0402P1890BN	1880 - 1900	15.50±0.5	0.35	23	27
CP0402P2442BN	2400 - 2484	13.30±0.5	0.40	21	27
CP0402P3500BN	3450 - 3550	9.40±0.5	0.80	18	14
CP0402P5000BN	4950 - 5050	7.40±0.5	1.20	14	13
CP0402P5500BN	5450 - 5550	6.70±0.5	1.60	14	13
CP0402P6000BN	5950 - 6050	6.10±0.5	2.00	14	13

CP0402PxxxxBNTR

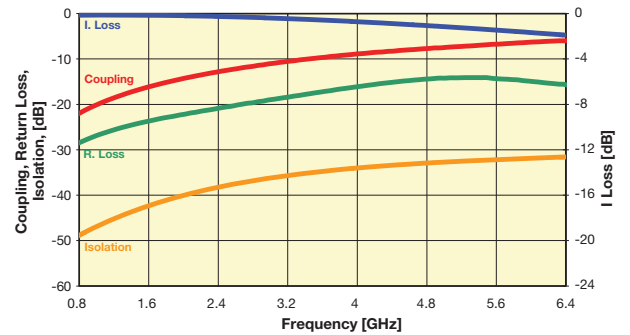

Coupler P/N CP0402PxxxxEN

P/N Examples*	Frequency Band [MHz]	Coupling [dB]	I. Loss max. [dB]	Return Loss [dB]	Directivity [dB]
CP0402P0836EN	824 - 849	27.20±0.5	0.20	35	25
CP0402P0881EN	869 - 894	26.80±0.5	0.20	34	25
CP0402P0902EN	890 - 915	26.50±0.5	0.20	34	25
CP0402P0947EN	935 - 960	26.00±0.5	0.20	34	25
CP0402P0897EN	880 - 915	26.50±0.5	0.20	34	25
CP0402P0942EN	925 - 960	26.00±0.5	0.20	34	25
CP0402P1441EN	1429 - 1453	22.30±0.5	0.25	29	25
CP0402P1747EN	1710 - 1785	20.50±0.5	0.25	27	23
CP0402P1842EN	1805 - 1880	20.30±0.5	0.25	26	23
CP0402P1880EN	1850 - 1910	20.00±0.5	0.25	26	23
CP0402P1960EN	1930 - 1990	20.00±0.5	0.25	26	23
CP0402P1907EN	1895 - 1920	20.00±0.5	0.25	26	23
CP0402P1890EN	1880 - 1900	20.00±0.5	0.25	26	23
CP0402P2442EN	2400 - 2484	18.00±0.5	0.35	23	23
CP0402P3500EN	3450 - 3550	15.00±0.5	0.37	20	16
CP0402P5000EN	4950 - 5050	12.50±0.5	0.50	18	13
CP0402P5500EN	5450 - 5550	11.50±0.5	0.65	16	13
CP0402P6000EN	5950 - 6050	11.10±0.5	0.70	15	13

CP0402PxxxxENTR

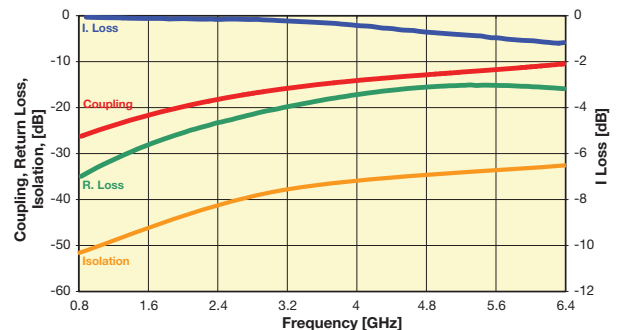

Thin-Film RF/Microwave Directional Couplers

CP0302/CP0402/CP0603/CP0805 and DB0603N/DB0805 3dB 90°

CP0402 High Directivity LGA Termination



GENERAL DESCRIPTION

ITF (INTEGRATED THIN-FILM) TECHNOLOGY

The ITF High Directivity LGA Coupler is based on thin-film multilayer technology. The technology provides a miniature part with excellent high frequency performance and rugged construction for reliable automatic assembly.

The ITF Coupler is offered in a variety of frequency bands compatible with various types of high frequency wireless systems.

APPLICATIONS

- 4G LTE
- 5G LTE
- Base Stations.
- Automotive
- Industrial
- Mobile Communications
- Satellite TV Receivers
- GPS
- Vehicle Location Systems
- Wireless LAN's

FEATURES

- Inherent Low Profile
- Self Alignment during Reflow
- Excellent Solderability
- Low Parasitics
- Better Heat Dissipation
- Operating/Storage Temp -40°C to +85°C
- Power Rating 3W RF Cont

DIMENSIONS:

millimeters (inches)

(Bottom View)

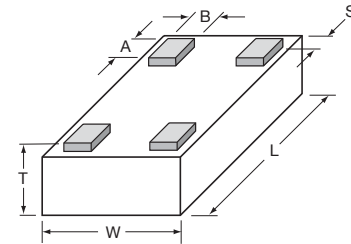

L	1.00±0.05 (0.040±0.002)	A	0.20±0.05 (0.008±0.002)
W	0.58±0.04 (0.023±0.002)	B	0.18±0.05 (0.007±0.002)
T	0.35±0.05 (0.014±0.002)	S	0.05±0.05 (0.002±0.002)

HOW TO ORDER

CP
T
Style
Directional Coupler

0402
T
Size
0402

X
T
Type

T
Frequency
MHz

X
T
Sub-Type

N
T
LGA Termination
L = LGA Sn90, Pb10
**N = LGA Sn100

TR
T
Packaging Code
TR = Tape and Reel

**RoHS compliant

QUALITY INSPECTION

Finished parts are 100% tested for electrical parameters and visual characteristics. Each production lot is evaluated on a sample basis for:

- Static Humidity: 85°C, 85% RH, 160 hours
- Endurance: 125°C, I_R, 4 hours

TERMINATION

Sn90Pb10 or Lead-Free Sn100 Nickel/Solder coating compatible with automatic soldering technologies: reflow, wave soldering, vapor phase and manual.

ORIENTATION IN TAPE

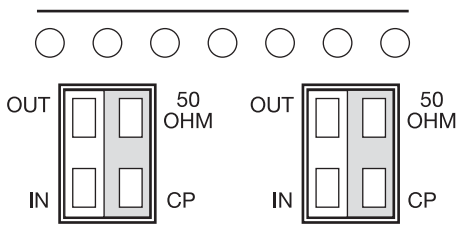

TERMINALS (TOP VIEW)

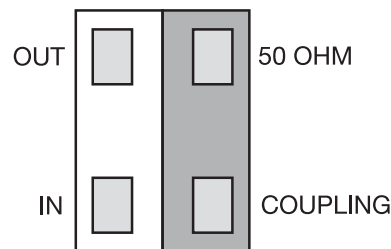

Not RoHS Compliant



LEAD-FREE
LEAD-FREE COMPATIBLE
COMPONENT



For RoHS compliant products,
please select correct termination style.

Recommended Pad Layout Dimensions

mm (inches)

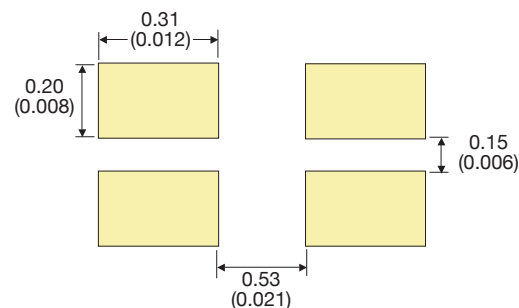

*The recommended distance to the PCB Ground Plane is 0.254mm (0.010")

Thin-Film RF/Microwave Directional Couplers
CP0302/CP0402/CP0603/CP0805 and DB0603N/DB0805 3dB 90°
CP0402 High Directivity LGA Termination



CP0402 - TYPE SELECTION CHART

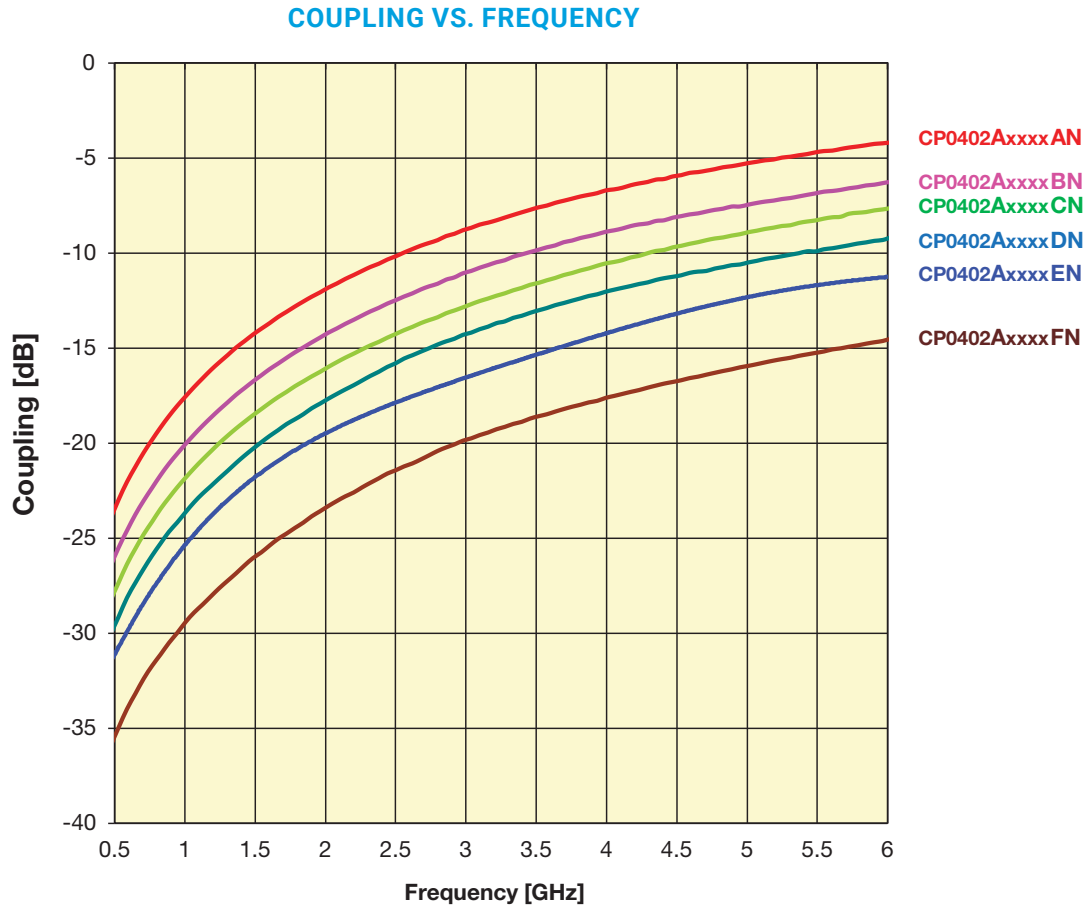

Intermediate coupling factors are readily available.
 Please contact factory.

Thin-Film RF/Microwave Directional Couplers

CP0302/CP0402/CP0603/CP0805 and DB0603N/DB0805 3dB 90°

CP0402 High Directivity LGA Termination



Coupler P/N CP0402AxxxxAN

P/N Examples*	Frequency Band [MHz]	Coupling [dB]	I. Loss max. [dB]	Return Loss [dB]	Directivity [dB]
CP0402A0836AN	824 - 849	19.10	0.25	32	21
CP0402A0881AN	869 - 894	18.60	0.25	31	21
CP0402A0902AN	890 - 915	18.50	0.25	31	21
CP0402A0947AN	935 - 960	18.00	0.25	31	21
CP0402A0897AN	880 ÷ 915	18.50	0.25	31	21
CP0402A0942AN	925 ÷ 960	18.00	0.25	31	21
CP0402A1441AN	1429 - 1453	14.50	0.40	28	21
CP0402A1747AN	1710 - 1785	13.00	0.50	26	21
CP0402A1842AN	1805 - 1880	12.50	0.50	26	21
CP0402A1880AN	1850 - 1910	12.30	0.50	25	21
CP0402A1960AN	1930 - 1990	12.00	0.50	25	21
CP0402A1907AN	1895 - 1920	12.30	0.50	25	21
CP0402A1890AN	1880 - 1900	12.30	0.50	25	21
CP0402A2442AN	2400 - 2484	10.30	0.70	23	21
CP0402A3500AN	3450 - 3550	7.60	1.30	15	14
CP0402A5000AN	4950 - 5050	5.00	1.50	15	13
CP0402A5500AN	5450 - 5550	4.60	1.50	14	13
CP0402A6000AN	5950 - 6050	4.00	1.50	14	13

CP0402AxxxxANTR

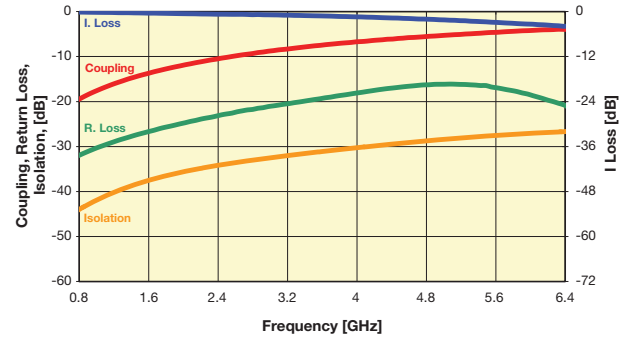

Coupler P/N CP0402AxxxxBN

P/N Examples*	Frequency Band [MHz]	Coupling [dB]	I. Loss max. [dB]	Return Loss [dB]	Directivity [dB]
CP0402A0836BN	824 - 849	22.00	0.20	28	27
CP0402A0881BN	869 - 894	21.70	0.20	28	27
CP0402A0902BN	890 - 915	21.50	0.20	28	27
CP0402A0947BN	935 - 960	21.00	0.25	27	27
CP0402A0897BN	880 ÷ 915	21.50	0.20	28	27
CP0402A0942BN	925 ÷ 960	21.00	0.25	27	27
CP0402A1441BN	1429 - 1453	17.50	0.25	24	27
CP0402A1747BN	1710 - 1785	16.00	0.30	23	27
CP0402A1842BN	1805 - 1880	15.50	0.35	23	27
CP0402A1880BN	1850 - 1910	15.50	0.35	23	27
CP0402A1960BN	1930 - 1990	15.00	0.35	22	27
CP0402A1907BN	1895 - 1920	15.50	0.35	23	27
CP0402A1890BN	1880 - 1900	15.50	0.35	23	27
CP0402A2442BN	2400 - 2484	13.30	0.40	21	27
CP0402A3500BN	3450 - 3550	9.40	0.80	18	14
CP0402A5000BN	4950 - 5050	7.40	1.20	14	13
CP0402A5500BN	5450 - 5550	6.70	1.60	14	13
CP0402A6000BN	5950 - 6050	6.10	2.00	14	13

CP0402AxxxxBNTR

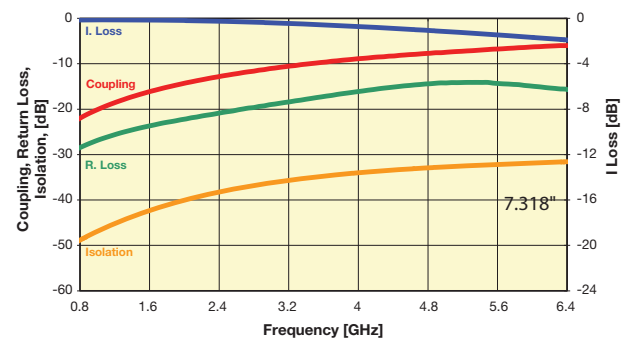

Coupler P/N CP0402AxxxxCN

P/N Examples*	Frequency Band [MHz]	Coupling [dB]	I. Loss max. [dB]	Return Loss [dB]	Directivity [dB]
CP0402A0836CN	824 - 849	23.60	0.20	33	22
CP0402A0881CN	869 - 894	23.00	0.20	33	22
CP0402A0902CN	890 - 915	23.00	0.20	26	22
CP0402A0947CN	935 - 960	22.50	0.20	33	22
CP0402A0897CN	880 ÷ 915	23.00	0.20	25	22
CP0402A0942CN	925 ÷ 960	22.50	0.20	32	22
CP0402A1441CN	1429 - 1453	19.00	0.25	31	22
CP0402A1747CN	1710 - 1785	17.20	0.25	30	19
CP0402A1842CN	1805 - 1880	17.00	0.25	30	19
CP0402A1880CN	1850 - 1910	16.80	0.25	30	19
CP0402A1960CN	1930 - 1990	16.50	0.25	29	19
CP0402A1907CN	1895 - 1920	16.80	0.25	29	19
CP0402A1890CN	1880 - 1900	16.80	0.25	30	19
CP0402A2442CN	2400 - 2484	14.70	0.45	28	19
CP0402A3500CN	3450 - 3550	10.97	0.67	23	17
CP0402A5000CN	4950 - 5050	8.00	1.00	21	16
CP0402A5500CN	5450 - 5550	7.50	1.10	21	15
CP0402A6000CN	5950 - 6050	7.10	1.30	23	15

CP0402AxxxxCNTR

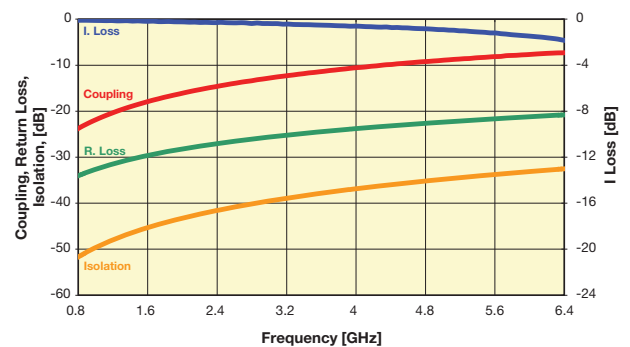

Important: Couplers can be used at any frequency within the indicated range.



The Important Information/Disclaimer is incorporated in the catalog where these specifications came from or available online at www.kyocera-avx.com/disclaimer/ by reference and should be reviewed in full before placing any order.

Thin-Film RF/Microwave Directional Couplers

CP0302/CP0402/CP0603/CP0805 and DB0603N/DB0805 3dB 90°

CP0402 High Directivity LGA Termination



Coupler P/N CP0402AxxxxDN

P/N Examples*	Frequency Band [MHz]	Coupling [dB]	I. Loss max. [dB]	Return Loss [dB]	Directivity [dB]
CP0402A0836DN	824 - 849	25.20	0.20	29	20
CP0402A0881DN	869 - 894	24.80	0.20	28	20
CP0402A0902DN	890 - 915	24.70	0.20	28	20
CP0402A0947DN	935 - 960	24.10	0.20	28	20
CP0402A0897DN	880 ÷ 915	24.70	0.20	28	20
CP0402A0942DN	925 ÷ 960	24.10	0.20	28	20
CP0402A1441DN	1429 - 1453	20.50	0.20	25	20
CP0402A1747DN	1710 - 1785	19.00	0.20	24	18
CP0402A1842DN	1805 - 1880	18.50	0.25	23	18
CP0402A1880DN	1850 - 1910	18.20	0.25	23	18
CP0402A1960DN	1930 - 1990	18.00	0.25	23	18
CP0402A1907DN	1895 - 1920	18.10	0.25	23	18
CP0402A1890DN	1880 - 1900	18.20	0.25	23	18
CP0402A2442DN	2400 - 2484	16.00	0.35	22	18
CP0402A3500DN	3450 - 3550	12.50	0.46	21	17
CP0402A5000DN	4950 - 5050	10.00	0.65	21	16
CP0402A5500DN	5450 - 5550	9.60	0.76	20	15
CP0402A6000DN	5950 - 6050	9.10	0.84	20	15

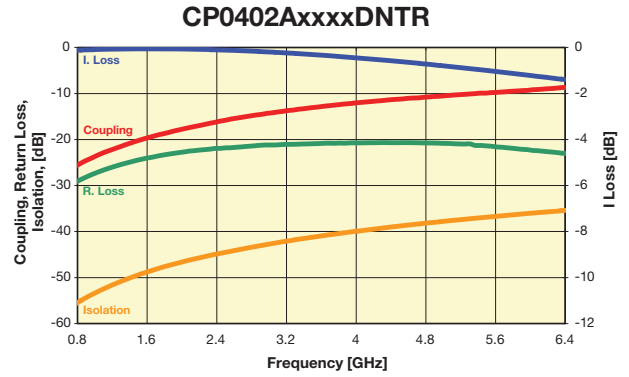

Coupler P/N CP0402AxxxxEN

P/N Examples*	Frequency Band [MHz]	Coupling [dB]	I. Loss max. [dB]	Return Loss [dB]	Directivity [dB]
CP0402A0836EN	824 - 849	25.20	0.20	29	20
CP0402A0881EN	869 - 894	24.80	0.20	28	20
CP0402A0902EN	890 - 915	24.70	0.20	28	20
CP0402A0947EN	935 - 960	24.10	0.20	28	20
CP0402A0897EN	880 ÷ 915	24.70	0.20	28	20
CP0402A0942EN	925 ÷ 960	24.10	0.20	28	20
CP0402A1441EN	1429 - 1453	20.50	0.20	25	20
CP0402A1747EN	1710 - 1785	19.00	0.20	24	18
CP0402A1842EN	1805 - 1880	18.50	0.25	23	18
CP0402A1880EN	1850 - 1910	18.20	0.25	23	18
CP0402A1960EN	1930 - 1990	18.00	0.25	23	18
CP0402A1907EN	1895 - 1920	18.10	0.25	23	18
CP0402A1890EN	1880 - 1900	18.20	0.25	23	18
CP0402A2442EN	2400 - 2484	16.00	0.35	22	18
CP0402A3500EN	3450 - 3550	12.50	0.46	21	17
CP0402A5000EN	4950 - 5050	10.00	0.65	21	16
CP0402A5500EN	5450 - 5550	9.60	0.76	20	15
CP0402A6000EN	5950 - 6050	9.10	0.84	20	15

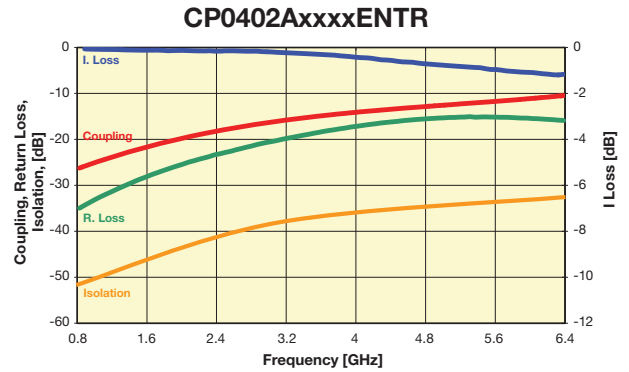

Coupler P/N CP0402AxxxxFN

P/N Examples*	Frequency Band [MHz]	Coupling [dB]	I. Loss max. [dB]	Return Loss [dB]	Directivity [dB]
CP0402A0836FN	824 - 849	31.00	0.20	29.10	11
CP0402A0881FN	869 - 894	30.70	0.20	28.60	11
CP0402A0902FN	890 - 915	30.60	0.20	28.50	11
CP0402A0947FN	935 - 960	30.00	0.20	28.10	11
CP0402A0897FN	880 ÷ 915	30.60	0.20	28.50	11
CP0402A0942FN	925 ÷ 960	30.00	0.20	28.10	11
CP0402A1441FN	1429 - 1453	26.50	0.20	25.00	11
CP0402A1747FN	1710 - 1785	25.00	0.20	23.80	11
CP0402A1842FN	1805 - 1880	24.50	0.20	23.60	11
CP0402A1880FN	1850 - 1910	24.20	0.20	23.50	11
CP0402A1960FN	1930 - 1990	24.00	0.20	23.30	11
CP0402A1907FN	1895 - 1920	24.20	0.20	23.40	11
CP0402A1890FN	1880 - 1900	24.20	0.20	23.50	11
CP0402A2442FN	2400 - 2484	22.00	0.25	22.60	11
CP0402A3500FN	3450 - 3550	18.00	0.27	22.00	9
CP0402A5000FN	4950 - 5050	15.70	0.30	23.01	8
CP0402A5500FN	5450 - 5550	15.20	0.30	20.36	7.5
CP0402A6000FN	5950 - 6050	14.50	0.30	18.94	7.5

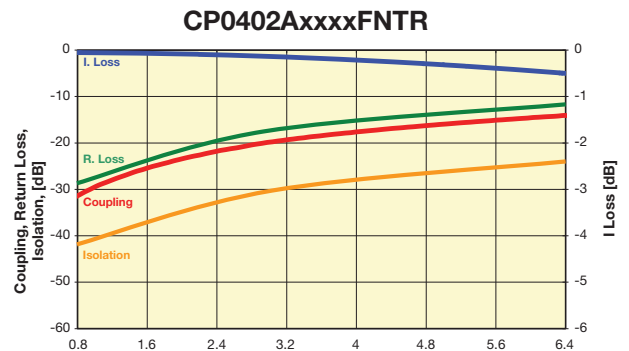

Important: Couplers can be used at any frequency within the indicated range.

Thin-Film RF/Microwave Directional Couplers

CP0302/CP0402/CP0603/CP0805 and DB0603N/DB0805 3dB 90°

CP0603 High Directivity LGA Type



GENERAL DESCRIPTION

ITF (INTEGRATED THIN-FILM) TECHNOLOGY

The ITF LGA Coupler is based on thin-film multilayer technology. The technology provides a miniature part with excellent high frequency performance and rugged construction for reliable automatic assembly.

The ITF Coupler is offered in a variety of frequency bands compatible with various types of high frequency wireless systems.

APPLICATIONS

- 4G LTE
- 5G LTE
- Base Stations.
- Automotive
- Industrial
- Mobile Communications
- Satellite TV Receivers
- GPS
- Vehicle Location Systems
- Wireless LAN's

FEATURES

- Inherent Low Profile
- Self Alignment during Reflow
- Excellent Solderability
- Low Parasitics
- Better Heat Dissipation
- Operating/Storage Temp
-40°C to +85°C
- Power Rating 5W RF Cont

DIMENSIONS: (Bottom View)

millimeters (inches)

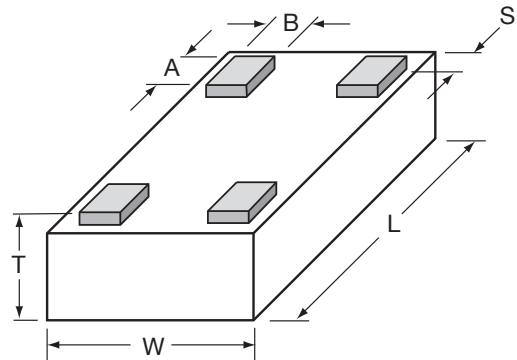

L	1.60±0.10 (0.063±0.004)
W	0.84±0.10 (0.033±0.004)
T	0.60±0.10 (0.024±0.004)

A	0.25±0.05 (0.010±0.002)
B	0.20±0.05 (0.008±0.002)
S	0.05±0.05 (0.002±0.002)

HOW TO ORDER

CP
|
Style
Directional Coupler

0603
|
Size
0603

X
|
Type

|
Frequency
MHz

X
|
Sub-Type

N
|
Termination Code
L = LGA Sn90, Pb10
**N = LGA Sn100

TR
|
Packaging Code
TR = Tape and Reel

**RoHS compliant

QUALITY INSPECTION

Finished parts are 100% tested for electrical parameters and visual characteristics. Each production lot is evaluated on a sample basis for:

- Static Humidity: 85°C, 85% RH, 160 hours
- Endurance: 125°C, I_R, 4 hours

TERMINATION

Sn90Pb10 or Lead-Free Sn100 Nickel/Solder coating compatible with automatic soldering technologies: reflow, wave soldering, vapor phase and manual.

ORIENTATION IN TAPE

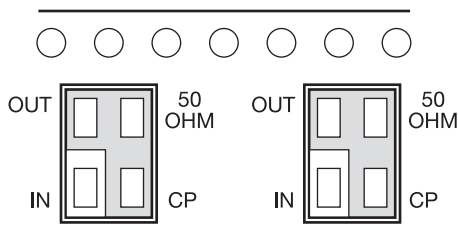

TERMINALS (TOP VIEW)

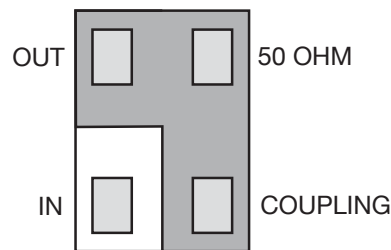

Not RoHS Compliant



LEAD-FREE
LEAD-FREE COMPATIBLE
COMPONENT



RoHS
COMPLIANT

For RoHS compliant products,
please select correct termination style.

Recommended Pad Layout Dimensions

mm (inches)

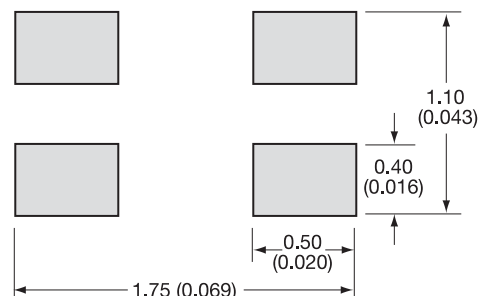

*The recommended distance to the PCB Ground Plane is 0.254mm (0.010")



The Important Information/Disclaimer is incorporated in the catalog where these specifications came from or available online at www.kyocera-avx.com/disclaimer/ by reference and should be reviewed in full before placing any order.

Thin-Film RF/Microwave Directional Couplers
CP0302/CP0402/CP0603/CP0805 and DB0603N/DB0805 3dB 90°
CP0603 High Directivity LGA Type



CP0603 - TYPE SELECTION CHART

Coupling vs. Frequency

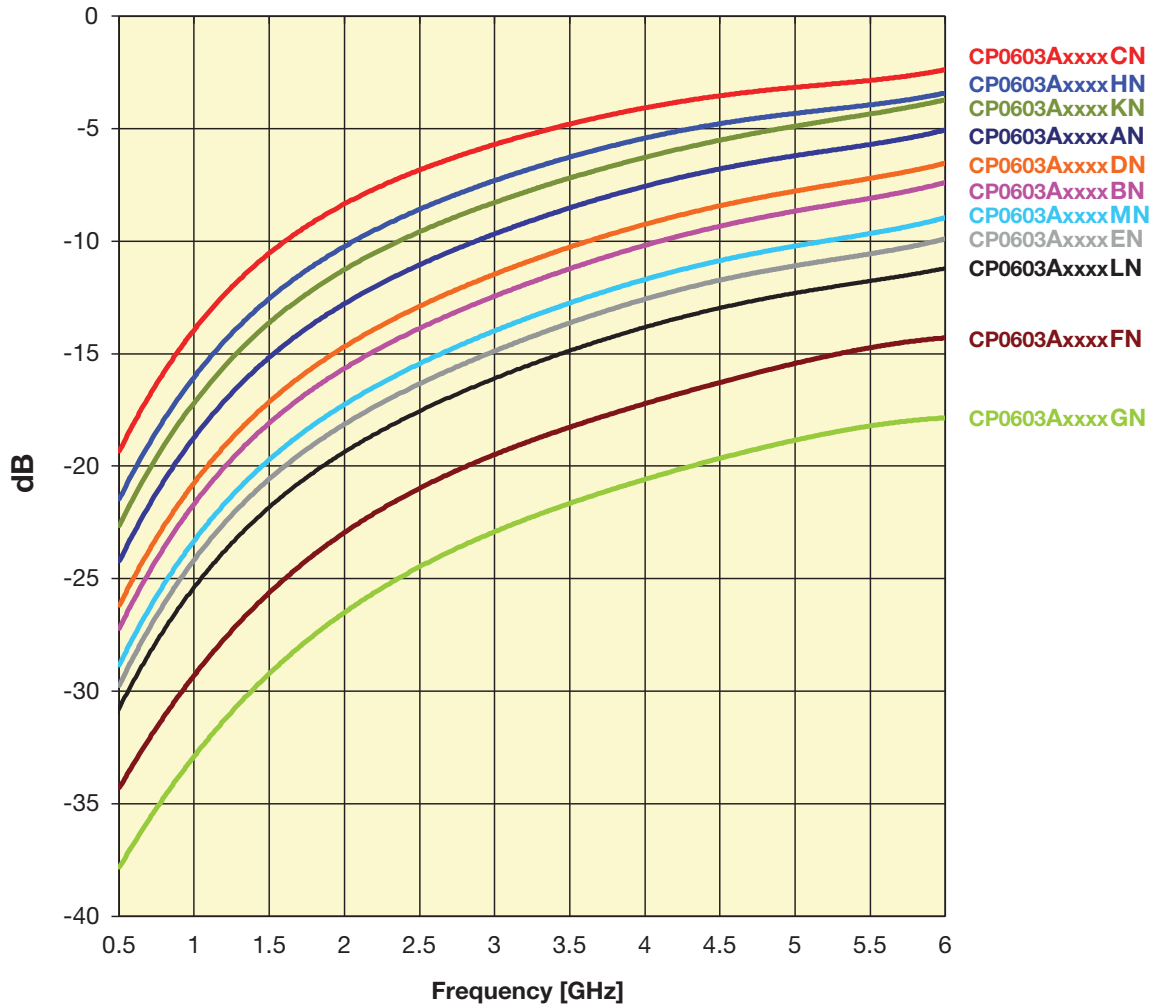

Intermediate coupling factors are readily available.
 Please contact factory.

Thin-Film RF/Microwave Directional Couplers

CP0302/CP0402/CP0603/CP0805 and DB0603N/DB0805 3dB 90°

CP0603 High Directivity LGA Type



Coupler P/N CP0603AxxxxAn

P/N Examples*	Frequency Band [MHz]	Coupling [dB]	I. Loss max. [dB]	Return Loss [dB]	Directivity [dB]
CP0603A0836AN	824 - 849	20.0	0.25	28	22
CP0603A0881AN	869 - 894	19.7	0.25	28	22
CP0603A0902AN	890 - 915	19.4	0.25	27	22
CP0603A0947AN	935 - 960	19.0	0.25	27	22
CP0603A0897AN	880 - 915	19.4	0.25	28	22
CP0603A0942AN	925 - 960	19.0	0.25	27	22
CP0603A1441AN	1429 - 1453	15.5	0.40	24	22
CP0603A1747AN	1710 - 1785	14.0	0.50	22	22
CP0603A1842AN	1805 - 1880	13.5	0.50	22	22
CP0603A1880AN	1850 - 1910	13.2	0.50	22	22
CP0603A1960AN	1930 - 1990	13.0	0.55	21	22
CP0603A1907AN	1895 - 1920	13.2	0.50	22	22
CP0603A1890AN	1880 - 1900	13.2	0.50	22	22
CP0603A2442AN	2400 - 2484	11.5	0.75	20	22
CP0603A3500AN	3450 - 3550	8.6	1.3	17	20
CP0603A5000AN	4950 - 5050	6.1	2.2	13	14
CP0603A5500AN	5450 - 5550	5.5	2.5	15	13
CP0603A6000AN	5950 - 6050	5	3	11.6	13

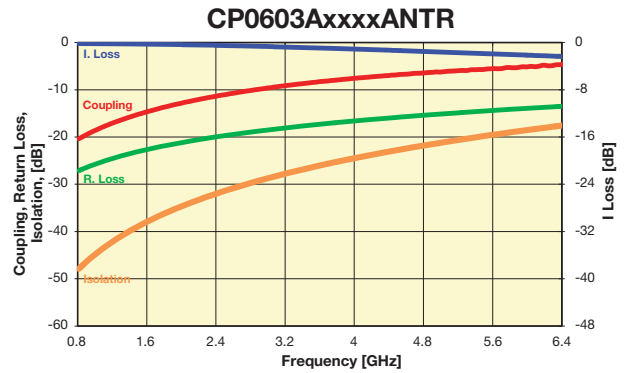

Coupler P/N CP0603AxxxxBN

P/N Examples*	Frequency Band [MHz]	Coupling [dB]	I. Loss max. [dB]	Return Loss [dB]	Directivity [dB]
CP0603A0836BN	824 - 849	23.0	0.20	31	24
CP0603A0881BN	869 - 894	22.7	0.20	31	24
CP0603A0902BN	890 - 915	22.5	0.20	31	24
CP0603A0947BN	935 - 960	22.0	0.20	30	24
CP0603A0897BN	880 - 915	22.5	0.20	31	24
CP0603A0942BN	925 - 960	22.0	0.20	30	24
CP0603A1441BN	1429 - 1453	18.5	0.25	27	24
CP0603A1747BN	1710 - 1785	17.0	0.25	25	21
CP0603A1842BN	1805 - 1880	16.4	0.25	25	21
CP0603A1880BN	1850 - 1910	16.2	0.25	25	21
CP0603A1960BN	1930 - 1990	16.0	0.25	24	21
CP0603A1907BN	1895 - 1920	16.1	0.25	25	21
CP0603A1890BN	1880 - 1900	16.2	0.25	25	21
CP0603A2442BN	2400 - 2484	14.2	0.35	23	21
CP0603A3500BN	3450 - 3550	11.2	0.6	20	20
CP0603A5000BN	4950 - 5050	8.4	1.1	16.7	17
CP0603A5500BN	5450 - 5550	7.8	1.4	15.7	16
CP0603A6000BN	5950 - 6050	7.2	1.6	15	15

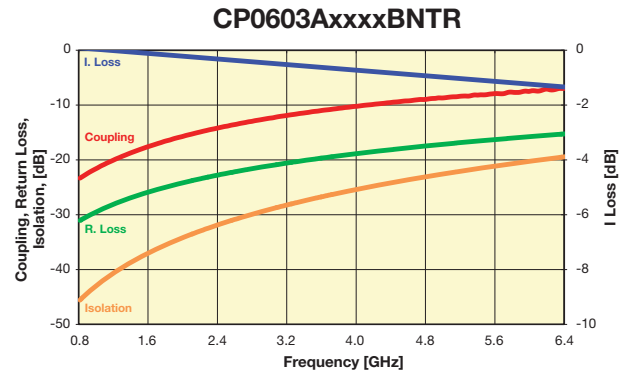

Coupler P/N CP0603AxxxxCN

P/N Examples*	Frequency Band [MHz]	Coupling [dB]	I. Loss max. [dB]	Return Loss [dB]	Directivity [dB]
CP0603A0836CN	824 - 849	15.2	0.35	23	23
CP0603A0881CN	869 - 894	15.0	0.35	23	23
CP0603A0902CN	890 - 915	14.7	0.35	23	23
CP0603A0947CN	935 - 960	14.3	0.40	22	23
CP0603A0897CN	880 - 915	14.7	0.35	23	23
CP0603A0942CN	925 - 960	14.3	0.40	22	23
CP0603A1441CN	1429 - 1453	11.0	0.70	19	23
CP0603A1747CN	1710 - 1785	9.5	0.80	18	21
CP0603A1842CN	1805 - 1880	9.0	0.90	17	21
CP0603A1880CN	1850 - 1910	8.8	0.90	17	21
CP0603A1960CN	1930 - 1990	8.5	1.00	17	21
CP0603A1907CN	1895 - 1920	8.8	0.90	17	21
CP0603A1890CN	1880 - 1900	8.8	0.90	17	21
CP0603A2442CN	2400 - 2484	7.0	1.40	15	21
CP0603A3500CN	3450 - 3550	4.8	2.0	23	20
CP0603A5000CN	4950 - 5050	3.0	3.6	21	17
CP0603A5500CN	5450 - 5550	3.0	4.0	20.6	16
CP0603A6000CN	5950 - 6050	2.5	4.5	20.5	16

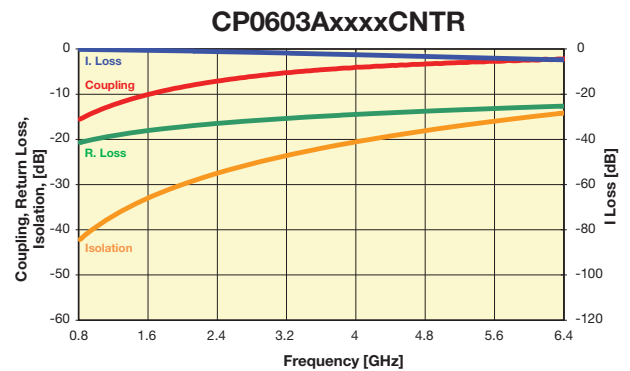

Important: Couplers can be used at any frequency within the indicated range.



The Important Information/Disclaimer is incorporated in the catalog where these specifications came from or available online at www.kyocera-avx.com/disclaimer/ by reference and should be reviewed in full before placing any order.

Thin-Film RF/Microwave Directional Couplers

CP0302/CP0402/CP0603/CP0805 and DB0603N/DB0805 3dB 90°

CP0603 High Directivity LGA Type



Coupler P/N CP0603AxxxxDN

P/N Examples*	Frequency Band [MHz]	Coupling [dB]	I. Loss max. [dB]	Return Loss [dB]	Directivity [dB]
CP0603A0836DN	824 - 849	22.0	0.25	31	30
CP0603A0881DN	869 - 894	21.8	0.25	30	30
CP0603A0902DN	890 - 915	21.3	0.25	30	30
CP0603A0947DN	935 - 960	21.0	0.30	30	30
CP0603A0897DN	880 - 915	21.3	0.25	30	30
CP0603A0942DN	925 - 960	21.0	0.30	30	30
CP0603A1441DN	1429 - 1453	17.7	0.40	27	30
CP0603A1747DN	1710 - 1785	16.0	0.40	25	25
CP0603A1842DN	1805 - 1880	15.4	0.40	25	25
CP0603A1880DN	1850 - 1910	15.2	0.40	24	25
CP0603A1960DN	1930 - 1990	15.0	0.40	24	25
CP0603A1907DN	1895 - 1920	15.2	0.40	24	25
CP0603A1890DN	1880 - 1900	15.2	0.40	24	25
CP0603A2442DN	2400 - 2484	13.3	0.55	22	25
CP0603A3500DN	3450 - 3550	10.1	0.66	25.3	20
CP0603A5000DN	4950 - 5050	7.8	1.17	21.1	18
CP0603A5500DN	5450 - 5550	6.8	1.39	19.9	18
CP0603A6000DN	5950 - 6050	6.3	1.64	18.8	17

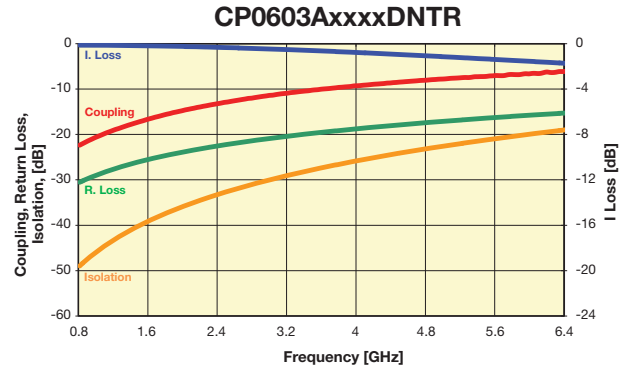

Coupler P/N CP603AxxxxEN

P/N Examples*	Frequency Band [MHz]	Coupling [dB]	I. Loss max. [dB]	Return Loss [dB]	Directivity [dB]
CP0603A0836EN	824 - 849	25.8	0.20	32	21
CP0603A0881EN	869 - 894	25.3	0.20	32	21
CP0603A0902EN	890 - 915	25.0	0.20	32	21
CP0603A0947EN	935 - 960	24.7	0.20	31	21
CP0603A0897EN	880 - 915	26.0	0.20	32	21
CP0603A0942EN	925 - 960	24.7	0.20	31	21
CP0603A1441EN	1429 - 1453	22.0	0.25	28	21
CP0603A1747EN	1710 - 1785	19.5	0.30	26	21
CP0603A1842EN	1805 - 1880	19.0	0.30	26	21
CP0603A1880EN	1850 - 1910	18.8	0.30	26	21
CP0603A1960EN	1930 - 1990	18.5	0.30	26	21
CP0603A1907EN	1895 - 1920	18.7	0.30	26	21
CP0603A1890EN	1880 - 1900	18.8	0.30	26	21
CP0603A2442EN	2400 - 2484	17.0	0.40	24	21
CP0603A3500EN	3450 - 3550	13.2	0.5	18	20
CP0603A5000EN	4950 - 5050	10.7	0.9	13	16
CP0603A5500EN	5450 - 5550	10.2	1.2	12	15
CP0603A6000EN	5950 - 6050	9.7	1.4	12	14

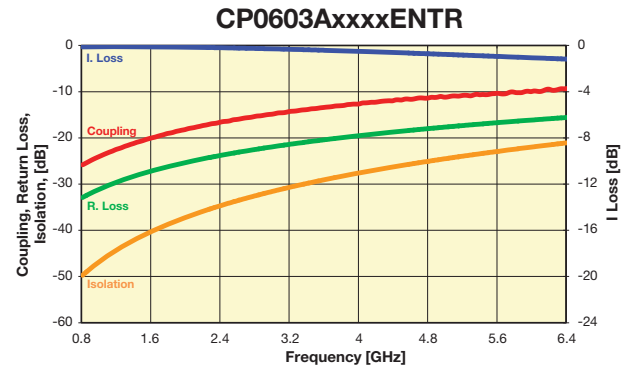

Coupler P/N CP603AxxxxFN

P/N Examples*	Frequency Band [MHz]	Coupling [dB]	I. Loss max. [dB]	Return Loss [dB]	Directivity [dB]
CP0603A0836FN	824 - 849	31.2	0.20	32	12
CP0603A0881FN	869 - 894	30.8	0.20	32	12
CP0603A0902FN	890 - 915	30.5	0.20	30	12
CP0603A0947FN	935 - 960	30.2	0.20	30	12
CP0603A0897FN	880 - 915	30.5	0.20	30	12
CP0603A0942FN	925 - 960	30.2	0.20	30	12
CP0603A1441FN	1429 - 1453	27.0	0.25	28	12
CP0603A1747FN	1710 - 1785	25.0	0.25	27	12
CP0603A1842FN	1805 - 1880	26.5	0.25	27	12
CP0603A1880FN	1850 - 1910	24.3	0.25	27	12
CP0603A1960FN	1930 - 1990	24.0	0.25	28	12
CP0603A1907FN	1895 - 1920	24.2	0.25	27	12
CP0603A1890FN	1880 - 1900	24.2	0.25	27	12
CP0603A2442FN	2400 - 2484	21.5	0.25	25	12
CP0603A3500FN	3450 - 3550	17.8	0.33	20.0	13
CP0603A5000FN	4950 - 5050	15.4	0.62	14.86	12
CP0603A5500FN	5450 - 5550	14.8	0.86	13.58	12
CP0603A6000FN	5950 - 6050	14.3	1.02	12.58	11

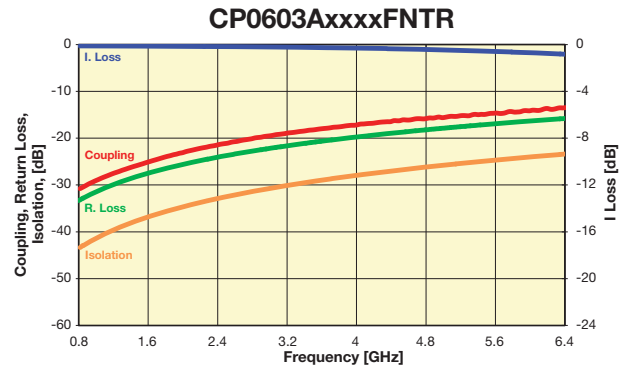

Important: Couplers can be used at any frequency within the indicated range.

Thin-Film RF/Microwave Directional Couplers

CP0302/CP0402/CP0603/CP0805 and DB0603N/DB0805 3dB 90°

CP0603 High Directivity LGA Type



Coupler P/N CP603AxxxxGN

P/N Examples*	Frequency Band [MHz]	Coupling [dB]	I. Loss max. [dB]	Return Loss [dB]	Directivity [dB]
CP0603A0836GN	824 - 849	34.2	0.20	30	13
CP0603A0881GN	869 - 894	33.8	0.20	30	13
CP0603A0902GN	890 - 915	33.6	0.20	30	13
CP0603A0947GN	935 - 960	33.2	0.20	29	13
CP0603A0897GN	880 - 915	33.6	0.20	30	13
CP0603A0942GN	925 - 960	33.2	0.20	29	13
CP0603A1441GN	1429 - 1453	30.0	0.25	25	13
CP0603A1747GN	1710 - 1785	28.5	0.25	24	13
CP0603A1842GN	1805 - 1880	28.0	0.25	24	13
CP0603A1880GN	1850 - 1910	27.7	0.25	24	13
CP0603A1960GN	1930 - 1990	27.5	0.25	23	13
CP0603A1907GN	1895 - 1920	27.6	0.25	24	13
CP0603A1890GN	1880 - 1900	27.7	0.25	24	13
CP0603A2442GN	2400 - 2484	25.5	0.25	22	13
CP0603A3500GN	3450 - 3550	21.6	0.31	20	13
CP0603A5000GN	4950 - 5050	19	0.39	16	12
CP0603A5500GN	5450 - 5550	18.5	0.57	15	12
CP0603A6000GN	5950 - 6050	18.0	0.74	14	11

CP0603AxxxxGNTR

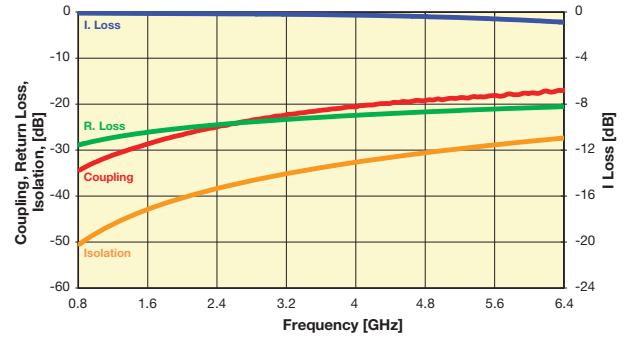

Coupler P/N CP603AxxxxHN

P/N Examples*	Frequency Band [MHz]	Coupling [dB]	I. Loss max. [dB]	Return Loss [dB]	Directivity [dB]
CP0603A0836HN	824 - 849	17.3	0.30	26	26
CP0603A0881HN	869 - 894	17.0	0.30	25	26
CP0603A0902HN	890 - 915	16.7	0.30	25	26
CP0603A0947HN	935 - 960	16.3	0.35	25	26
CP0603A0897HN	880 - 915	17.0	0.35	25	26
CP0603A0942HN	925 - 960	16.3	0.35	25	26
CP0603A1441HN	1429 - 1453	13.0	0.55	22	26
CP0603A1747HN	1710 - 1785	11.4	0.75	20	24
CP0603A1842HN	1805 - 1880	11.0	0.75	20	24
CP0603A1880HN	1850 - 1910	10.8	0.75	19	24
CP0603A1960HN	1930 - 1990	10.5	0.75	19	24
CP0603A1907HN	1895 - 1920	10.7	0.75	19	24
CP0603A1890HN	1880 - 1900	10.8	0.75	19	24
CP0603A2442HN	2400 - 2484	8.8	1.00	17	24
CP0603A3500HN	3450 - 3550	5.9	1.48	25	21
CP0603A5000HN	4950 - 5050	4.4	2.59	22	18
CP0603A5500HN	5450 - 5550	4	2.95	22	17
CP0603A6000HN	5950 - 6050	3.5	3.37	21	17

CP0603AxxxxHNTR

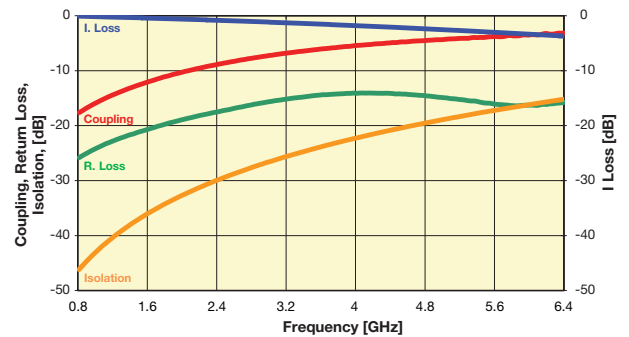

Coupler P/N CP603AxxxxMN

P/N Examples*	Frequency Band [MHz]	Coupling [dB]	I. Loss max. [dB]	Return Loss [dB]	Directivity [dB]
CP0603A0836MN	824 - 849	24.2	0.20	33	23
CP0603A0881MN	869 - 894	23.8	0.20	32	23
CP0603A0902MN	890 - 915	23.4	0.20	32	23
CP0603A0947MN	935 - 960	23.2	0.20	32	23
CP0603A0897MN	880 - 915	23.4	0.20	32	23
CP0603A0942MN	925 - 960	23.2	0.20	32	23
CP0603A1441MN	1429 - 1453	20.0	0.25	28	23
CP0603A1747MN	1710 - 1785	18.4	0.25	27	20
CP0603A1842MN	1805 - 1880	18.0	0.25	26	20
CP0603A1880MN	1850 - 1910	17.8	0.25	26	20
CP0603A1960MN	1930 - 1990	17.5	0.25	26	20
CP0603A1907MN	1895 - 1920	17.7	0.25	26	20
CP0603A1890MN	1880 - 1900	17.8	0.25	26	20
CP0603A2442MN	2400 - 2484	15.6	0.35	24	20
CP0603A3500MN	3450 - 3550	12.8	0.58	18	20
CP0603A5000MN	4950 - 5050	10.2	1.0	15	16
CP0603A5500MN	5450 - 5550	9.7	1.2	15	14
CP0603A6000MN	5950 - 6050	8.9	1.5	13.5	9

CP0603AxxxxMNTR

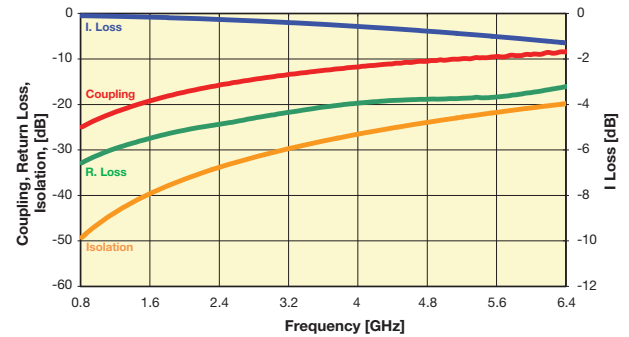

Important: Couplers can be used at any frequency within the indicated range.



The Important Information/Disclaimer is incorporated in the catalog where these specifications came from or available online at www.kyocera-avx.com/disclaimer/ by reference and should be reviewed in full before placing any order.

Thin-Film RF/Microwave Directional Couplers

CP0302/CP0402/CP0603/CP0805 and DB0603N/DB0805 3dB 90°

CP0603 High Directivity LGA Type



Coupler P/N CP603AxxxxLN

P/N Examples*	Frequency Band [MHz]	Coupling [dB]	I. Loss max. [dB]	Return Loss [dB]	Directivity [dB]
CP0603A0836LN	824 - 849	26.89	0.08	32.5	18
CP0603A0881LN	869 - 894	26.55	0.08	32.2	18
CP0603A0902LN	890 - 915	26.2	0.09	31.9	18
CP0603A0947LN	935 - 960	25.87	0.09	31.5	18
CP0603A0897LN	880 - 915	26.2	0.09	31.9	18
CP0603A0942LN	925 - 960	25.87	0.09	31.5	18
CP0603A1441LN	1429 - 1453	22.31	0.12	28.1	17.5
CP0603A1747LN	1710 - 1785	20.51	0.15	26.4	16.5
CP0603A1842LN	1805 - 1880	20.03	0.15	26	16.5
CP0603A1880LN	1850 - 1910	19.87	0.16	26	16.5
CP0603A1960LN	1930 - 1990	19.57	0.17	25.5	16.5
CP0603A1907LN	1895 - 1920	19.77	0.16	25.7	16.5
CP0603A1890LN	1880 - 1900	19.87	0.16	25.8	16.5
CP0603A2442LN	2400 - 2484	17.7	0.22	23.9	16.5
CP0603A3500LN	3450 - 3550	14.85	0.56	20.6	16
CP0603A5000LN	4950 - 5050	12.4	0.95	17.8	11
CP0603A5500LN	5450 - 5550	11.83	1.2	17.1	9
CP0603A6000LN	5950 - 6050	11.08	1.33	15.9	9

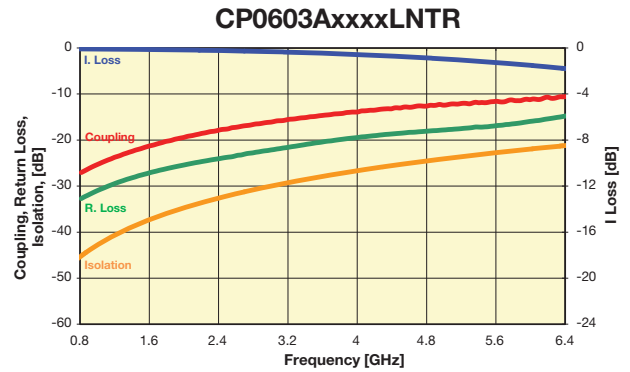

Coupler P/N CP603AxxxxKN

P/N Examples*	Frequency Band [MHz]	Coupling [dB]	I. Loss max. [dB]	Return Loss [dB]	Directivity [dB]
CP0603A0836KN	824 - 849	18.5	0.14	30	26
CP0603A0881KN	869 - 894	18.1	0.14	29	26
CP0603A0902KN	890 - 915	17.6	0.15	29	26
CP0603A0947KN	935 - 960	17.3	0.15	29	25
CP0603A0897KN	880 - 915	17.9	0.147	29	25
CP0603A0942KN	925 - 960	17.6	0.15	29	25
CP0603A1441KN	1429 - 1453	14	0.27	25	25
CP0603A1747KN	1710 - 1785	12.4	0.36	23	24
CP0603A1842KN	1805 - 1880	12	0.39	22.5	24
CP0603A1880KN	1850 - 1910	11.8	0.4	22	24
CP0603A1960KN	1930 - 1990	11.4	0.44	22	24
CP0603A1907KN	1895 - 1920	11.5	0.43	22	24
CP0603A1890KN	1880 - 1900	11.7	0.41	22	24
CP0603A2442KN	2400 - 2484	9.7	0.6	19	23
CP0603A3500KN	3450 - 3550	7.2	1.15	15	19
CP0603A5000KN	4950 - 5050	4.7	2.15	15	13
CP0603A5500KN	5450 - 5550	4.2	2.5	17	13
CP0603A6000KN	5950 - 6050	3.7	2.8	19	13

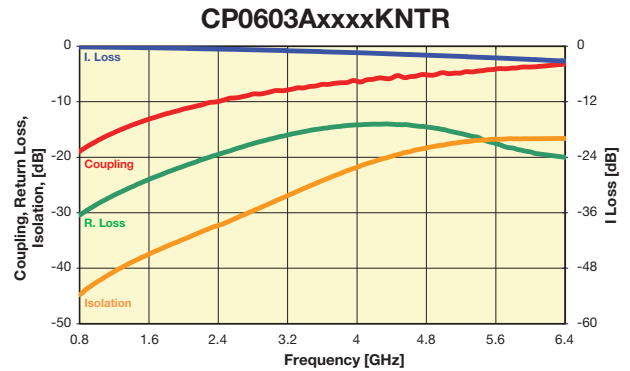

Important: Couplers can be used at any frequency within the indicated range.

Thin-Film RF/Microwave Directional Couplers

CP0302/CP0402/CP0603/CP0805 and DB0603N/DB0805 3dB 90°

CP0402 / CP0603 High Directivity Couplers Test Jigs

GENERAL DESCRIPTION

These jigs are designed for testing the CP0402 and CP0603 High Directivity Couplers using a Vector Network Analyzer.

They consist of a dielectric substrate, having 50Ω microstrips as conducting lines and a bottom ground plane located at a distance of 0.254mm (0.010") from the microstrips.

The substrate used is Neltec's NH9338ST0254C1BC.

The connectors are SMA type (female), 'Johnson Components Inc.' Product P/N: 142-0701-841.

Both a measurement jig and a calibration jig are provided.

The calibration jig is designed for a full 2-port calibration, and consists of an open line, short line and through line. LOAD calibration can be done by a 50Ω SMA termination.

MEASUREMENT PROCEDURE

When measuring a component, it can be either soldered or pressed using a non-metallic stick until all four ports touch the appropriate pads. Set the VNA to the relevant frequency band. Connect the VNA using a 10dB attenuator on the jig terminal connected to port 2. Follow the VNA's instruction manual and use the [calibration jig](#) to perform a full 2-Port

calibration in the required bandwidths.

Place the coupler on the **measurement jig** as follows:

Input (Coupler)	↗	Connector 1 (Jig)	Termination (Coupler)	↗	Connector 3 (Jig)
Output (Coupler)	↘	Connector 2 (Jig)	Coupling (Coupler)	↘	Connector 4 (Jig)

To measure I. Loss connect:

Connector 1 (Jig)	↗	Port 1 (VNA)	Connector 3 (Jig)	↗	50Ω
Connector 2 (Jig)	↘	Port 2 (VNA)	Connector 4 (Jig)	↘	50Ω

To measure R. Loss and Coupling connect:

Connector 1 (Jig)	↗	Port 1 (VNA)	Connector 3 (Jig)	↗	50Ω
Connector 2 (Jig)	↘	50Ω	Connector 4 (Jig)	↘	Port 2 (VNA)

To measure Isolation connect:

Connector 1 (Jig)	↗	50Ω	Connector 3 (Jig)	↗	50Ω
Connector 2 (Jig)	↘	Port 1 (VNA)	Connector 4 (Jig)	↘	Port 2 (VNA)

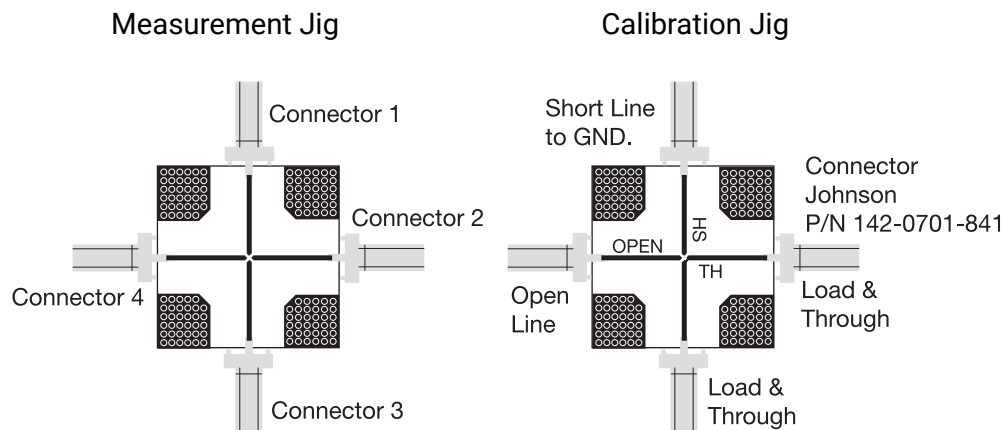



Thin-Film RF/Microwave Products

LGA Coupler Designer Kit 0402/0603 Size

Thin-Film RF/Microwave Directional Couplers

LGA Couplers Design Kits

DESIGNER KIT

TYPE: 2300LF

ORDER NUMBER: KITCN20402SP3K

1	CP0402AxxxxAN	20 Pcs
2	CP0402AxxxxBN	20 Pcs
3	CP0402AxxxxCN	20 Pcs
4	CP0402AxxxxDN	20 Pcs
5	CP0402AxxxxEN	20 Pcs
6	CP0402AxxxxFN	20 Pcs
7	CP0603AxxxxAN	20 Pcs
8	CP0603AxxxxBN	20 Pcs
9	CP0603AxxxxCN	20 Pcs
10	CP0603AxxxxDN	20 Pcs
11	CP0603AxxxxEN	20 Pcs
12	CP0603AxxxxFN	20 Pcs
13	CP0603AxxxxGN	20 Pcs
14	CP0603AxxxxHN	20 Pcs
15	CP0603AxxxxMN	20 Pcs

Thin-Film RF/Microwave Directional Couplers

CP0302/CP0402/CP0603/CP0805 and DB0603N/DB0805 3dB 90°

CP0603 SMD Type



GENERAL DESCRIPTION

ITF (INTEGRATED THIN-FILM) TECHNOLOGY

The ITF SMD Coupler is based on thin-film multilayer technology. The technology provides a miniature part with excellent high frequency performance and rugged construction for reliable automatic assembly.

The ITF Coupler is offered in a variety of frequency bands compatible with various types of high frequency wireless systems.

APPLICATIONS

- 4G LTE
- 5G LTE
- Base Stations.
- Automotive
- Industrial
- Mobile Communications
- Satellite TV Receivers
- GPS
- Vehicle Location Systems
- Wireless LAN's

FEATURES

- Miniature Size: 0603
- Frequency Range: 800MHz - 3GHz
- Characteristic Impedance: 50Ω
- Operating / Storage Temp.: -40°C to +85°C
- Power Rating: 3W Continuous
- Low Profile
- Rugged Construction
- Taped and Reeled

DIMENSIONS:

millimeters (inches)

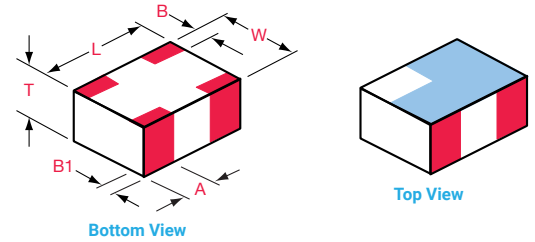

	0603
L	1.6±0.1 (0.063±0.004)
W	0.84±0.1 (0.033±0.004)
T	0.60±0.1 (0.028±0.004)
A	0.35±0.15 (0.014±0.006)
B	0.175±0.1 (0.007±0.004)
B1	0.00±0.1/0-0.0 (0.00±0.004/-0.0)

HOW TO ORDER

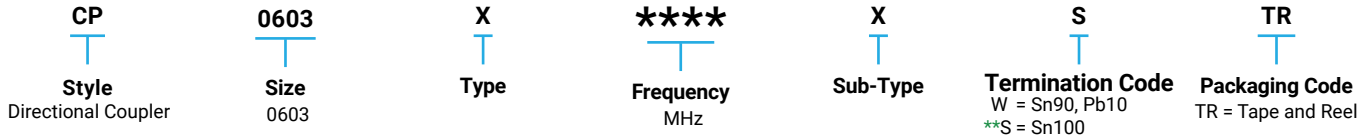

**RoHS compliant

QUALITY INSPECTION

Finished parts are 100% tested for electrical parameters and visual characteristics. Each production lot is evaluated on a sample basis for:

- Static Humidity: 85°C, 85% RH, 160 hours
- Endurance: 125°C, I_R, 4 hours

TERMINATION

Nickel/Solder coating compatible with automatic soldering technologies: reflow, wave soldering, vapor phase and manual.

Recommended Pad Layout Dimensions mm (inches)

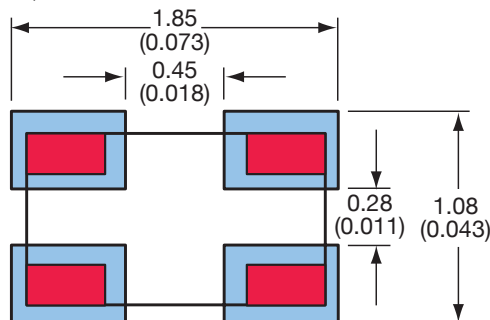

TERMINALS (TOP VIEW)

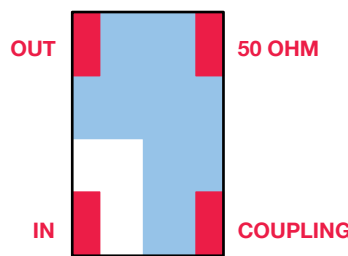

Not RoHS Compliant



LEAD-FREE
LEAD-FREE COMPATIBLE
COMPONENT



RoHS
COMPLIANT

For RoHS compliant products,
please select correct termination style.

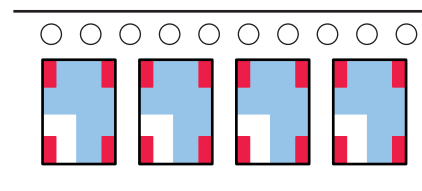

Orientation in tape

Thin-Film RF/Microwave Directional Couplers

CP0302/CP0402/CP0603/CP0805 and DB0603N/DB0805 3dB 90°

CP0603 SMD Type



Coupler P/N CP0603A****AS

P/N Examples	Frequency Band [MHz]	Coupling [dB]	I. Loss max	VSWR max
CP0603A0836AS	824 - 849	18.5±1	0.25	1.2
CP0603A0881AS	869 - 894	18.5±1	0.25	1.2
CP0603A0902AS	890 - 915	18±1	0.25	1.2
CP0603A0947AS	935 - 960	17.5±1	0.25	1.2
CP0603A0897AS	880 - 915	18±1	0.25	1.2
CP0603A0942AS	925 - 960	17.5±1	0.25	1.2
CP0603A1441AS	1429 - 1453	14±1	0.4	1.2
CP0603A1747AS	1710 - 1785	12.5±1	0.6	1.2
CP0603A1842AS	1805 - 1880	12±1	0.6	1.2
CP0603A1880AS	1850 - 1910	12±1	0.6	1.2
CP0603A1960AS	1930 - 1990	11.5±1	0.65	1.2
CP0603A1907AS	1895 - 1920	12±1	0.6	1.2
CP0603A1890AS	1880 - 1900	12±1	0.6	1.2
CP0603A2442AS	2400 - 2484	10±1	0.85	1.2

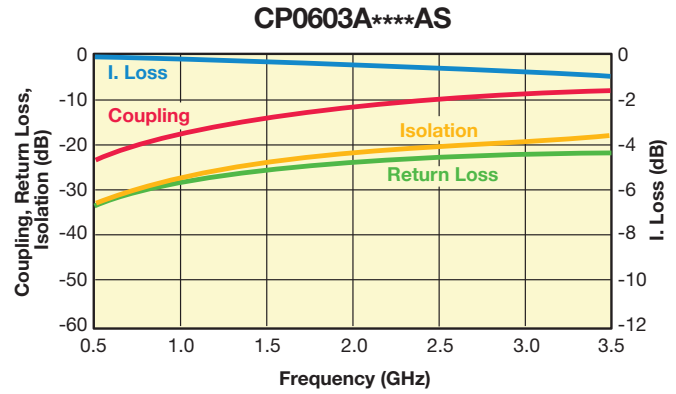

Coupler P/N CP0603A****BS

P/N Examples	Frequency Band [MHz]	Coupling [dB]	I. Loss max	VSWR max
CP0603A0836BS	824 - 849	16±1	0.25	1.2
CP0603A0881BS	869 - 894	15.5±1	0.25	1.2
CP0603A0902BS	890 - 915	15.5±1	0.25	1.2
CP0603A0947BS	935 - 960	15±1	0.25	1.2
CP0603A0897BS	880 - 915	15.5±1	0.25	1.2
CP0603A0942BS	925 - 960	15±1	0.25	1.2
CP0603A1441BS	1429 - 1453	11.5±1	0.55	1.2
CP0603A1747BS	1710 - 1785	10±1	0.8	1.3
CP0603A1842BS	1805 - 1880	9.5±1	0.8	1.3
CP0603A1880BS	1850 - 1910	9±1	0.8	1.4
CP0603A1960BS	1930 - 1990	9±1	0.8	1.4
CP0603A1907BS	1895 - 1920	9±1	0.8	1.4
CP0603A1890BS	1880 - 1900	9±1	0.8	1.4
CP0603A2442BS	2400 - 2484	7.5±1	1.1	1.4

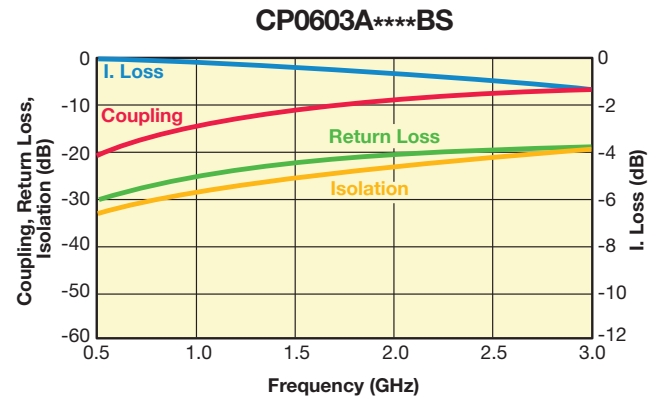

Coupler P/N CP0603A****CS

P/N Examples	Frequency Band [MHz]	Coupling [dB]	I. Loss max	VSWR max
CP0603A0836CS	824 - 849	21±1	0.25	1.2
CP0603A0881CS	869 - 894	20.5±1	0.25	1.2
CP0603A0902CS	890 - 915	20.5±1	0.25	1.2
CP0603A0947CS	935 - 960	20±1	0.25	1.2
CP0603A0897CS	880 - 915	20.5±1	0.25	1.2
CP0603A0942CS	925 - 960	20±1	0.25	1.2
CP0603A1441CS	1429 - 1453	16.5±1	0.55	1.2
CP0603A1747CS	1710 - 1785	15±1	0.8	1.2
CP0603A1842CS	1805 - 1880	14.5±1	0.8	1.2
CP0603A1880CS	1850 - 1910	14.5±1	0.8	1.2
CP0603A1960CS	1930 - 1990	14±1	0.8	1.2
CP0603A1907CS	1895 - 1920	14.5±1	0.8	1.2
CP0603A1890CS	1880 - 1900	14.5±1	0.8	1.2
CP0603A2442CS	2400 - 2484	12.5±1	1.1	1.2

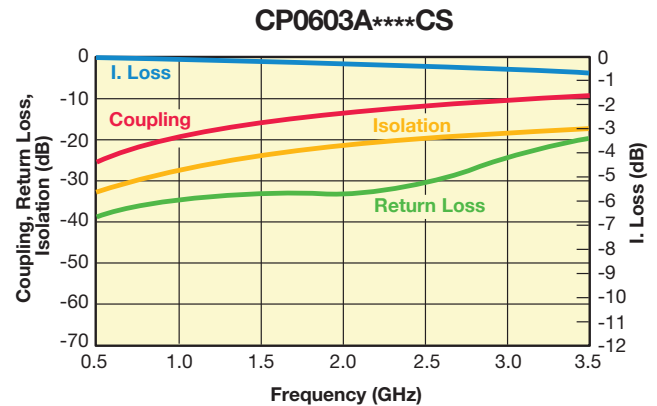

Coupler P/N CP0603A****DS

P/N Examples	Frequency Band [MHz]	Coupling [dB]	I. Loss max	VSWR max
CP0603A0836DS	824 - 849	15.0±1	0.25	1.2
CP0603A0881DS	869 - 894	14.5±1	0.25	1.2
CP0603A0902DS	890 - 915	14.5±1	0.25	1.2
CP0603A0947DS	935 - 960	14±1	0.25	1.2
CP0603A0897DS	880 - 915	14.5±1	0.25	1.2
CP0603A0942DS	925 - 960	14±1	0.25	1.2
CP0603A1441DS	1429 - 1453	10.5±1	0.7	1.3
CP0603A1747DS	1710 - 1785	9±1	0.9	1.5
CP0603A1842DS	1805 - 1880	8.5±1	0.9	1.5
CP0603A1880DS	1850 - 1910	8.5±1	1.0	1.5
CP0603A1960DS	1930 - 1990	8±1	1.0	1.5
CP0603A1907DS	1895 - 1920	8.5±1	1.0	1.5
CP0603A1890DS	1880 - 1900	8.5±1	1.0	1.5
CP0603A2442DS	2400 - 2484	6.5±1	1.5	1.5

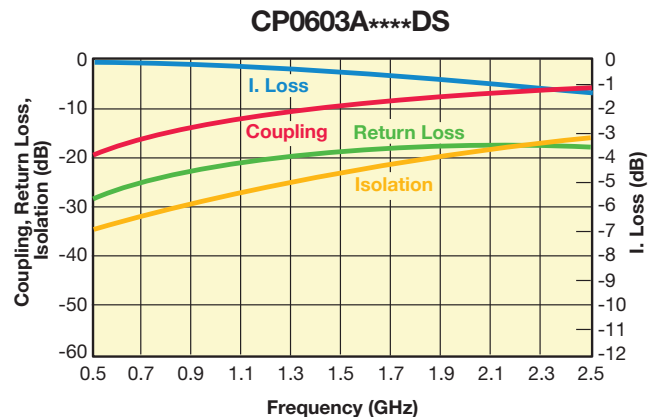

Important: Couplers can be used at any frequency within the indicated range.



The Important Information/Disclaimer is incorporated in the catalog where these specifications came from or available online at www.kyocera-avx.com/disclaimer/ by reference and should be reviewed in full before placing any order.

Thin-Film RF/Microwave Directional Couplers

CP0302/CP0402/CP0603/CP0805 and DB0603N/DB0805 3dB 90°

CP0603 SMD Type



Coupler P/N CP0603B****AS

P/N Examples	Frequency Band [MHz]	Coupling [dB]	I. Loss max	VSWR max
CP0603B0836AS	824 - 849	24.5±1	0.2	1.2
CP0603B0881AS	869 - 894	24±1	0.2	1.2
CP0603B0902AS	890 - 915	24±1	0.2	1.2
CP0603B0947AS	935 - 960	23.5±1	0.2	1.2
CP0603B0897AS	880 - 915	24±1	0.2	1.2
CP0603B0942AS	925 - 960	23.5±1	0.2	1.2
CP0603B1441AS	1429 - 1453	20±1	0.25	1.2
CP0603B1747AS	1710 - 1785	18±1	0.25	1.2
CP0603B1842AS	1805 - 1880	17.5±1	0.3	1.2
CP0603B1880AS	1850 - 1910	17.5±1	0.3	1.2
CP0603B1960AS	1930 - 1990	17.5±1	0.3	1.2
CP0603B1907AS	1895 - 1920	17.5±1	0.3	1.2
CP0603B1890AS	1880 - 1900	17.5±1	0.3	1.2
CP0603B2442AS	2400 - 2484	15.5±1	0.45	1.2

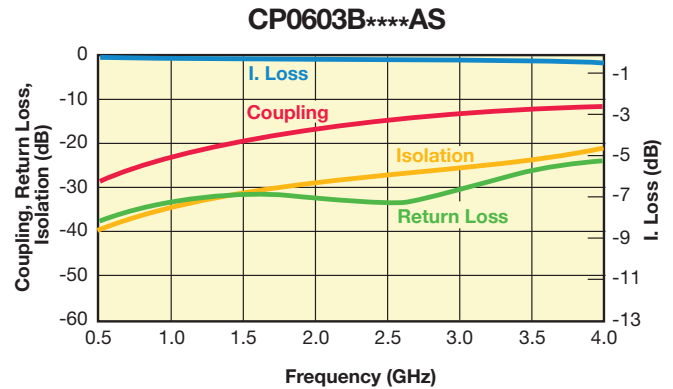

Coupler P/N CP0603B****BS

P/N Examples	Frequency Band [MHz]	Coupling [dB]	I. Loss max	VSWR max
CP0603B0836BS	824 - 849	25.5±1	0.2	1.2
CP0603B0881BS	869 - 894	25±1	0.2	1.2
CP0603B0902BS	890 - 915	25±1	0.2	1.2
CP0603B0947BS	935 - 960	24.5±1	0.2	1.2
CP0603B0897BS	880 - 915	25±1	0.2	1.2
CP0603B0942BS	925 - 960	24.5±1	0.2	1.2
CP0603B1441BS	1429 - 1453	21±1	0.2	1.2
CP0603B1747BS	1710 - 1785	19±1	0.25	1.2
CP0603B1842BS	1805 - 1880	19±1	0.25	1.2
CP0603B1880BS	1850 - 1910	18.5±1	0.25	1.2
CP0603B1960BS	1930 - 1990	18.5±1	0.25	1.2
CP0603B1907BS	1895 - 1920	18.5±1	0.25	1.2
CP0603B1890BS	1880 - 1900	18.5±1	0.25	1.2
CP0603B2442BS	2400 - 2484	16.5±1	0.35	1.2

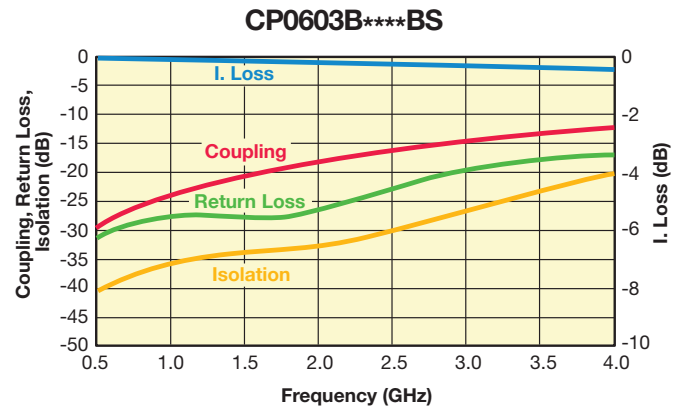

Coupler P/N CP0603B****CS

P/N Examples	Frequency Band [MHz]	Coupling [dB]	I. Loss max	VSWR max
CP0603B0836CS	824 - 849	26.5±1	0.2	1.2
CP0603B0881CS	869 - 894	26±1	0.2	1.2
CP0603B0902CS	890 - 915	26±1	0.2	1.2
CP0603B0947CS	935 - 960	25.5±1	0.2	1.2
CP0603B0897CS	880 - 915	26±1	0.2	1.2
CP0603B0942CS	925 - 960	25.5±1	0.2	1.2
CP0603B1441CS	1429 - 1453	22±1	0.2	1.2
CP0603B1747CS	1710 - 1785	20.5±1	0.25	1.2
CP0603B1842CS	1805 - 1880	20±1	0.25	1.2
CP0603B1880CS	1850 - 1910	20±1	0.25	1.2
CP0603B1960CS	1930 - 1990	19.5±1	0.25	1.2
CP0603B1907CS	1895 - 1920	20±1	0.25	1.2
CP0603B1890CS	1880 - 1900	20±1	0.25	1.2
CP0603B2442CS	2400 - 2484	18±1	0.35	1.3

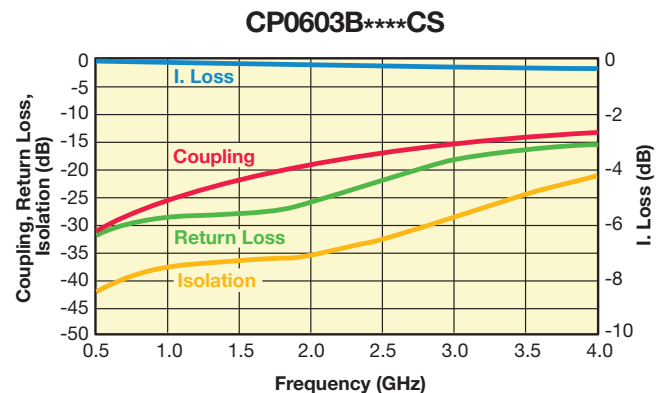

Important: Couplers can be used at any frequency within the indicated range.

Thin-Film RF/Microwave Directional Couplers

CP0302/CP0402/CP0603/CP0805 and DB0603N/DB0805 3dB 90°

CP0603 SMD Type – High Directivity



Coupler P/N CP0603D**AS**

P/N Examples	Frequency Band [MHz]	Coupling [dB]	I. Loss max. [dB]	Return Loss [dB]	Directivity [dB]
CP0603D0836AS	824 - 849	13.50	0.50	23	21
CP0603D0881AS	869 - 894	13.00	0.50	22	21
CP0603D0902AS	890 - 915	13.00	0.50	22	21
CP0603D0947AS	935 - 960	12.50	0.50	22	21
CP0603D0897AS	880 - 915	13.00	0.50	22	21
CP0603D0942AS	925 - 960	12.50	0.50	22	21
CP0603D1441AS	1429 - 1453	9.00	1.00	18	19
CP0603D1747AS	1710 - 1785	8.00	1.40	17	18
CP0603D1842AS	1805 - 1880	7.50	1.40	17	17
CP0603D1880AS	1850 - 1910	7.50	1.40	16	17
CP0603D1960AS	1930 - 1990	7.00	1.40	16	17
CP0603D1907AS	1895 - 1920	7.00	1.40	16	17
CP0603D1890AS	1880 - 1900	7.00	1.40	16	17
CP0603D2442AS	2400 - 2484	5.50	2.00	15	15

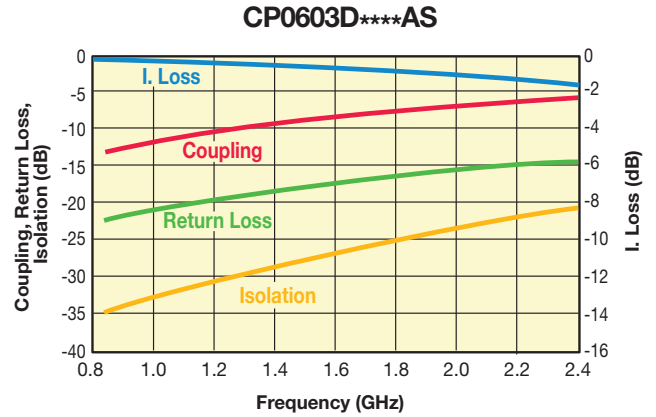

Coupler P/N CP0603D**BS**

P/N Examples	Frequency Band [MHz]	Coupling [dB]	I. Loss max. [dB]	Return Loss [dB]	Directivity [dB]
CP0603D0836BS	824 - 849	20.00	0.25	36	19
CP0603D0881BS	869 - 894	19.50	0.25	36	19
CP0603D0902BS	890 - 915	19.50	0.25	35	19
CP0603D0947BS	935 - 960	19.00	0.25	36	19
CP0603D0897BS	880 - 915	19.50	0.25	36	19
CP0603D0942BS	925 - 960	19.00	0.25	35	19
CP0603D1441BS	1429 - 1453	15.50	0.40	30	19
CP0603D1747BS	1710 - 1785	14.00	0.50	28	19
CP0603D1842BS	1805 - 1880	13.50	0.55	27	19
CP0603D1880BS	1850 - 1910	13.50	0.55	27	19
CP0603D1960BS	1930 - 1990	13.50	0.55	27	19
CP0603D1907BS	1895 - 1920	13.00	0.55	27	19
CP0603D1890BS	1880 - 1900	13.00	0.55	27	19
CP0603D2442BS	2400 - 2484	11.00	0.70	24	19

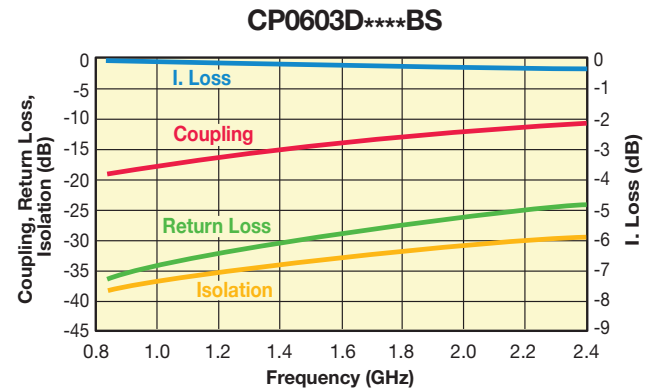

Important: Couplers can be used at any frequency within the indicated range.



The Important Information/Disclaimer is incorporated in the catalog where these specifications came from or available online at www.kyocera-avx.com/disclaimer/ by reference and should be reviewed in full before placing any order.

Thin-Film RF/Microwave Directional Couplers

CP0302/CP0402/CP0603/CP0805 and DB0603N/DB0805 3dB 90°

CP0805 SMD Type



GENERAL DESCRIPTION

ITF (INTEGRATED THIN-FILM) TECHNOLOGY

The ITF SMD Coupler is based on thin-film multilayer technology. The technology provides a miniature part with excellent high frequency performance and rugged construction for reliable automatic assembly.

The ITF Coupler is offered in a variety of frequency bands compatible with various types of high frequency wireless systems.

FEATURES

- Small Size: 0805
- Frequency Range: 800MHz - 3GHz
- Characteristic Impedance: 50Ω
- Operating / Storage Temp.: -40°C to +85°C
- Power Rating: 3W Continuous
- Low Profile
- Rugged Construction
- Taped and Reeled

APPLICATIONS

- Mobile Communications
- Satellite TV Receivers
- GPS
- Vehicle Location Systems
- Wireless LAN's

DIMENSIONS:

millimeters (inches)

(Top View)

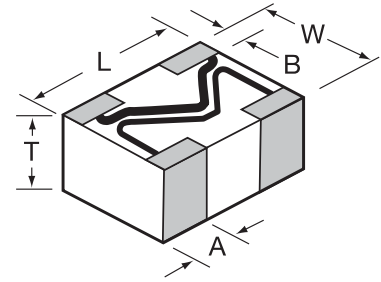

	0805
L	2.03±0.1 (0.080±0.004)
W	1.55±0.1 (0.061±0.004)
T	0.98±0.1 (0.039±0.004)
A	0.56±0.25 (0.022±0.010)
B	0.35±0.15 (0.014±0.006)

HOW TO ORDER

CP Style Directional Coupler	0805 Size 0805	A Layout Type (see layout types)	0902 Frequency MHz	A Sub-Type (see layout sub-types)	S Termination Code W = Nickel/Solder (Sn/Pb) **S = Nickel / Lead Free Solder (Sn100)	TR Packaging Code TR = Tape and Reel
---	---	---	---	--	--	---

Not RoHS Compliant



LEAD-FREE
LEAD-FREE COMPATIBLE
COMPONENT



For RoHS compliant products,
please select correct termination style.

****RoHS compliant**

QUALITY INSPECTION

Finished parts are 100% tested for electrical parameters and visual characteristics. Each production lot is evaluated on a sample basis for:

- Static Humidity: 85°C, 85% RH, 160 hours
- Endurance: 125°C, I_R, 4 hours

TERMINATION

Nickel/Solder coating (Sn, Pb) compatible with automatic soldering technologies: reflow, wave soldering, vapor phase and manual.

Recommended Pad Layout Dimensions mm (inches)

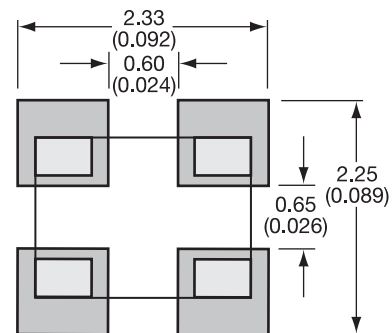

NOTE: Components must be mounted on the board with the white (Alumina) side DOWN.

Thin-Film RF/Microwave Directional Couplers

CP0302/CP0402/CP0603/CP0805 and DB0603N/DB0805 3dB 90°

CP0805 Layout Types

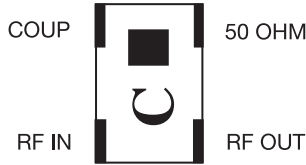

Type: A
Sub-Type: A

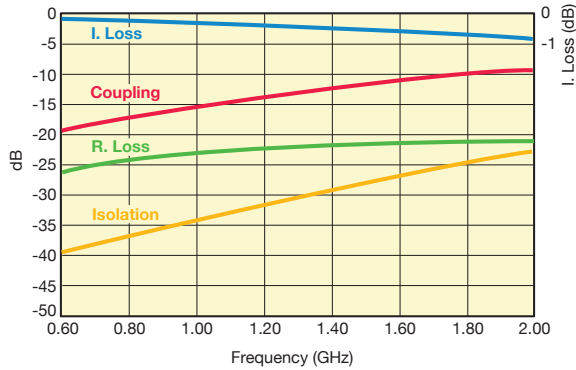

P/N Examples	Frequency Band [MHz]	Coupling [dB]	I. Loss max	VSWR max
CP0805A0836AS	824 - 849	16.5±1	0.25	1.2
CP0805A0881AS	869 - 894	16±1	0.25	1.2
CP0805A0902AS	890 - 915	16±1	0.25	1.2
CP0805A0947AS	935 - 960	15.5±1	0.25	1.2
CP0805A0897AS	880 - 915	16±1	0.25	1.2
CP0805A0942AS	925 - 960	15.5±1	0.25	1.2
CP0805A1441AS	1429 - 1453	12±1	0.5	1.3
CP0805A1747AS	1710 - 1785	10.5±1	0.7	1.4
CP0805A1842AS	1805 - 1880	10±1	0.8	1.4
CP0805A1880AS	1850 - 1910	9.5±1	0.8	1.4
CP0805A1960AS	1930 - 1990	9.5±1	0.8	1.4
CP0805A1907AS	1895 - 1920	9.5±1	0.8	1.4
CP0805A1890AS	1880 - 1900	9.5±1	0.8	1.4



Type: A
Sub-Type: B

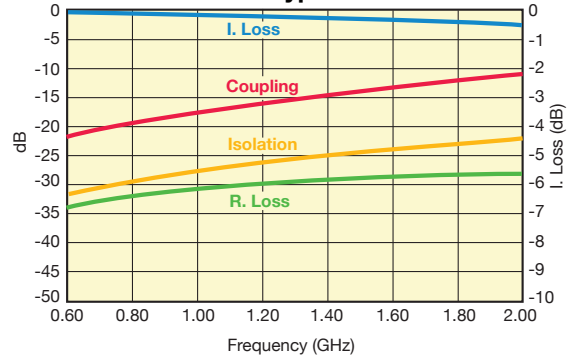

P/N Examples	Frequency Band [MHz]	Coupling [dB]	I. Loss max	VSWR max
CP0805A0836BS	824 - 849	19±1	0.25	1.2
CP0805A0881BS	869 - 894	18.5±1	0.25	1.2
CP0805A0902BS	890 - 915	18±1	0.25	1.2
CP0805A0947BS	935 - 960	18±1	0.25	1.2
CP0805A0897BS	880 - 915	18.5±1	0.25	1.2
CP0805A0942BS	925 - 960	18±1	0.25	1.2
CP0805A1441BS	1429 - 1453	14.5±1	0.35	1.2
CP0805A1747BS	1710 - 1785	12.5±1	0.5	1.4
CP0805A1842BS	1805 - 1880	12.5±1	0.5	1.4
CP0805A1880BS	1850 - 1910	12±1	0.6	1.4
CP0805A1960BS	1930 - 1990	11.5±1	0.7	1.4
CP0805A1907BS	1895 - 1920	12±1	0.6	1.4
CP0805A1890BS	1880 - 1900	12±1	0.6	1.4
CP0805A2442BS	2400 - 2484	10±1	0.9	1.4

Type: A
Sub-Type: C

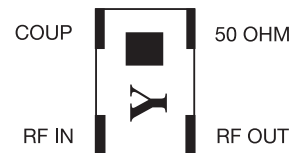
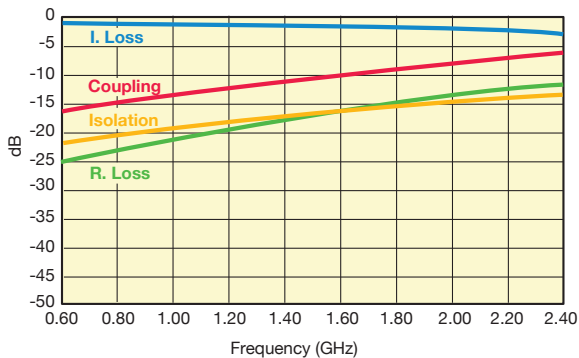

P/N Examples	Frequency Band [MHz]	Coupling [dB]	I. Loss max	VSWR max
CP0805A0836CS	824 - 849	14±1	0.5	1.4
CP0805A0881CS	869 - 894	13.5±1	0.5	1.4
CP0805A0902CS	890 - 915	13.5±1	0.5	1.4
CP0805A0947CS	935 - 960	13±1	0.5	1.4
CP0805A0897CS	880 - 915	13.5±1	0.5	1.4
CP0805A0942CS	925 - 960	13±1	0.5	1.4
CP0805A1441CS	1429 - 1453	9.5±1	1.15	1.8
CP0805A1747CS	1710 - 1785	8±1	1.6	2.2
CP0805A1842CS	1805 - 1880	8±1	1.6	2.2
CP0805A1880CS	1850 - 1910	7.5±1	1.75	2.2
CP0805A1960CS	1930 - 1990	7.5±1	1.75	2.2
CP0805A1907CS	1895 - 1920	7.5±1	1.75	2.2
CP0805A1890CS	1880 - 1900	7.5±1	1.75	2.2
CP0805A2442CS	2400 - 2484	6±1	2.5	2.2

Important: Couplers can be used at any frequency within the indicated range.

Thin-Film RF/Microwave Directional Couplers

CP0302/CP0402/CP0603/CP0805 and DB0603N/DB0805 3dB 90°

CP0805 Layout Types

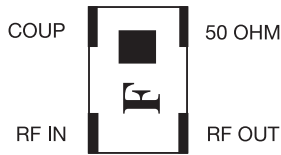

Type: A
Sub-Type: D

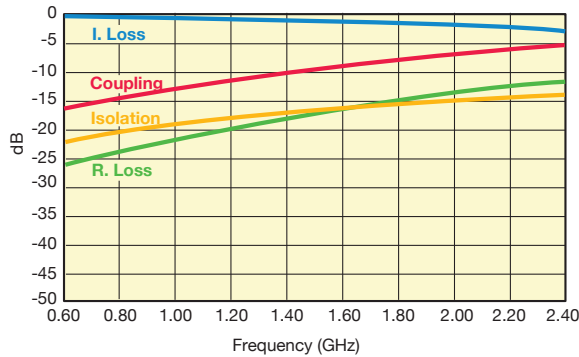

P/N Examples	Frequency Band [MHz]	Coupling [dB]	I. Loss max	VSWR max
CP0805A0836DS	824 - 849	13.0±1	0.5	1.4
CP0805A0881DS	869 - 894	12.5±1	0.5	1.4
CP0805A0902DS	890 - 915	12.5±1	0.5	1.4
CP0805A0947DS	935 - 960	12±1	0.5	1.4
CP0805A0897DS	880 - 915	12.5±1	0.5	1.4
CP0805A0942DS	925 - 960	12±1	0.5	1.4
CP0805A1441DS	1429 - 1453	8.5±1	1.25	1.8
CP0805A1747DS	1710 - 1785	7±1	1.85	1.8
CP0805A1842DS	1805 - 1880	7±1	1.85	1.8
CP0805A1880DS	1850 - 1910	7±1	1.85	1.8
Cp0805A1960DS	1930 - 1990	6.5±1	2.15	2.1
CP0805A1907DS	1895 - 1920	6.5±1	2.15	2.1
CP0805A1890DS	1880 - 1900	7±1	1.85	1.8
CP0805A2442DS	2400 - 2484	5.5±1	2.4	2.1

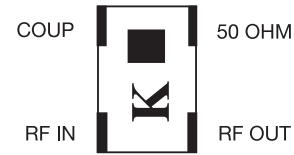

Type: A
Sub-Type: E

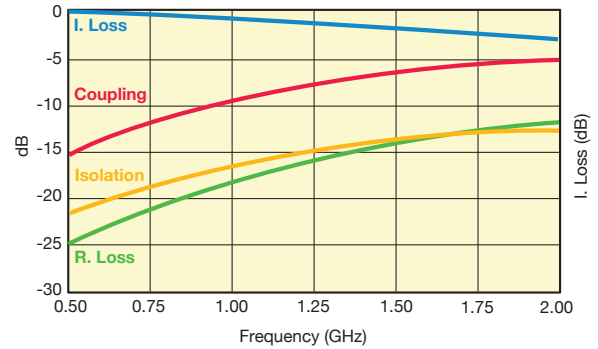

P/N Examples	Frequency Band [MHz]	Coupling [dB]	I. Loss max	VSWR max
CP0805A0836ES	824 - 849	11±1	0.85	1.4
CP0805A0881ES	869 - 894	10.5±1	0.85	1.4
CP0805A0902ES	890 - 915	10.5±1	0.85	1.4
CP0805A0947ES	935 - 960	10±1	0.85	1.4
CP0805A0897ES	880 - 915	10.5±1	0.85	1.4
CP0805A0942ES	925 - 960	10±1	0.85	1.4
CP0805A1441ES	1429 - 1453	7±1	1.8	1.8
CP0805A1747ES	1710 - 1785	5.5±1	2.7	2.2
CP0805A1842ES	1805 - 1880	5.5±1	2.7	2.2
CP0805A1880ES	1850 - 1910	5±1	3.15	2.4
Cp0805A1960ES	1930 - 1990	5±1	3.15	2.4
CP0805A1907ES	1895 - 1920	5±1	3.15	2.4
CP0805A1890ES	1880 - 1900	5±1	3.15	2.4
CP0805A2442ES	2400 - 2484	4±1	4.2	2.4

Important: Couplers can be used at any frequency within the indicated range.

Thin-Film RF/Microwave Directional Couplers

CP0302/CP0402/CP0603/CP0805 and DB0603N/DB0805 3dB 90°

CP0805 Layout Types

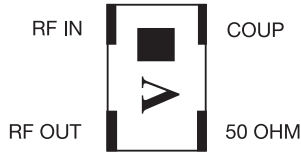

Type: B
Sub-Type: B

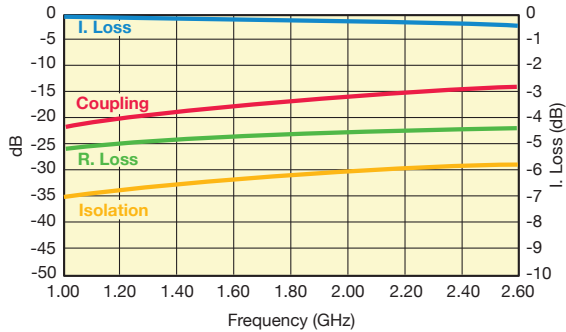

P/N Examples	Frequency Band [MHz]	Coupling [dB]	I. Loss max	VSWR max
CP0805B0836BS	824 - 849	23.5±1	0.25	1.2
CP0805B0881BS	869 - 894	23±1	0.25	1.2
CP0805B0902BS	890 - 915	22.5±1	0.25	1.2
CP0805B0947BS	935 - 960	22±1	0.25	1.2
CP0805B0897BS	880 - 915	23±1	0.25	1.2
CP0805B0942BS	925 - 960	22±1	0.25	1.2
CP0805B1441BS	1429 - 1453	18.5±1	0.25	1.2
CP0805B1747BS	1710 - 1785	17±1	0.25	1.2
CP0805B1842BS	1805 - 1880	16.5±1	0.25	1.2
CP0805B1880BS	1850 - 1910	16.5±1	0.25	1.2
CP0805B1960BS	1930 - 1990	16±1	0.25	1.2
CP0805B1907BS	1895 - 1920	16±1	0.25	1.2
CP0805B1890BS	1880 - 1900	16±1	0.25	1.2
CP0805B2442BS	2400 - 2484	14±1	0.4	1.2



Type: B
Sub-Type: C

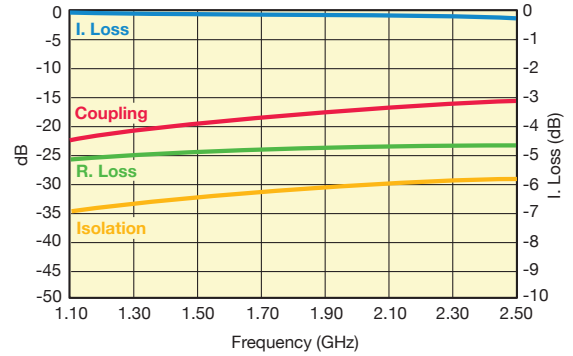

P/N Examples	Frequency Band [MHz]	Coupling [dB]	I. Loss max	VSWR max
CP0805B0836CS	824 - 849	25±1	0.25	1.2
CP0805B0881CS	869 - 894	24.5±1	0.25	1.2
CP0805B0902CS	890 - 915	24±1	0.25	1.2
CP0805B0947CS	935 - 960	24±1	0.25	1.2
CP0805B0897CS	880 - 915	24.5±1	0.25	1.2
CP0805B0942CS	925 - 960	24±1	0.25	1.2
CP0805B1441CS	1429 - 1453	20±1	0.25	1.2
CP0805B1747CS	1710 - 1785	18.5±1	0.25	1.2
CP0805B1842CS	1805 - 1880	18.5±1	0.25	1.2
CP0805B1880CS	1850 - 1910	18±1	0.25	1.2
CP0805B1960CS	1930 - 1990	17.5±1	0.25	1.2
CP0805B1907CS	1895 - 1920	18±1	0.25	1.2
CP0805B1890CS	1880 - 1900	18±1	0.25	1.2
CP0805B2442CS	2400 - 2484	16±1	0.4	1.2

Type: B
Sub-Type: B

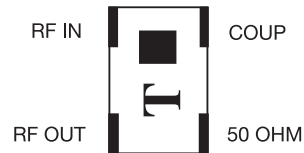
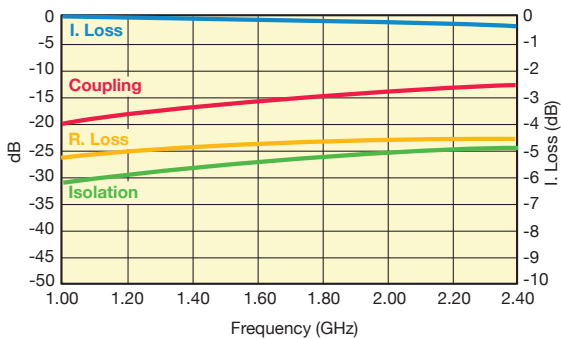

P/N Examples	Frequency Band [MHz]	Coupling [dB]	I. Loss max	VSWR max
CP0805B0836AS	824 - 849	21.5±1	0.25	1.2
CP0805B0881AS	869 - 894	21±1	0.25	1.2
CP0805B0902AS	890 - 915	21±1	0.25	1.2
CP0805B0947AS	935 - 960	20.5±1	0.25	1.2
CP0805B0897AS	880 - 915	21±1	0.25	1.2
CP0805B0942AS	925 - 960	20.5±1	0.25	1.2
CP0805B1441AS	1429 - 1453	17±1	0.25	1.2
CP0805B1747AS	1710 - 1785	15.5±1	0.25	1.2
CP0805B1842AS	1805 - 1880	15.5±1	0.3	1.2
CP0805B1880AS	1850 - 1910	15±1	0.3	1.2
CP0805B1960AS	1930 - 1990	14.5±1	0.4	1.2
CP0805B1907AS	1895 - 1920	15±1	0.3	1.2
CP0805B1890AS	1880 - 1900	15±1	0.3	1.2
CP0805B2442AS	2400 - 2484	13±1	0.4	1.2

Important: Couplers can be used at any frequency within the indicated range.

Thin-Film RF/Microwave Directional Couplers

CP0302/CP0402/CP0603/CP0805 and DB0603N/DB0805 3dB 90°

CP0805 Layout Types



VHF DIRECTIONAL COUPLER CP0805L0155ASTR



P/N	Frequency [MHz]	Coupling [dB]	R. Loss [dB]	I. Loss max [dB]	Directivity [dB]
CP0805L0155ASTR	155	17.1±1	24	0.35	22

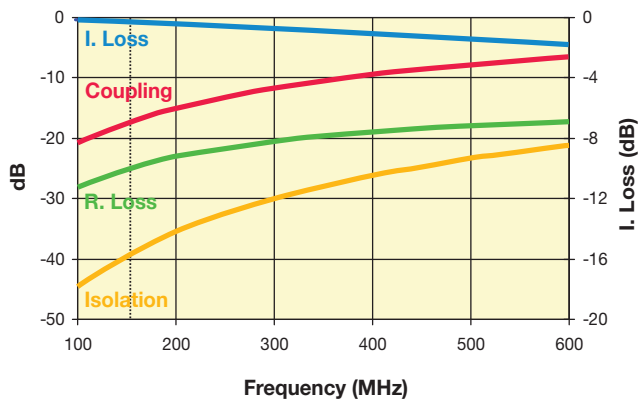

UHF DIRECTIONAL COUPLER CP0805L0436BSTR



P/N	Frequency [MHz]	Coupling [dB]	R. Loss [dB]	I. Loss max [dB]	Directivity [dB]
CP0805L0436BSTR	403-470	15.85±1	35	0.25	22

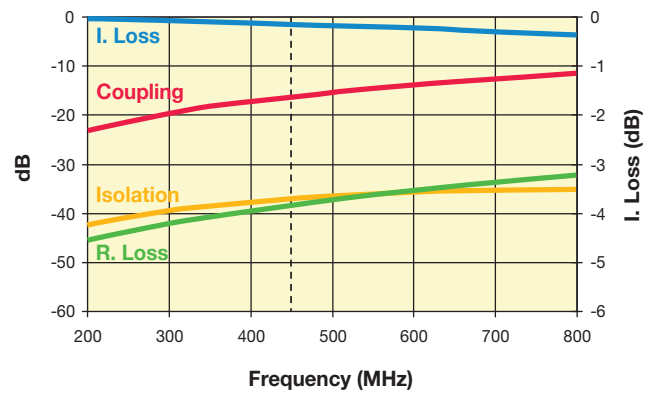

Important: Couplers can be used at any frequency within the indicated range.

Thin-Film RF/Microwave Directional Couplers

CP0302/CP0402/CP0603/CP0805 and DB0603N/DB0805 3dB 90°

CP0805 and CP0603 Test Jig



ITF TEST JIG FOR COUPLER TYPES 0805 AND 0603 SMD

GENERAL DESCRIPTION

This jig is designed for the testing of CP0805 and CP0603 series Directional Couplers using a vector network analyzer.

It consists of a FR4 multi-layer substrate, having 50Ω microstrips as conducting lines and a ground plane in the middle layer, located at a distance of 0.2mm from the microstrips.

The connectors are SMA type (female), 'Johnson Components Inc.' Product P/N: 142-0701-881.

The jig is designed for a full 2-port calibration. LOAD calibration can be done either by a 50Ω SMA termination, or by soldering a 50Ω chip resistor at the 50Ω ports.

MEASUREMENT PROCEDURE

When measuring a component, it can be either soldered or pressed by a non-metallic stick until all four ports touch the appropriate pads. To measure the coupling (and the R. Loss) place the component on the Port 1 & Port 2 pads. Use two SMA 50Ω terminations (male) to terminate the ports, which are not connected to the network analyzer, and connect the network analyzer to the two ports. A 90° rotation of the component on its pads allows measuring a second parameter (I. Loss).

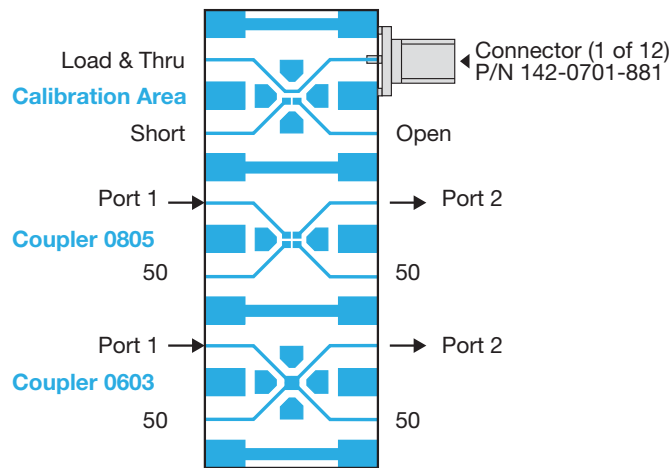

CP0805 SERIES DIRECTIONAL COUPLERS

Orientation and Tape and Reel Packaging Specification (Top View)

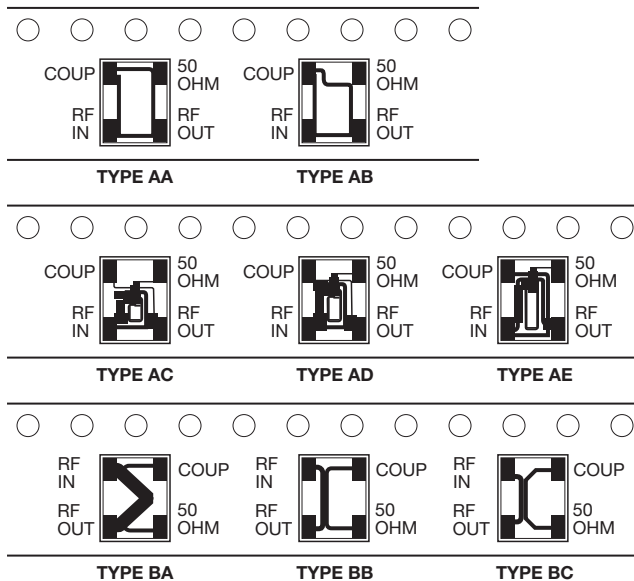

The parts should be mounted on the PCB with White (Alumina) side down and the "dark" side up.

CP0805xxxxxxSTR (Sn100)

(Top View)

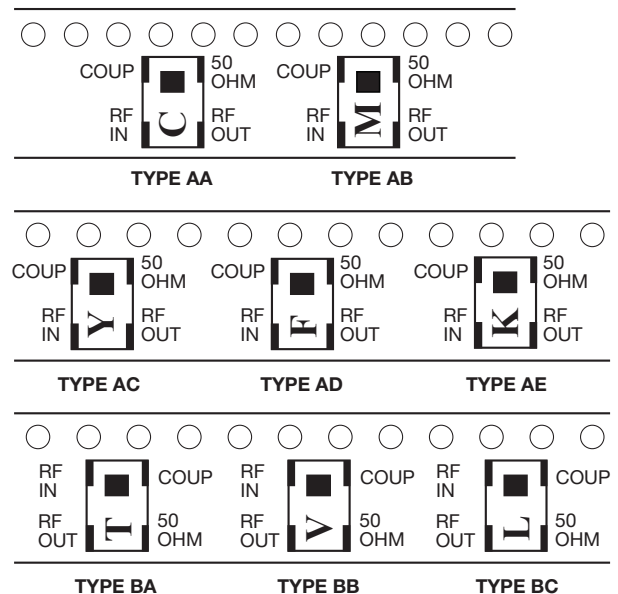

The parts should be mounted on the PCB with printed side up.

Thin-Film RF/Microwave Directional Couplers

CP0302/CP0402/CP0603/CP0805 and DB0603N/DB0805 3dB 90° DB0603N 3dB 90° Couplers



GENERAL DESCRIPTION RFAP TECHNOLOGY

The DB0603N 3dB 90° Coupler is based on thin-film multilayer technology. The technology provides a miniature part with excellent high frequency performance and rugged construction for reliable automatic assembly.

The RFAP LGA 3dB 90° Coupler will be offered in a variety of frequency bands compatible with various types of high frequency wireless systems.

APPLICATIONS

- 4G LTE
- 5G LTE
- Base Stations.
- Automotive
- Industrial
- Balanced Amplifiers and Signal Distribution in Wireless Communications



FEATURES

- Miniature 0603 size
- Low I. Loss
- High Isolation
- Surface Mountable
- RoHS Compliant
- Supplied on T&R
- Power Rating:
10W RF
Continuous

LAND GRID ARRAY ADVANTAGES:

- Inherent Low Profile
- Self Alignment during Reflow
- Excellent Solderability
- Low Parasitics
- Better Heat Dissipation

RECOMMENDED PAD LAYOUT DIMENSIONS:

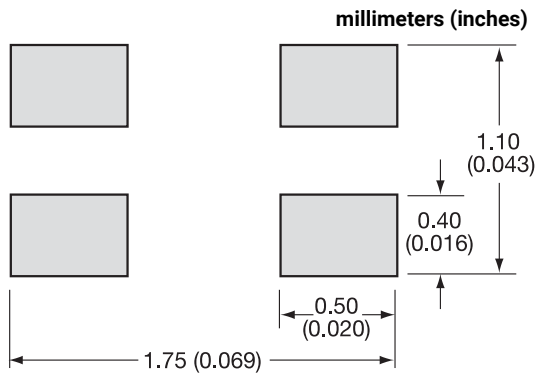

DIMENSIONS:

	millimeters (inches)
L	1.60±0.10 (0.063±0.004)
W	0.84±0.10 (0.033±0.004)
T	0.60±0.10 (0.024±0.004)
A	0.25±0.05 (0.010±0.002)
B	0.20±0.05 (0.008±0.002)
S	0.05±0.05 (0.002±0.002)

BOTTOM VIEW

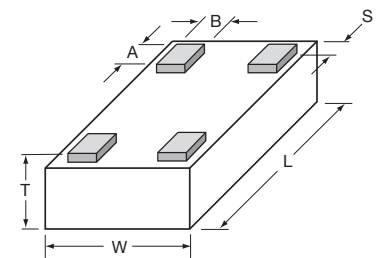

ORIENTATION IN TAPE

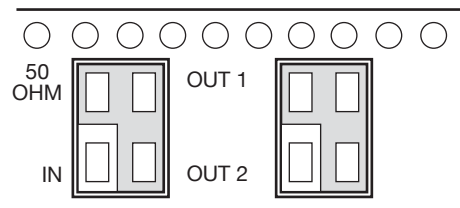

ELECTRICAL PARAMETERS

Part Number	Frequency MHz		Port Impedance Ω	Return Loss [dB]		Isolation [dB]		Insertion Loss [dB]		Amplitude Balance [dB]		Phase Balance (Relative to 90°) Deg		Power Handling Watts
	Min.	Max.	Typ.	Min.	Typ.	Min.	Typ.	Typ.	Max.	Typ.	Max.	Typ.	Max.	Max.
DB0603N2140ANTR	2040	2240	50	15	26	15	23	0.30	0.40	0.50	0.80	2	3	10
DB0603N2400ANTR	2300	2500	50	12	17	15	23	0.25	0.35	0.30	0.80	2	3	10
DB0603N2600ANTR	2400	2800	50	12	17	15	23	0.25	0.35	0.30	0.80	2	3	10
DB0603N3000ANTR	2850	3150	50	12	15	15	26	0.20	0.30	0.30	0.80	2	3	10
DB0603N3500ANTR	3300	3700	50	12	15	15	26	0.20	0.30	0.30	0.80	2	3	10
DB0603N4600ANTR	4200	5000	50	12	16	12	15	0.50	0.70	0.40	1.00	1.5	3	10
DB0603N5500ANTR	5100	5900	50	12	16	10	14	0.60	0.80	0.80	1.50	1	3	10
DB0603N5800ANTR	5600	6000	50	12	16	12	17	0.40	0.90	0.30	0.90	2	3	10

NOTE: Additional Frequencies Available Upon Request

Thin-Film RF/Microwave Directional Couplers

CP0302/CP0402/CP0603/CP0805 and DB0603N/DB0805 3dB 90°

DB0603N 3dB 90° Couplers



2040MHZ TO 2240MHZ DB0603N2140ANTR

Return Loss - Input

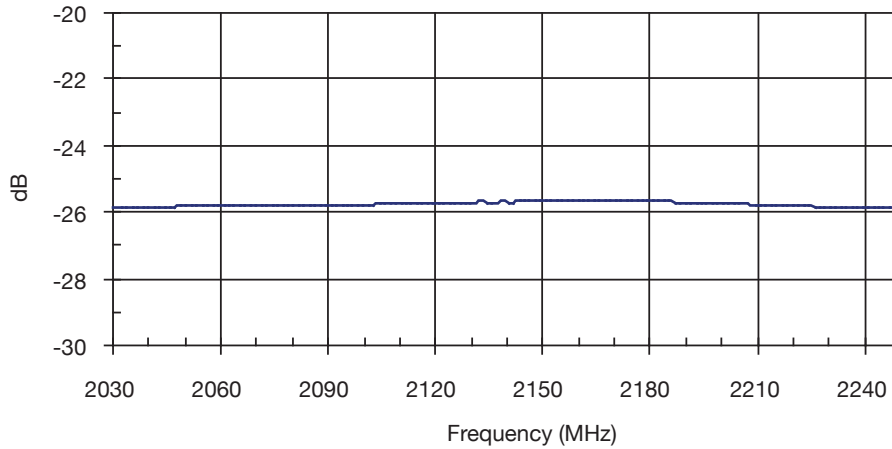

Insertion Loss

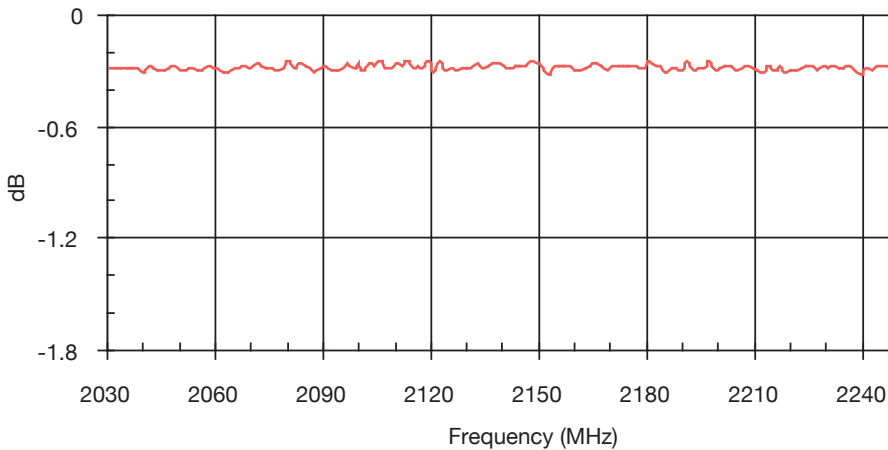

Amplitude Balance

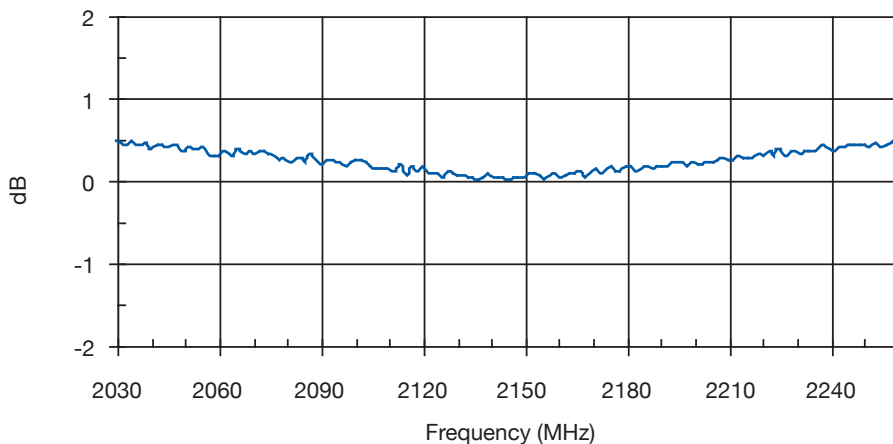

Thin-Film RF/Microwave Directional Couplers

CP0302/CP0402/CP0603/CP0805 and DB0603N/DB0805 3dB 90° DB0603N 3dB 90° Couplers



2040MHZ TO 2240MHZ DB0603N2140ANTR

Phase Balance

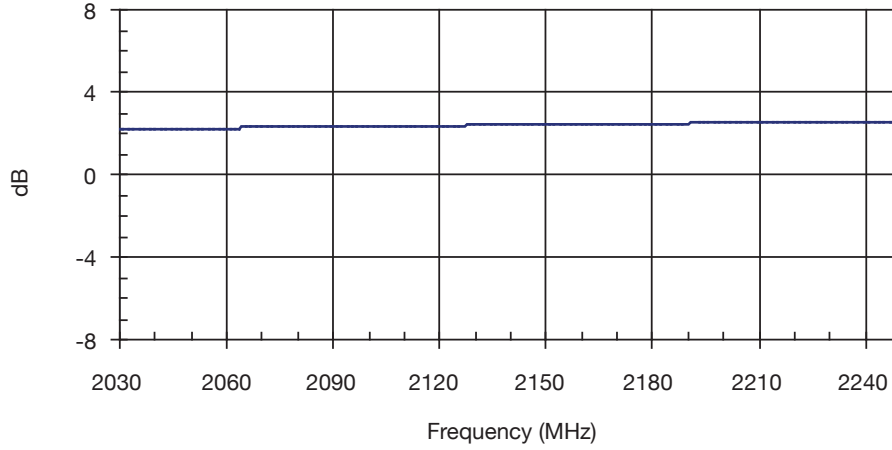

Isolation

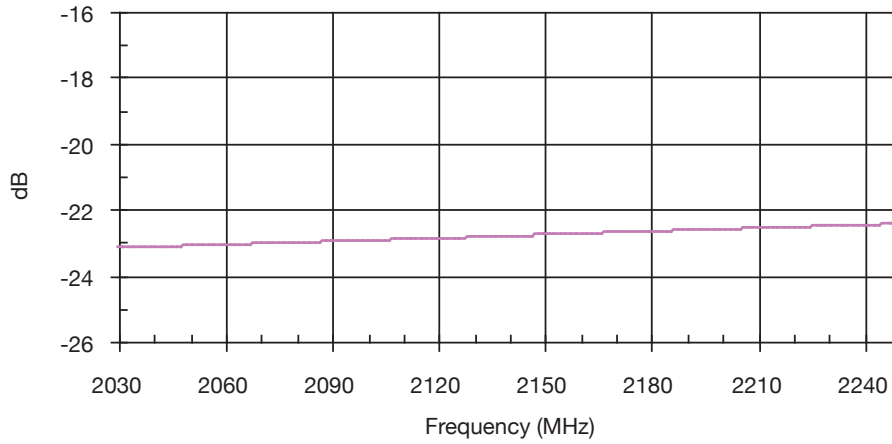

Thin-Film RF/Microwave Directional Couplers

CP0302/CP0402/CP0603/CP0805 and DB0603N/DB0805 3dB 90° DB0603N 3dB 90° Couplers



2200MHZ TO 2600MHZ DB0603N2400ANTR

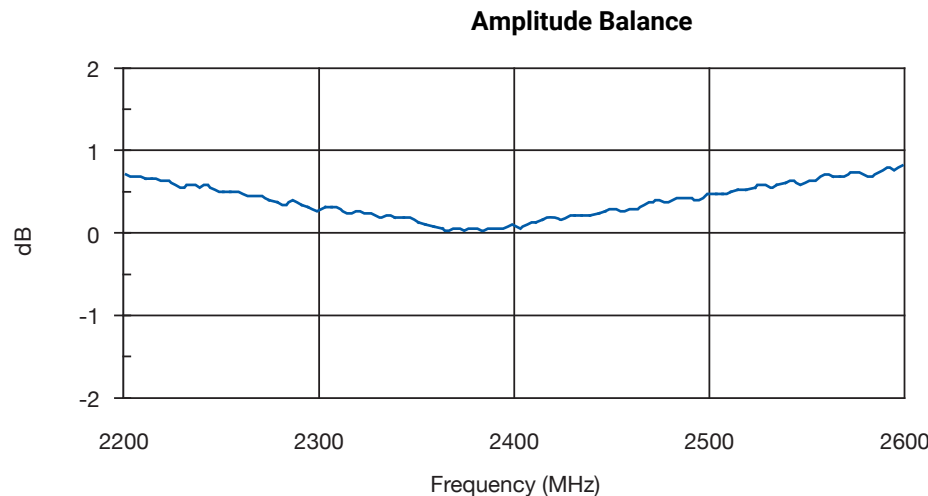
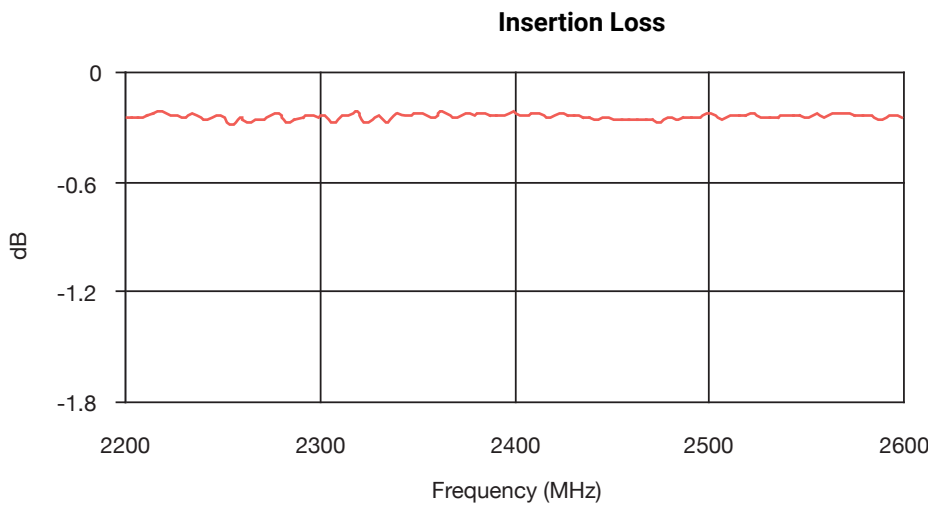
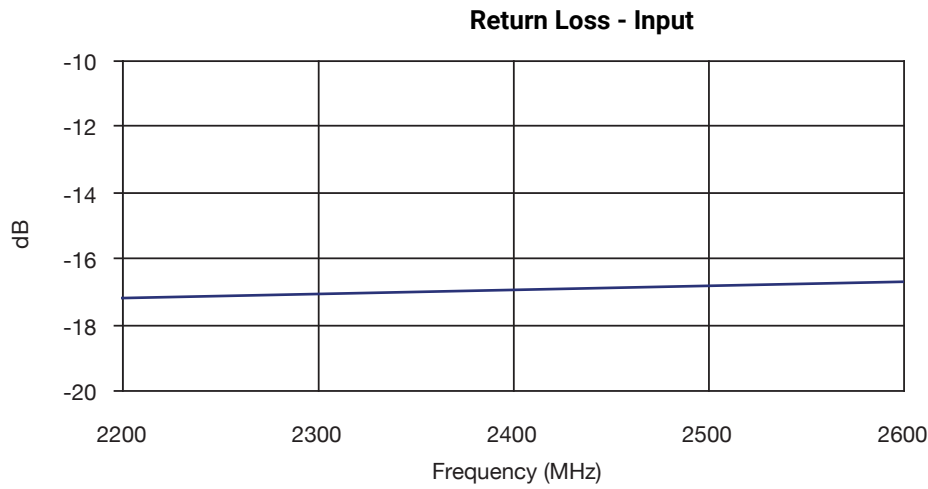

Thin-Film RF/Microwave Directional Couplers

CP0302/CP0402/CP0603/CP0805 and DB0603N/DB0805 3dB 90° DB0603N 3dB 90° Couplers



2200MHZ TO 2600MHZ DB0603N2400ANTR

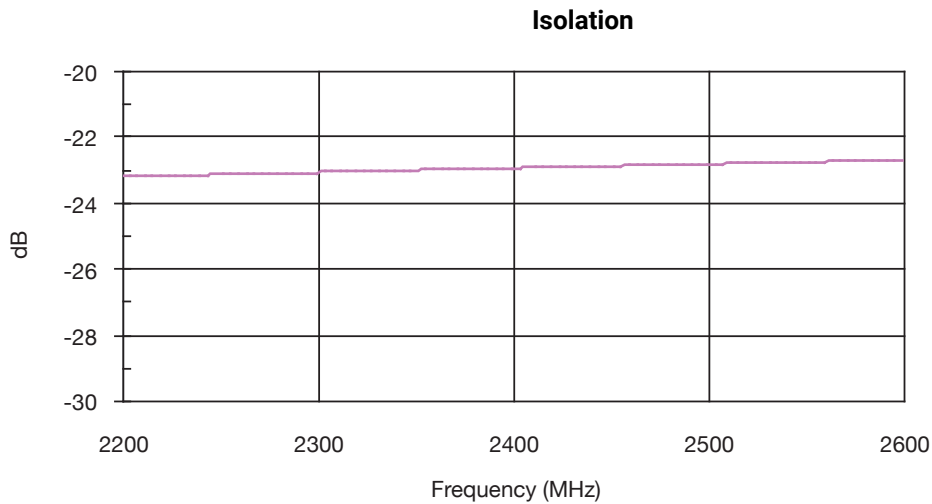
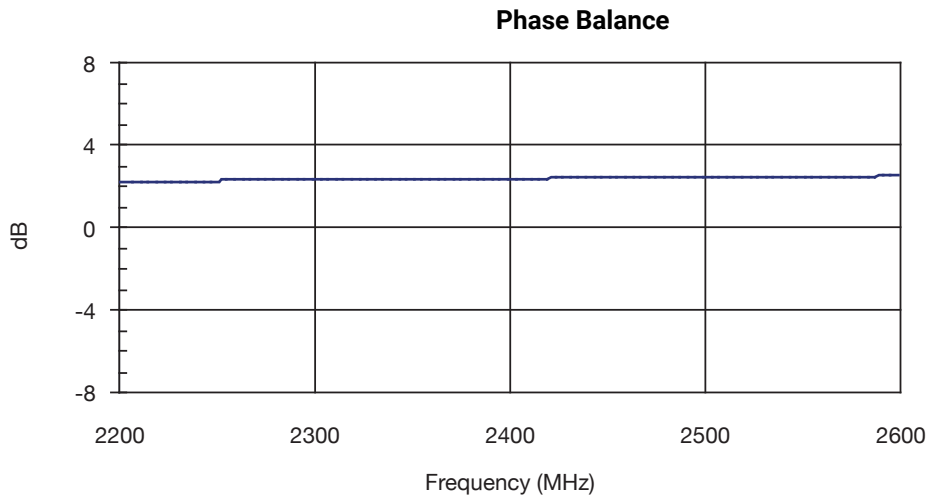

Thin-Film RF/Microwave Directional Couplers

CP0302/CP0402/CP0603/CP0805 and DB0603N/DB0805 3dB 90° DB0603N 3dB 90° Couplers



2400MHZ TO 2800MHZ DB0603N2600ANTR

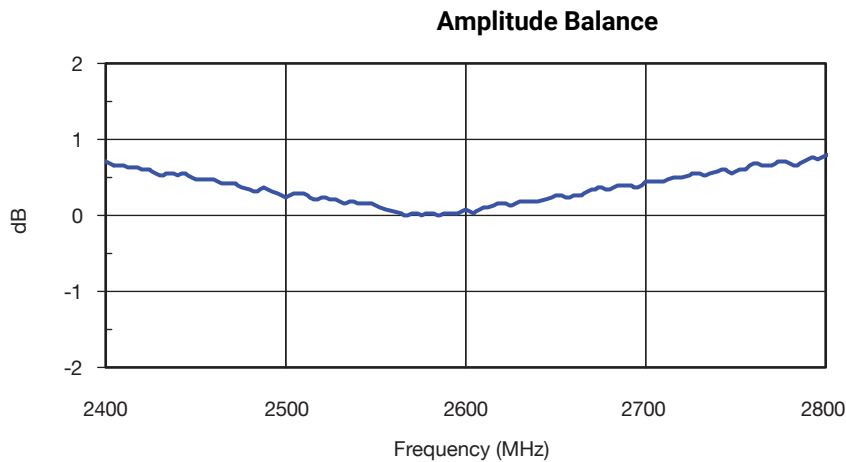
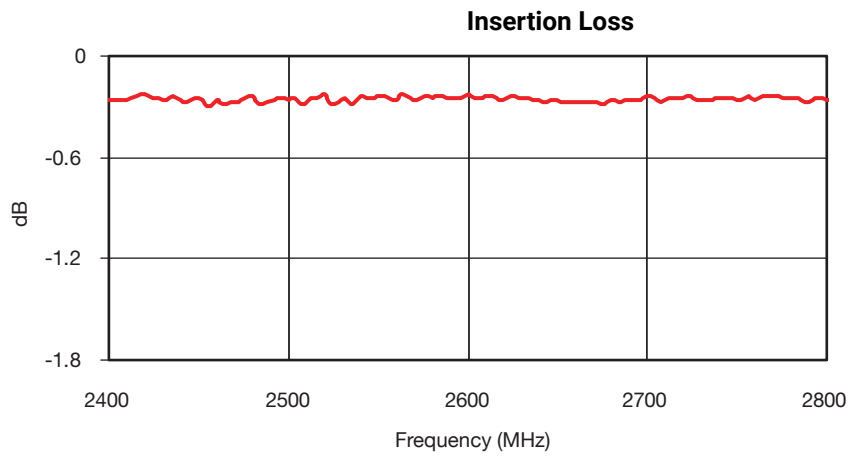
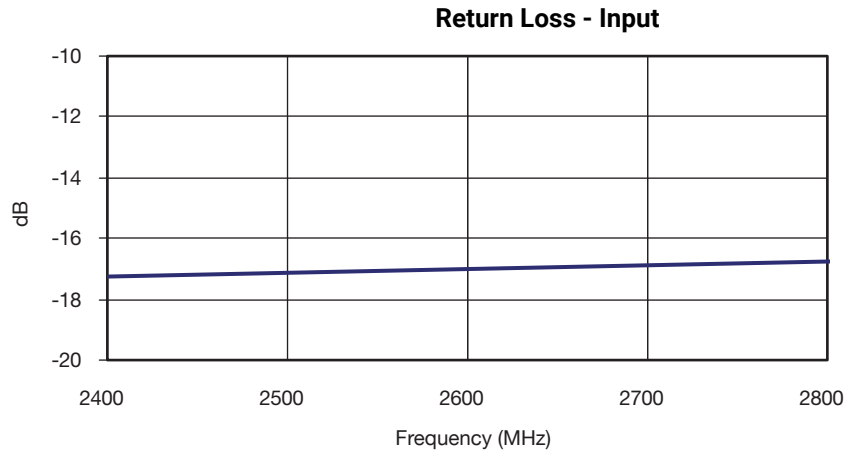

Thin-Film RF/Microwave Directional Couplers

CP0302/CP0402/CP0603/CP0805 and DB0603N/DB0805 3dB 90° DB0603N 3dB 90° Couplers



2400MHZ TO 2800MHZ DB0603N2600ANTR

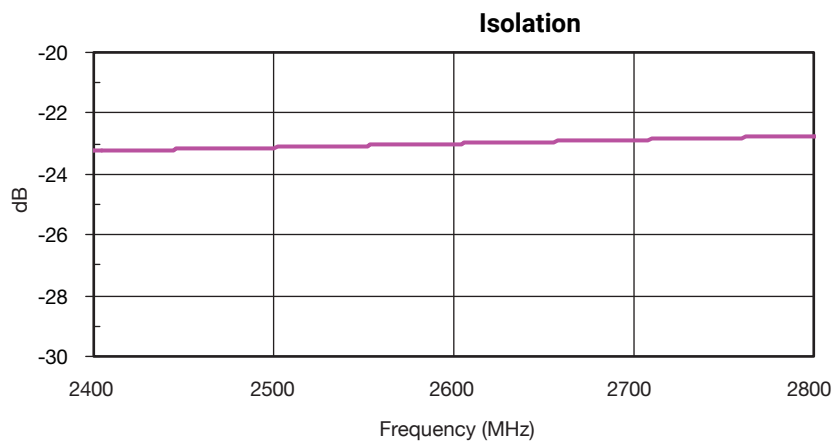
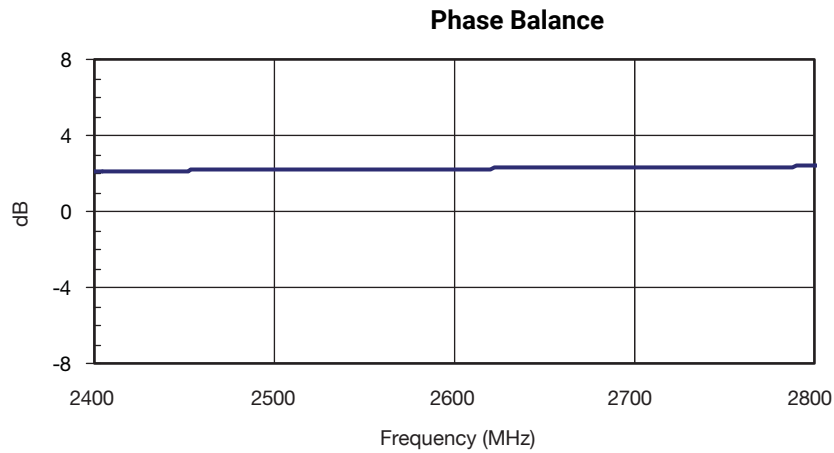

Thin-Film RF/Microwave Directional Couplers

CP0302/CP0402/CP0603/CP0805 and DB0603N/DB0805 3dB 90° DB0603N 3dB 90° Couplers



2850MHZ TO 3150MHZ DB0603N3000ANTR

Return Loss - Input

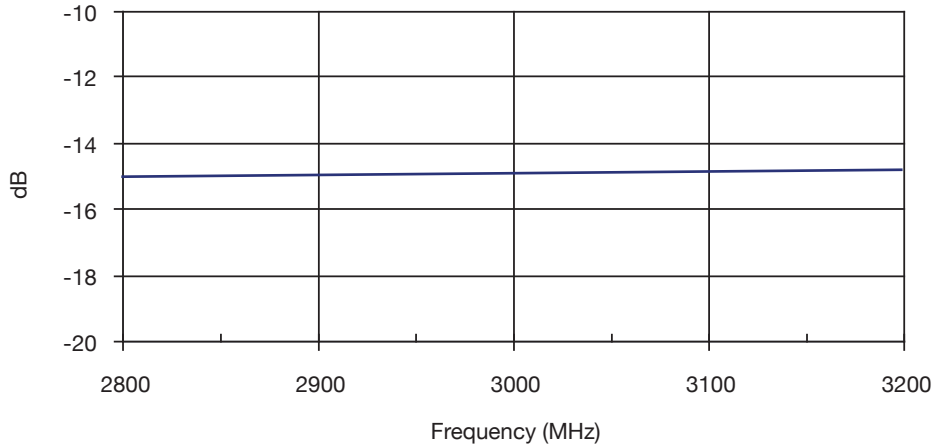

Insertion Loss

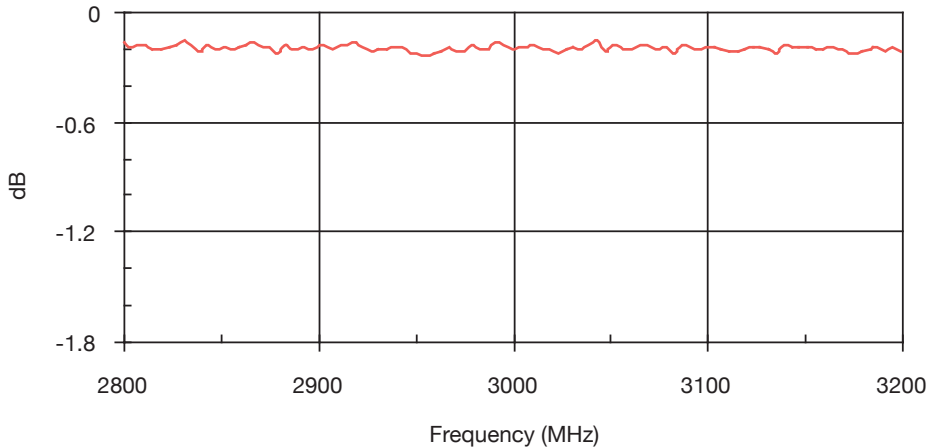

Amplitude Balance

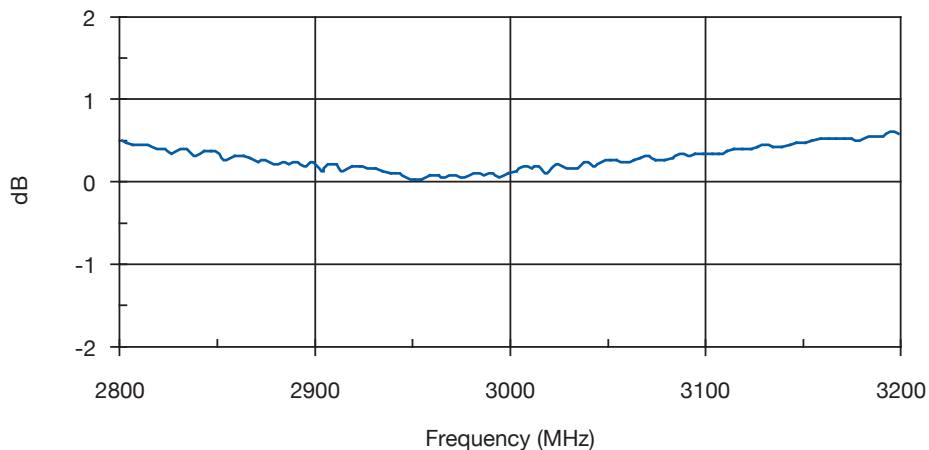

Thin-Film RF/Microwave Directional Couplers

CP0302/CP0402/CP0603/CP0805 and DB0603N/DB0805 3dB 90° DB0603N 3dB 90° Couplers



2850MHZ TO 3150MHZ DB0603N3000ANTR

Phase Balance

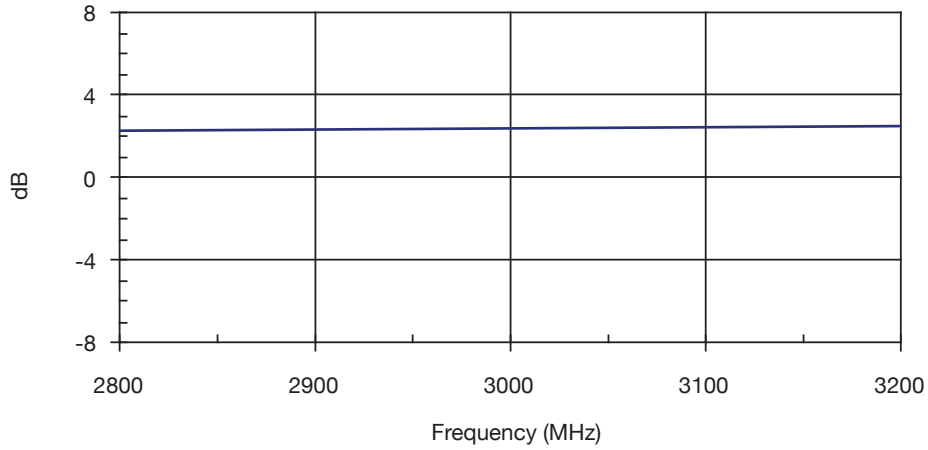

Isolation

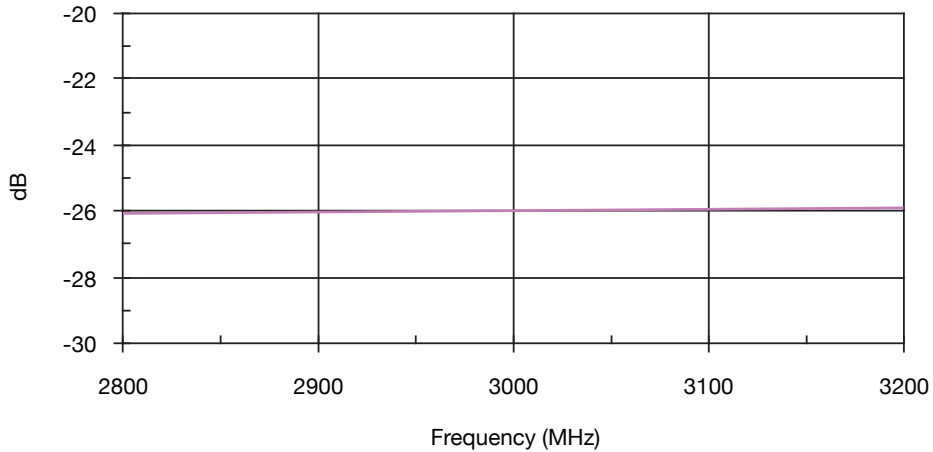

Thin-Film RF/Microwave Directional Couplers

CP0302/CP0402/CP0603/CP0805 and DB0603N/DB0805 3dB 90° DB0603N 3dB 90° Couplers



3200MHZ TO 3800MHZ DB0603N3500ANTR

Return Loss - Input

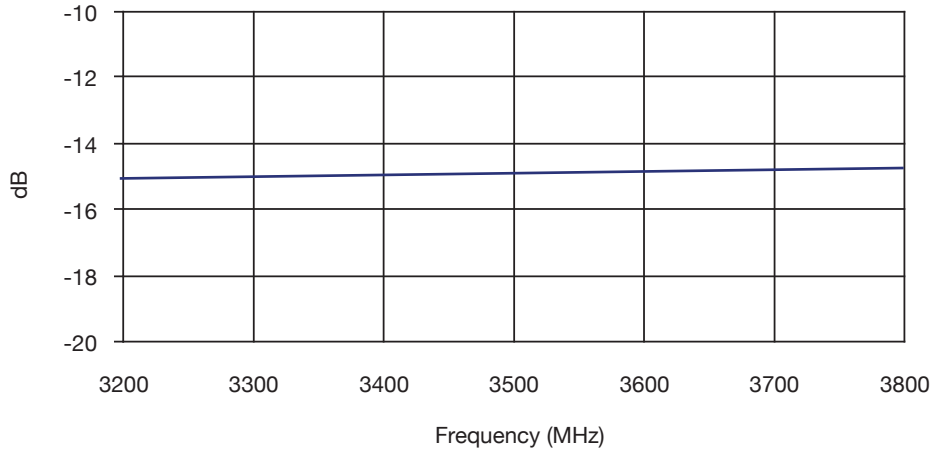

Insertion Loss

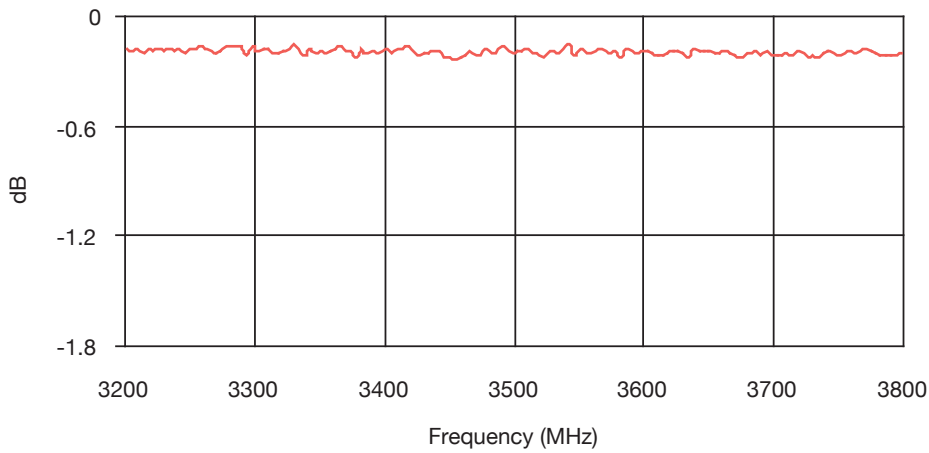

Amplitude Balance

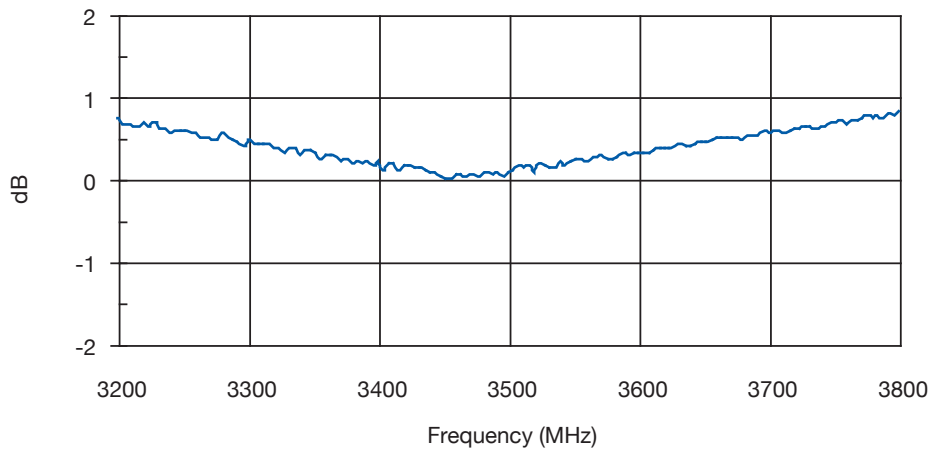

Thin-Film RF/Microwave Directional Couplers

CP0302/CP0402/CP0603/CP0805 and DB0603N/DB0805 3dB 90° DB0603N 3dB 90° Couplers



3200MHZ TO 3800MHZ DB0603N3500ANTR

Phase Balance

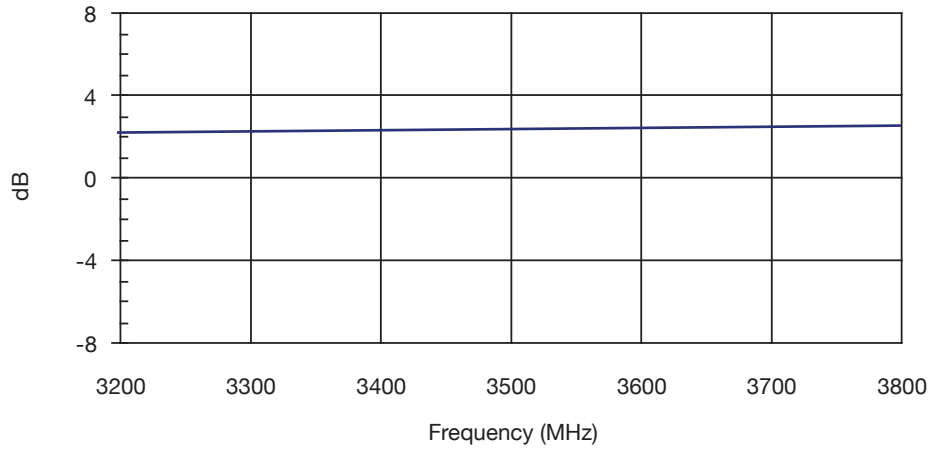

Isolation

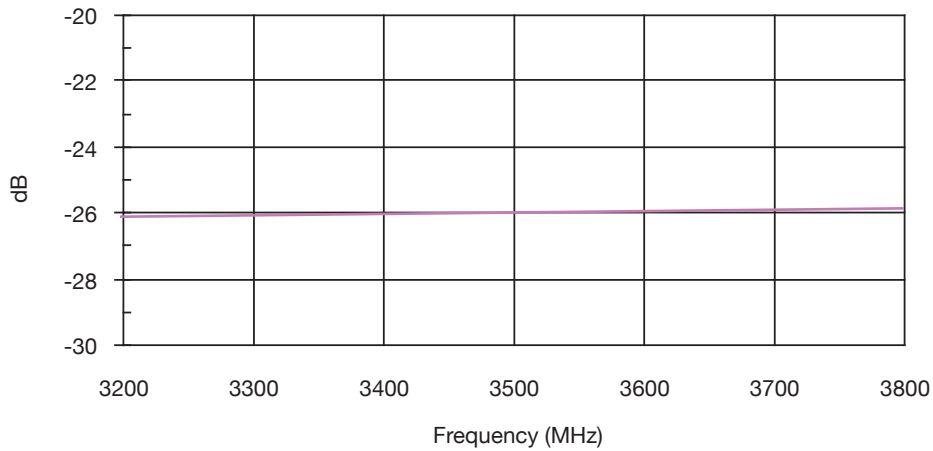

Thin-Film RF/Microwave Directional Couplers

CP0302/CP0402/CP0603/CP0805 and DB0603N/DB0805 3dB 90° DB0603N 3dB 90° Couplers



4200MHZ TO 5000MHZ DB0603N4600ANTR

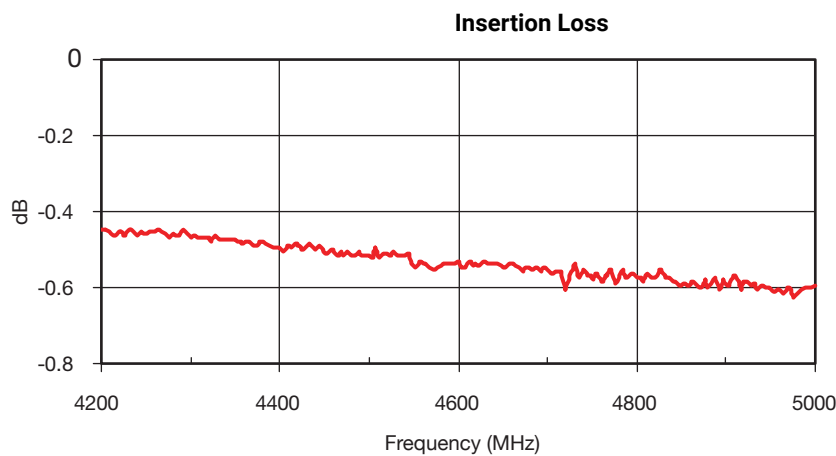
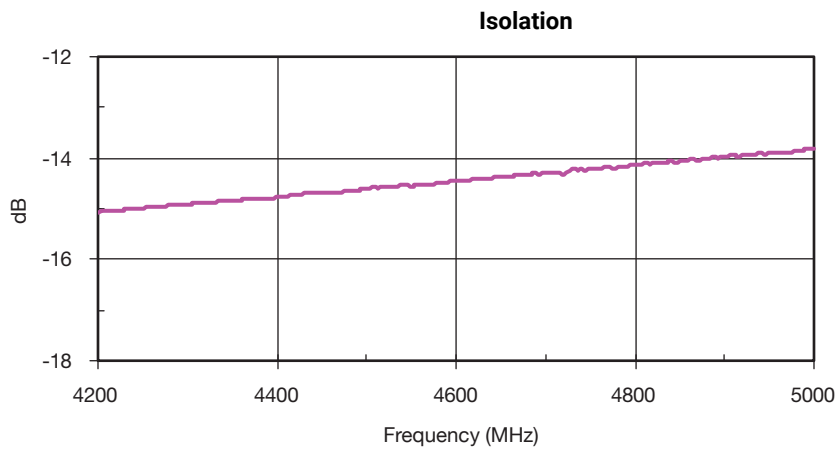
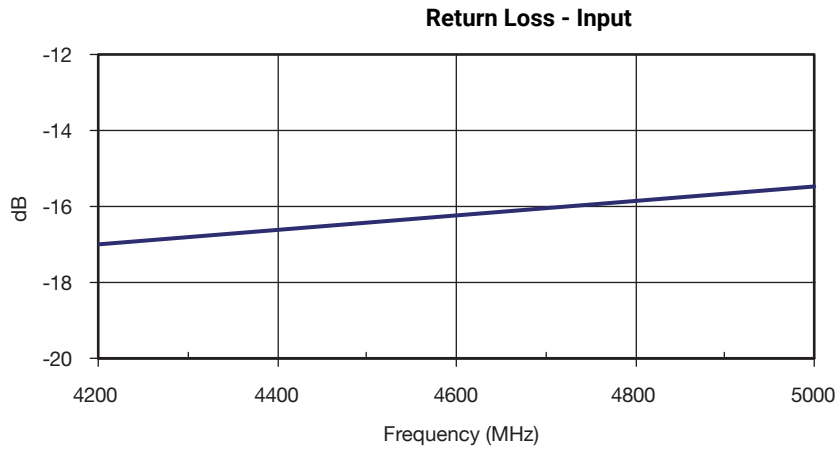

Thin-Film RF/Microwave Directional Couplers

CP0302/CP0402/CP0603/CP0805 and DB0603N/DB0805 3dB 90° DB0603N 3dB 90° Couplers



4200MHZ TO 5000MHZ DB0603N4600ANTR

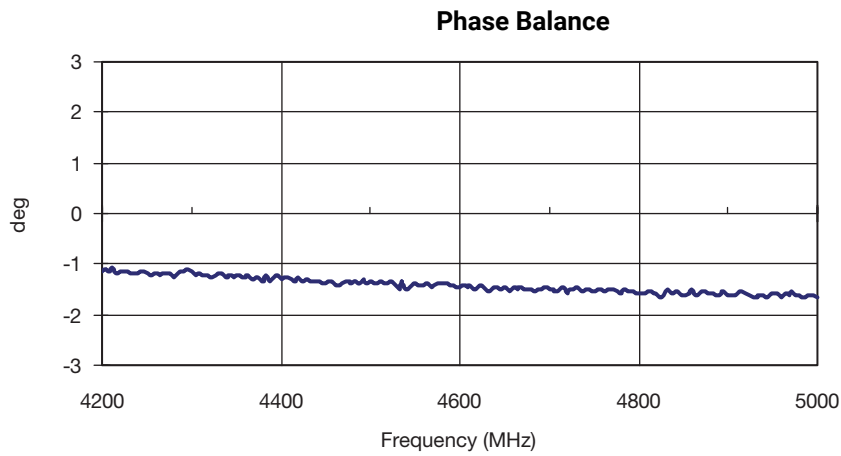
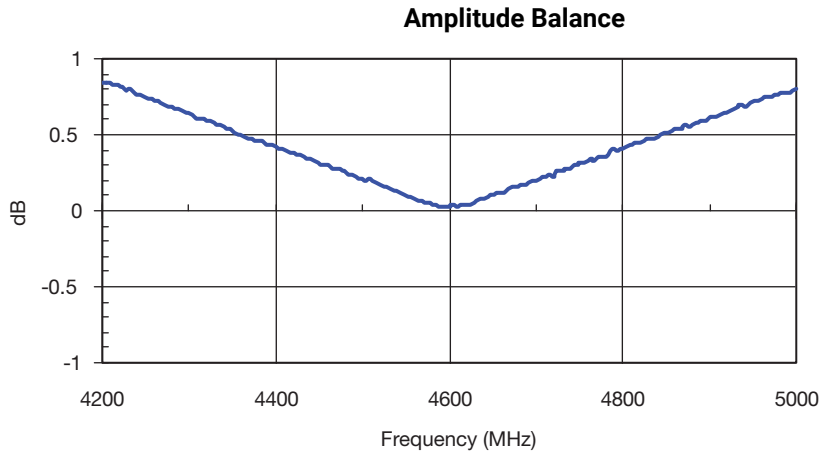

Thin-Film RF/Microwave Directional Couplers

CP0302/CP0402/CP0603/CP0805 and DB0603N/DB0805 3dB 90° DB0603N 3dB 90° Couplers



5100MHZ TO 5900MHZ DB0603N5500ANTR

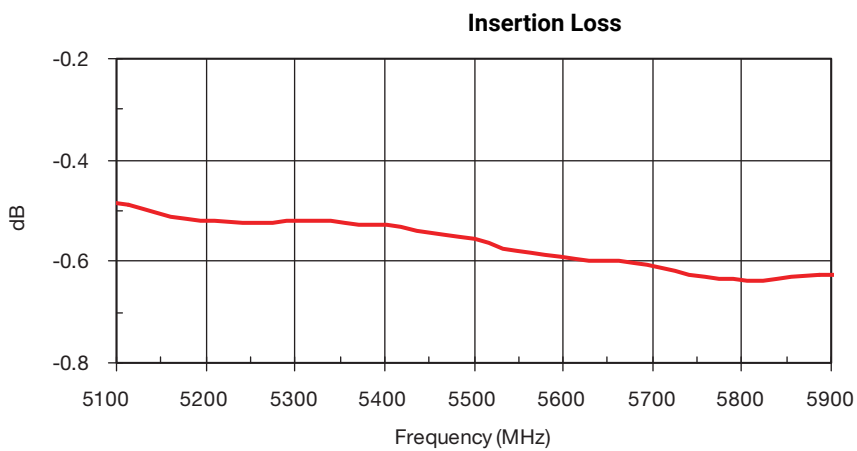
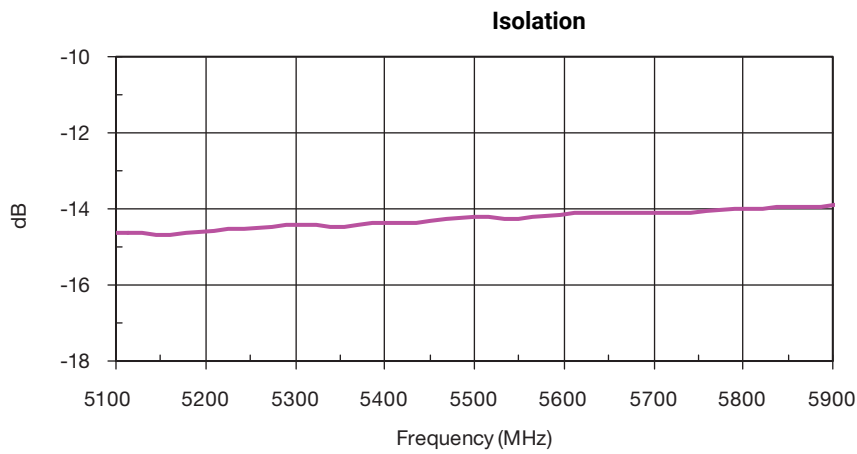
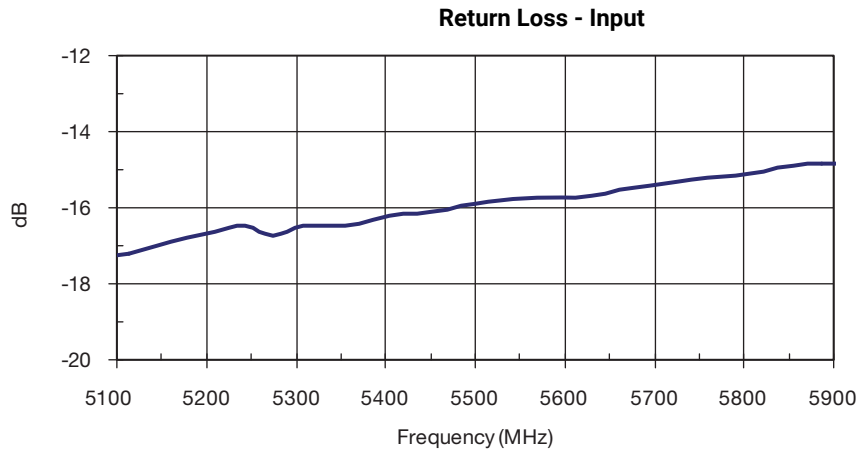

Thin-Film RF/Microwave Directional Couplers

CP0302/CP0402/CP0603/CP0805 and DB0603N/DB0805 3dB 90° DB0603N 3dB 90° Couplers



5100MHZ TO 5900MHZ DB0603N5500ANTR

Amplitude Balance

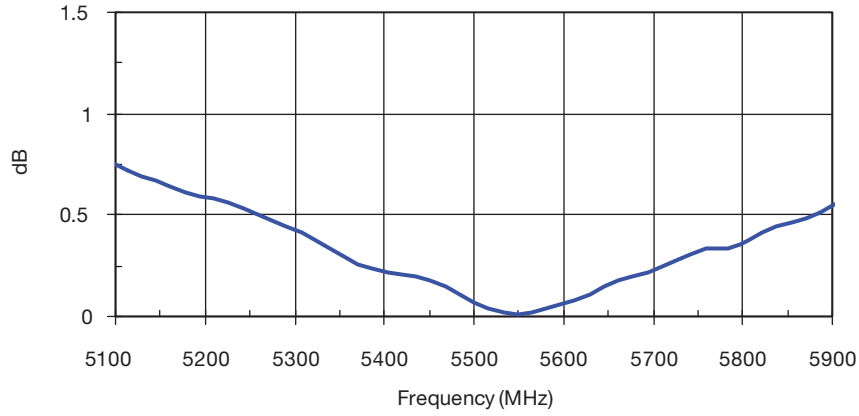

Phase Balance

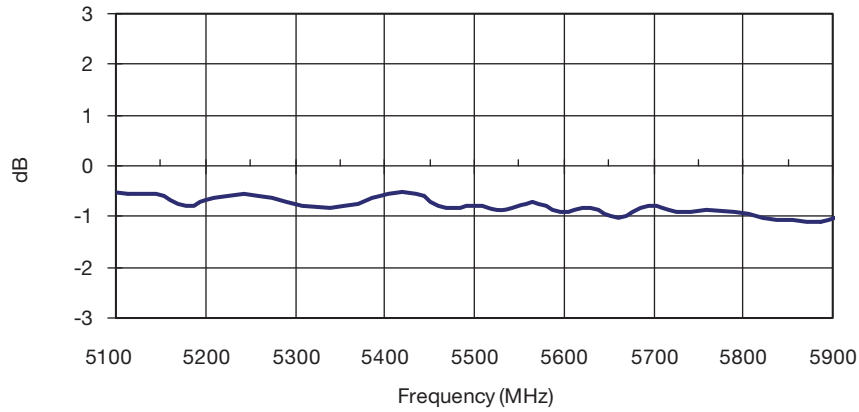

Thin-Film RF/Microwave Directional Couplers

CP0302/CP0402/CP0603/CP0805 and DB0603N/DB0805 3dB 90° DB0603N 3dB 90° Couplers



5600MHZ TO 6000MHZ DB0603N5800ANTR

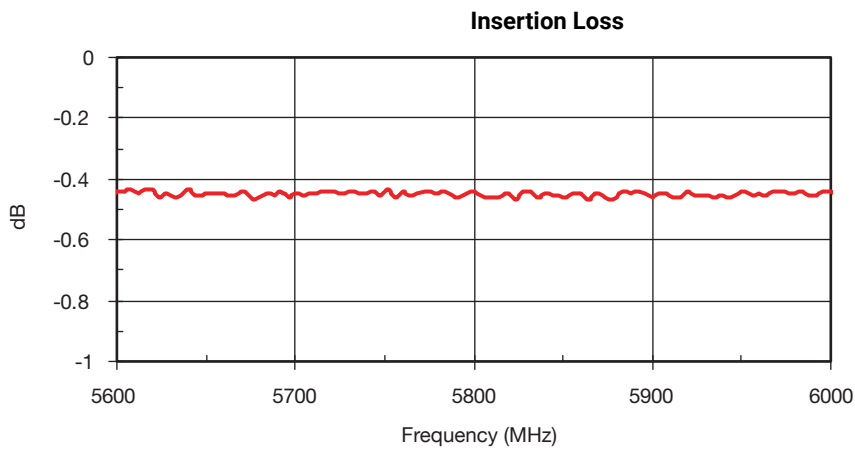
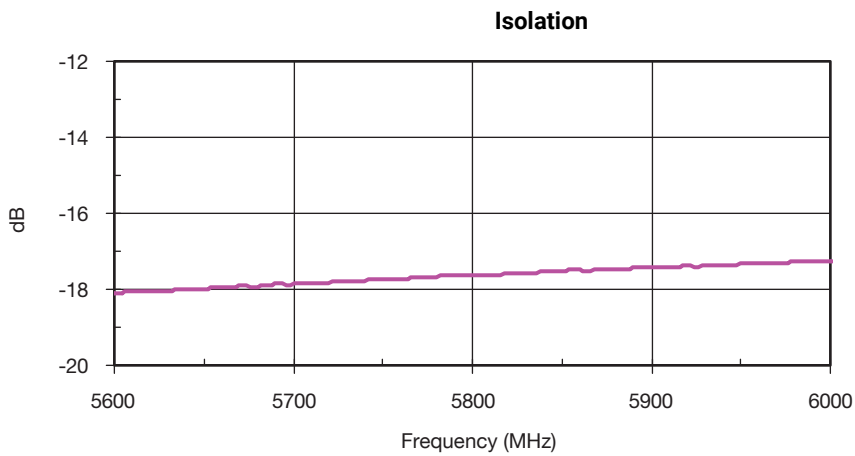
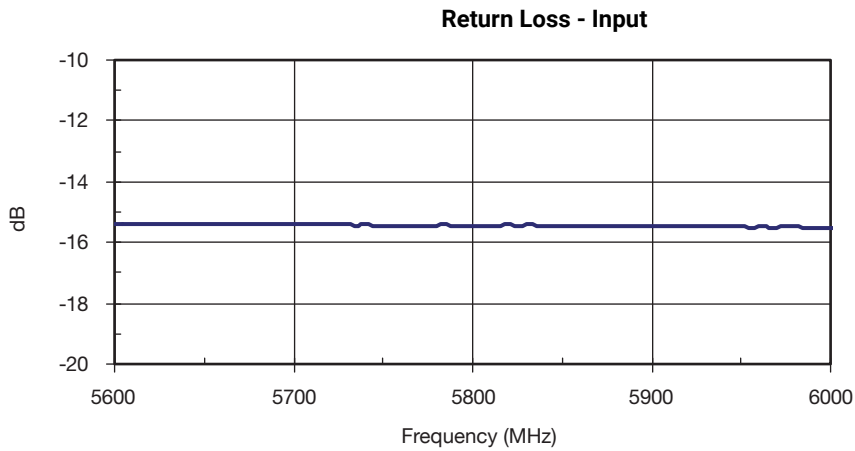

Thin-Film RF/Microwave Directional Couplers

CP0302/CP0402/CP0603/CP0805 and DB0603N/DB0805 3dB 90° DB0603N 3dB 90° Couplers



5600MHZ TO 6000MHZ DB0603N5800ANTR

Amplitude Balance

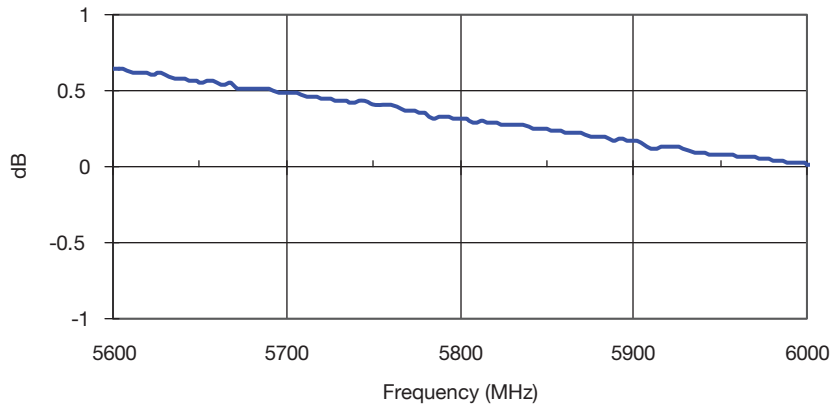

Phase Balance

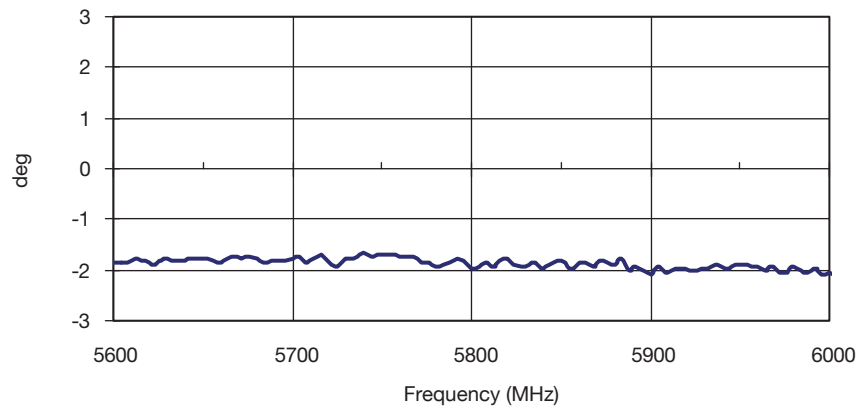

Thin-Film RF/Microwave Directional Couplers

CP0302/CP0402/CP0603/CP0805 and DB0603N/DB0805 3dB 90° DB0805 3dB 90° Couplers



GENERAL DESCRIPTION ITF TECHNOLOGY

The ITF SMD 3dB 90° Coupler is based on thin-film multilayer technology. The technology provides a miniature part with excellent high frequency performance and rugged construction for reliable automatic assembly.

The ITF 3dB 90° Coupler is offered in a variety of frequency bands compatible with various types of high frequency wireless systems.

APPLICATIONS

- Balanced Amplifiers and Signal Distribution in Mobile Communications

FEATURES

- Miniature 0805 size
- Low I. Loss
- High Isolation
- Power Handling: 10W RF CW
- Surface Mountable
- Supplied on Tape & Reel
- Operating Temperature -40°C to +85°C

RECOMMENDED PAD LAYOUT DIMENSIONS:

millimeters (inches)

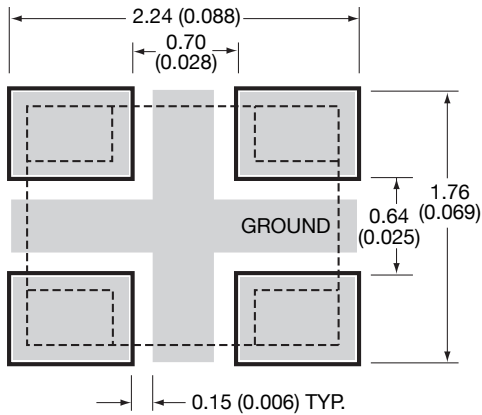

DIMENSIONS:

millimeters (inches)

L	2.03±0.10 (0.080±0.004)
W	1.55±0.10 (0.061±0.004)
T	0.98±0.15 (0.037±0.006)
A	0.56±0.25 (0.022±0.010)
B	0.35±0.15 (0.014±0.006)

BOTTOM VIEW

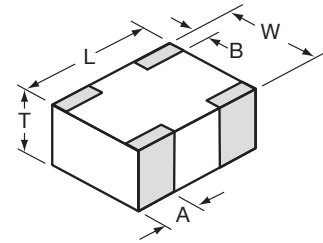

ELECTRICAL PARAMETERS*

Part Number**	Frequency FO [MHz]	I. Loss @ F _o [dB]	Phase Balance [deg] max.	Code Letter Marking
DB0805A0870ASTR	870±70	0.4	3	Y
DB0805A0880ASTR	880±30	0.35	3	Y
DB0805A0915ASTR	915±30	0.35	3	V
DB0805A0967ASTR	967±30	0.35	3	V
DB0805A1176ASTR	1176±13	0.2	3	G
DB0805A1350ASTR	1350±50	0.35	3	C
DB0805A1376ASTR	1376±211	0.6	8	G
DB0805A1650ASTR	1650±50	0.35	3	F
DB0805A1800ASTR	1800±50	0.30	3	F
DB0805A1850ASTR	1850±50	0.30	3	K
DB0805A1900ASTR	1900±50	0.30	3	K
DB0805A1950ASTR	1950±50	0.25	3	K
DB0805A2140ASTR	2140±50	0.25	3	L
DB0805A2325ASTR	2325±50	0.25	3	T

*With Recommended Pad Layout

NOTE: Additional Frequencies Available Upon Request

TERMINALS (TOP VIEW) ORIENTATION IN TAPE

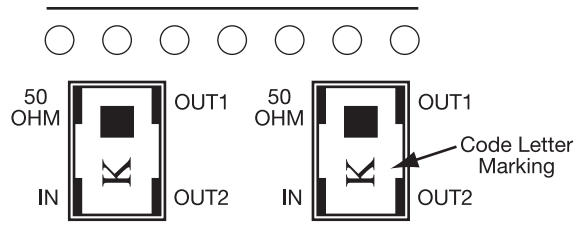

**LEAD FREE TERMINATION

PART NUMBERS:
DB0805AXXXASTR



Thin-Film RF/Microwave Directional Couplers

CP0302/CP0402/CP0603/CP0805 and DB0603N/DB0805 3dB 90°

DB0805 3dB 90° Couplers



870 ± 13MHZ DB0805A0870ASTR

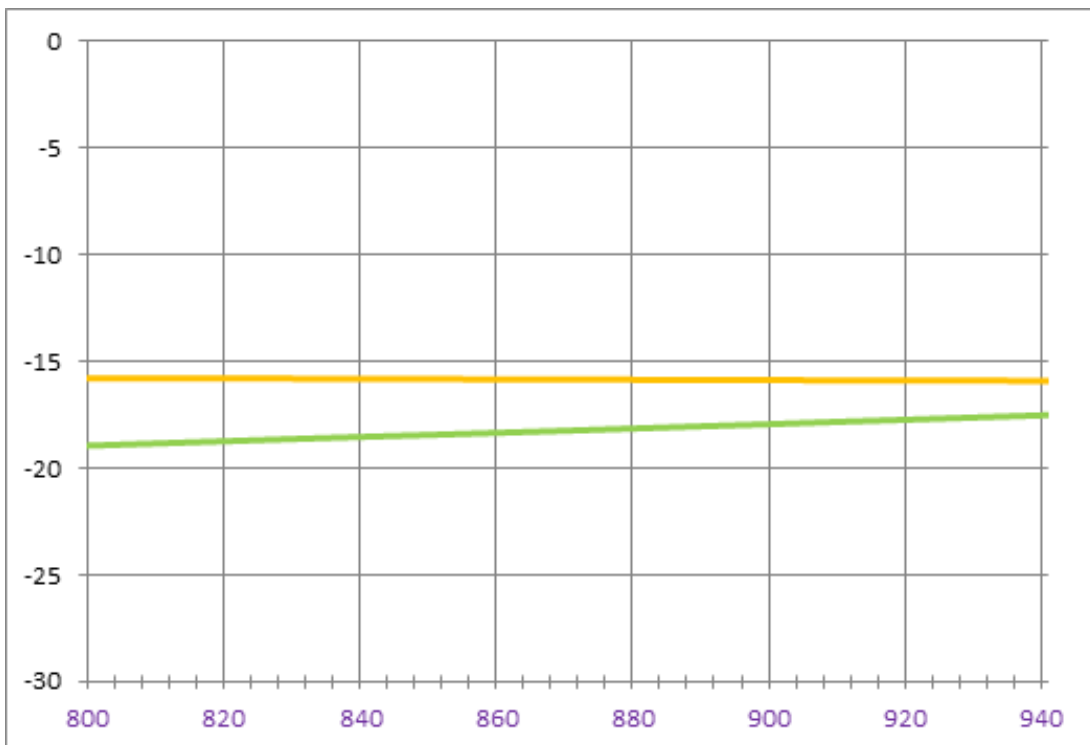
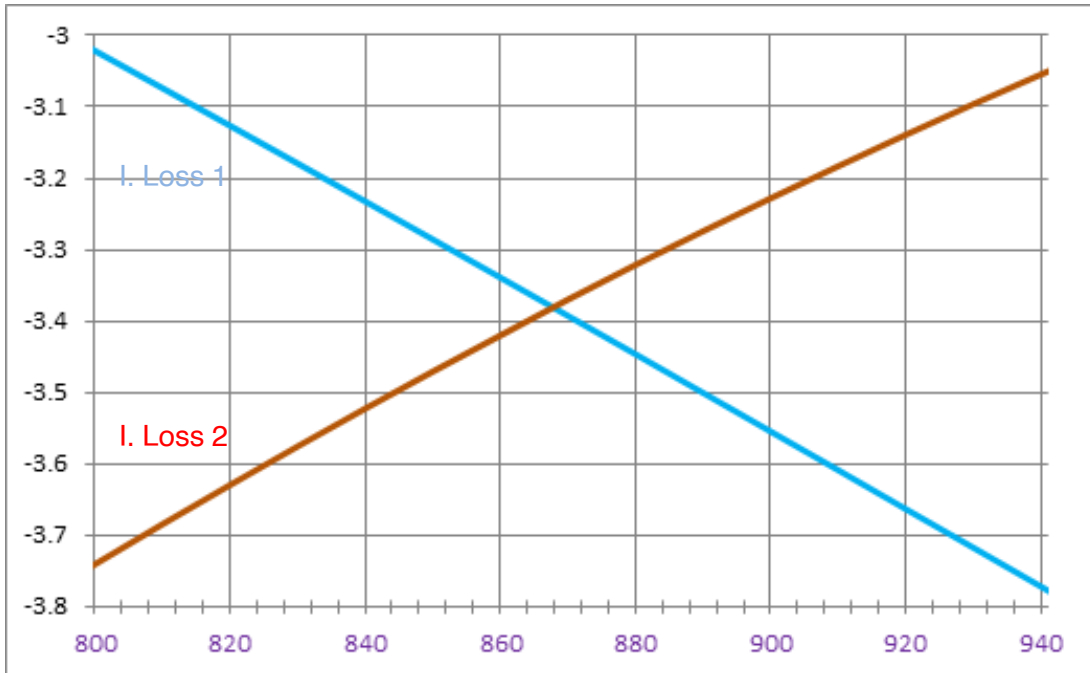

Thin-Film RF/Microwave Directional Couplers
CP0302/CP0402/CP0603/CP0805 and DB0603N/DB0805 3dB 90°
DB0805 3dB 90° Couplers



880 ± 30MHz DB0805A0880ASTR

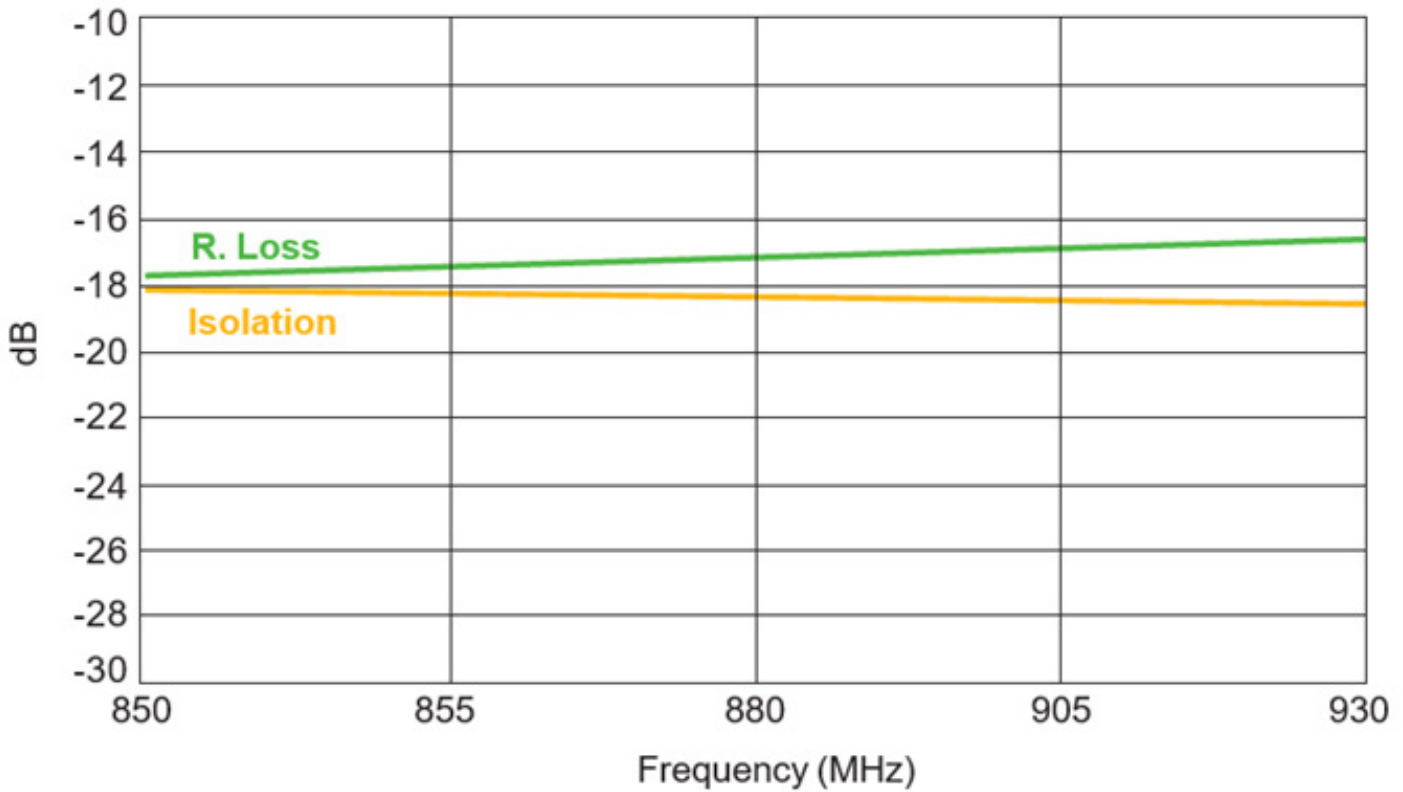
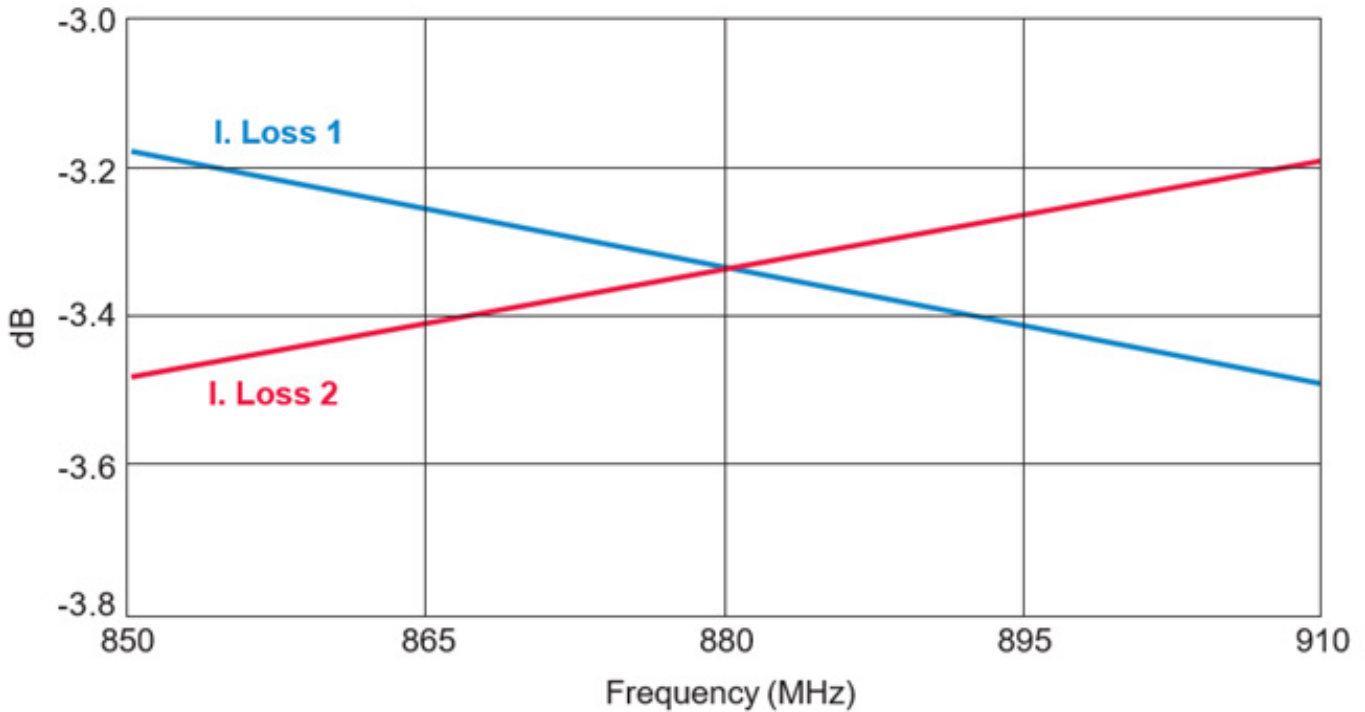

Thin-Film RF/Microwave Directional Couplers
CP0302/CP0402/CP0603/CP0805 and DB0603N/DB0805 3dB 90°
DB0805 3dB 90° Couplers



915 ± 30MHz DB0805A0915ASTR

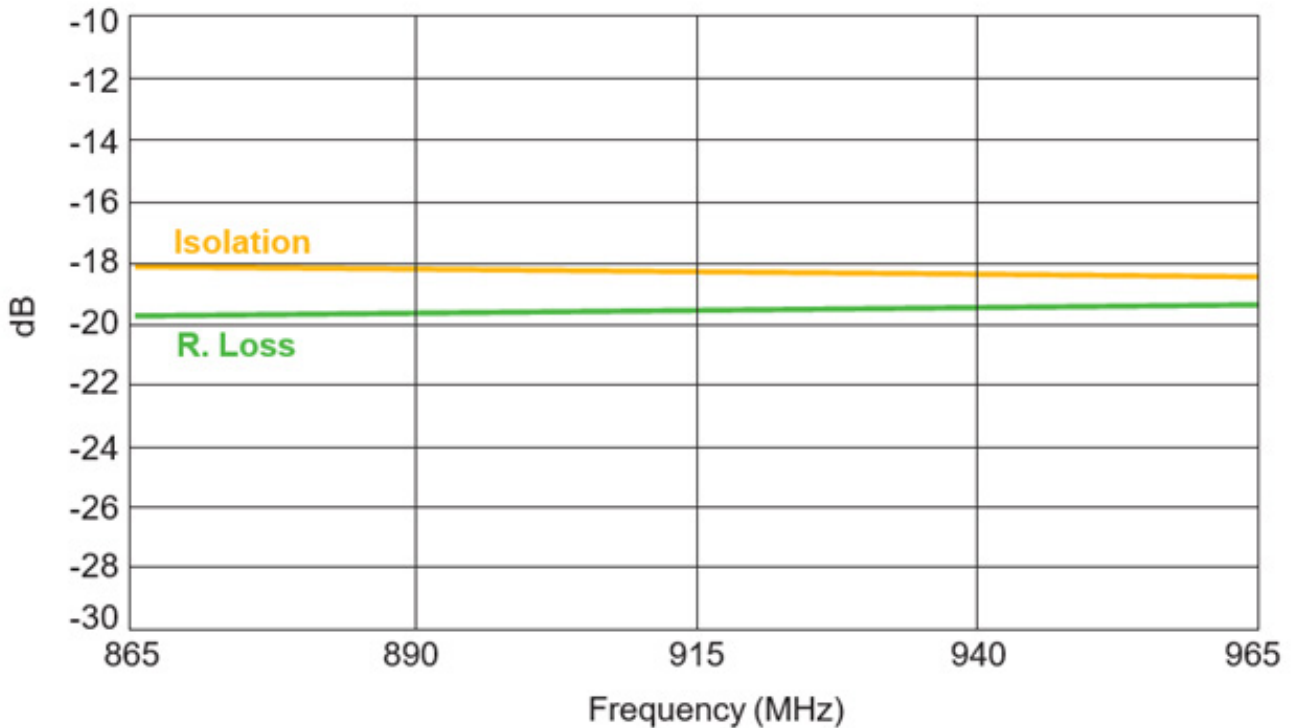
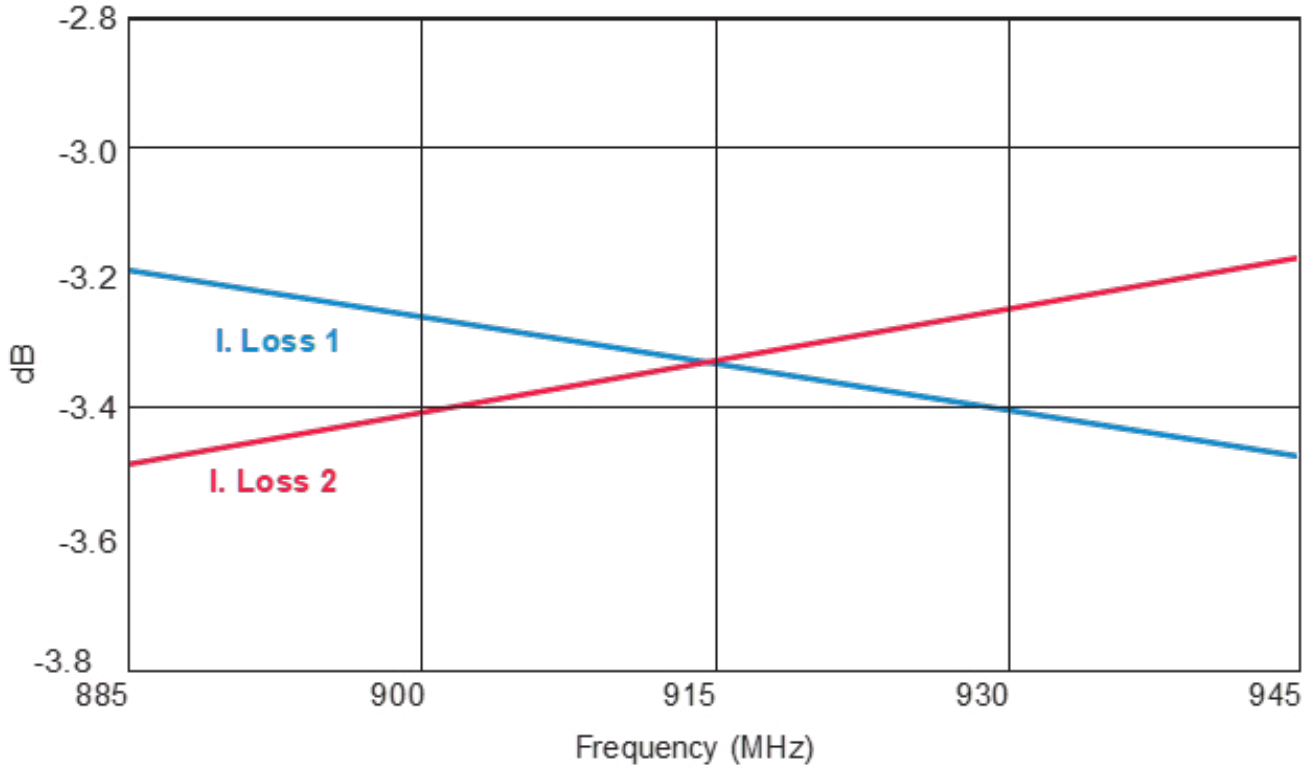

Thin-Film RF/Microwave Directional Couplers
CP0302/CP0402/CP0603/CP0805 and DB0603N/DB0805 3dB 90°
DB0805 3dB 90° Couplers



967± 30MHZ DB0805A0967ASTR

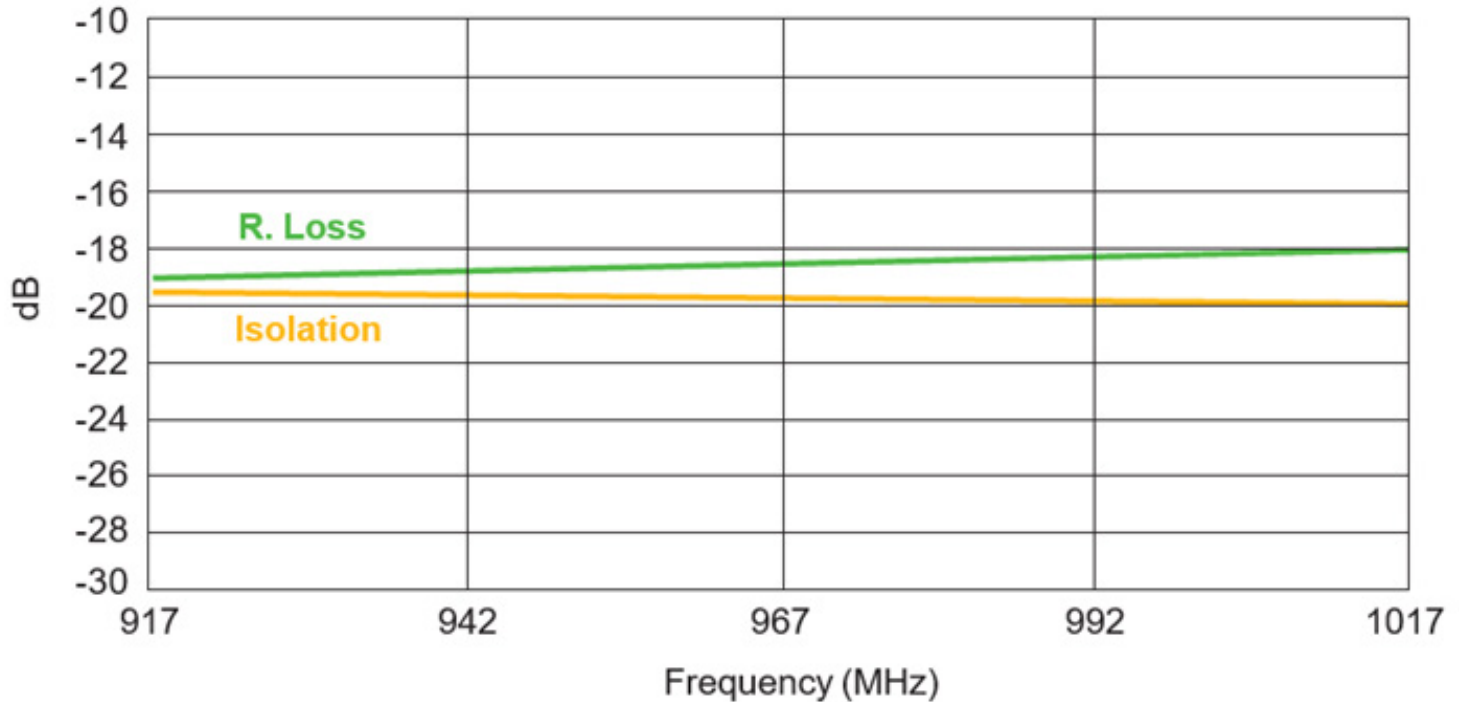
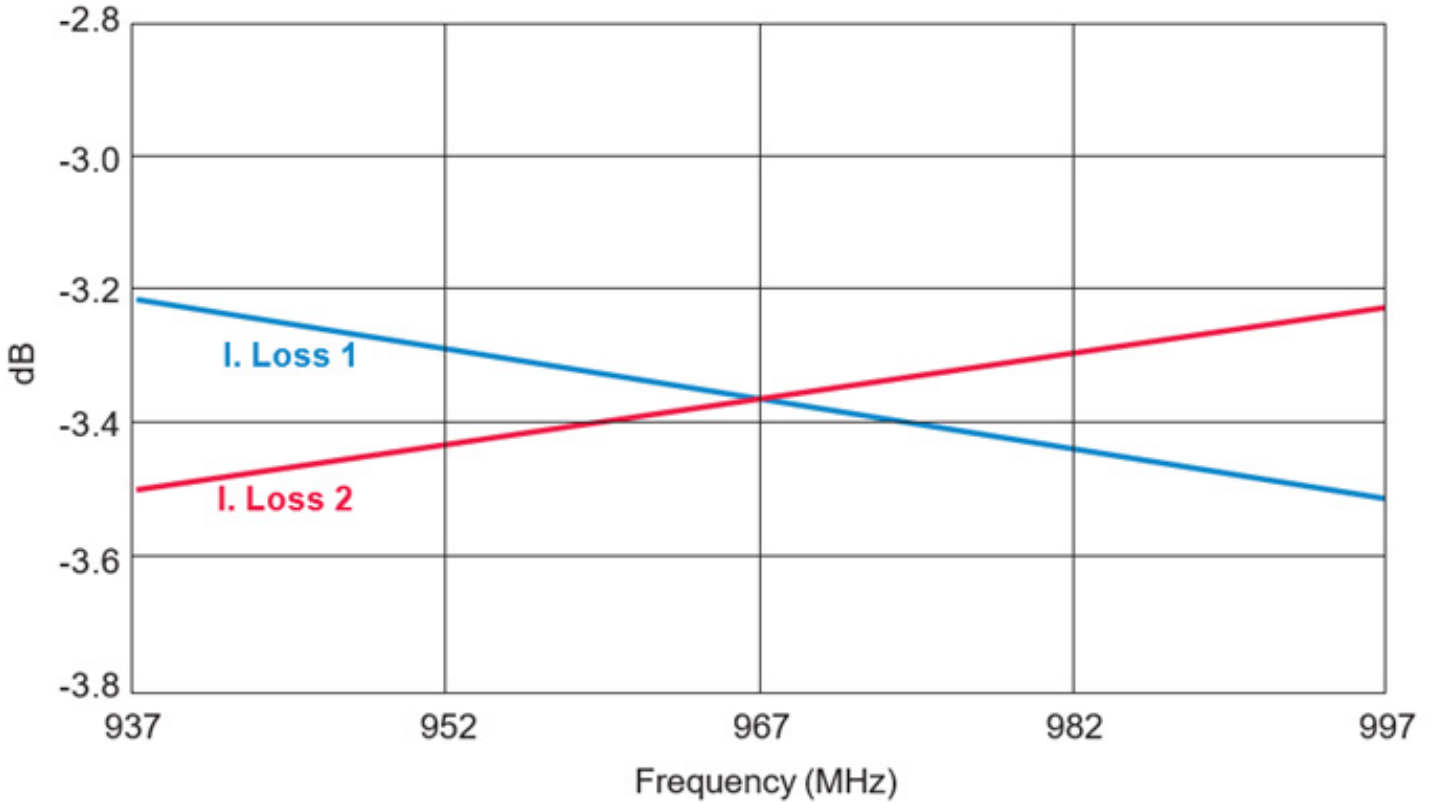

Thin-Film RF/Microwave Directional Couplers

CP0302/CP0402/CP0603/CP0805 and DB0603N/DB0805 3dB 90°

DB0805 3dB 90° Couplers



11760 ± 13MHZ DB0805A176ASTR (L1 BAND)

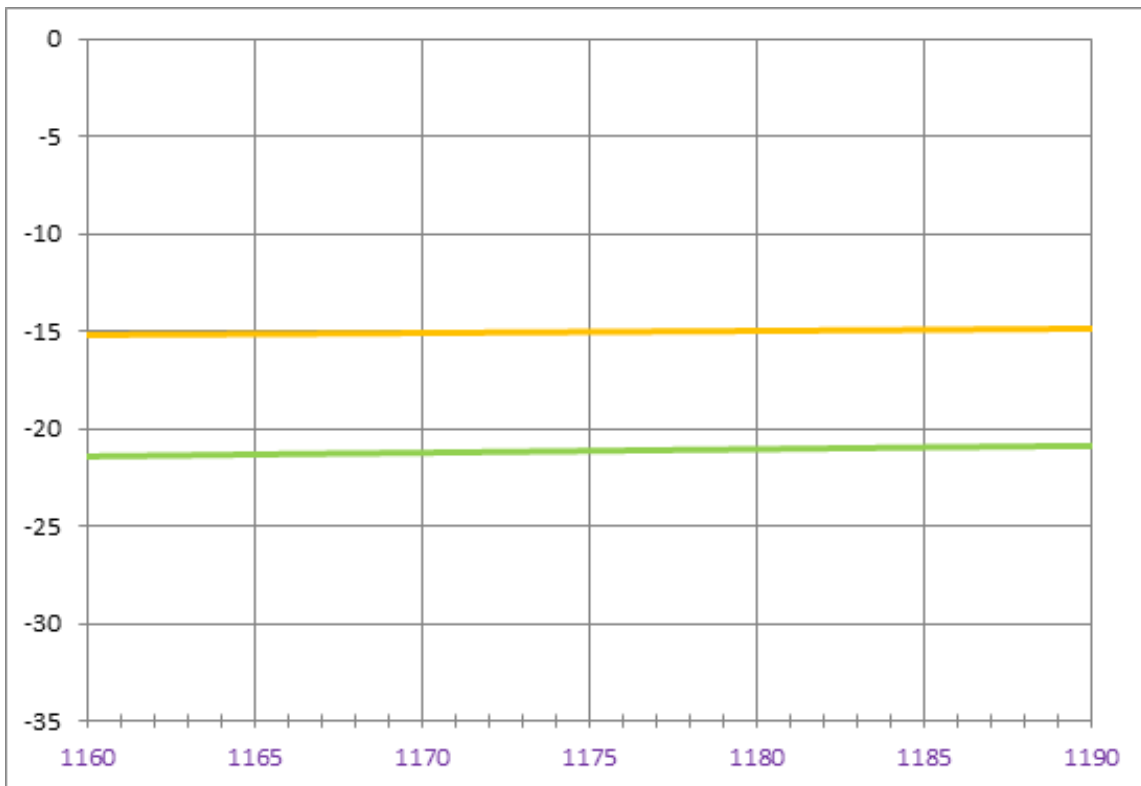
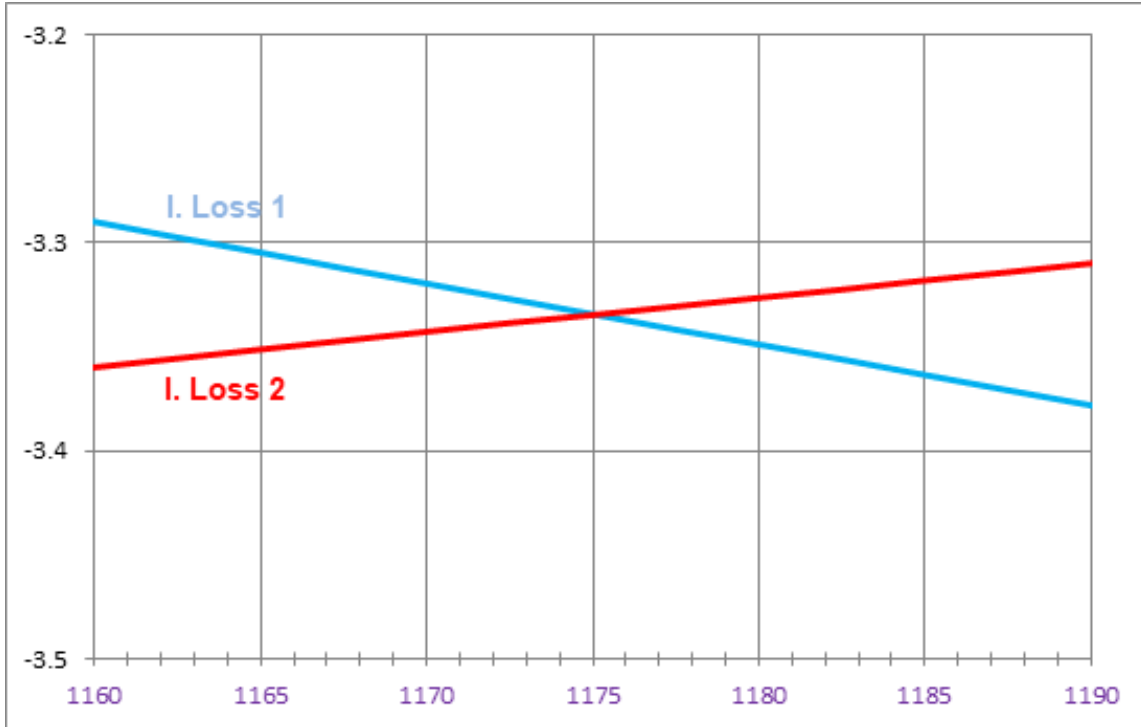

Thin-Film RF/Microwave Directional Couplers
CP0302/CP0402/CP0603/CP0805 and DB0603N/DB0805 3dB 90°
DB0805 3dB 90° Couplers



1350 ± 50MHz DB0805A1350ASTR

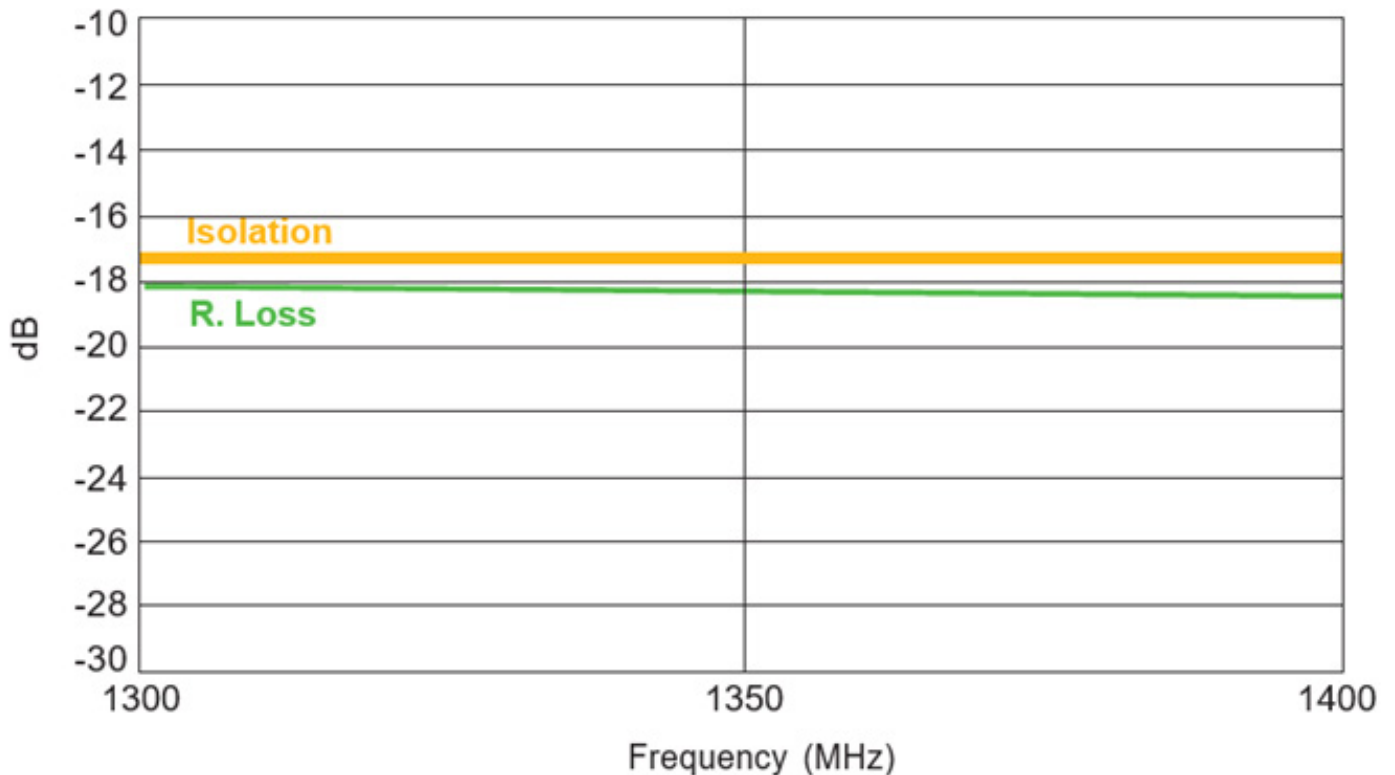
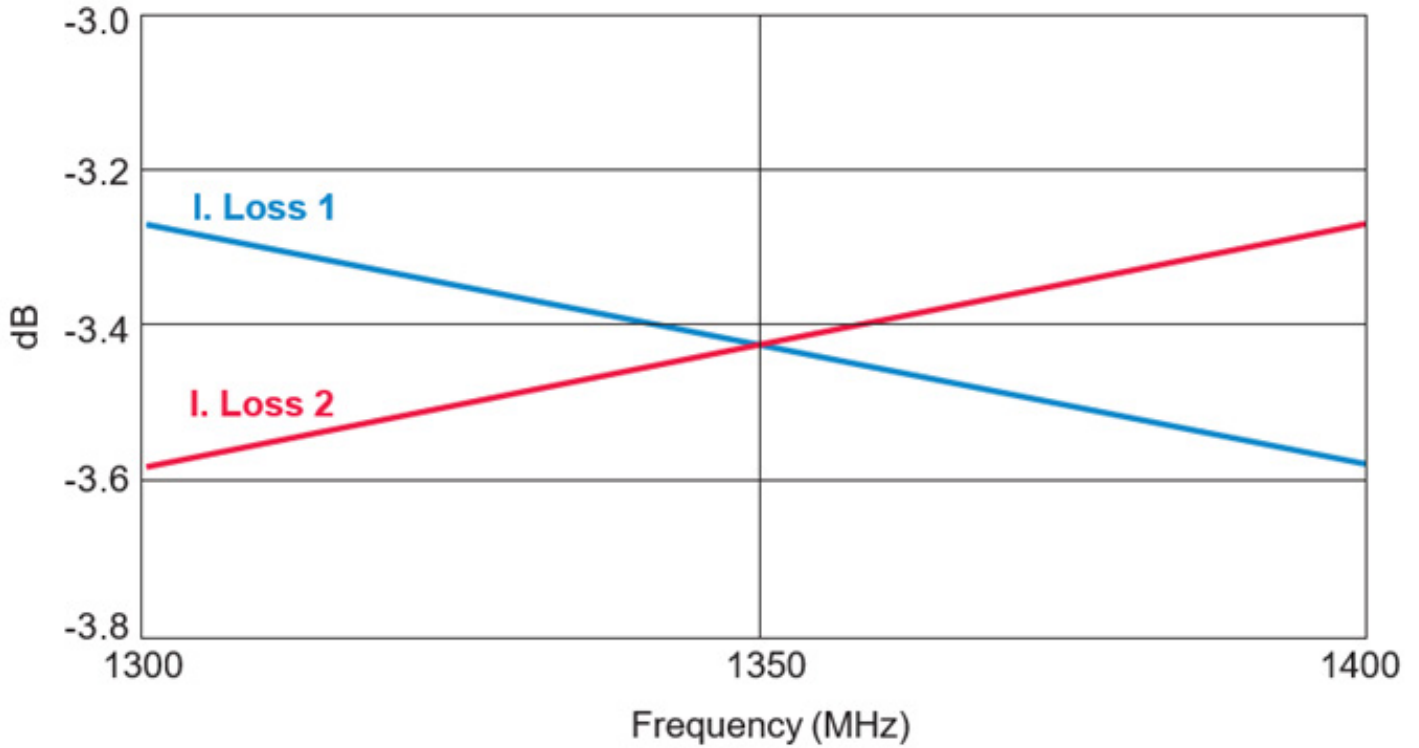

Thin-Film RF/Microwave Directional Couplers

CP0302/CP0402/CP0603/CP0805 and DB0603N/DB0805 3dB 90°

DB0805 3dB 90° Couplers



1376 ± 210 MHZ DB0805A1376ASTR (L5 BAND)

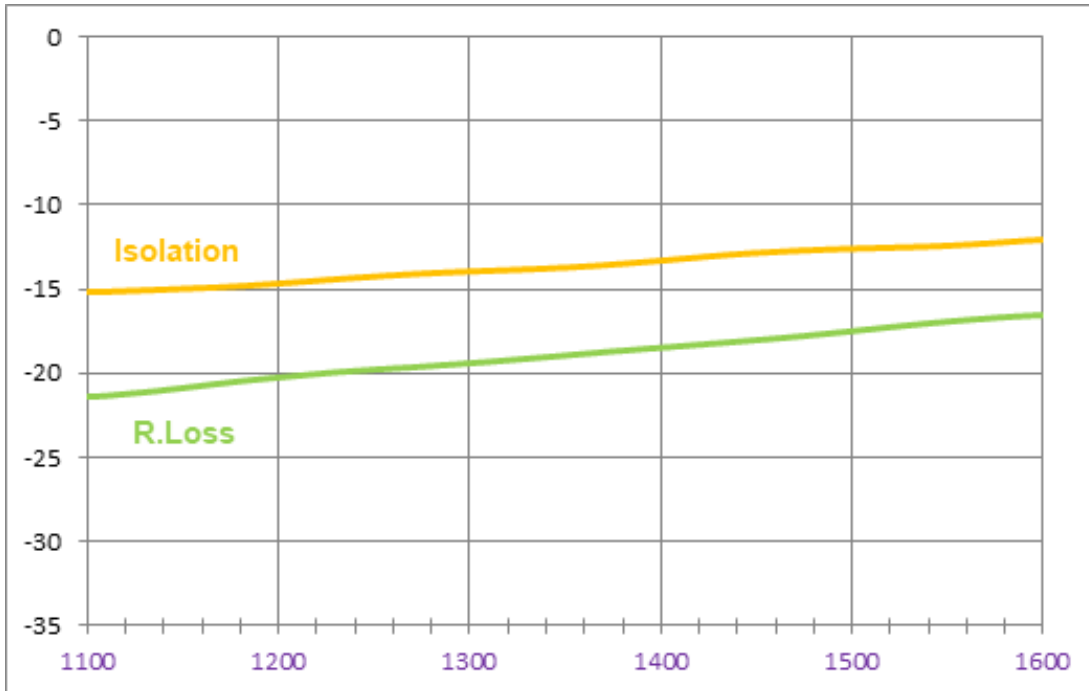
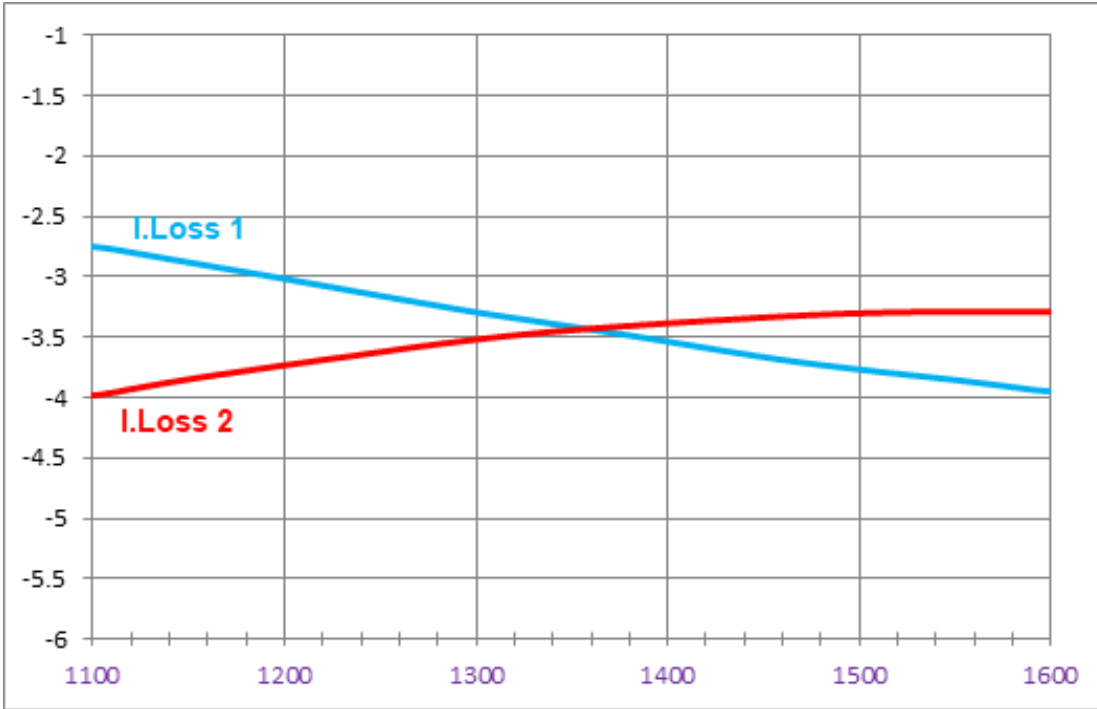

Thin-Film RF/Microwave Directional Couplers
CP0302/CP0402/CP0603/CP0805 and DB0603N/DB0805 3dB 90°
DB0805 3dB 90° Couplers



1650 ± 50MHz DB0805A1650ASTR

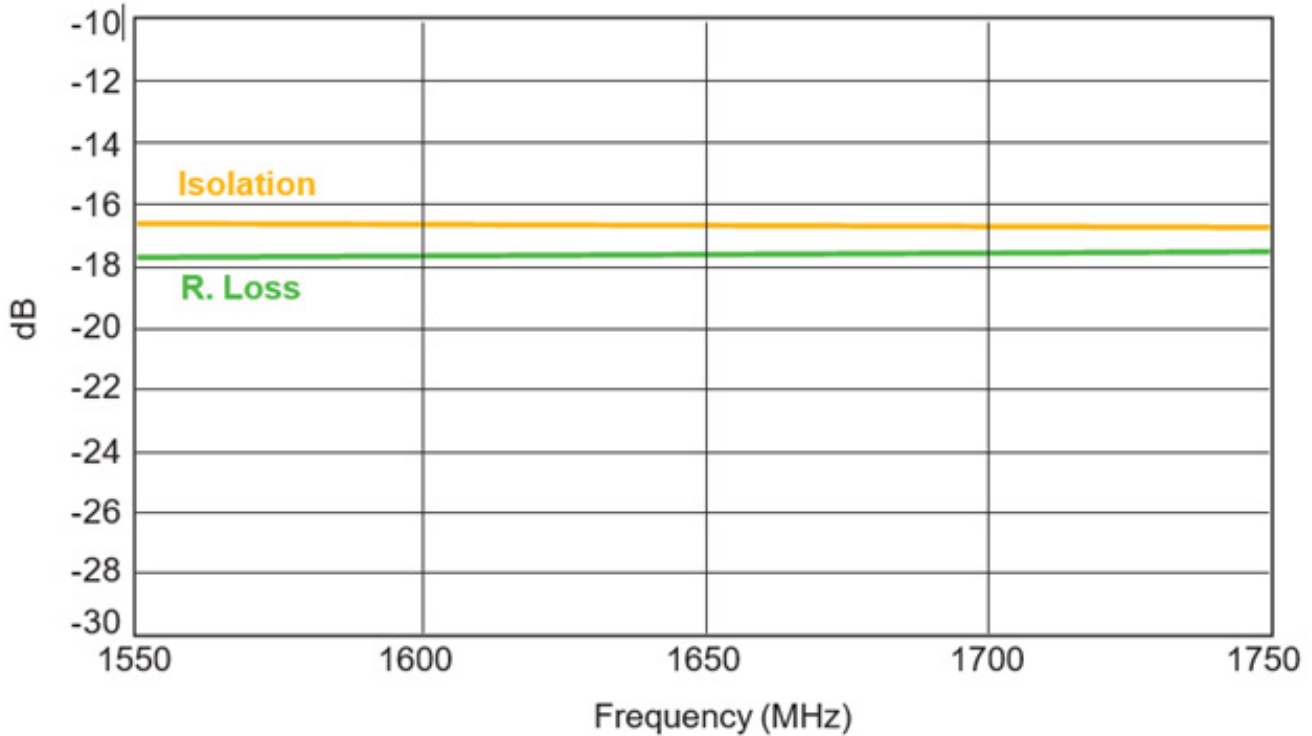
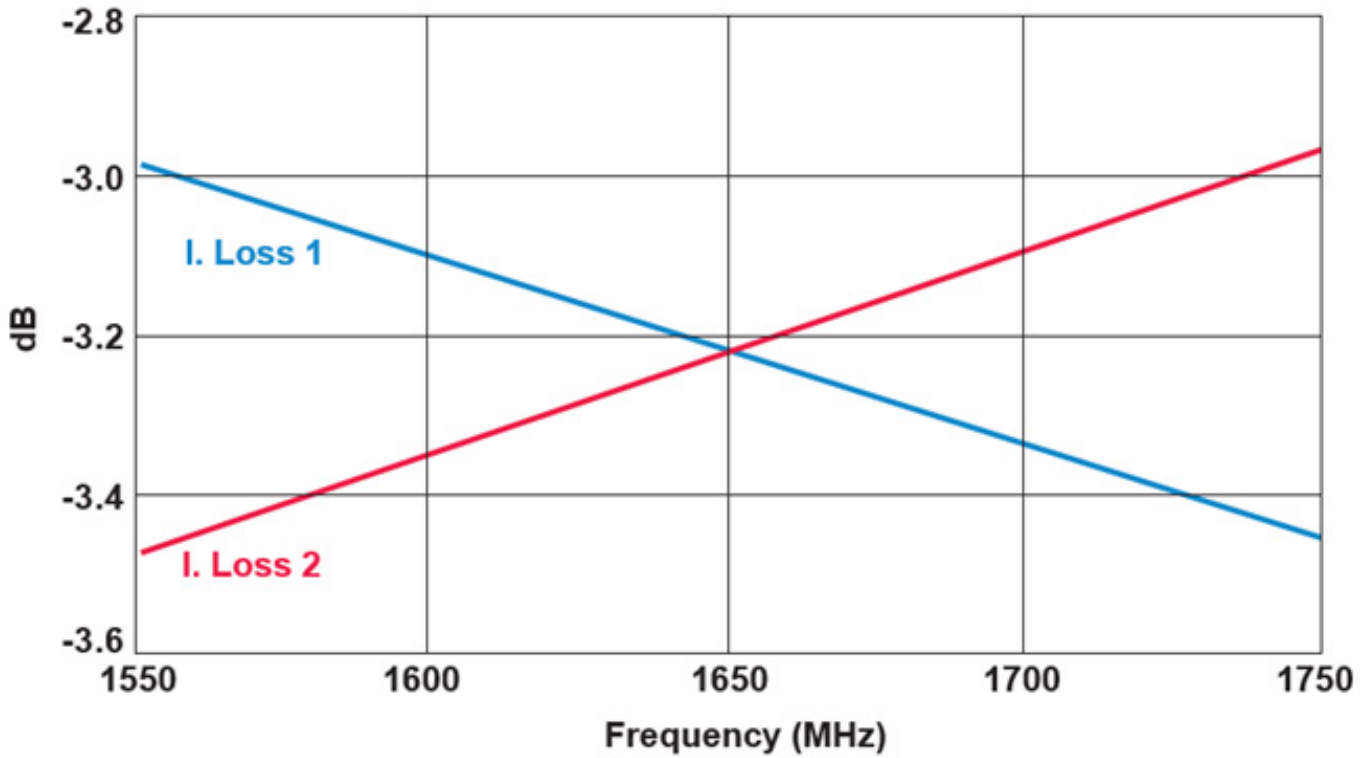

Thin-Film RF/Microwave Directional Couplers
CP0302/CP0402/CP0603/CP0805 and DB0603N/DB0805 3dB 90°
DB0805 3dB 90° Couplers



1800 ± 50MHz DB0805A1800ASTR

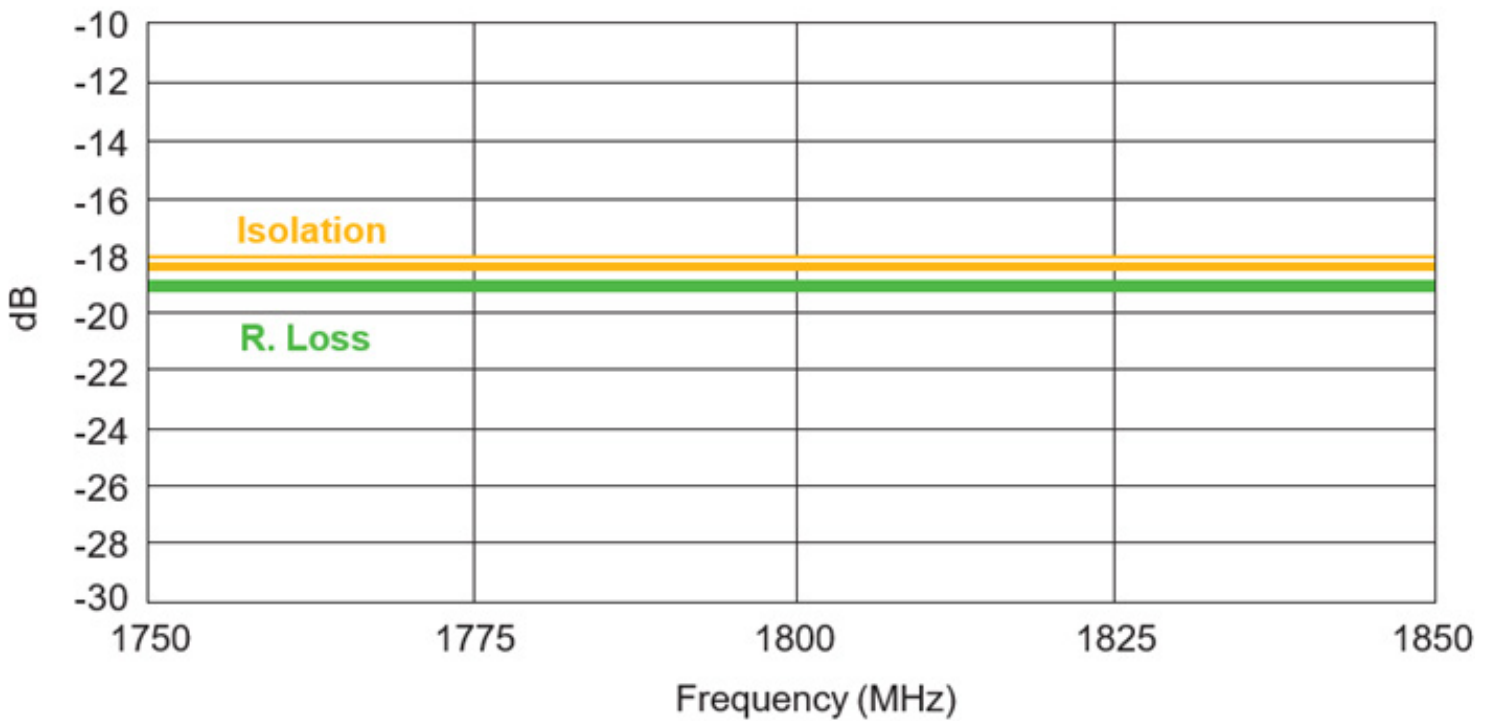
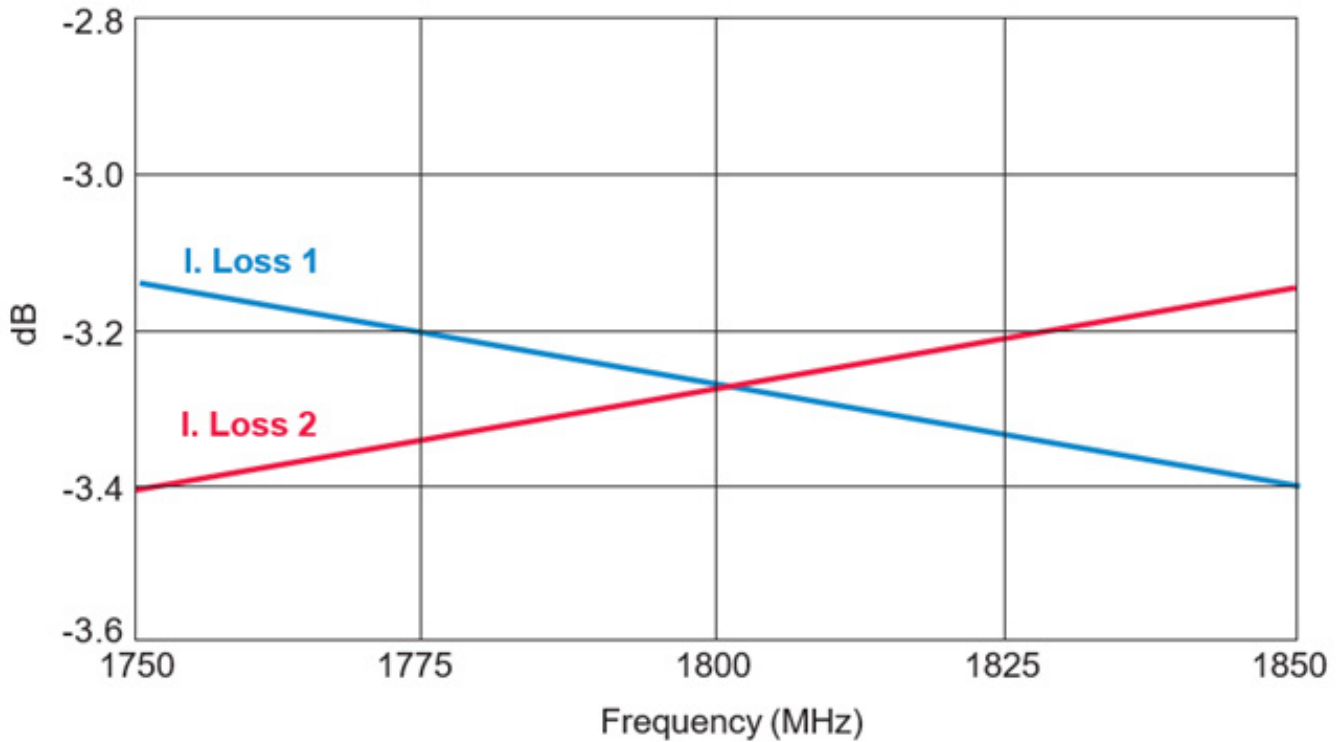

Thin-Film RF/Microwave Directional Couplers

CP0302/CP0402/CP0603/CP0805 and DB0603N/DB0805 3dB 90° DB0805 3dB 90° Couplers



1850 ± 50MHz DB0805A1850ASTR

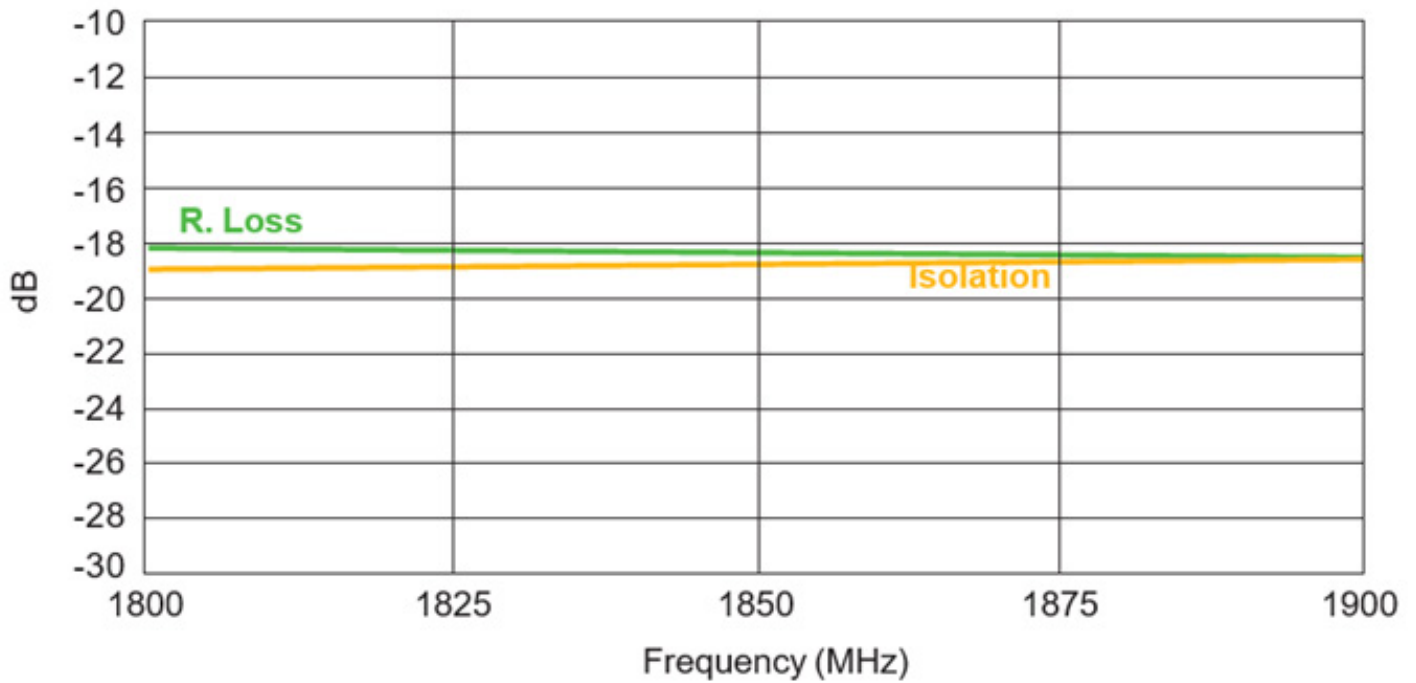
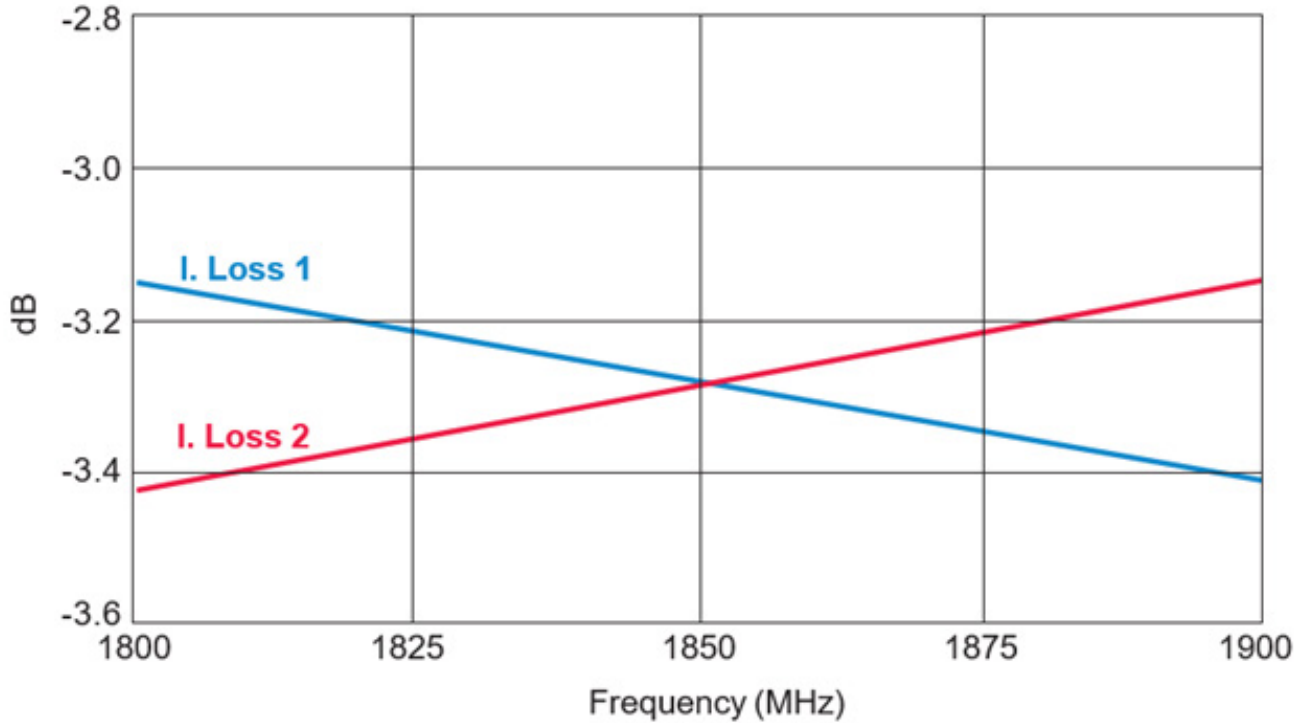

Thin-Film RF/Microwave Directional Couplers
CP0302/CP0402/CP0603/CP0805 and DB0603N/DB0805 3dB 90°
DB0805 3dB 90° Couplers



1900 ± 50MHz DB0805A1900ASTR

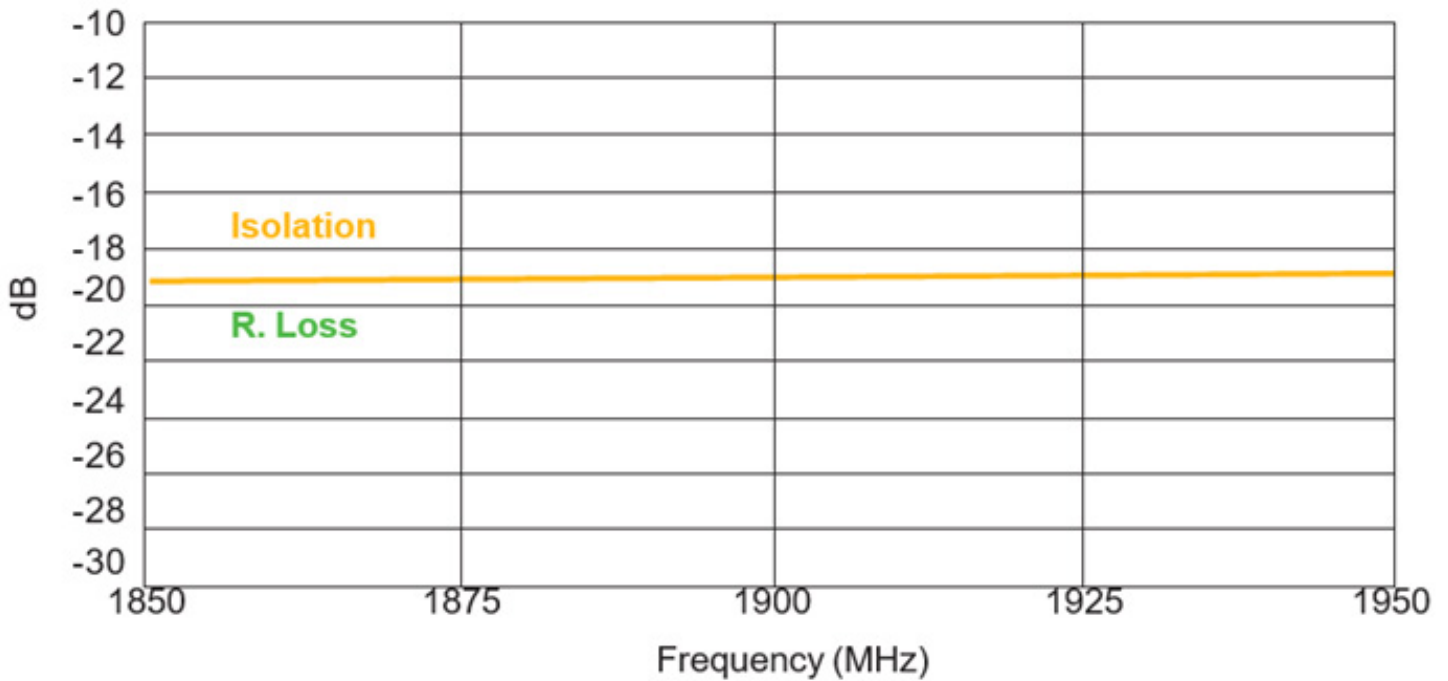
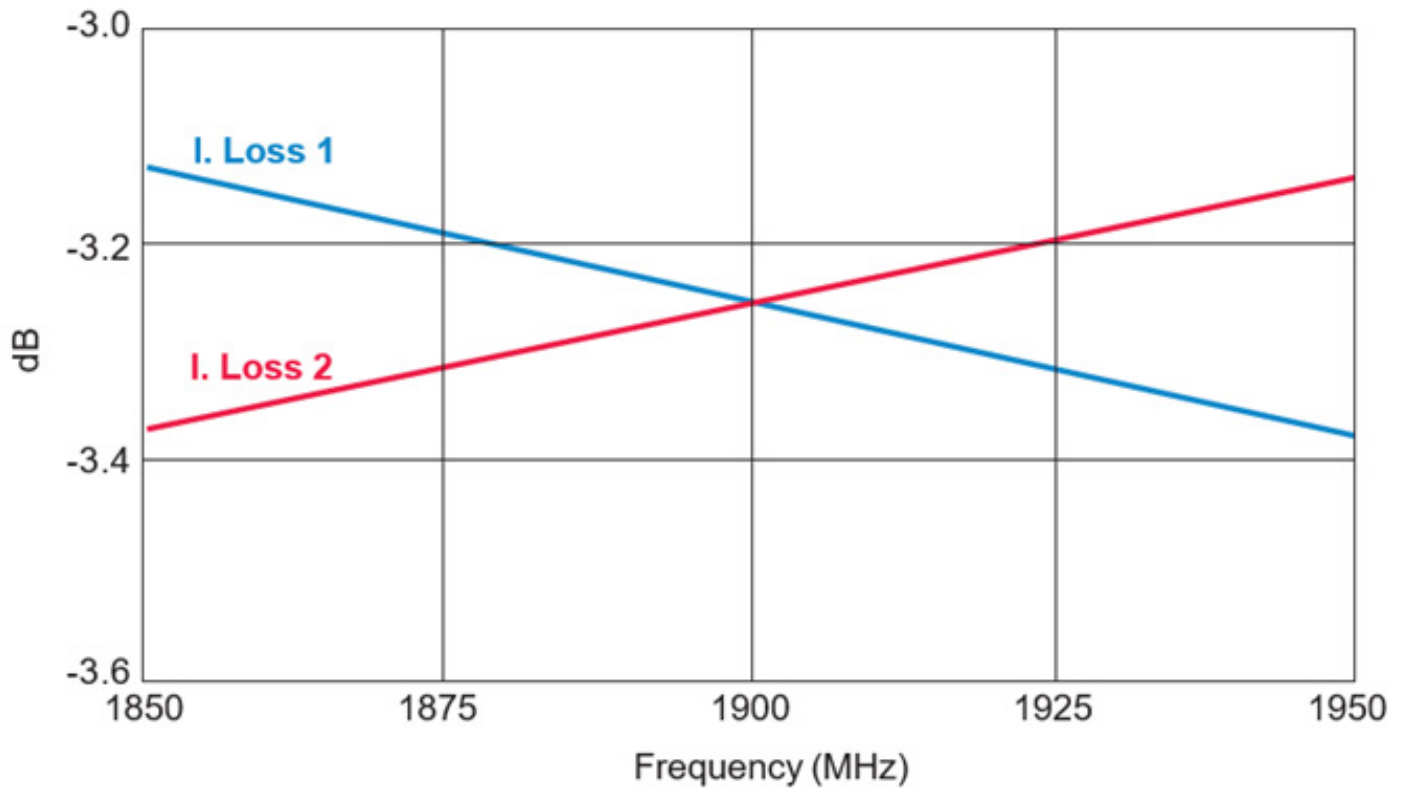

Thin-Film RF/Microwave Directional Couplers
CP0302/CP0402/CP0603/CP0805 and DB0603N/DB0805 3dB 90°
DB0805 3dB 90° Couplers



1950 ± 50MHz DB0805A1950ASTR

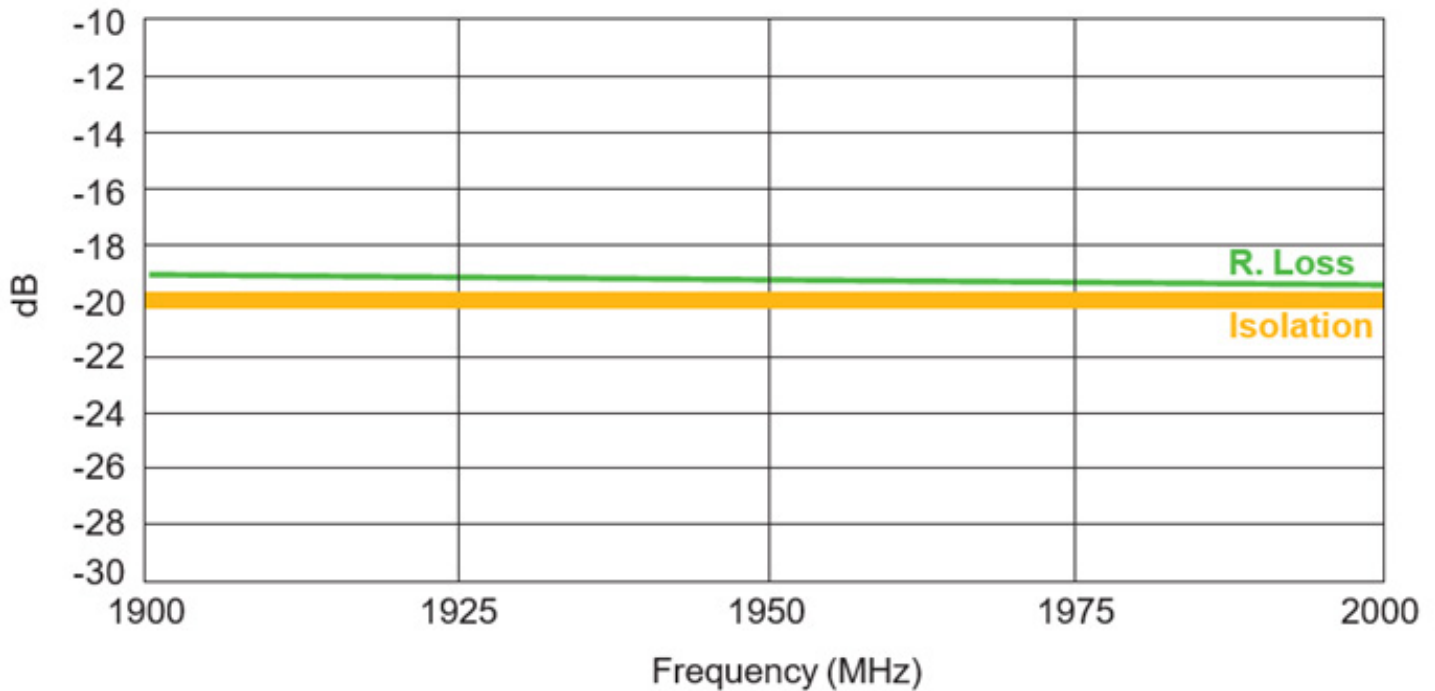
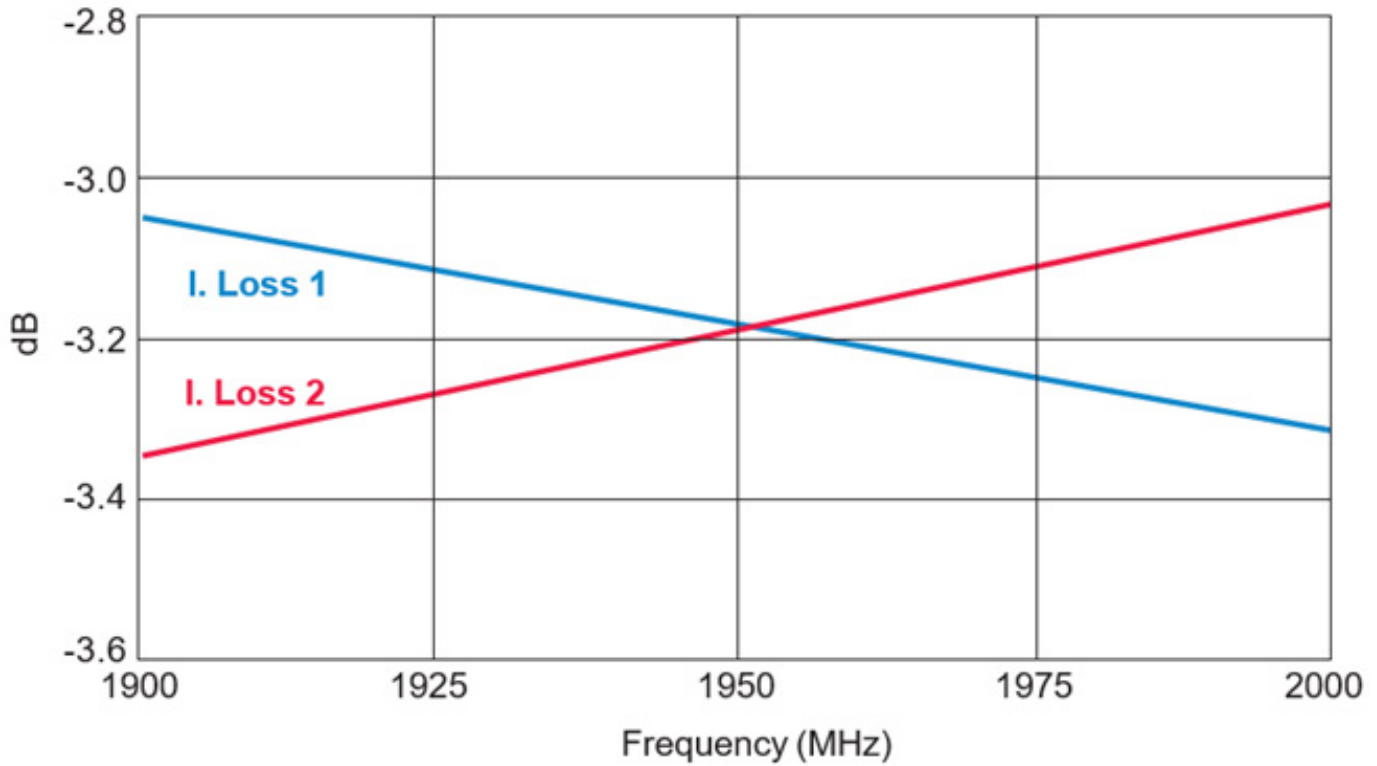

Thin-Film RF/Microwave Directional Couplers
CP0302/CP0402/CP0603/CP0805 and DB0603N/DB0805 3dB 90°
DB0805 3dB 90° Couplers



2140 ± 50MHz DB0805A2140ASTR

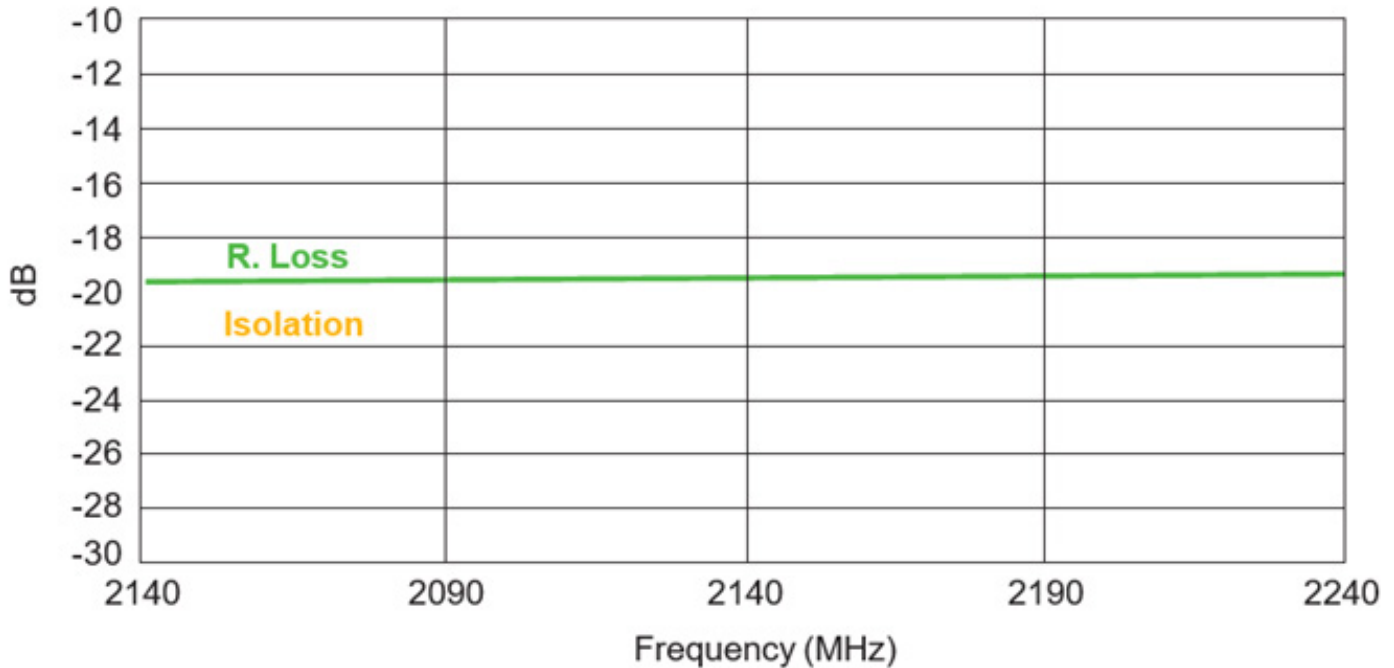
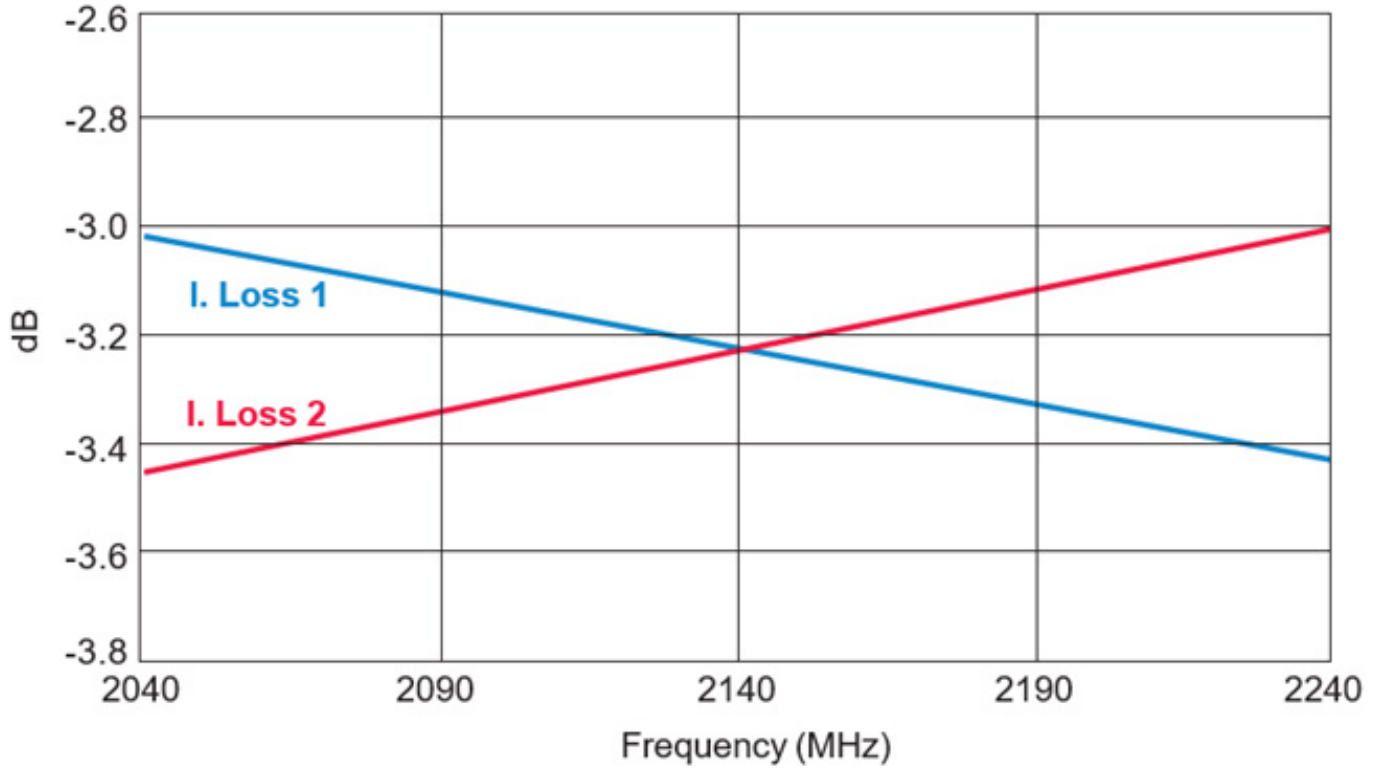

Thin-Film RF/Microwave Directional Couplers
CP0302/CP0402/CP0603/CP0805 and DB0603N/DB0805 3dB 90°
DB0805 3dB 90° Couplers



2325 ± 50MHz DB0805A2325ASTR

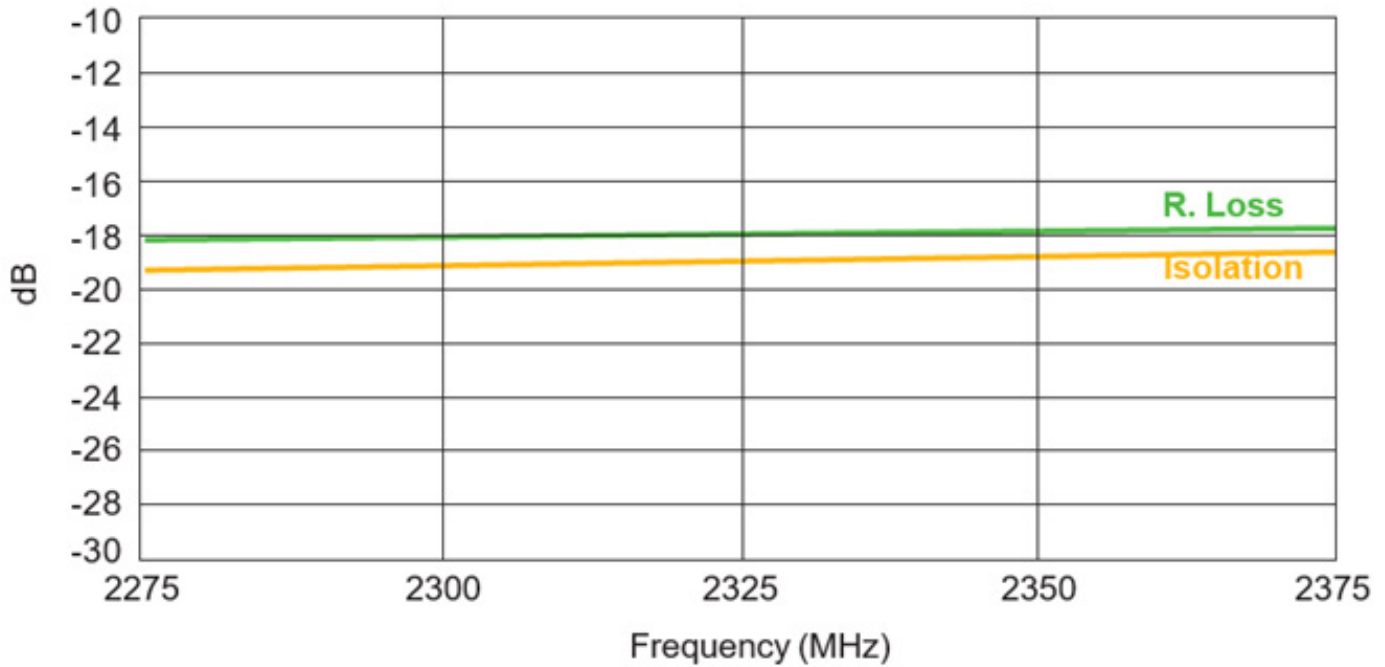
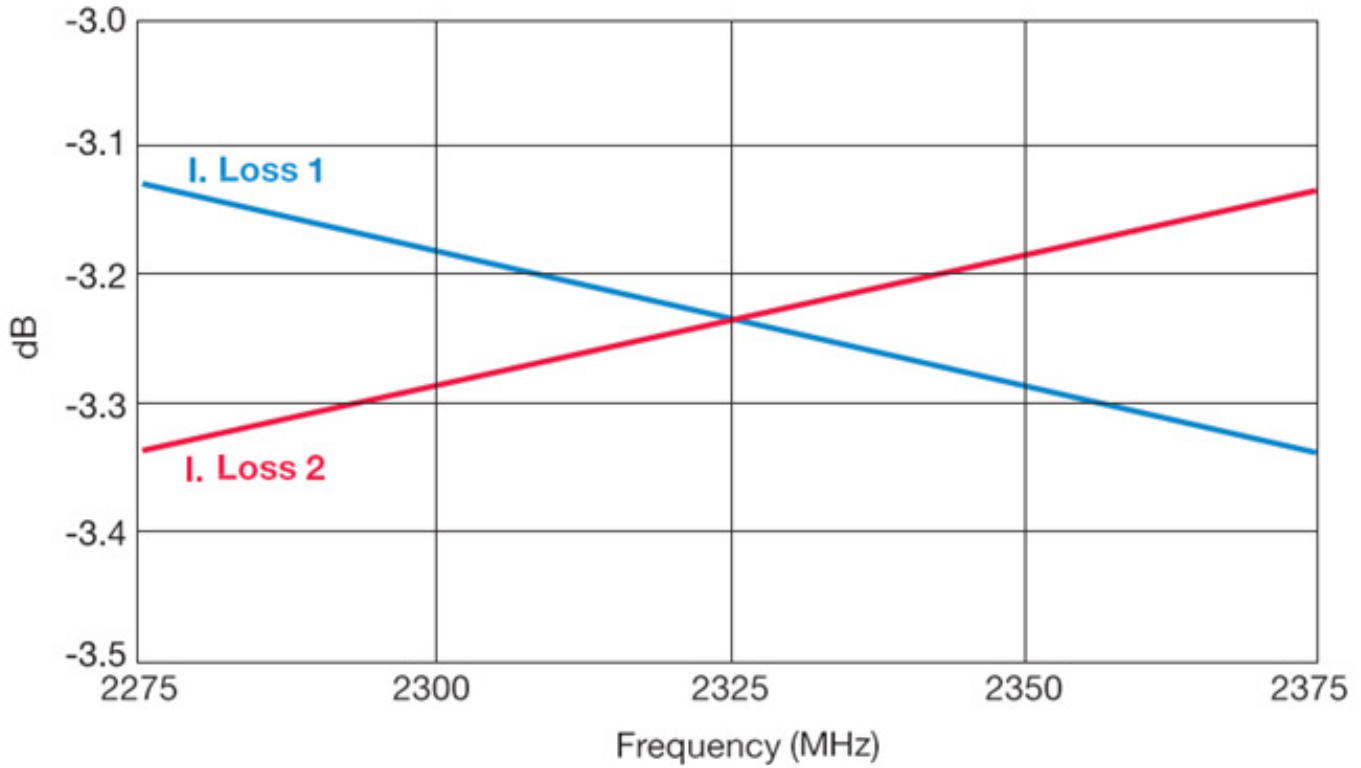

Thin-Film RF/Microwave Directional Couplers

CP0302/CP0402/CP0603/CP0805 and DB0603N/DB0805 3dB 90° DB0805 3dB 90° Couplers



GENERAL DESCRIPTION

These jigs are designed for testing the DB0805 3dB 90° Couplers using a Vector Network Analyzer.

They consist of a dielectric substrate, having 50Ω microstrips as conducting lines and a bottom ground plane located at a distance of 0.254mm from the microstrips.

The substrate used is Neltec's NH9338ST0254C1BC.

The connectors are SMA type (female), 'Johnson Components Inc.' Product

non-metallic stick until all four ports touch the appropriate pads.

Set the VNA to the relevant frequency band. Connect the VNA using a 10dB attenuator on the jig terminal connected to port 2. Follow the VNA's instruction manual and use the [calibration jwwig](#) to perform a full 2-port calibration in the required bandwidths.

P/N: 142-0701-841.

Both a measurement jig and a calibration jig are provided.

The calibration jig is designed for a full 2-port calibration, and consists of an open line, short line and through line. LOAD calibration can be done by a 50Ω SMA termination.

MEASUREMENT PROCEDURE

When measuring a component, it can be either soldered or pressed using a

Place the coupler on the **measurement jig** as follows:

Input (Coupler) ▶ Connector 1 (Jig) Output 1 (Coupler) ▶ Connector 3 (Jig)
 50Ω (Coupler) ▶ Connector 2 (Jig) Output 2 (Coupler) ▶ Connector 4 (Jig)

To measure **R. Loss** and **I. Loss 1** connect:

Connector 1 (Jig) ▶ Port 1 (VNA) Connector 3 (Jig) ▶ Port 2 (VNA)
 Connector 2 (Jig) ▶ 50Ω Connector 4 (Jig) ▶ 50Ω

To measure **R. Loss** and **I. Loss 2** connect:

Connector 1 (Jig) ▶ Port 1 (VNA) Connector 3 (Jig) ▶ 50Ω
 Connector 2 (Jig) ▶ 50Ω Connector 4 (Jig) ▶ Port 2 (VNA)

To measure **Isolation** connect:

Connector 1 (Jig) ▶ 50Ω Connector 3 (Jig) ▶ Port 1 (VNA)
 Connector 2 (Jig) ▶ 50Ω Connector 4 (Jig) ▶ Port 2 (VNA)

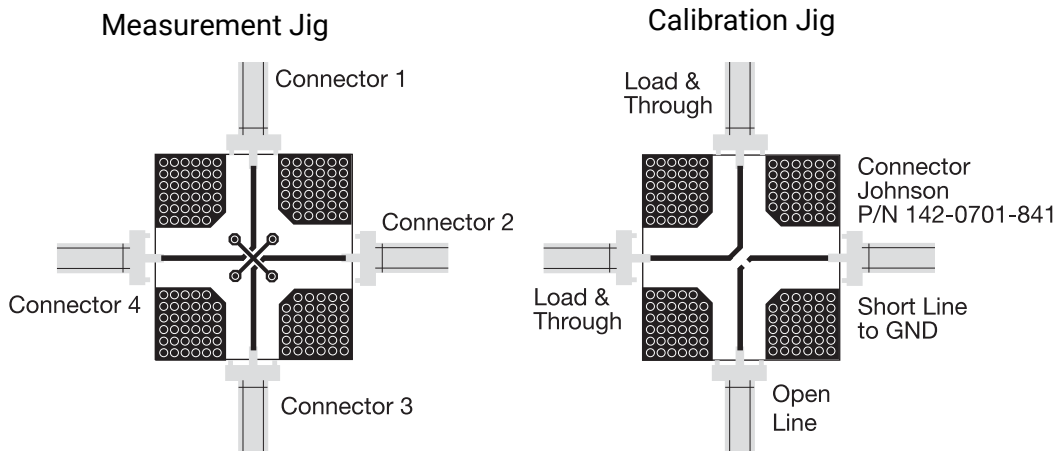



Thin-Film RF Filters

LP0402/LP0603/LP0805

Thin-Film RF/Microwave Filters

Low Pass – Harmonic Lead-Free

LP0402N Series – LGA Termination



RFAP TECHNOLOGY

The LP0402N Series Harmonic Low Pass Filter is based on the proprietary RFAP Thin-Film multilayer technology. The technology provides a miniature part with excellent high frequency performance and rugged construction for reliable automatic assembly.

The RFAP Harmonic Low Pass Filter is offered in a variety of frequency bands compatible with various types of high frequency wireless systems.

APPLICATIONS

- Wireless communications
- Wireless LAN's
- GPS
- WiMAX

LAND GRID ARRAY ADVANTAGES

- Inherent Low Profile
- Self Alignment during Reflow
- Excellent Solderability
- Low Parasitics
- Better Heat Dissipation

HOW TO ORDER

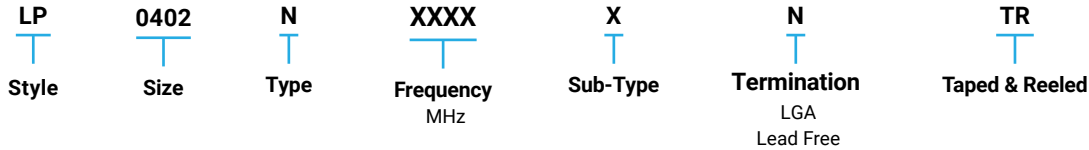

QUALITY INSPECTION

Finished parts are 100% tested for electrical parameters and visual characteristics. Each production lot is evaluated on a sample basis for:

- Static Humidity: 85°C, 85% RH, 160 hours
- Endurance: 125°C, IR, 4 hours

TERMINATION

Nickel/Lead-Free solder coating compatible with automatic soldering technologies: reflow, wave soldering, vapor phase and manual.



Thin-Film RF/Microwave Filters

Low Pass – Harmonic Lead-Free

LP0402N Series – LGA Termination



DIMENSIONS: millimeters (inches) (Bottom View)

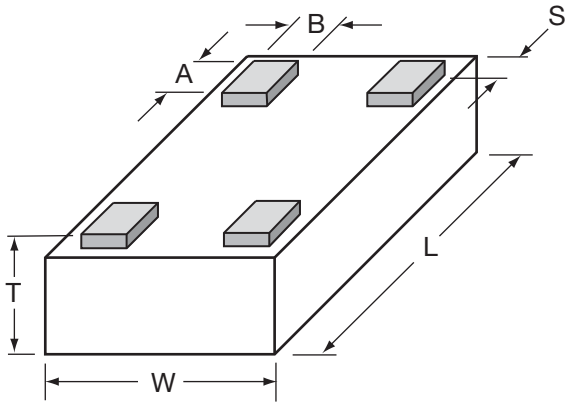

L	1.0±0.05 (0.040±0.002)	A	0.20±0.06 (0.008±0.002)
W	0.58±0.04 (0.023±0.002)	B	0.18±0.05 (0.007±0.002)
T	0.35±0.5 (0.014±0.002)	S	0.05±0.05 (0.002±0.002)

TERMINALS (TOP VIEW)

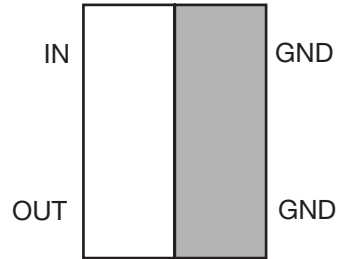

RECOMMENDED PAD LAYOUT (MM)

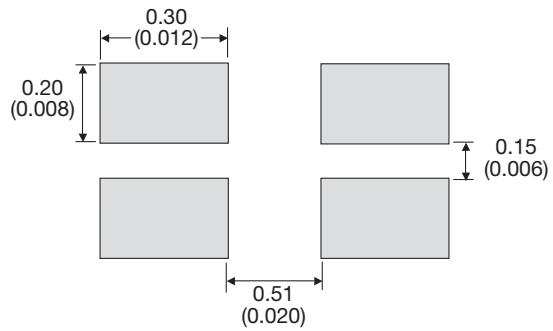

ELECTRICAL CHARACTERISTICS

(Guaranteed over -40°C to $+85^{\circ}\text{C}$ Operating Temperature Range)

P/N	Frequency Band [MHz]	I. Loss [dB]	R. Loss [dB]	Attenuation @ $2x F_0$ [dB]	Attenuation @ $3x F_0$ [dB]
LP0402N2442ANTR	2400-2484	0.35 typ 0.5 max	20	30	17
LP0402N2690ANTR	2640-2740	0.35 typ 0.5 max	20	30	20
LP0402N3500ANTR	3400-3600	0.3 typ 0.5 max	19	30	20
LP0402N5200ANTR	5500-5350	0.2 typ 0.5 max	19	30	20
LP0402N5500ANTR	5350-5650	0.2 typ 0.5 max	15	30	-
LP0402N5800ANTR	5600-6000	0.2 typ 0.5 max	16	25	-

NOTE: Additional Frequencies Available Upon Request



Thin-Film RF/Microwave Filters

Low Pass – Harmonic Lead-Free

LP0402N Series – LGA Termination



LP0402N2442ANTR

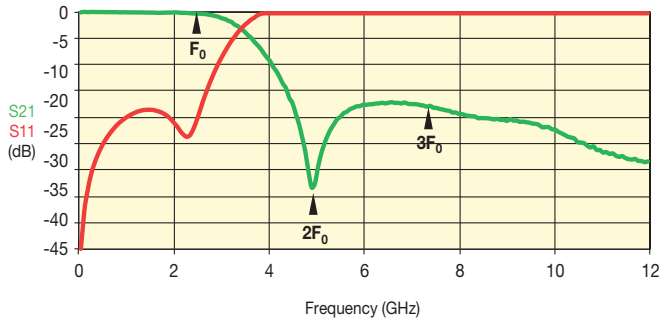

LP0402N5800ANTR

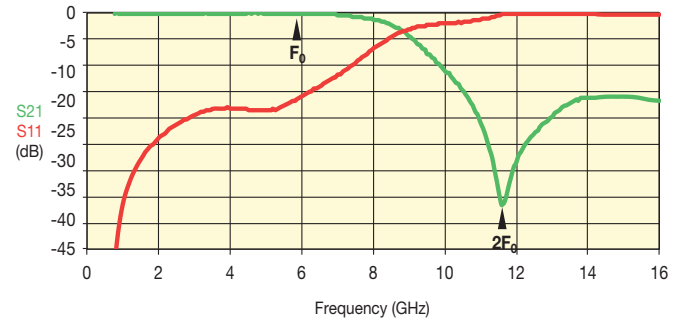

LP0402N2690ANTR

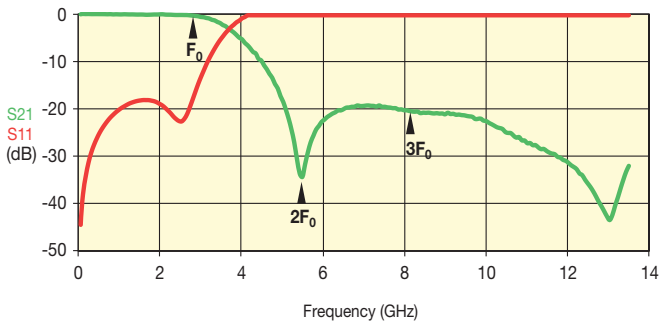

LP0402N3500ANTR

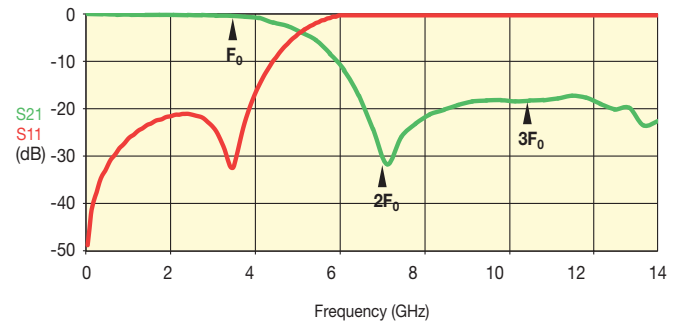

LP0402N5500ANTR

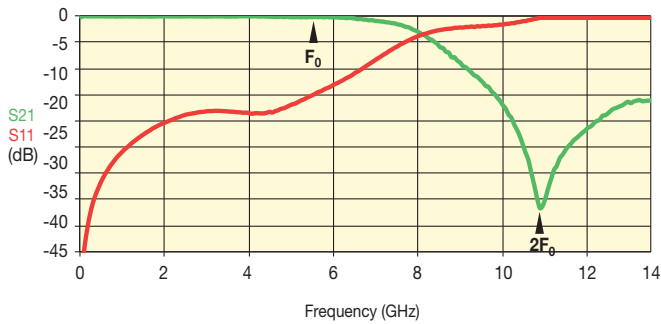

LP0402N5200ANTR

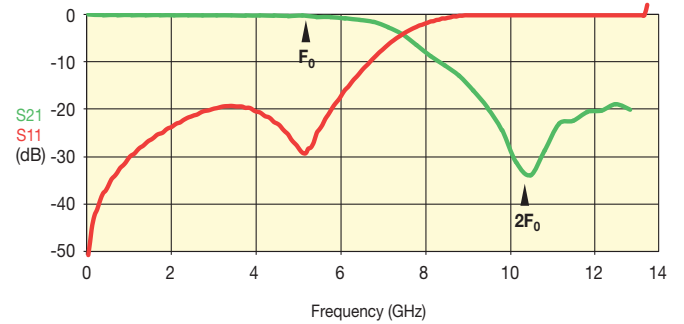

Thin-Film RF/Microwave Filters

Low Pass – Harmonic Lead-Free

LP0402N Series – Test Jig

TEST JIG FOR LP0402 LOW PASS FILTER

GENERAL DESCRIPTION

These jigs are designed for testing the LP0603 LGA Low Pass Filters using a Vector Network Analyzer.

They consist of a dielectric substrate, having 50Ω microstrips as conducting lines and a bottom ground plane located at a distance of 0.127mm from the microstrips.

The substrate used is Neltec's NH9338ST0127C1BC (or similar).

The connectors are SMA type (female), 'Johnson Components Inc.' Product P/N: 142-0701-841 (or similar).

Both a measurement jig and a calibration jig are provided.

The calibration jig is designed for a full 2-port calibration, and consists of an open line, short line and through line. LOAD calibration can be done by a 50Ω SMA termination.

MEASUREMENT PROCEDURE

Follow the VNA's instruction manual and use the [calibration jig](#) to perform a full 2-Port calibration in the required bandwidths.

Solder the filter to the [measurement jig](#) as follows:

Input (Filter)	▶ Connector 1 (Jig)	GND (Filter) ▶ GND (Jig)
Output (Filter)	▶ Connector 2 (Jig)	GND (Filter) ▶ GND (Jig)

Set the VNA to the relevant frequency band. Connect the VNA using a 10dB attenuator on the jig terminal connected to port 2 (using an RF cable).

Measurement

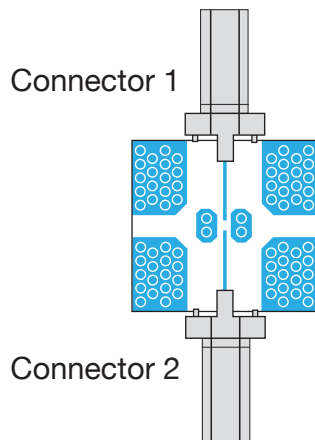

Calibration Jig

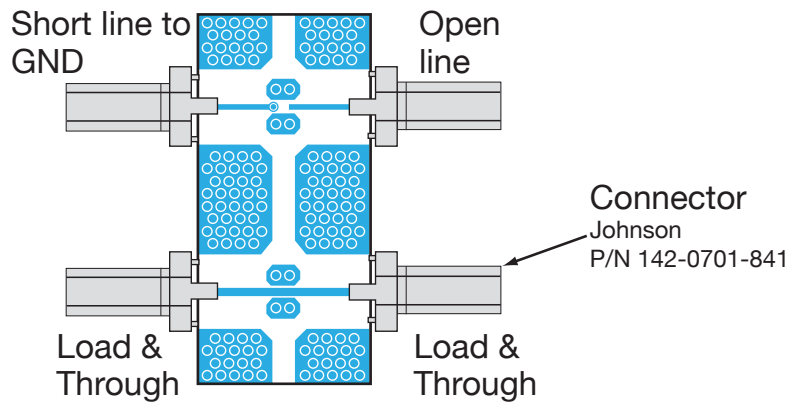

Thin-Film RF/Microwave Filters

Low Pass – Harmonic Lead-Free

LP0603 Series – LGA Termination



GENERAL DESCRIPTION

The LP0603 ITF (Integrated Thin Film) Lead-Free LGA Low Pass Filter is based on thin-film multilayer technology. The technology provides a miniature part with excellent high frequency performance and rugged construction for reliable automatic assembly.

The ITF Low Pass Filters are offered in a variety of frequency bands compatible with various types of high frequency wireless systems.

FEATURES

- Miniature Size: 0603
- Frequency Range: 900MHz-6.0GHz
- Characteristic Impedance: 50 Ohm
- Operating/Storage Temperature: -40°C to +85°C
- Power Rating: 3W Continuous
- Low Profile
- Rugged Construction
- Lead Free
- Taped and Reeled

APPLICATIONS

- Mobile communications
- Satellite TV receivers
- GPS
- Vehicle location systems
- Wireless LANs
- RFID

LAND GRID ARRAY ADVANTAGES

- Inherent Low Profile
- Self Alignment during Reflow
- Excellent Solderability
- Low Parasitics
- Better Heat Dissipation

HOW TO ORDER

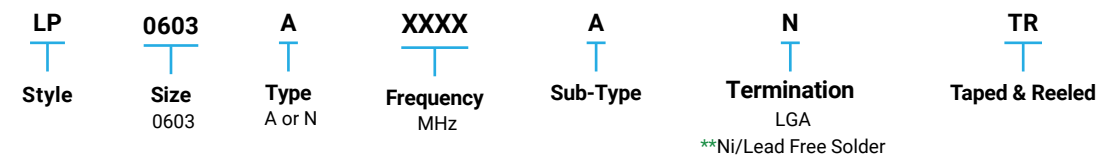

FINAL QUALITY INSPECTION

Finished parts are 100% tested for electrical parameters and visual characteristics. Each production lot is evaluated on a sample basis for:

- Static Humidity: 85°C, 85% RH, 160 hours
- Endurance: 125°C, IR, 4 hours

TERMINATION

Nickel/Lead-Free Solder coating compatible with automatic soldering technologies: reflow, wave soldering, vapor phase and manual.

**RoHS compliant



LEAD-FREE
LEAD-FREE COMPATIBLE
COMPONENT



RoHS
COMPLIANT

Thin-Film RF/Microwave Filters

Low Pass – Lead-Free

LP0603 Series – LGA Termination



DIMENSIONS: millimeters (inches) (Bottom View)

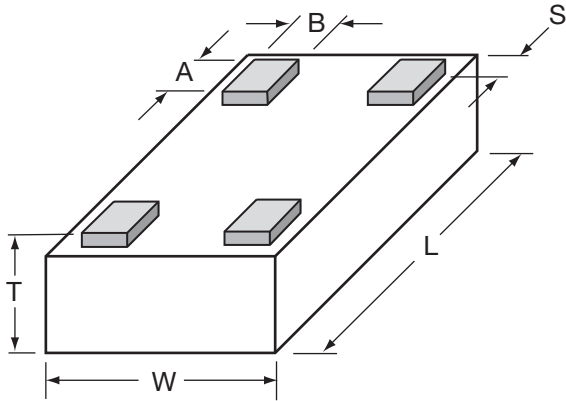

L	1.6±0.1 (0.063±0.004)	A	0.25±0.05 (0.010±0.002)
W	0.84±0.1 (0.033±0.004)	B	0.20±0.05 (0.008±0.002)
T	0.60±0.1 (0.024±0.004)	S	0.05±0.05 (0.002±0.002)

TERMINALS AND ORIENTATION IN TAPE (TOP VIEW)

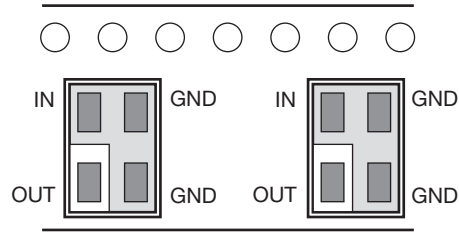

RECOMMENDED PAD LAYOUT (MM)

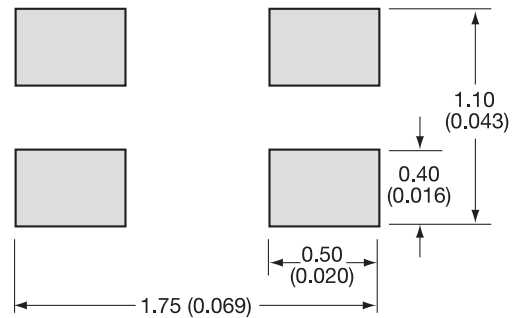

ELECTRICAL CHARACTERISTICS

(Guaranteed over -40°C to $+85^{\circ}\text{C}$ Operating Temperature Range)

P/N	Frequency Band [MHz]	I. Loss [dB]	VSWR max [dB]	Attenuation typ. [dB]
LP0603A0902ANTR	890-915	0.35 typ (0.5 max)	1.4	25 @ 2xF0 14 @ 3xF0
LP0603A0947ANTR	935-960	0.35 typ (0.5 max)	1.4	25 @ 2xF0 17 @ 3xF0
LP0603A1747ANTR	1710-1785	0.3 typ (0.5 max)	1.4	25 @ 2xF0 17 @ 3xF0
LP0603A1842ANTR	1805-1880	0.3 typ (0.5 max)	1.4	27 @ 2xF0 15 @ 3xF0
LP0603A1880ANTR	1840-1920	0.3 typ (0.5 max)	1.4	25 @ 2xF0 17 @ 3xF0
LP0603A1950ANTR	1920-1980	0.3 typ (0.5 max)	1.4	27 @ 2xF0 15 @ 3xF0
LP0603A2140ANTR	2110-2170	0.3 typ (0.5 max)	1.4	27 @ 2xF0 17 @ 3xF0
LP0603A2442ANTR	2412-2472	0.3 typ (0.5 max)	1.4	25 @ 2xF0 17 @ 3xF0
LP0603N3500ANTR	3400-3600	-0.3 typ. -0.5 max.	1.4	30 @ 2xF0 20 @ 3xF0
LP0603N4500ANTR	4400-4600	-0.3 typ. -0.5 max.	1.4	30 @ 2xF0 20 @ 3xF0
LP0603N5200ANTR	5050-5350	-0.2 typ. -0.5 max.	1.4	30 @ 2xF0 20 @ 3xF0
LP0603N5500ANTR	5350-5650	-0.2 typ. -0.5 max.	1.4	30 @ 2xF0 20 @ 3xF0
LP0603N6000ANTR	5900-6100	-0.3 typ. -0.5 max.	1.4	30 @ 2xF0 20 @ 3xF0

NOTE: Additional Frequencies Available Upon Request

Thin-Film RF/Microwave Filters

Low Pass – Lead-Free

LP0603 Series – LGA Termination



LP0603A0902ANTR

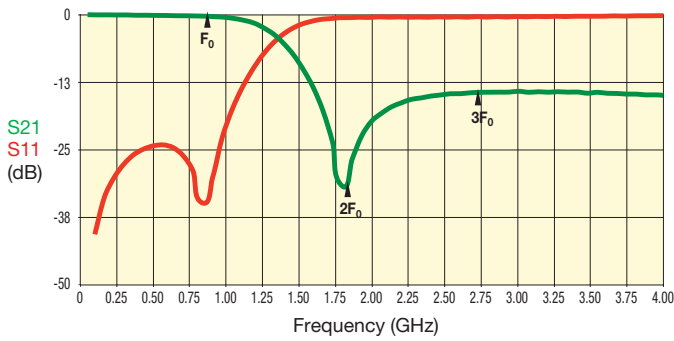

LP0603A0947ANTR

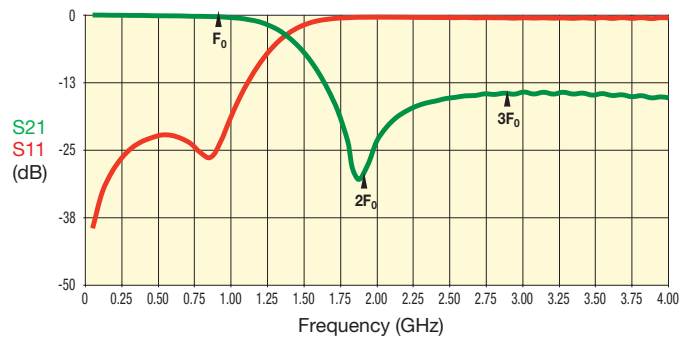

LP0603A1747ANTR

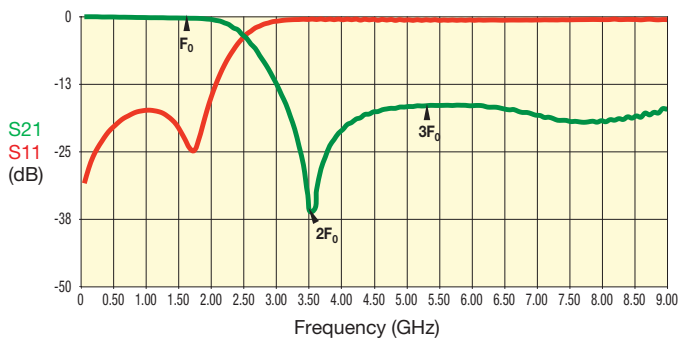

LP0603A1842ANTR

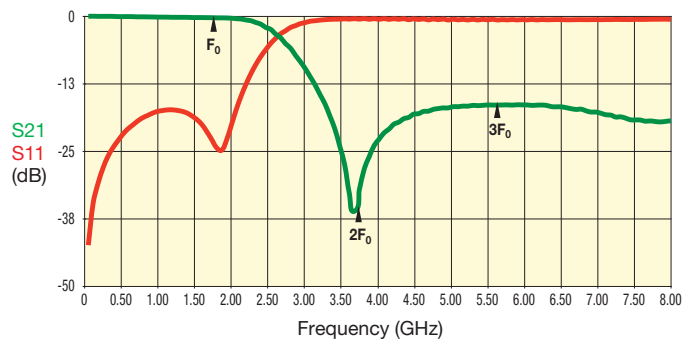

LP0603A1880ANTR

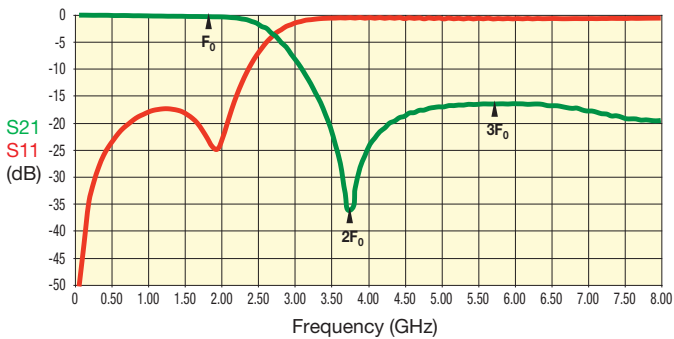

LP0603A1950ANTR

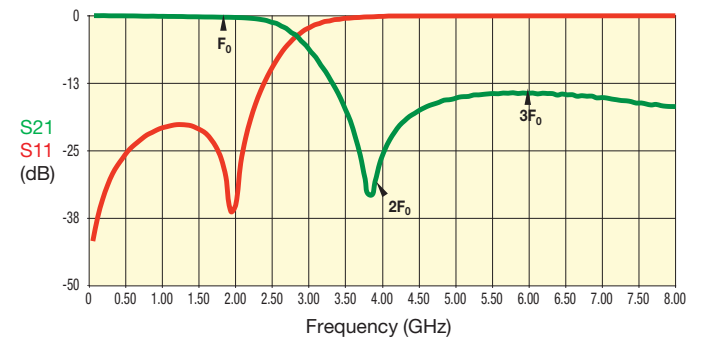

Thin-Film RF/Microwave Filters

Low Pass – Lead-Free

LP0603 Series – LGA Termination



LP0603A2140ANTR

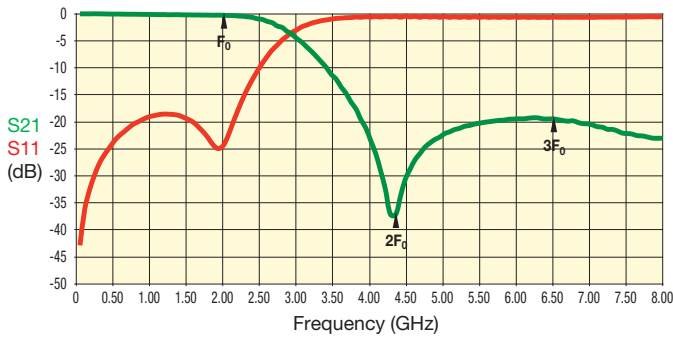

LP0603A2442ANTR

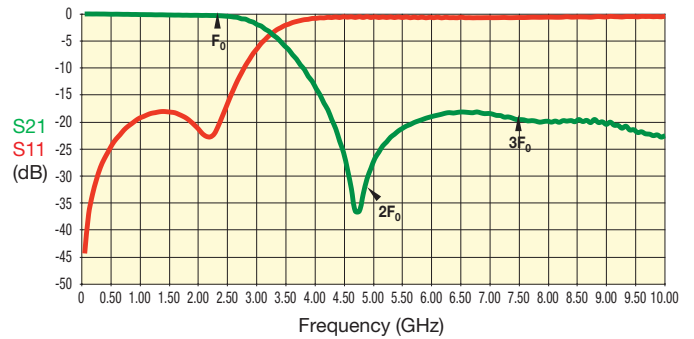

LP0603N3500ANTR

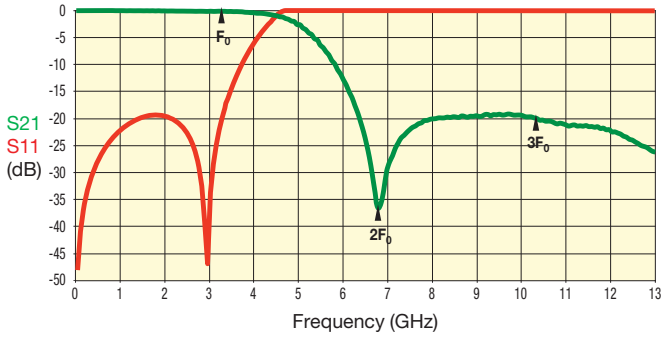

LP0603N5200ANTR

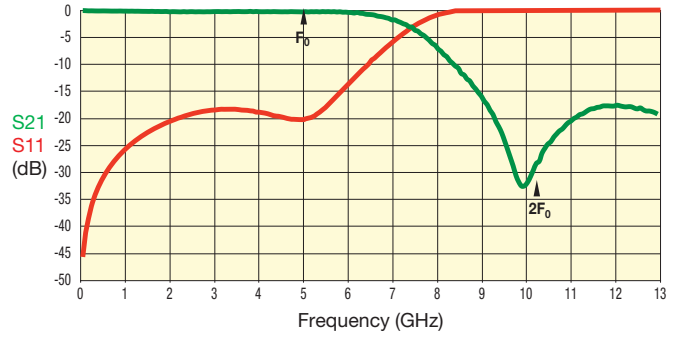

LP0603N5500ANTR

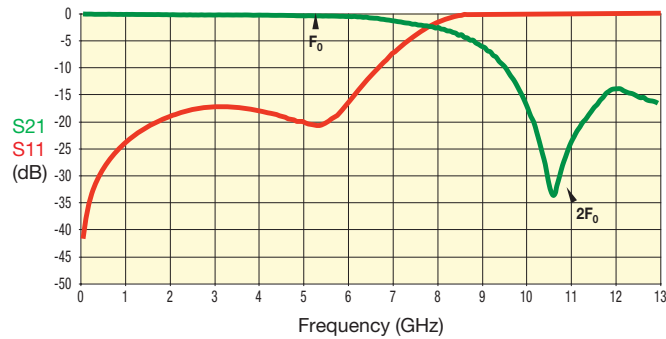

LP0603N4500ANTR

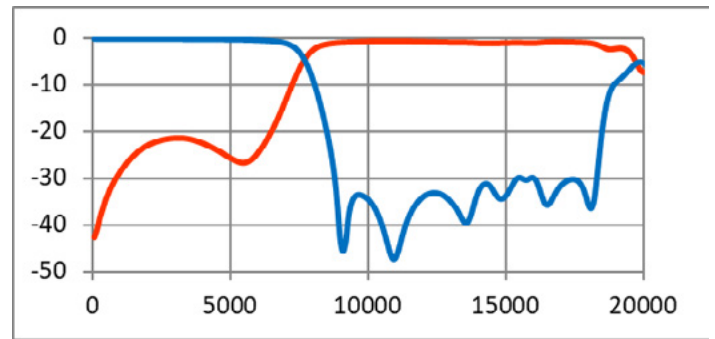

LP0603N6000ANTR

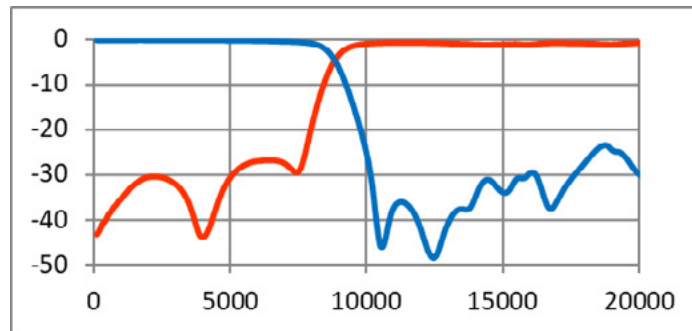

Thin-Film RF/Microwave Filters

Low Pass – Lead-Free

LP0603 Series – Test Jig

TEST JIG FOR LP0603 LEAD-FREE LGA LOW PASS FILTER

GENERAL DESCRIPTION

These jigs are designed for testing the LP0603 LGA Low Pass Filters using a Vector Network Analyzer.

They consist of a dielectric substrate, having 50Ω microstrips as conducting lines and a bottom ground plane located at a distance of 0.127mm from the microstrips.

The substrate used is Neltec's NH9338ST0127C1BC (or similar).

The connectors are SMA type (female), 'Johnson Components Inc.' Product P/N: 142-0701-841 (or similar).

Both a measurement jig and a calibration jig are provided.

The calibration jig is designed for a full 2-port calibration, and consists of an open line, short line and through line. LOAD calibration can be done by a 50Ω SMA termination.

MEASUREMENT PROCEDURE

Follow the VNA's instruction manual and use the [calibration jig](#) to perform a full 2-Port calibration in the required bandwidths.

Solder the filter to the [measurement jig](#) as follows:

Input (Filter)	▶ Connector 1 (Jig)	GND (Filter) ▶ GND (Jig)
Output (Filter)	▶ Connector 2 (Jig)	GND (Filter) ▶ GND (Jig)

Set the VNA to the relevant frequency band. Connect the VNA using a 10dB attenuator on the jig terminal connected to port 2 (using an RF cable).

Measurement

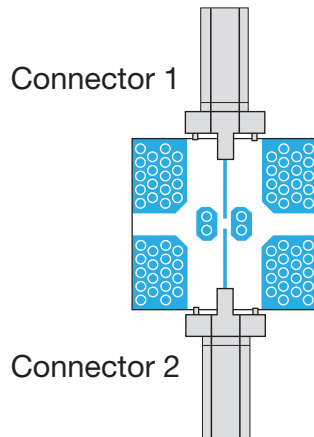

Calibration Jig

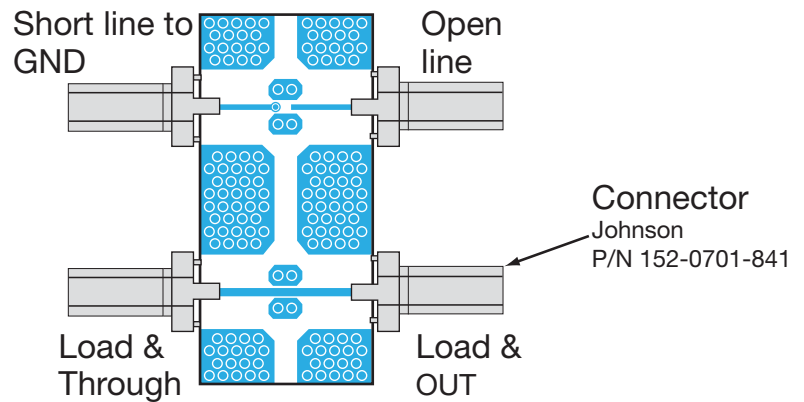

Thin-Film RF/Microwave Filters

Low Pass – Harmonic

LP0805 Series – SMD Termination

GENERAL DESCRIPTION

The ITF (Integrated Thin-Film) SMD Filter is based on thin-film multilayer technology. The technology provides a miniature part with excellent high frequency performance and rugged construction for reliable automatic assembly.

The ITF Filter is offered in a variety of frequency bands compatible with various types of high frequency wireless systems.

FEATURES

- Small Size: 0805
- Frequency Range: 800MHz - 3.5GHz
- Characteristic Impedance: 50Ω
- Operating / Storage Temp.: -40°C to +85°C
- Power Rating: 3W Continuous
- Low Profile
- Rugged Construction
- Taped and Reeled

APPLICATIONS

- Mobile Communications
- Satellite TV Receivers
- GPS
- Vehicle Location Systems
- Wireless LAN's

DIMENSIONS: millimeters (inches)

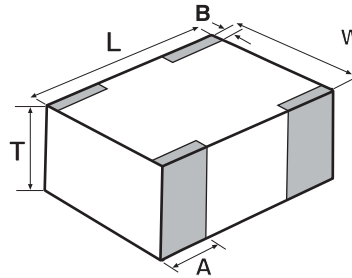

L	2.03±0.1 (0.080±0.004)
W	1.55±0.1 (0.061±0.004)
T	1.02±0.1 (0.040±0.004)
A	0.56±0.25 (0.022±0.010)
B	0.35±0.15 (0.014±0.006)

PAD LAYOUT

See CP0805 pad layout on page 64.

FINAL QUALITY INSPECTION

Finished parts are 100% tested for electrical parameters and visual/mechanical characteristics. Each production lot is evaluated on a sample basis for:

- Static Humidity: 85°C, 85% RH, 160 hours
- Endurance: 125°C, I_R 4 hours

TERMINATION

Nickel/Solder coating (Sn, Pb) compatible with automatic soldering technologies: reflow, wave soldering, vapor phase and manual.

HOW TO ORDER

LP
Style
Low Pass

0805A
Size
0805

0902
Frequency
MHz

AW
Termination
AW = Nickel/Solder (SnPb)
**AS = Nickel/ Lead Free
Solder (Sn100)

TR
Taped & Reeled
TR = Tape and Reel

**RoHS compliant

Not RoHS Compliant



For RoHS compliant products,
please select correct termination style.

TERMINALS AND LAYOUT (TOP VIEW)

ORIENTATION IN TAPE

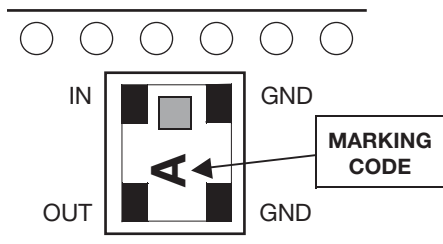

ELECTRICAL CHARACTERISTICS

Application	Part Number	Frequency Band (MHz)	I. Loss max	VSWR max	Attenuation (dB) Typical	Layout Type (SnPb)	Layout Type F Marking Code
E-G SM	LP0805A0897AS	880 - 915	0.4dB (0.3dB typ)	1.7	30 @ 2X F_o 20 @ 3x F_o	A	E
	LP0805A0942AS	925 - 960				A	F
GSM	LP0805A0902AS	890 - 915				A	E
	LP0805A0947AS	935 - 960				A	F
	LP0805A1119AS	1101 - 1137				A	H
AM PS	LP0805A0836AS	824 - 849				A	A
	LP0805A0881AS	869 - 894				A	C
PCN	LP0805A1747AS	1710 - 1785				D	I
	LP0805A1842AS	1805 - 1880				D	J
PCS	LP0805A1880AS	1850 - 1910				D	K
	LP0805A1960AS	1930 - 1990				D	M
PHP	LP0805A1907AS	1895 - 1920				D	L
DECT	LP0805A1890AS	1880 - 1900				D	K
3G	LP0805A2150AS	1905 - 2180				D	N
Wireless LAN	LP0805A2442AS	2400 - 2484				D	S
WLL	LP0805A3500AS	3400 ~ 3600				E	X

Typical Electrical Performance

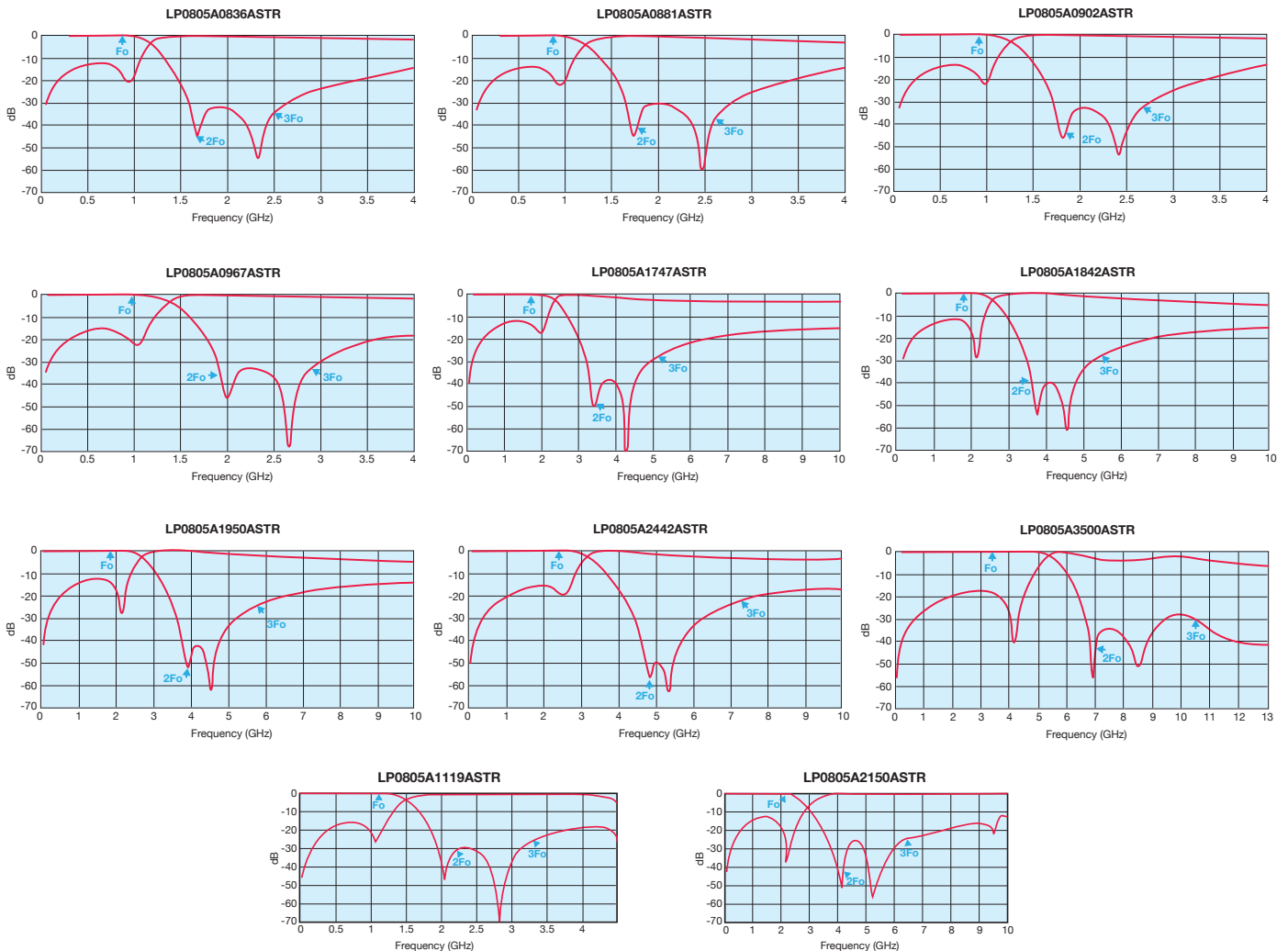

Thin-Film RF/Microwave Filters

Low Pass – Harmonic

LP0805 Series – Test Jig

ITF TEST JIG FOR LOW PASS FILTER 0805

GENERAL DESCRIPTION

These jigs are designed for testing the LPF0805 Low Pass Filters using a Vector Network Analyzer.

They consist of a dielectric substrate, having 50W microstrips as conducting lines and a bottom ground plane located at a distance of 0.254 mm from the microstrips.

The substrate used is RF-35-0100-C1B107 (or similar).

The connectors are SMA type (female), 'Johnson Components Inc.' Product P/N: 142-0701-841 (or similar).

Both a measurement jig and a calibration jig are provided.

The calibration jig is designed for a full 2-port calibration, and consists of an open line, short line and through line. LOAD calibration can be done by a 50W SMA termination.

MEASUREMENT PROCEDURE

Follow the VNA's instruction manual and use the [calibration jig](#) to perform a full 2-Port calibration in the required bandwidths.

Solder the filter to the [measurement jig](#) as follows:

Input (Filter)	↗ Connector 1 (Jig)	GND (Filter) ↘ GND (Jig)
Output (Filter)	↗ Connector 2 (Jig)	GND (Filter) ↘ GND (Jig)

Set the VNA to the relevant frequency band. Connect the VNA using a 10dB attenuator on the jig terminal connected to port 2 (using an RF cable).

Measurement

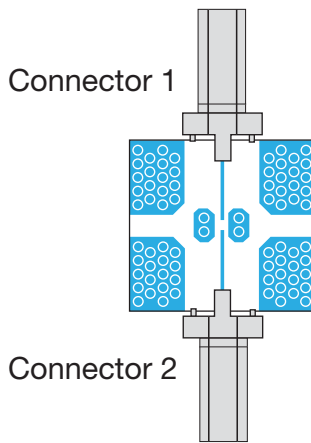

Calibration Jig

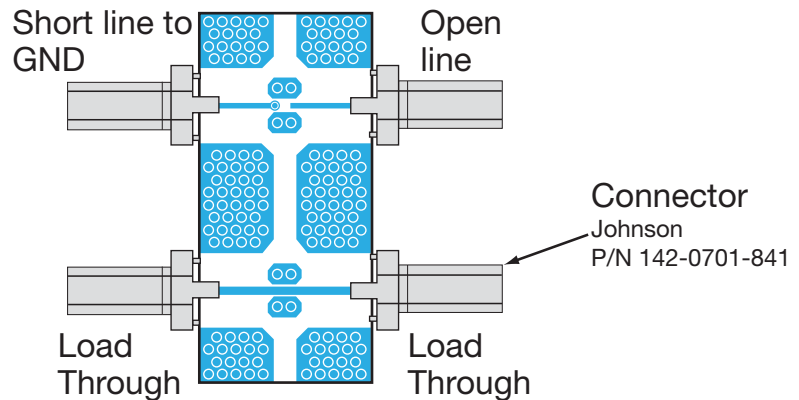



High Performance Low Pass Filters

0805 High Performance Low Pass 8W

Thin-Film RF/Microwave Filters

Low Pass 0805 High Performance SMD 8W

LP0805H0400ASTR – SMD Termination



ITF TECHNOLOGY

The ITF SMD Filter is based on thin-film multilayer technology. The technology provides a miniature part with excellent high frequency performance and rugged construction for reliable automatic assembly.

The ITF Filter is offered in a variety of frequency bands compatible with various types of high frequency wireless systems.

FEATURES

- Small size: 0805
- Frequency: 400MHz
- Sharp attenuation slope
- Characteristic impedance: 50ohm
- Operating / Storage temp: -40°C – +100°C
- Low profile
- Rugged construction
- Taped and reeled
- Power handling: 8W

APPLICATIONS

- Mobile communications
- Satellite TV receivers
- GPS
- Vehicle location systems
- Wireless LAN's

HOW TO ORDER

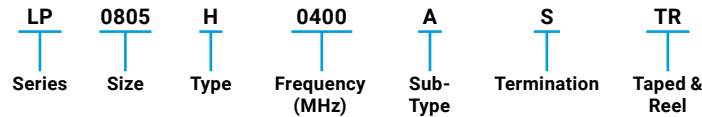

FINAL QUALITY INSPECTION

Finished parts are 100% tested for electrical parameters and visual/mechanical characteristics. Each production lot is evaluated on a sample basis for:

- Static Humidity: 85°C, 85% RH, 160 hours
- Endurance: 125°C, I_R, 4 hours

TERMINATION

Nickel/ Lead free Solder coating (Sn100) compatible with automatic soldering technologies: reflow, wave soldering, vapor phase and manual.

DIMENSIONS (TOP VIEW)

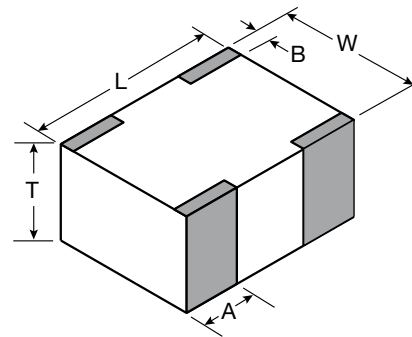

mm (inches)	
L	2.03±0.10 (0.080±0.004)
W	1.55±0.10 (0.061±0.004)
T	0.80±0.10 (0.031±0.004)
A	0.56±0.25 (0.022±0.010)
B	0.35±0.15 (0.014±0.006)

TERMINALS AND LAYOUT (TOP VIEW)

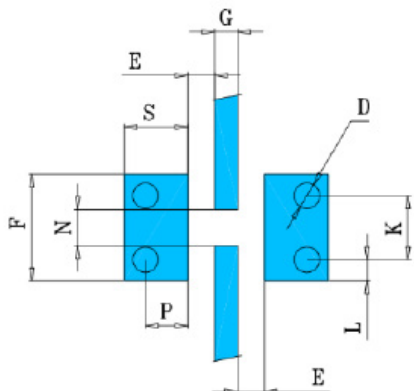
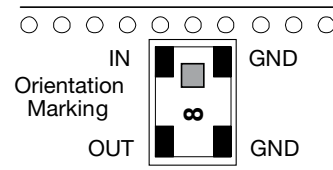

Dimensions: millimeters

G	0.54
N	0.85
E	0.63
S	1.5
F	2.5
K	1.5
P	1.0
L	0.5
D	∅0.6

Thin-Film RF/Microwave Filters

Low Pass 0805 High Performance SMD 8W

LP0805H0400ASTR – SMD Termination



ELECTRICAL CHARACTERISTICS

P/N	Frequency	I.Loss @ 400MHz	R.Loss @ 400MHz	Attenuation
LP0805H0400ASTR	400MHz	-0.6dB max.	-15dB	-30dB at 800MHz -20dB at 1200MHz

TYPICAL ELECTRICAL PERFORMANCE

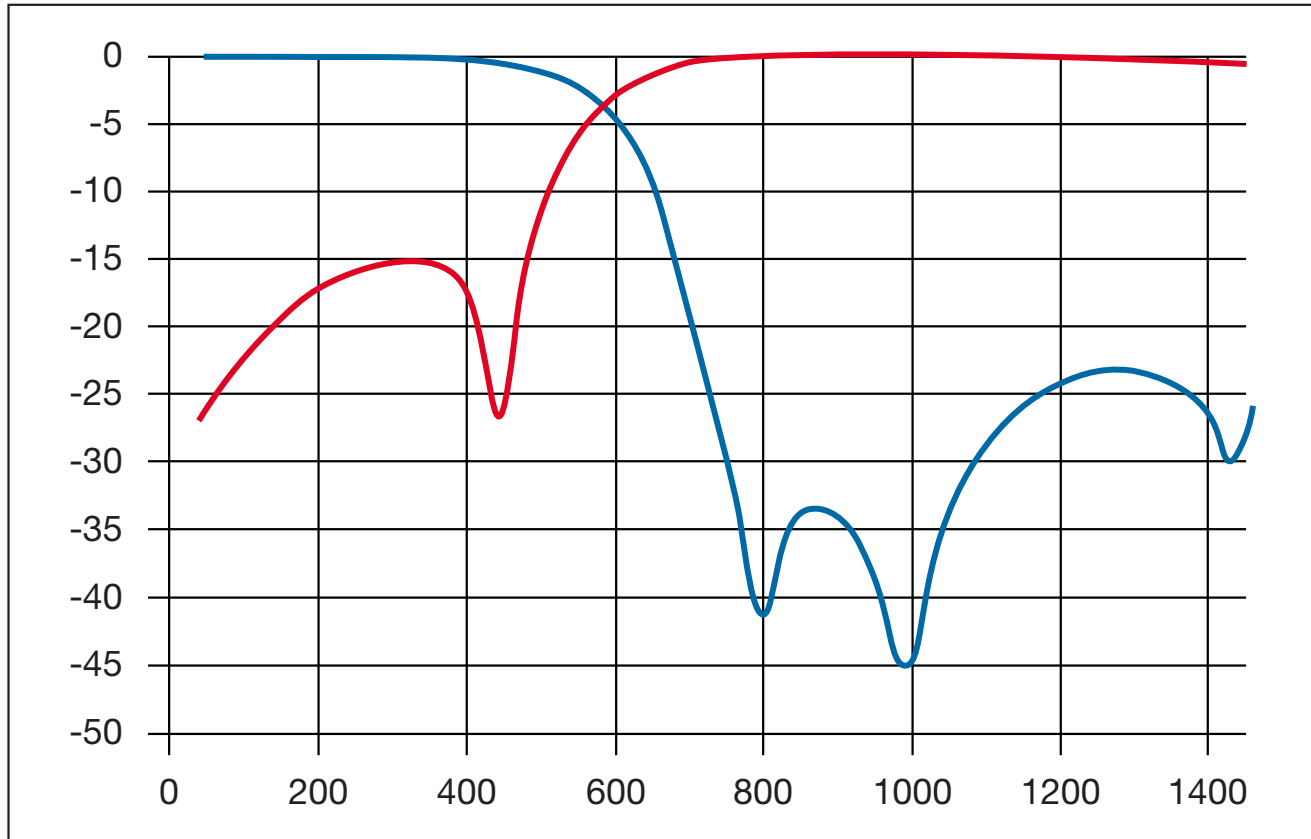

Thin-Film RF/Microwave Filters

Low Pass 0805 High Performance SMD 8W

LP0805H0420ASTR – SMD Termination

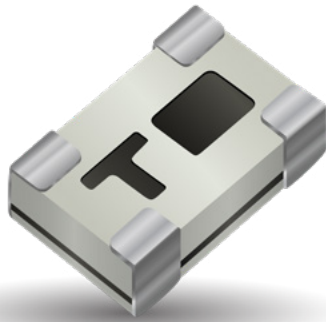

ITF TECHNOLOGY

The ITF SMD Filter is based on thin-film multilayer technology. The technology provides a miniature part with excellent high frequency performance and rugged construction for reliable automatic assembly.

The ITF Filter is offered in a variety of frequency bands compatible with various types of high frequency wireless systems.

FEATURES

- Small size: 0805
- Frequency: 420MHz
- Sharp attenuation slope
- Characteristic impedance: 50ohm
- Operating / Storage temp: -40°C – +100°C
- Low profile
- Rugged construction
- Taped and reeled
- Power handling: 8W

APPLICATIONS

- Mobile communications
- Satellite TV receivers
- GPS
- Vehicle location systems
- Wireless LAN's

HOW TO ORDER

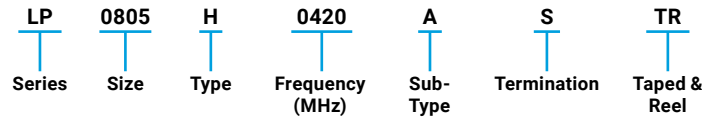

FINAL QUALITY INSPECTION

Finished parts are 100% tested for electrical parameters and visual/mechanical characteristics. Each production lot is evaluated on a sample basis for:

- Static Humidity: 85°C, 85% RH, 160 hours
- Endurance: 125°C, I_R, 4 hours

TERMINATION

Nickel/ Lead free Solder coating (Sn100) compatible with automatic soldering technologies: reflow, wave soldering, vapor phase and manual.

DIMENSIONS (TOP VIEW)

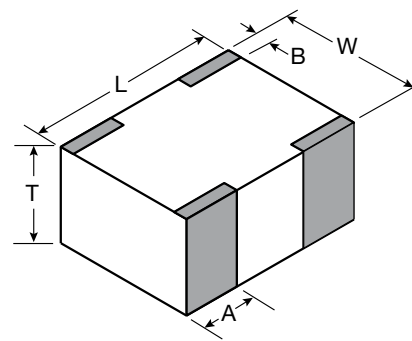

mm (inches)	
L	2.03±0.10 (0.080±0.004)
W	1.55±0.10 (0.061±0.004)
T	0.80±0.10 (0.031±0.004)
A	0.56±0.25 (0.022±0.010)
B	0.35±0.15 (0.014±0.006)

TERMINALS AND LAYOUT (TOP VIEW)

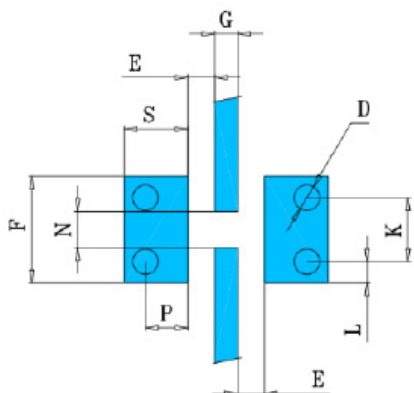
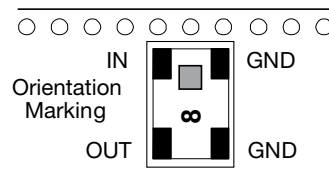

Dimensions: millimeters

G	0.54
N	0.85
E	0.63
S	1.5
F	2.5
K	1.5
P	1.0
L	0.5
D	∅0.6

Thin-Film RF/Microwave Filters

Low Pass 0805 High Performance SMD 8W

LP0805H0420ASTR – SMD Termination



ELECTRICAL CHARACTERISTICS

P/N	Frequency	I.Loss @ 700MHz	R.Loss @ 700MHz	Attenuation
LP0805H0420ASTR	420MHz	-0.6dB max.	-15dB	-30dB at 840MHz -20dB at 1260MHz

TYPICAL ELECTRICAL PERFORMANCE

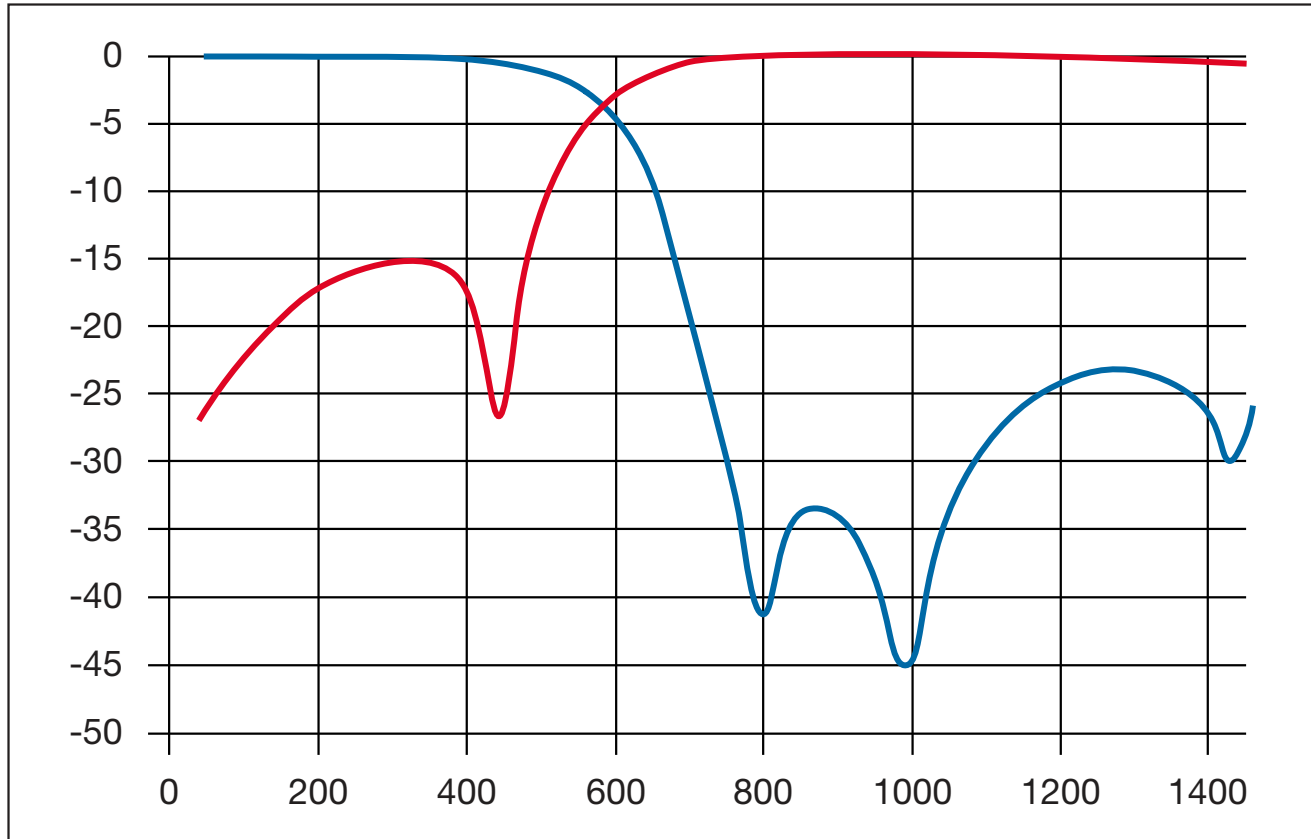

Thin-Film RF/Microwave Filters

Low Pass 0805 High Performance SMD 8W

LP0805H0450ASTR – SMD Termination



ITF TECHNOLOGY

The ITF SMD Filter is based on thin-film multilayer technology. The technology provides a miniature part with excellent high frequency performance and rugged construction for reliable automatic assembly.

The ITF Filter is offered in a variety of frequency bands compatible with various types of high frequency wireless systems.

FEATURES

- Small size: 0805
- Frequency: 450MHz
- Sharp attenuation slope
- Characteristic impedance: 50ohm
- Operating / Storage temp: -40°C – +100°C
- Low profile
- Rugged construction
- Taped and reeled
- Power handling: 8W

APPLICATIONS

- Mobile communications
- Satellite TV receivers
- GPS
- Vehicle location systems
- Wireless LAN's

HOW TO ORDER

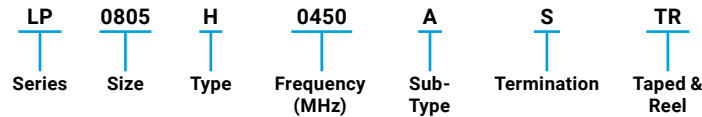

FINAL QUALITY INSPECTION

Finished parts are 100% tested for electrical parameters and visual/mechanical characteristics. Each production lot is evaluated on a sample basis for:

- Static Humidity: 85°C, 85% RH, 160 hours
- Endurance: 125°C, I_R, 4 hours

TERMINATION

Nickel/ Lead free Solder coating (Sn100) compatible with automatic soldering technologies: reflow, wave soldering, vapor phase and manual.

DIMENSIONS (TOP VIEW)

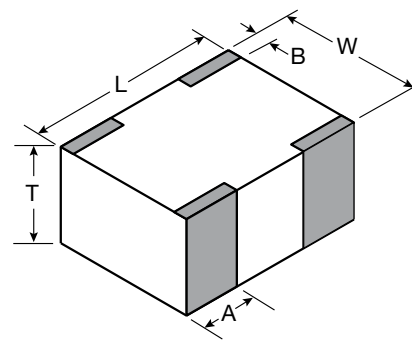

mm (inches)

L	2.03±0.10 (0.080±0.004)
W	1.55±0.10 (0.061±0.004)
T	0.80±0.10 (0.031±0.004)
A	0.56±0.25 (0.022±0.010)
B	0.35±0.15 (0.014±0.006)

TERMINALS AND LAYOUT (TOP VIEW)

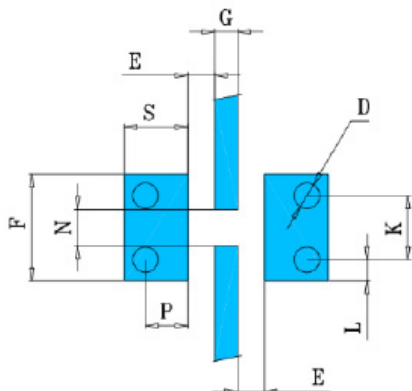
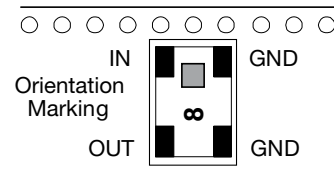

Dimensions: millimeters

G	0.54
N	0.85
E	0.63
S	1.5
F	2.5
K	1.5
P	1.0
L	0.5
D	∅0.6

Thin-Film RF/Microwave Filters

Low Pass 0805 High Performance SMD 8W

LP0805H0450ASTR – SMD Termination



ELECTRICAL CHARACTERISTICS

P/N	Frequency	I.Loss @ 700MHz	R.Loss @ 700MHz	Attenuation
LP0805H0450ASTR	450MHz	-0.6dB max.	-15dB	-28dB at 900MHz -20dB at 1350MHz

TYPICAL ELECTRICAL PERFORMANCE

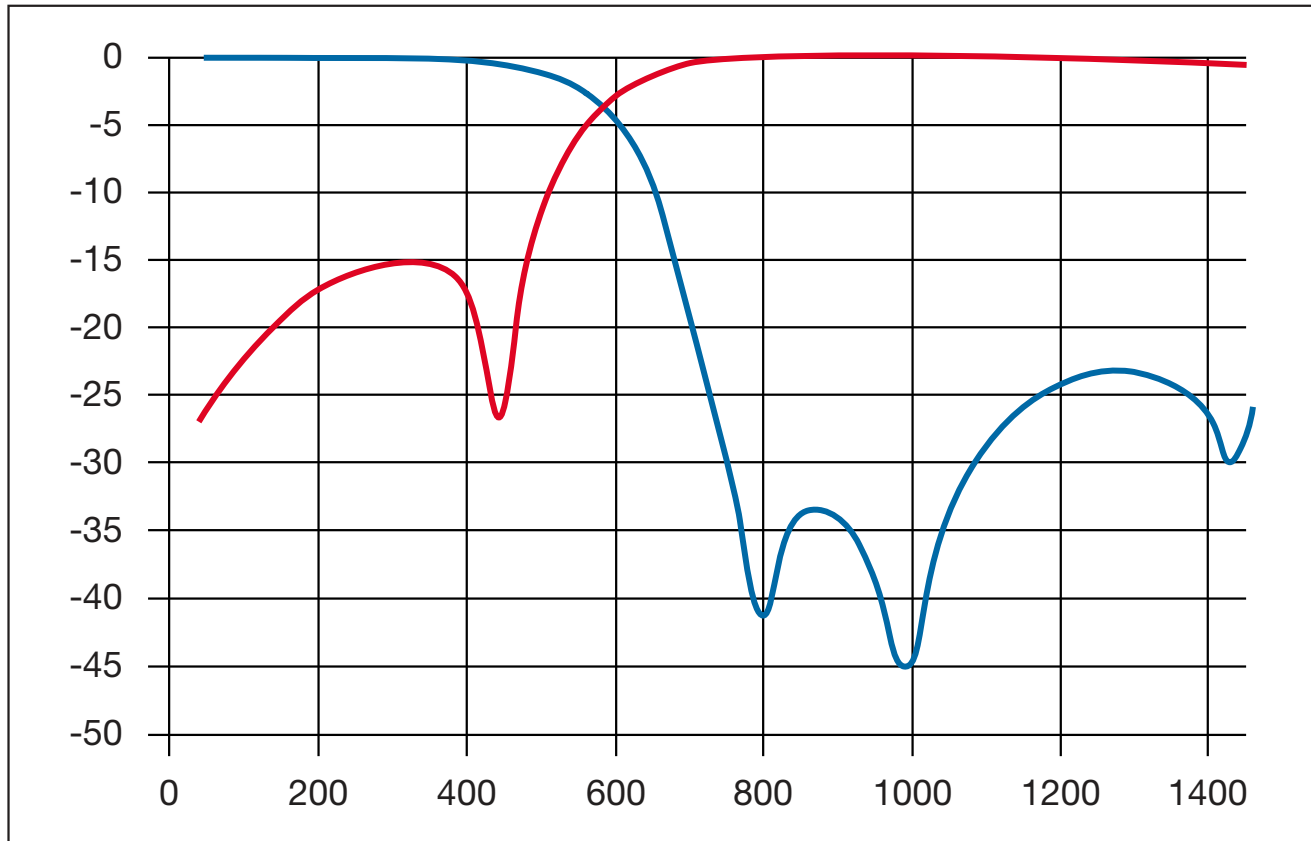

Thin-Film RF/Microwave Filters

Low Pass 0805 High Performance SMD 8W

LP0805H0470ASTR – SMD Termination



ITF TECHNOLOGY

The ITF SMD Filter is based on thin-film multilayer technology. The technology provides a miniature part with excellent high frequency performance and rugged construction for reliable automatic assembly.

The ITF Filter is offered in a variety of frequency bands compatible with various types of high frequency wireless systems.

FEATURES

- Small size: 0805
- Frequency: 470MHz
- Sharp attenuation slope
- Characteristic impedance: 50ohm
- Operating / Storage temp: -40°C – +100°C
- Low profile
- Rugged construction
- Taped and reeled
- Power handling: 8W

APPLICATIONS

- Mobile communications
- Satellite TV receivers
- GPS
- Vehicle location systems
- Wireless LAN's

HOW TO ORDER

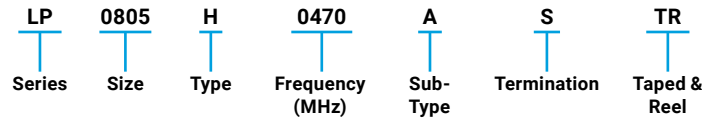

FINAL QUALITY INSPECTION

Finished parts are 100% tested for electrical parameters and visual/mechanical characteristics. Each production lot is evaluated on a sample basis for:

- Static Humidity: 85°C, 85% RH, 160 hours
- Endurance: 125°C, I_R, 4 hours

TERMINATION

Nickel/ Lead free Solder coating (Sn100) compatible with automatic soldering technologies: reflow, wave soldering, vapor phase and manual.

DIMENSIONS (TOP VIEW)

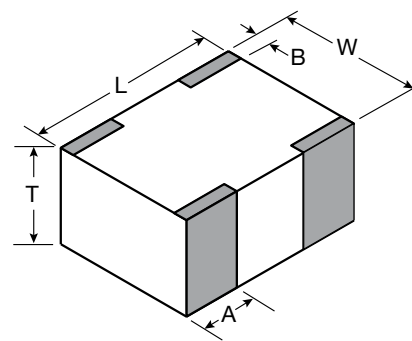

mm (inches)

L	2.03±0.10 (0.080±0.004)
W	1.55±0.10 (0.061±0.004)
T	0.80±0.10 (0.031±0.004)
A	0.56±0.25 (0.022±0.010)
B	0.35±0.15 (0.014±0.006)

TERMINALS AND LAYOUT (TOP VIEW)

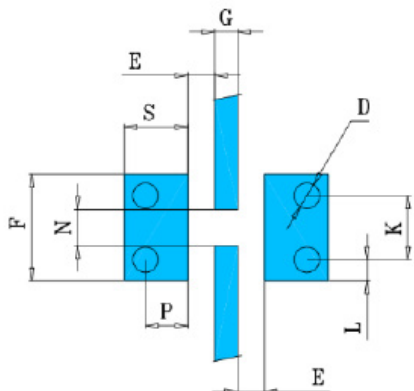
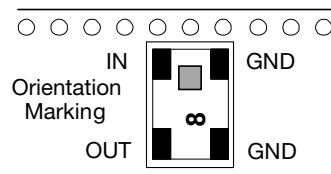

Dimensions: millimeters

G	0.54
N	0.85
E	0.63
S	1.5
F	2.5
K	1.5
P	1.0
L	0.5
D	∅0.6

Thin-Film RF/Microwave Filters

Low Pass 0805 High Performance SMD 8W

LP0805H0470ASTR – SMD Termination



ELECTRICAL CHARACTERISTICS

P/N	Frequency	I.Loss @ 700MHz	R.Loss @ 700MHz	Attenuation
LP0805H0470ASTR	470MHz	-0.7dB max.	-15dB	-28dB at 940MHz -20dB at 1410MHz

TYPICAL ELECTRICAL PERFORMANCE

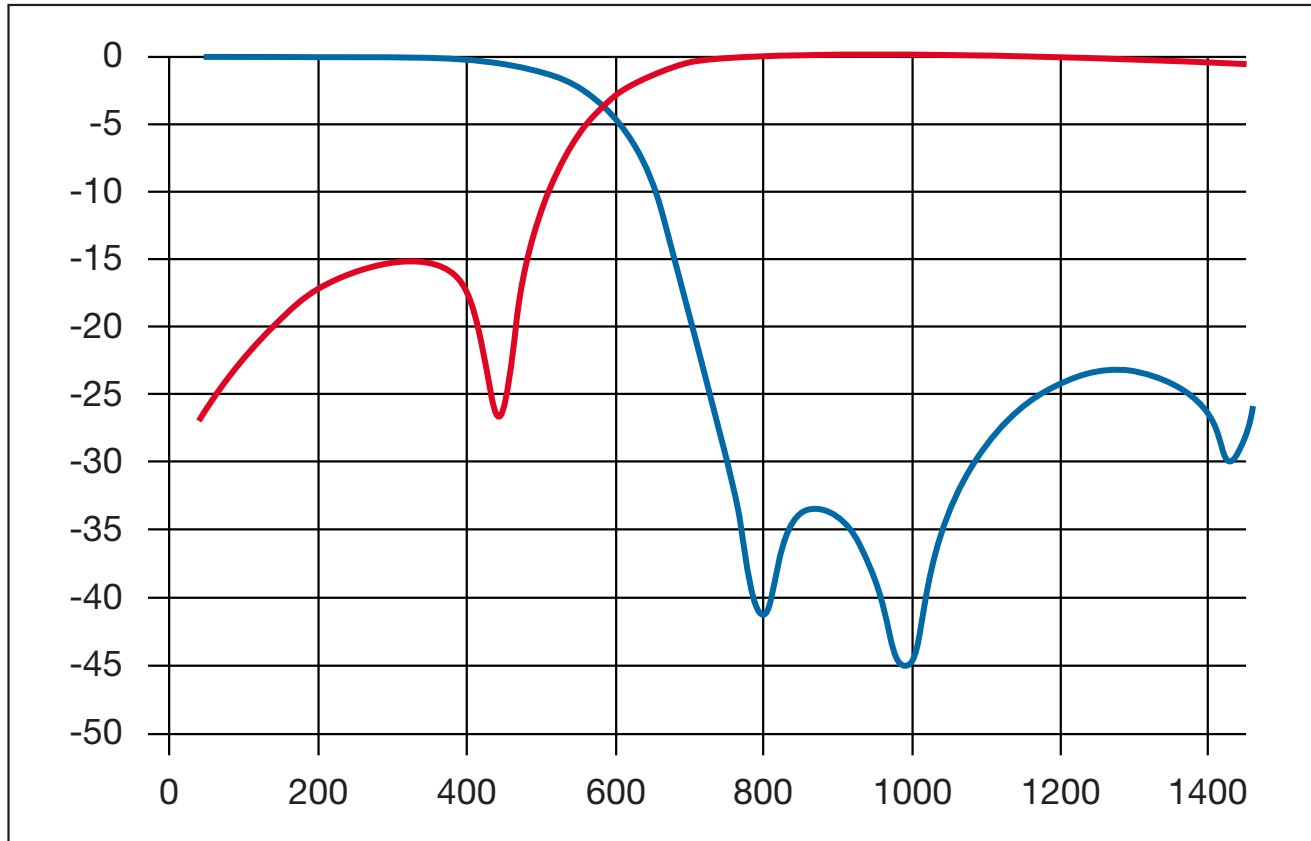

Thin-Film RF/Microwave Filters

Low Pass 0805 High Performance SMD 8W

LP0805H0512ASTR – SMD Termination



ITF TECHNOLOGY

The ITF SMD Filter is based on thin-film multilayer technology. The technology provides a miniature part with excellent high frequency performance and rugged construction for reliable automatic assembly.

The ITF Filter is offered in a variety of frequency bands compatible with various types of high frequency wireless systems.

FEATURES

- Small size: 0805
- Frequency: 512MHz
- Sharp attenuation slope
- Characteristic impedance: 50ohm
- Operating / Storage temp: -40°C – +100°C
- Low profile
- Rugged construction
- Taped and reeled
- Power handling: 8W

APPLICATIONS

- Mobile communications
- Satellite TV receivers
- GPS
- Vehicle location systems
- Wireless LAN's

HOW TO ORDER

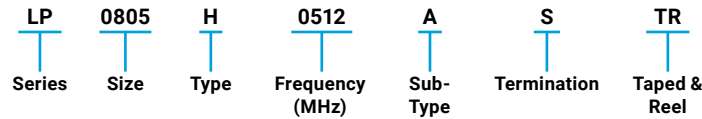

FINAL QUALITY INSPECTION

Finished parts are 100% tested for electrical parameters and visual/mechanical characteristics. Each production lot is evaluated on a sample basis for:

- Static Humidity: 85°C, 85% RH, 160 hours
- Endurance: 125°C, I_R, 4 hours

TERMINATION

Nickel/ Lead free Solder coating (Sn100) compatible with automatic soldering technologies: reflow, wave soldering, vapor phase and manual.

DIMENSIONS (TOP VIEW)

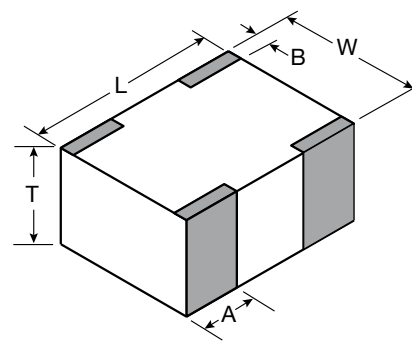

mm (inches)	
L	2.03±0.10 (0.080±0.004)
W	1.55±0.10 (0.061±0.004)
T	0.80±0.10 (0.031±0.004)
A	0.56±0.25 (0.022±0.010)
B	0.35±0.15 (0.014±0.006)

TERMINALS AND LAYOUT (TOP VIEW)

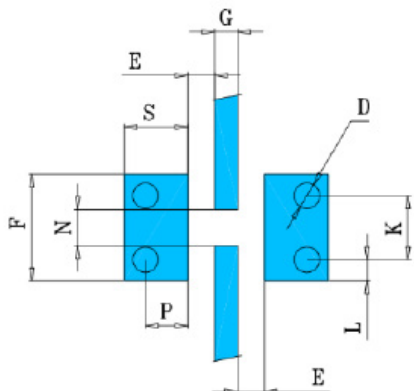
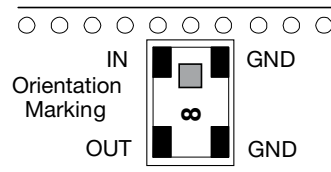

Dimensions: millimeters

G	0.54
N	0.85
E	0.63
S	1.5
F	2.5
K	1.5
P	1.0
L	0.5
D	∅0.6

Thin-Film RF/Microwave Filters

Low Pass 0805 High Performance SMD 8W

LP0805H0512ASTR – SMD Termination



ELECTRICAL CHARACTERISTICS

P/N	Frequency	I.Loss @ 700MHz	R.Loss @ 700MHz	Attenuation
LP0805H0512ASTR	512MHz	-0.75dB max.	-12dB	-35dB at 1024MHz -40dB at 1536MHz

TYPICAL ELECTRICAL PERFORMANCE

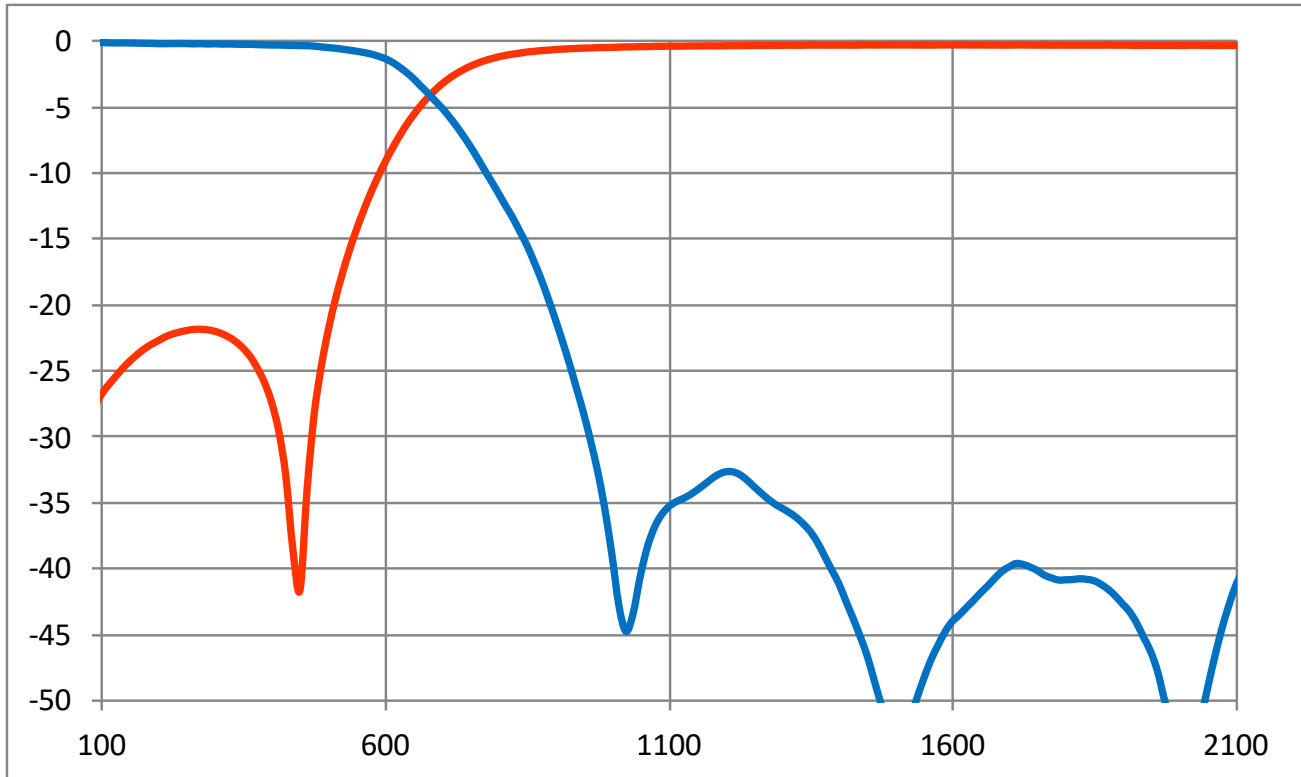

Thin-Film RF/Microwave Filters

Low Pass 0805 High Performance SMD 8W

LP0805H0700ASTR – SMD Termination



ITF TECHNOLOGY

The ITF SMD Filter is based on thin-film multilayer technology. The technology provides a miniature part with excellent high frequency performance and rugged construction for reliable automatic assembly.

The ITF Filter is offered in a variety of frequency bands compatible with various types of high frequency wireless systems.

FEATURES

- Small size: 0805
- Frequency: 700MHz
- Sharp attenuation slope
- Characteristic impedance: 50ohm
- Operating / Storage temp: -40°C – +100°C
- Low profile
- Rugged construction
- Taped and reeled
- Power handling: 8W

APPLICATIONS

- Mobile communications
- Satellite TV receivers
- GPS
- Vehicle location systems
- Wireless LAN's

HOW TO ORDER

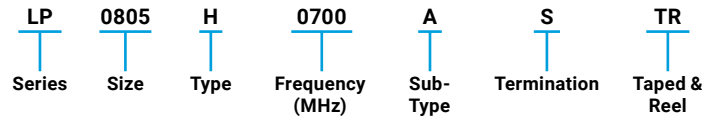

FINAL QUALITY INSPECTION

Finished parts are 100% tested for electrical parameters and visual/mechanical characteristics. Each production lot is evaluated on a sample basis for:

- Static Humidity: 85°C, 85% RH, 160 hours
- Endurance: 125°C, I_R, 4 hours

TERMINATION

Nickel/ Lead free Solder coating (Sn100) compatible with automatic soldering technologies: reflow, wave soldering, vapor phase and manual.

DIMENSIONS (TOP VIEW)

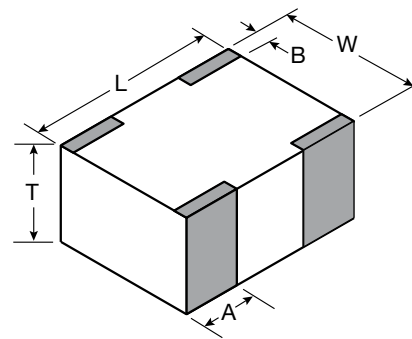

mm (inches)	
L	2.03±0.10 (0.080±0.004)
W	1.55±0.10 (0.061±0.004)
T	0.80±0.10 (0.031±0.004)
A	0.56±0.25 (0.022±0.010)
B	0.35±0.15 (0.014±0.006)

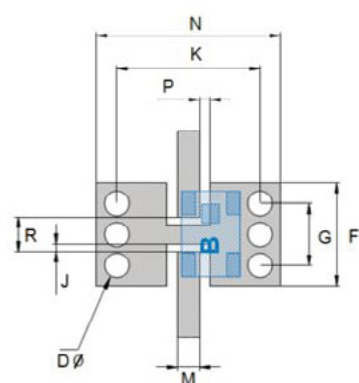

F	2.50±0.05 (0.098±0.002)
G	1.50±0.05 (0.059±0.002)
J	0.19±0.05 (0.007±0.002)
K	3.48±0.05 (0.137±0.002)
M	0.54±0.25 (0.021±0.010)
N	4.48±0.05 (0.776±0.002)
P	0.25±0.05 (0.010±0.002)
R	0.85±0.05 (0.033±0.002)
D	0.60±0.05 (0.024±0.002)

TERMINALS AND LAYOUT (TOP VIEW)

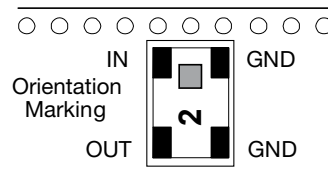

Thin-Film RF/Microwave Filters

Low Pass 0805 High Performance SMD 8W

LP0805H0700ASTR – SMD Termination



ELECTRICAL CHARACTERISTICS

P/N	Frequency	I.Loss @ 700MHz	R.Loss @ 700MHz	Attenuation
LP0805H0700ASTR	700MHz	-0.4dB max.	-20dB	-35dB at 1400MHz -30dB at 2100MHz -30dB at 2800MHz

TYPICAL ELECTRICAL PERFORMANCE

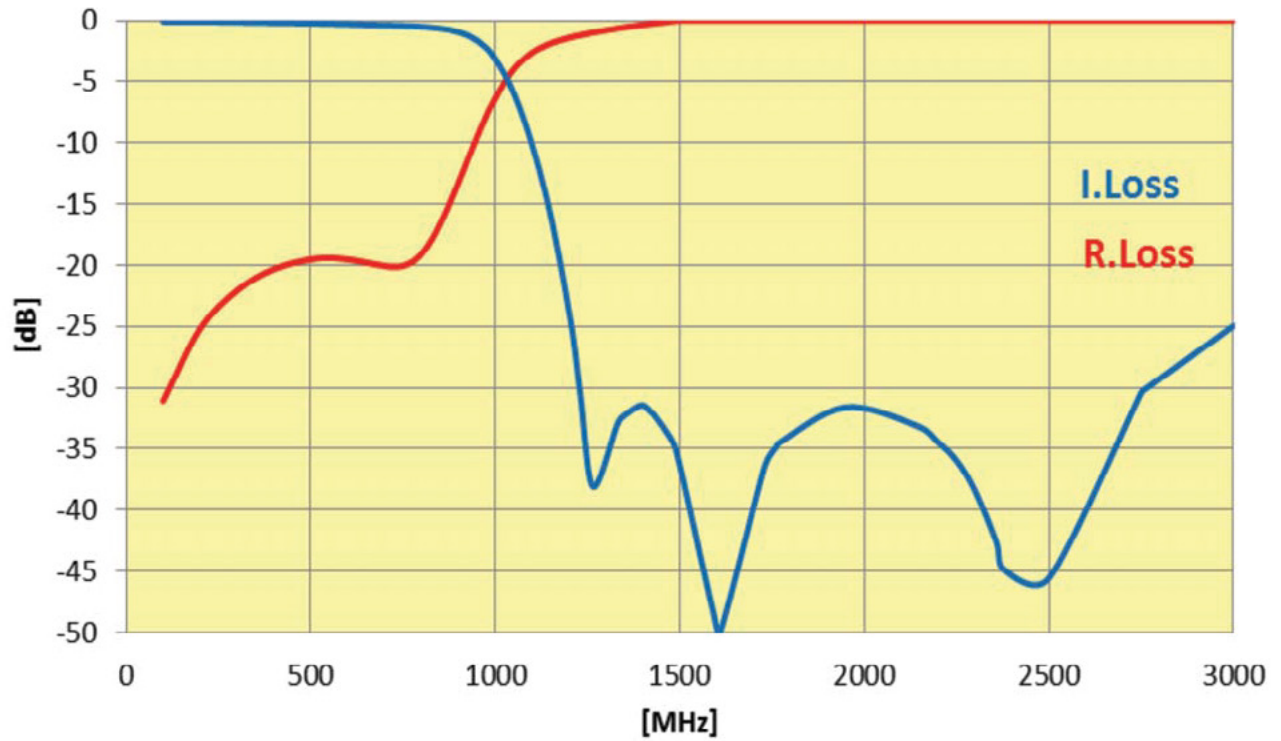

Thin-Film RF/Microwave Filters

Low Pass 0805 High Performance SMD 8W

LP0805H0750ASTR – SMD Termination



ITF TECHNOLOGY

The ITF SMD Filter is based on thin-film multilayer technology. The technology provides a miniature part with excellent high frequency performance and rugged construction for reliable automatic assembly.

The ITF Filter is offered in a variety of frequency bands compatible with various types of high frequency wireless systems.

FEATURES

- Small size: 0805
- Characteristic impedance: 50Ω
- Frequency band: Band 13 746-756MHz
- Operating / Storage temp: -40°C – +85°C
- Low profile
- Rugged construction
- Taped and reeled
- RoHS compliant

APPLICATIONS

- Mobile communications
- Satellite TV receivers
- GPS
- Vehicle location systems
- Wireless LAN's

HOW TO ORDER

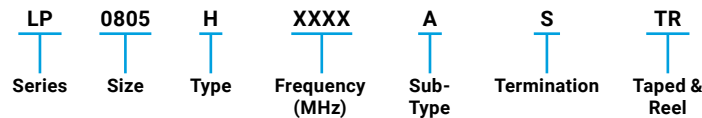

FINAL QUALITY INSPECTION

Finished parts are 100% tested for electrical parameters and visual/mechanical characteristics. Each production lot is evaluated on a sample basis for:

- Static Humidity: 85°C, 85% RH, 160 hours
- Endurance: 125°C, I_r, 4 hours

TERMINATION

Nickel/ Lead free Solder coating (Sn100) compatible with automatic soldering technologies: reflow, wave soldering, vapor phase and manual.

DIMENSIONS (TOP VIEW)

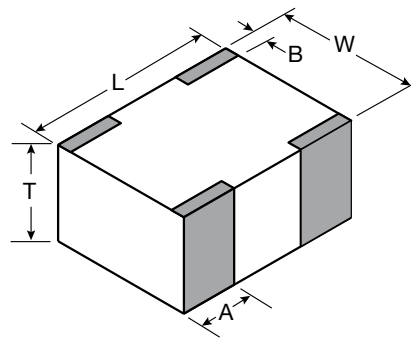

mm (inches)

L	2.03±0.10 (0.080±0.004)
W	1.55±0.10 (0.061±0.004)
T	0.80±0.25 (0.031±0.010)
A	0.56±0.10 (0.022±0.004)
B	0.35±0.15 (0.014±0.006)

TERMINALS AND LAYOUT (TOP VIEW)

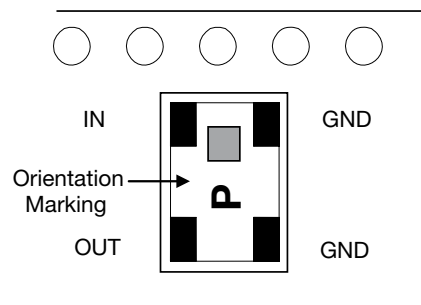

Thin-Film RF/Microwave Filters

Low Pass 0805 High Performance SMD 8W

LP0805H0750ASTR – SMD Termination



ELECTRICAL CHARACTERISTICS

Part Number	Frequency (MHz)	I.Loss max	VSWR max.	Attenuation (dB)
LP0805H0750ASTR	Band 13 DL (746-756MHz)	-0.4dB	1.7	2d Harmonic 1492-1512MHz: -37dB 3d Harmonic 2238-2268MHz: -33dB

TYPICAL ELECTRICAL PERFORMANCE

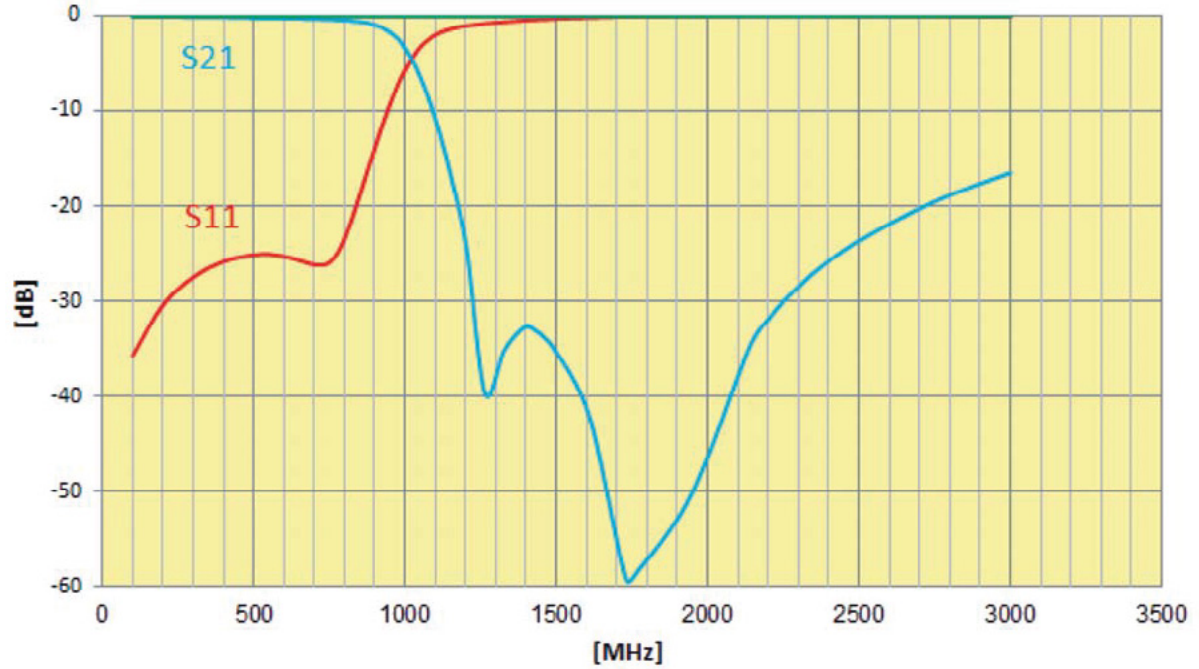

Thin-Film RF/Microwave Filters

Low Pass 0805 High Performance SMD 8W

LP0805H0780ASTR – SMD Termination



ITF TECHNOLOGY

The ITF SMD Filter is based on thin-film multilayer technology. The technology provides a miniature part with excellent high frequency performance and rugged construction for reliable automatic assembly.

The ITF Filter is offered in a variety of frequency bands compatible with various types of high frequency wireless systems.

FEATURES

- Small size: 0805
- Frequency: 780MHz
- Sharp attenuation slope
- Characteristic impedance: 50ohm
- Operating / Storage temp: -40°C – +100°C
- Low profile
- Rugged construction
- Taped and reeled
- Power handling: 8W

APPLICATIONS

- Mobile communications
- Satellite TV receivers
- GPS
- Vehicle location systems
- Wireless LAN's

HOW TO ORDER

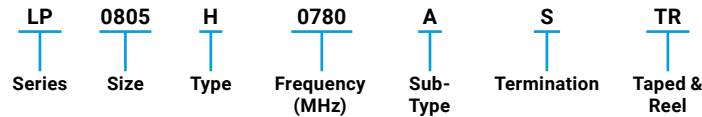

FINAL QUALITY INSPECTION

Finished parts are 100% tested for electrical parameters and visual/mechanical characteristics. Each production lot is evaluated on a sample basis for:

- Static Humidity: 85°C, 85% RH, 160 hours
- Endurance: 125°C, I_R, 4 hours

TERMINATION

Nickel/ Lead free Solder coating (Sn100) compatible with automatic soldering technologies: reflow, wave soldering, vapor phase and manual.

RECOMMENDED PAD LAYOUT:

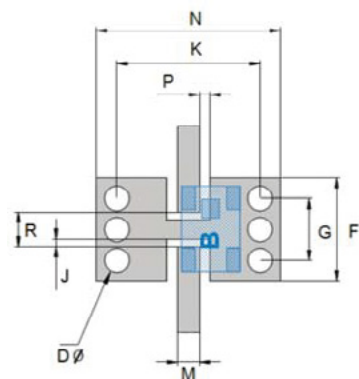

	mm (inches)
F	2.50±0.05 (0.098±0.002)
G	1.50±0.05 (0.059±0.002)
J	0.19±0.05 (0.007±0.002)
K	3.48±0.05 (0.137±0.002)
M	0.54±0.25 (0.021±0.010)
N	4.48±0.05 (0.776±0.002)
P	0.25±0.05 (0.010±0.002)
R	0.85±0.05 (0.033±0.002)
D	0.60±0.05 (0.024±0.002)

DIMENSIONS (TOP VIEW)

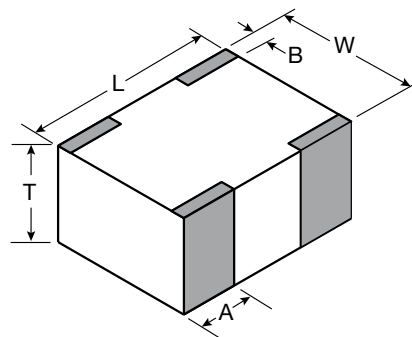

mm (inches)

L	2.03±0.10 (0.080±0.004)
W	1.55±0.10 (0.061±0.004)
T	0.80±0.10 (0.031±0.004)
A	0.56±0.25 (0.022±0.010)
B	0.35±0.15 (0.014±0.006)

TERMINALS AND LAYOUT (TOP VIEW)

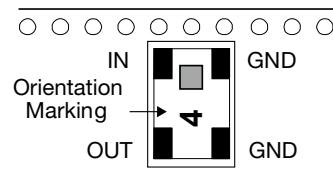

Thin-Film RF/Microwave Filters

Low Pass 0805 High Performance SMD 8W

LP0805H0780ASTR – SMD Termination



ELECTRICAL CHARACTERISTICS

P/N	I.Loss @ 780MHz	R.Loss @ 780MHz	Attenuation
LP0805H0780ASTR	-0.4dB max.	-20dB	-35dB at 1560MHz -40dB at 2340MHz -20dB at 3120MHz

TYPICAL ELECTRICAL PERFORMANCE

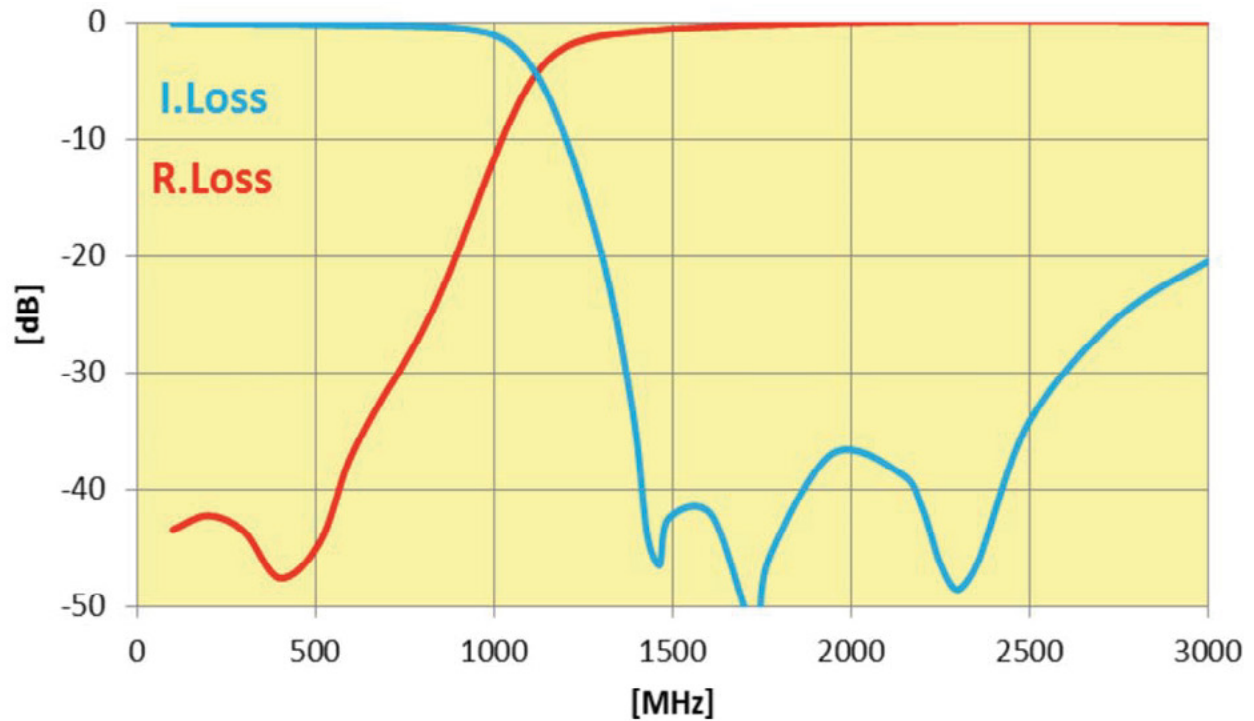

Thin-Film RF/Microwave Filters

Low Pass 0805 High Performance SMD 8W

LP0805H0942ASTR – SMD Termination



ITF TECHNOLOGY

The ITF SMD Filter is based on thin-film multilayer technology. The technology provides a miniature part with excellent high frequency performance and rugged construction for reliable automatic assembly.

The ITF Filter is offered in a variety of frequency bands compatible with various types of high frequency wireless systems.

FEATURES

- Small size: 0805
- Frequency: 942MHz
- Sharp attenuation slope
- Characteristic impedance: 50ohm
- Operating / Storage temp: -40°C – +100°C
- Low profile
- Rugged construction
- Taped and reeled
- Power handling: 8W

APPLICATIONS

- Mobile communications
- Satellite TV receivers
- GPS
- Vehicle location systems
- Wireless LAN's

HOW TO ORDER

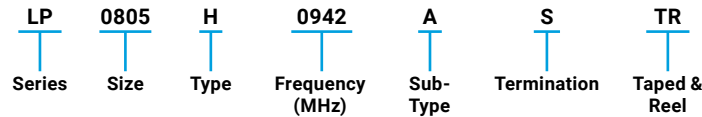

FINAL QUALITY INSPECTION

Finished parts are 100% tested for electrical parameters and visual/mechanical characteristics. Each production lot is evaluated on a sample basis for:

- Static Humidity: 85°C, 85% RH, 160 hours
- Endurance: 125°C, I_R, 4 hours

TERMINATION

Nickel/ Lead free Solder coating (Sn100) compatible with automatic soldering technologies: reflow, wave soldering, vapor phase and manual.

RECOMMENDED PAD LAYOUT:

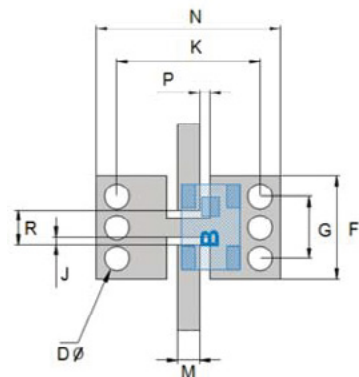

	mm (inches)
F	2.50±0.05 (0.098±0.002)
G	1.50±0.05 (0.059±0.002)
J	0.19±0.05 (0.007±0.002)
K	3.48±0.05 (0.137±0.002)
M	0.54±0.25 (0.021±0.010)
N	4.48±0.05 (0.776±0.002)
P	0.25±0.05 (0.010±0.002)
R	0.85±0.05 (0.033±0.002)
D	0.60±0.05 (0.024±0.002)

DIMENSIONS (TOP VIEW)

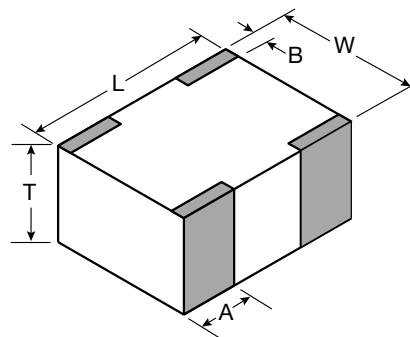

mm (inches)

L	2.03±0.10 (0.080±0.004)
W	1.55±0.10 (0.061±0.004)
T	0.80±0.10 (0.031±0.004)
A	0.56±0.25 (0.022±0.010)
B	0.35±0.15 (0.014±0.006)

TERMINALS AND LAYOUT (TOP VIEW)

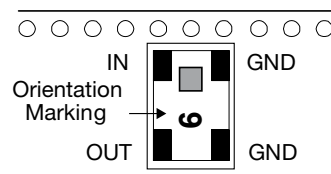

Thin-Film RF/Microwave Filters

Low Pass 0805 High Performance SMD 8W

LP0805H0942ASTR – SMD Termination



ELECTRICAL CHARACTERISTICS

P/N	I.Loss @ 942MHz	R.Loss @ 942MHz	Attenuation
LP0805H0942ASTR	-0.4dB max.	-20dB	-35dB at 1884MHz -40dB at 2826MHz -35dB at 3768MHz

TYPICAL ELECTRICAL PERFORMANCE

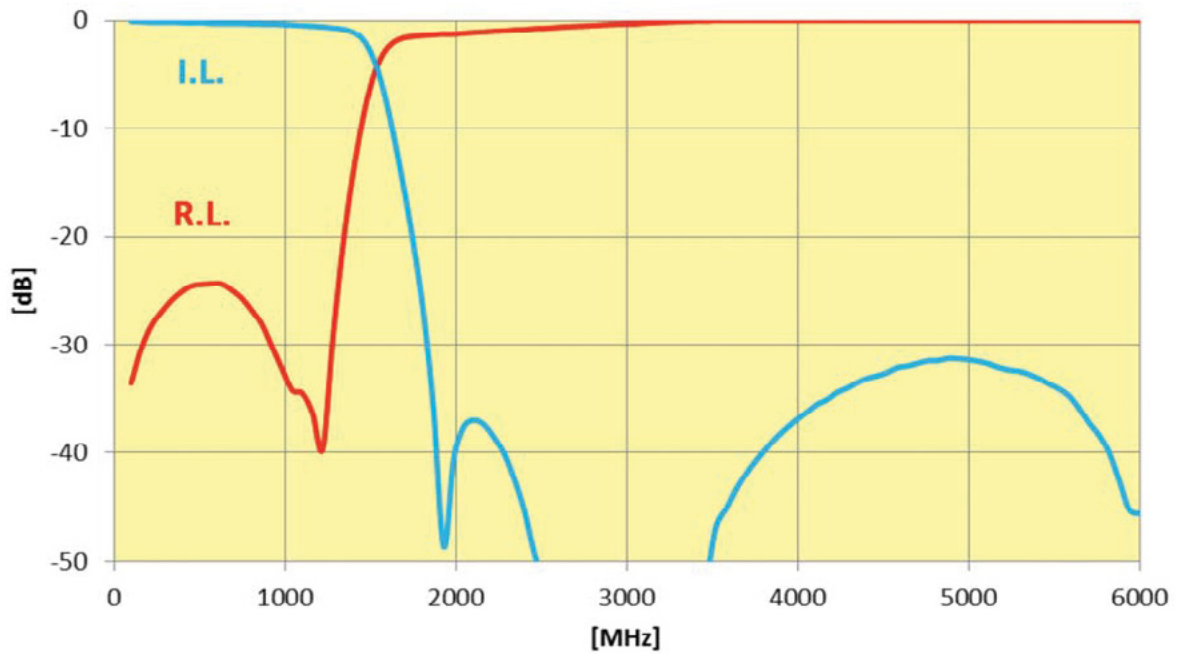

Thin-Film RF/Microwave Filters

Low Pass 0805 High Performance SMD 8W

LP0805H1000ASTR – SMD Termination



ITF TECHNOLOGY

The ITF SMD Filter is based on thin-film multilayer technology. The technology provides a miniature part with excellent high frequency performance and rugged construction for reliable automatic assembly.

The ITF Filter is offered in a variety of frequency bands compatible with various types of high frequency wireless systems.

FEATURES

- Small size: 0805
- Frequency: 1000MHz
- Sharp attenuation slope
- Characteristic impedance: 50ohm
- Operating / Storage temp: -40°C – +100°C
- Low profile
- Rugged construction
- Taped and reeled
- Power handling: 8W

APPLICATIONS

- Mobile communications
- Satellite TV receivers
- GPS
- Vehicle location systems
- Wireless LAN's

HOW TO ORDER

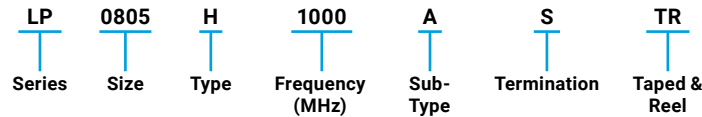

FINAL QUALITY INSPECTION

Finished parts are 100% tested for electrical parameters and visual/mechanical characteristics. Each production lot is evaluated on a sample basis for:

- Static Humidity: 85°C, 85% RH, 160 hours
- Endurance: 125°C, I_R, 4 hours

TERMINATION

Nickel/ Lead free Solder coating (Sn100) compatible with automatic soldering technologies: reflow, wave soldering, vapor phase and manual.

RECOMMENDED PAD LAYOUT:

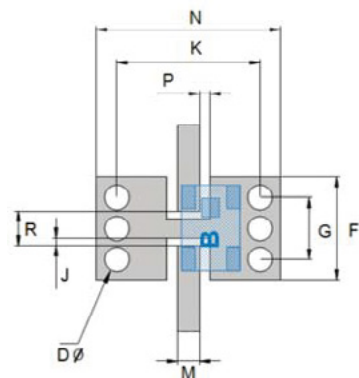

	mm (inches)
F	2.50±0.05 (0.098±0.002)
G	1.50±0.05 (0.059±0.002)
J	0.19±0.05 (0.007±0.002)
K	3.48±0.05 (0.137±0.002)
M	0.54±0.25 (0.021±0.010)
N	4.48±0.05 (0.776±0.002)
P	0.25±0.05 (0.010±0.002)
R	0.85±0.05 (0.033±0.002)
D	0.60±0.05 (0.024±0.002)

DIMENSIONS (TOP VIEW)

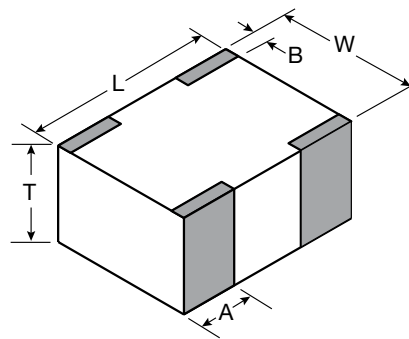

mm (inches)

L	2.03±0.10 (0.080±0.004)
W	1.55±0.10 (0.061±0.004)
T	0.80±0.10 (0.031±0.004)
A	0.56±0.25 (0.022±0.010)
B	0.35±0.15 (0.014±0.006)

TERMINAL AND LAYOUT (TOP VIEW)

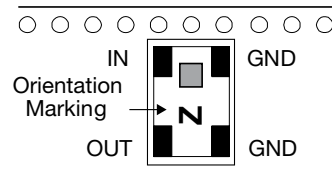

Thin-Film RF/Microwave Filters

Low Pass 0805 High Performance SMD 8W

LP0805H1000ASTR – SMD Termination



ELECTRICAL CHARACTERISTICS

P/N	I.Loss @ 1000MHz	R.Loss @ 1000MHz	Attenuation
LP0805H1000ASTR	-0.7dB max.	-20dB	-35dB at 2000MHz -40dB at 3000MHz -35dB at 4000MHz -30dB at 5000MHz

TYPICAL ELECTRICAL PERFORMANCE

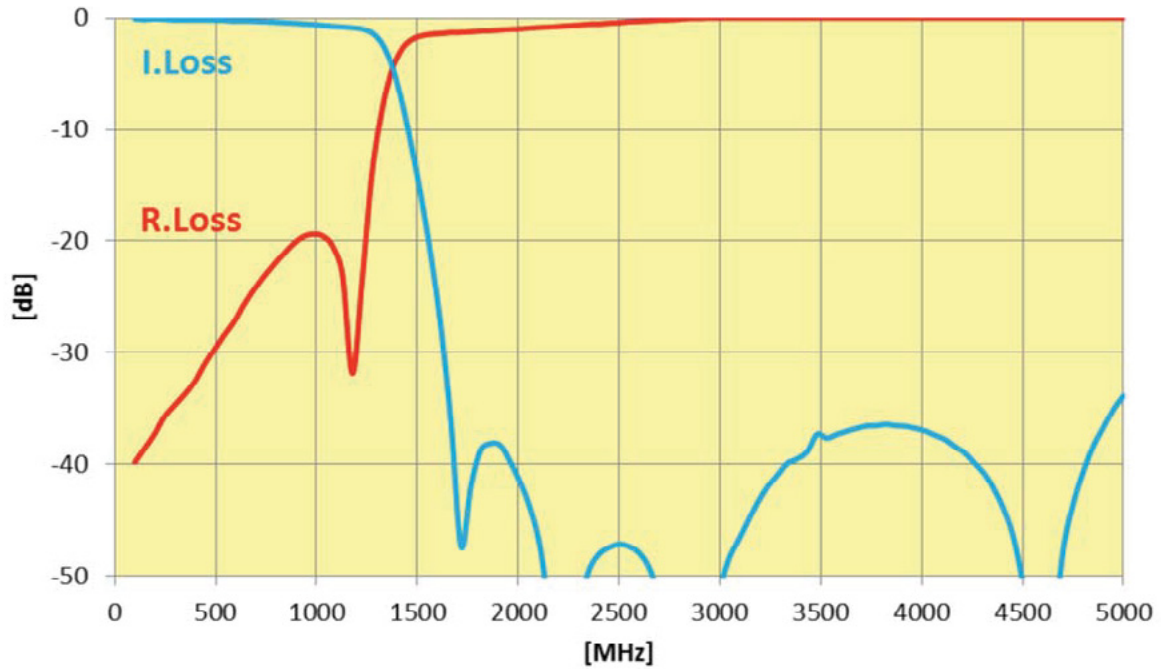

Thin-Film RF/Microwave Filters

Low Pass 0805 High Performance SMD 8W

LP0805H1250ASTR – SMD Termination



ITF TECHNOLOGY

The ITF SMD Filter is based on thin-film multilayer technology. The technology provides a miniature part with excellent high frequency performance and rugged construction for reliable automatic assembly.

The ITF Filter is offered in a variety of frequency bands compatible with various types of high frequency wireless systems.

FEATURES

- Small size: 0805
- Frequency: 1250MHz
- Sharp attenuation slope
- Characteristic impedance: 50ohm
- Operating / Storage temp: -40°C – +100°C
- Low profile
- Rugged construction
- Taped and reeled
- Power handling: 8W

APPLICATIONS

- Mobile communications
- Satellite TV receivers
- GPS
- Vehicle location systems
- Wireless LAN's

HOW TO ORDER

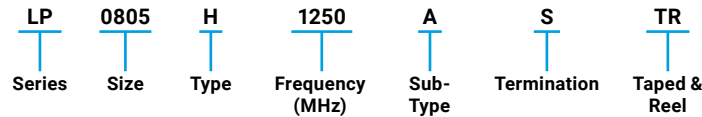

FINAL QUALITY INSPECTION

Finished parts are 100% tested for electrical parameters and visual/mechanical characteristics. Each production lot is evaluated on a sample basis for:

- Static Humidity: 85°C, 85% RH, 160 hours
- Endurance: 125°C, I_R, 4 hours

TERMINATION

Nickel/ Lead free Solder coating (Sn100) compatible with automatic soldering technologies: reflow, wave soldering, vapor phase and manual.

RECOMMENDED PAD LAYOUT:

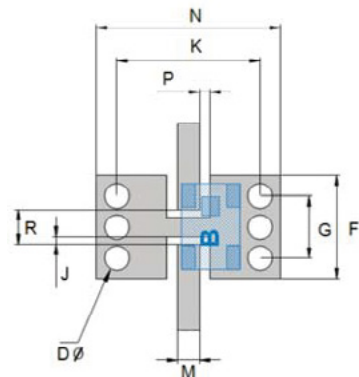

	mm (inches)
F	2.50±0.05 (0.098±0.002)
G	1.50±0.05 (0.059±0.002)
J	0.19±0.05 (0.007±0.002)
K	3.48±0.05 (0.137±0.002)
M	0.54±0.25 (0.021±0.010)
N	4.48±0.05 (0.776±0.002)
P	0.25±0.05 (0.010±0.002)
R	0.85±0.05 (0.033±0.002)
D	0.60±0.05 (0.024±0.002)

DIMENSIONS (TOP VIEW)

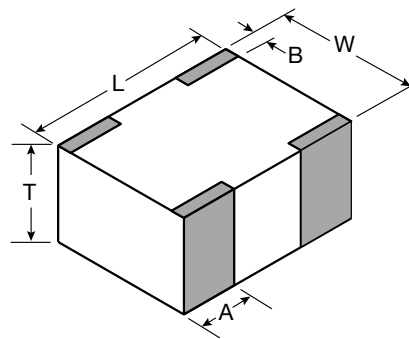

mm (inches)

L	2.03±0.10 (0.080±0.004)
W	1.55±0.10 (0.061±0.004)
T	0.80±0.10 (0.031±0.004)
A	0.56±0.25 (0.022±0.010)
B	0.35±0.15 (0.014±0.006)

TERMINAL AND LAYOUT (TOP VIEW)

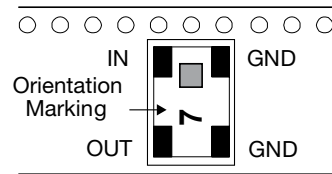

Thin-Film RF/Microwave Filters

Low Pass 0805 High Performance SMD 8W

LP0805H1250ASTR – SMD Termination



ELECTRICAL CHARACTERISTICS

P/N	I.Loss @1250MHz	R.Loss @ 1250MHz	Attenuation
LP0805H1250ASTR	-0.7dB max.	-25dB	-20dB at 1750MHz -35dB at 2500MHz -40dB at 3750MHz -30dB at 5000MHz

TYPICAL ELECTRICAL PERFORMANCE

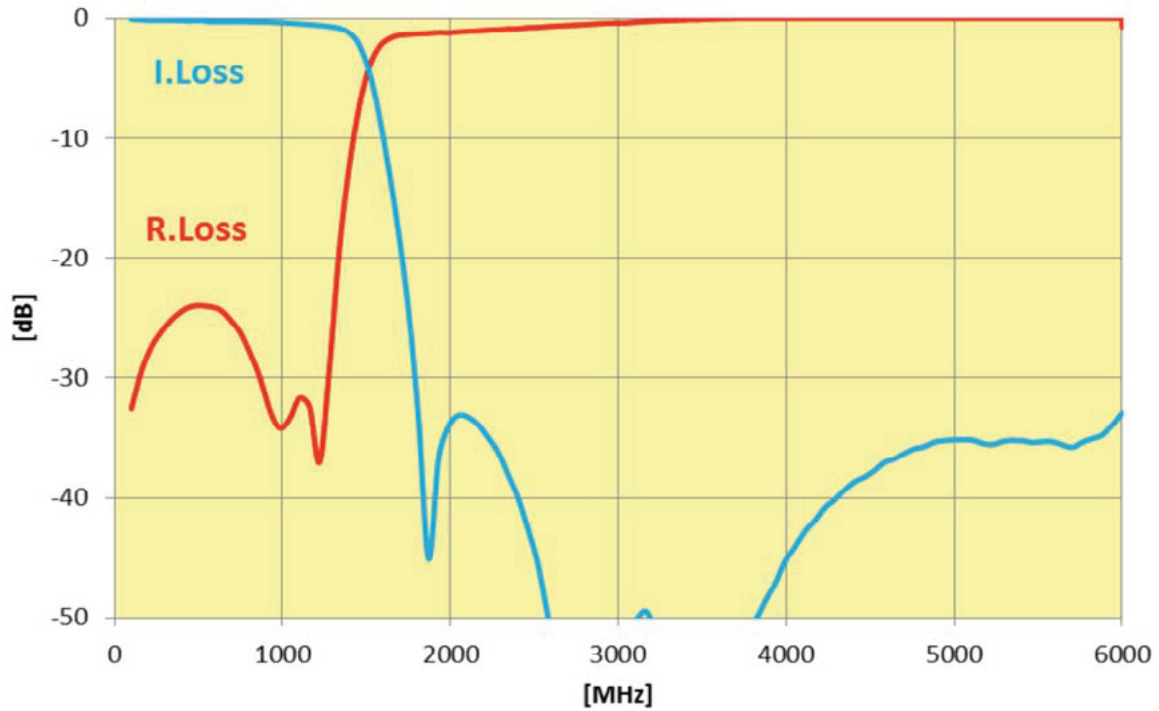

Thin-Film RF/Microwave Filters

Low Pass 0805 High Performance SMD 8W

LP0805H1800ASTR – SMD Termination



ITF TECHNOLOGY

The ITF SMD Filter is based on thin-film multilayer technology. The technology provides a miniature part with excellent high frequency performance and rugged construction for reliable automatic assembly.

The ITF Filter is offered in a variety of frequency bands compatible with various types of high frequency wireless systems.

FEATURES

- Small size: 0805
- Frequency: 1800MHz
- Sharp attenuation slope
- Characteristic impedance: 50ohm
- Operating / Storage temp: -40°C – +100°C
- Low profile
- Rugged construction
- Taped and reeled
- Power handling: 8W

APPLICATIONS

- Mobile communications
- Satellite TV receivers
- GPS
- Vehicle location systems
- Wireless LAN's

HOW TO ORDER

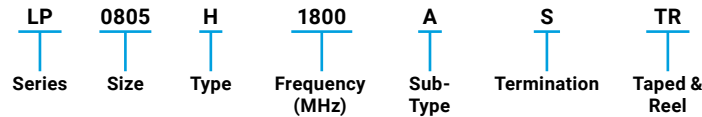

FINAL QUALITY INSPECTION

Finished parts are 100% tested for electrical parameters and visual/mechanical characteristics. Each production lot is evaluated on a sample basis for:

- Static Humidity: 85°C, 85% RH, 160 hours
- Endurance: 125°C, I_R, 4 hours

TERMINATION

Nickel/ Lead free Solder coating (Sn100) compatible with automatic soldering technologies: reflow, wave soldering, vapor phase and manual.

RECOMMENDED PAD LAYOUT:

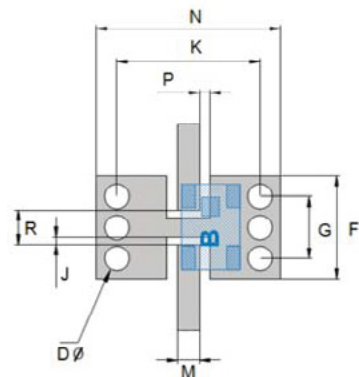

	mm (inches)
F	2.50±0.05 (0.098±0.002)
G	1.50±0.05 (0.059±0.002)
J	0.19±0.05 (0.007±0.002)
K	3.48±0.05 (0.137±0.002)
M	0.54±0.25 (0.021±0.010)
N	4.48±0.05 (0.776±0.002)
P	0.25±0.05 (0.010±0.002)
R	0.85±0.05 (0.033±0.002)
D	0.60±0.05 (0.024±0.002)

DIMENSIONS (TOP VIEW)

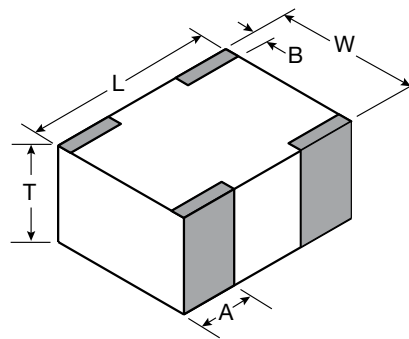

mm (inches)

L	2.03±0.10 (0.080±0.004)
W	1.55±0.10 (0.061±0.004)
T	0.80±0.10 (0.031±0.004)
A	0.56±0.25 (0.022±0.010)
B	0.35±0.15 (0.014±0.006)

TERMINAL AND LAYOUT (TOP VIEW)

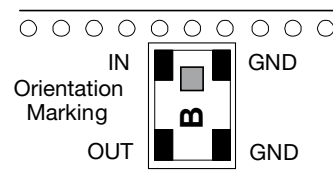

Thin-Film RF/Microwave Filters

Low Pass 0805 High Performance SMD 8W

LP0805H1800ASTR – SMD Termination



ELECTRICAL CHARACTERISTICS

P/N	Frequency	I.Loss @1800MHz	R.Loss @ 1800MHz	Attenuation
LP0805H1800ASTR	1800MHz	-0.8dB max.	-25dB	-35dB at 2520MHz -35dB at 3600MHz -25dB at 5400MHz

TYPICAL ELECTRICAL PERFORMANCE

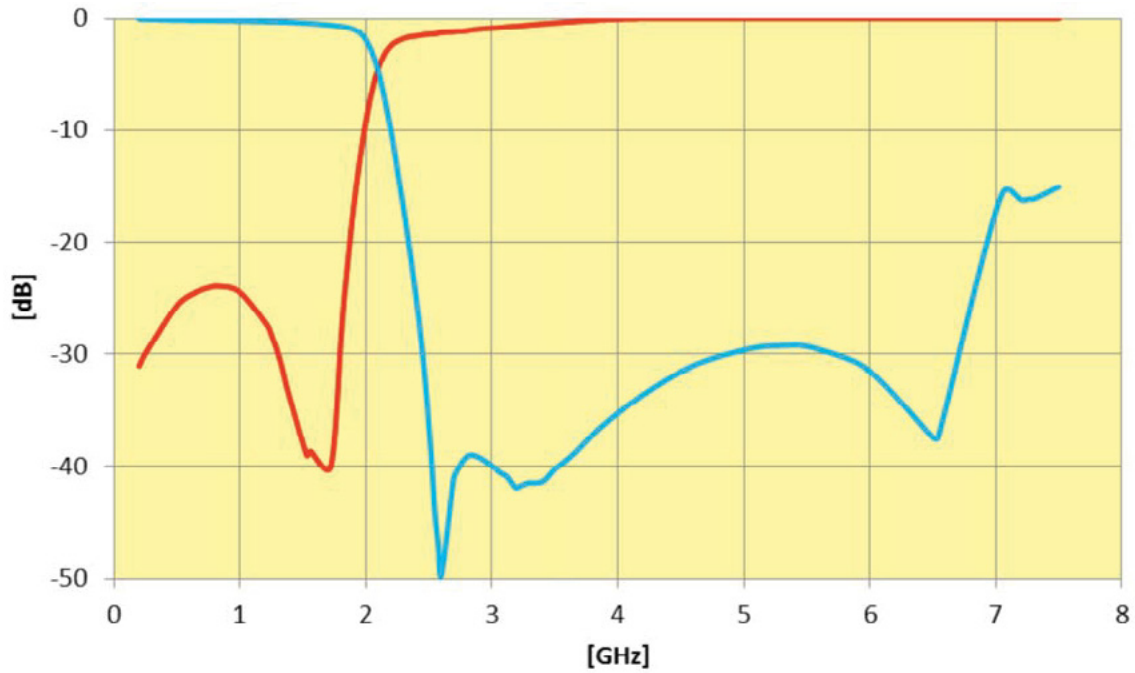

Thin-Film RF/Microwave Filters

Low Pass 0805 High Performance SMD 8W

LP0805H1900ASTR – SMD Termination



ITF TECHNOLOGY

The ITF SMD Filter is based on thin-film multilayer technology. The technology provides a miniature part with excellent high frequency performance and rugged construction for reliable automatic assembly.

The ITF Filter is offered in a variety of frequency bands compatible with various types of high frequency wireless systems.

FEATURES

- Small size: 0805
- Frequency: 1900MHz
- Sharp attenuation slope
- Characteristic impedance: 50ohm
- Operating / Storage temp: -40°C – +100°C
- Low profile
- Rugged construction
- Taped and reeled
- Power handling: 8W

APPLICATIONS

- Mobile communications
- Satellite TV receivers
- GPS
- Vehicle location systems
- Wireless LAN's

HOW TO ORDER

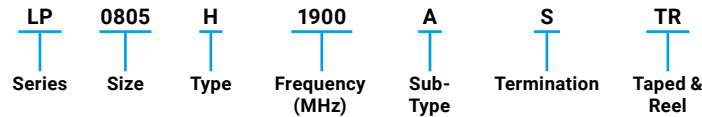

FINAL QUALITY INSPECTION

Finished parts are 100% tested for electrical parameters and visual/mechanical characteristics. Each production lot is evaluated on a sample basis for:

- Static Humidity: 85°C, 85% RH, 160 hours
- Endurance: 125°C, I_R, 4 hours

TERMINATION

Nickel/ Lead free Solder coating (Sn100) compatible with automatic soldering technologies: reflow, wave soldering, vapor phase and manual.

RECOMMENDED PAD LAYOUT:

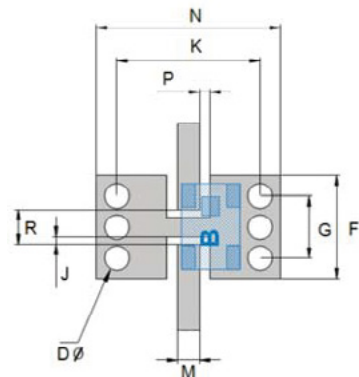

	mm (inches)
F	2.50±0.05 (0.098±0.002)
G	1.50±0.05 (0.059±0.002)
J	0.19±0.05 (0.007±0.002)
K	3.48±0.05 (0.137±0.002)
M	0.54±0.25 (0.021±0.010)
N	4.48±0.05 (0.776±0.002)
P	0.25±0.05 (0.010±0.002)
R	0.85±0.05 (0.033±0.002)
D	0.60±0.05 (0.024±0.002)

DIMENSIONS (TOP VIEW)

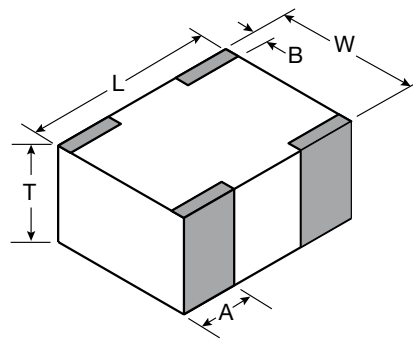

mm (inches)

L	2.03±0.10 (0.080±0.004)
W	1.55±0.10 (0.061±0.004)
T	0.80±0.10 (0.031±0.004)
A	0.56±0.25 (0.022±0.010)
B	0.35±0.15 (0.014±0.006)

TERMINAL AND LAYOUT (TOP VIEW)

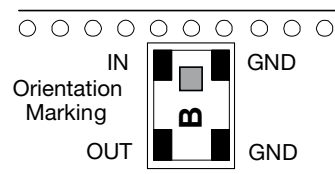

Thin-Film RF/Microwave Filters

Low Pass 0805 High Performance SMD 8W

LP0805H1900ASTR – SMD Termination



ELECTRICAL CHARACTERISTICS

P/N	Frequency	I.Loss @1900MHz	R.Loss @ 1900MHz	Attenuation
LP0805H1900ASTR	1900MHz	-0.75dB max.	-20dB	-35dB at 2660MHz -35dB at 3800MHz -25dB at 5700MHz

TYPICAL ELECTRICAL PERFORMANCE

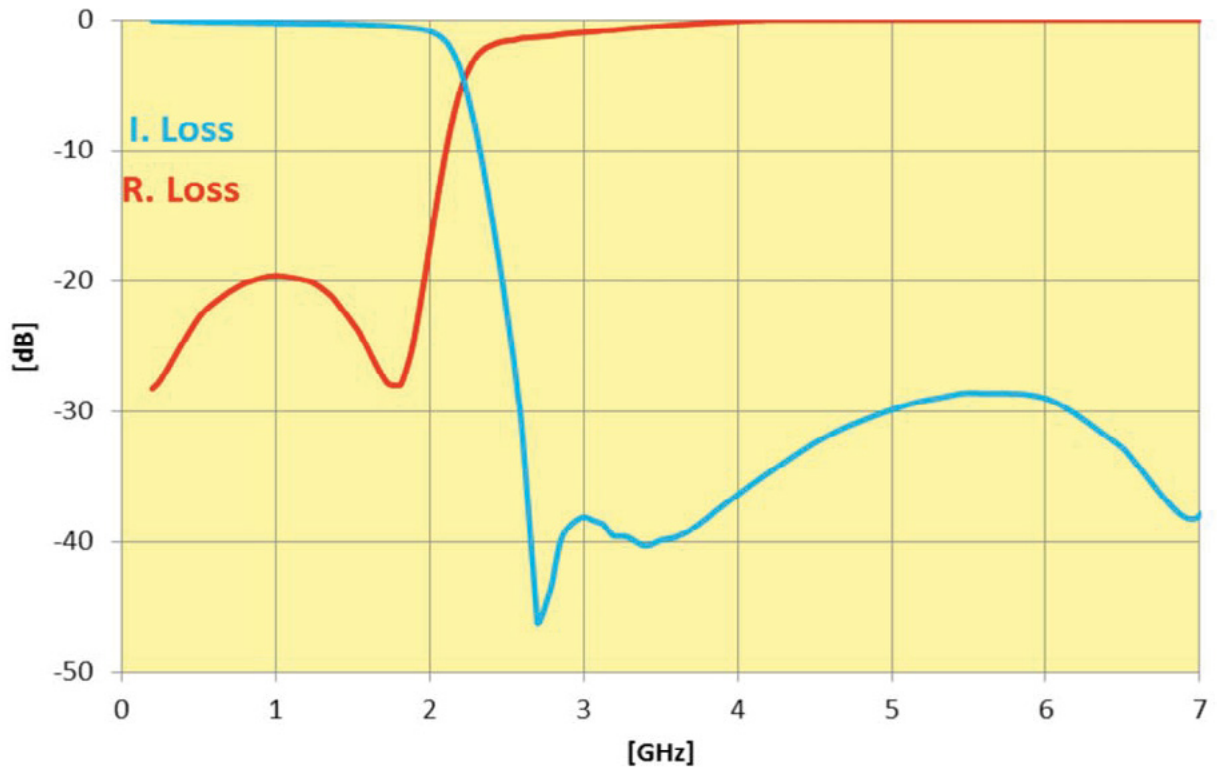

Thin-Film RF/Microwave Filters

Low Pass 0805 High Performance SMD 8W

LP0805H2400ASTR – SMD Termination

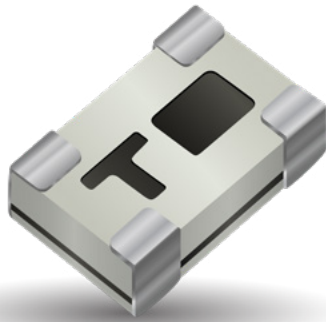

ITF TECHNOLOGY

The ITF SMD Filter is based on thin-film multilayer technology. The technology provides a miniature part with excellent high frequency performance and rugged construction for reliable automatic assembly.

The ITF Filter is offered in a variety of frequency bands compatible with various types of high frequency wireless systems.

FEATURES

- Small size: 0805
- Frequency: 1900MHz
- Sharp attenuation slope
- Characteristic impedance: 50ohm
- Operating / Storage temp: -40°C – +100°C
- Low profile
- Rugged construction
- Taped and reeled
- Power handling: 8W

APPLICATIONS

- Mobile communications
- Satellite TV receivers
- GPS
- Vehicle location systems
- Wireless LAN's

HOW TO ORDER

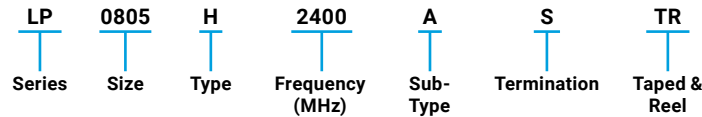

FINAL QUALITY INSPECTION

Finished parts are 100% tested for electrical parameters and visual/mechanical characteristics. Each production lot is evaluated on a sample basis for:

- Static Humidity: 85°C, 85% RH, 160 hours
- Endurance: 125°C, I_R, 4 hours

TERMINATION

Nickel/ Lead free Solder coating (Sn100) compatible with automatic soldering technologies: reflow, wave soldering, vapor phase and manual.

RECOMMENDED PAD LAYOUT:

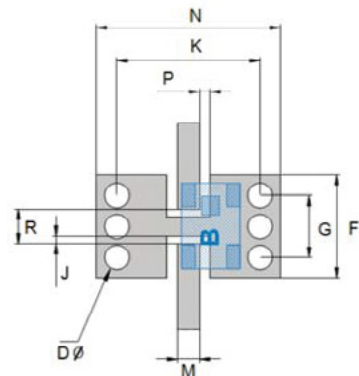

mm (inches)

F	2.50±0.05 (0.098±0.002)
G	1.50±0.05 (0.059±0.002)
J	0.19±0.05 (0.007±0.002)
K	3.48±0.05 (0.137±0.002)
M	0.54±0.25 (0.021±0.010)
N	4.48±0.05 (0.776±0.002)
P	0.25±0.05 (0.010±0.002)
R	0.85±0.05 (0.033±0.002)
D	0.60±0.05 (0.024±0.002)

DIMENSIONS (TOP VIEW)

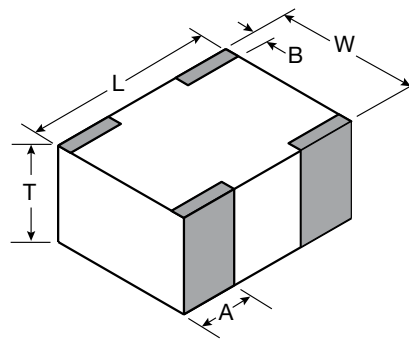

mm (inches)

L	2.03±0.10 (0.080±0.004)
W	1.55±0.10 (0.061±0.004)
T	0.80±0.10 (0.031±0.004)
A	0.56±0.25 (0.022±0.010)
B	0.35±0.15 (0.014±0.006)

TERMINAL AND LAYOUT (TOP VIEW)

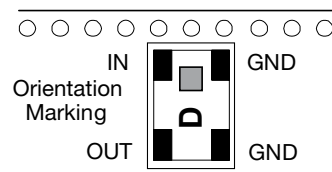

Thin-Film RF/Microwave Filters

Low Pass 0805 High Performance SMD 8W

LP0805H2400ASTR – SMD Termination



ELECTRICAL CHARACTERISTICS

P/N	Frequency	I.Loss @2500MHz	R.Loss @ 2500MHz	Attenuation
LP0805H2400ASTR	2400MHz	-0.9dB max.	-30dB	-30dB at 3360MHz -25dB at 4800MHz -30dB at 7200MHz

TYPICAL ELECTRICAL PERFORMANCE

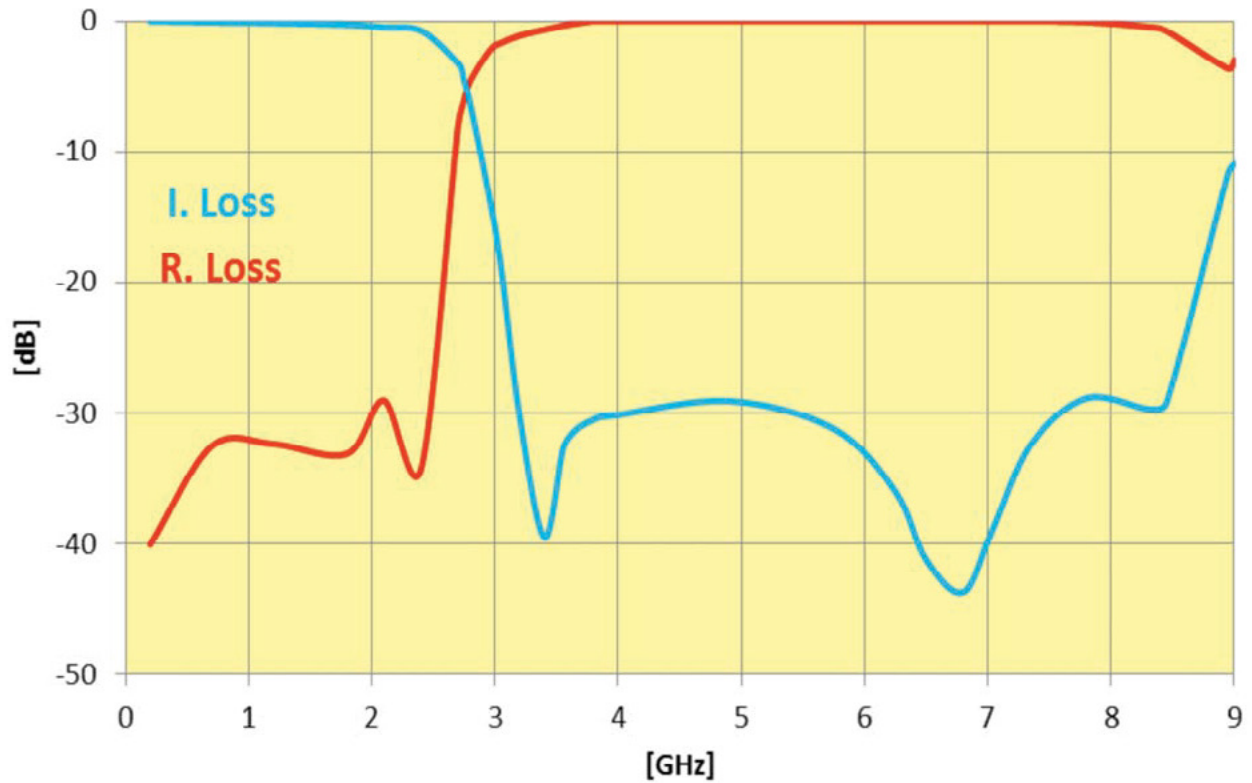

Thin-Film RF/Microwave Filters

Low Pass 0805 High Performance Low Pass Filter

LP0805H2500ASTR – SMD Termination



ITF TECHNOLOGY

The ITF SMD Filter is based on thin-film multilayer technology. The technology provides a miniature part with excellent high frequency performance and rugged construction for reliable automatic assembly.

The ITF Filter is offered in a variety of frequency bands compatible with various types of high frequency wireless systems.

FEATURES

- Small size: 0805
- Frequency: 2500MHz
- Sharp attenuation slope
- Characteristic impedance: 50ohm
- Operating / Storage temp: -40°C – +100°C
- Low profile
- Rugged construction
- Taped and reeled
- Power handling: 8W

APPLICATIONS

- Mobile communications
- Satellite TV receivers
- GPS
- Vehicle location systems
- Wireless LAN's

HOW TO ORDER

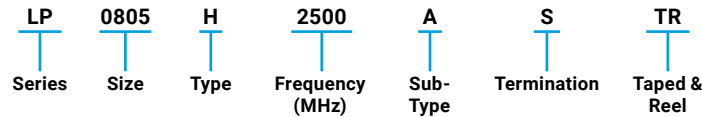

FINAL QUALITY INSPECTION

Finished parts are 100% tested for electrical parameters and visual/mechanical characteristics. Each production lot is evaluated on a sample basis for:

- Static Humidity: 85°C, 85% RH, 160 hours
- Endurance: 125°C, I_R, 4 hours

TERMINATION

Nickel/ Lead free Solder coating (Sn100) compatible with automatic soldering technologies: reflow, wave soldering, vapor phase and manual.

RECOMMENDED PAD LAYOUT:

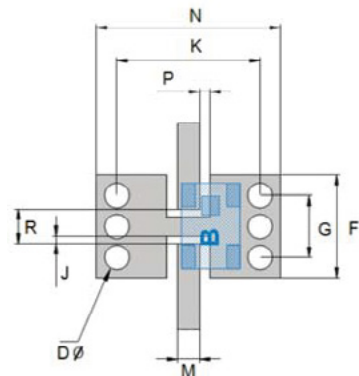

mm (inches)

F	2.50±0.05 (0.098±0.002)
G	1.50±0.05 (0.059±0.002)
J	0.19±0.05 (0.007±0.002)
K	3.48±0.05 (0.137±0.002)
M	0.54±0.25 (0.021±0.010)
N	4.48±0.05 (0.776±0.002)
P	0.25±0.05 (0.010±0.002)
R	0.85±0.05 (0.033±0.002)
D	0.60±0.05 (0.024±0.002)

DIMENSIONS (TOP VIEW)

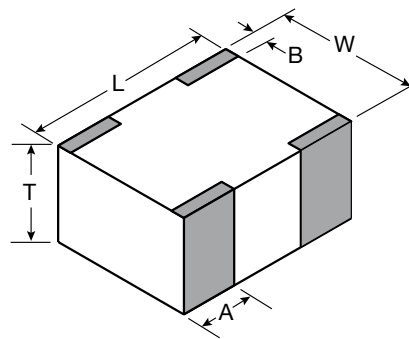

mm (inches)

L	2.03±0.10 (0.080±0.004)
W	1.55±0.10 (0.061±0.004)
T	0.80±0.10 (0.031±0.004)
A	0.56±0.25 (0.022±0.010)
B	0.35±0.15 (0.014±0.006)

TERMINAL AND LAYOUT (TOP VIEW)

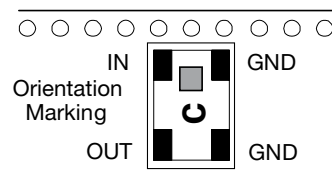

Thin-Film RF/Microwave Filters

Low Pass 0805 High Performance Low Pass Filter

LP0805H2500ASTR – SMD Termination



ELECTRICAL CHARACTERISTICS

P/N	I.Loss @2500MHz	R.Loss @ 2500MHz	Attenuation
LP0805H2500ASTR	-0.8dB max.	-15dB	-28dB at 4000-6000MHz -20dB at 6001-8000MHz

TYPICAL ELECTRICAL PERFORMANCE

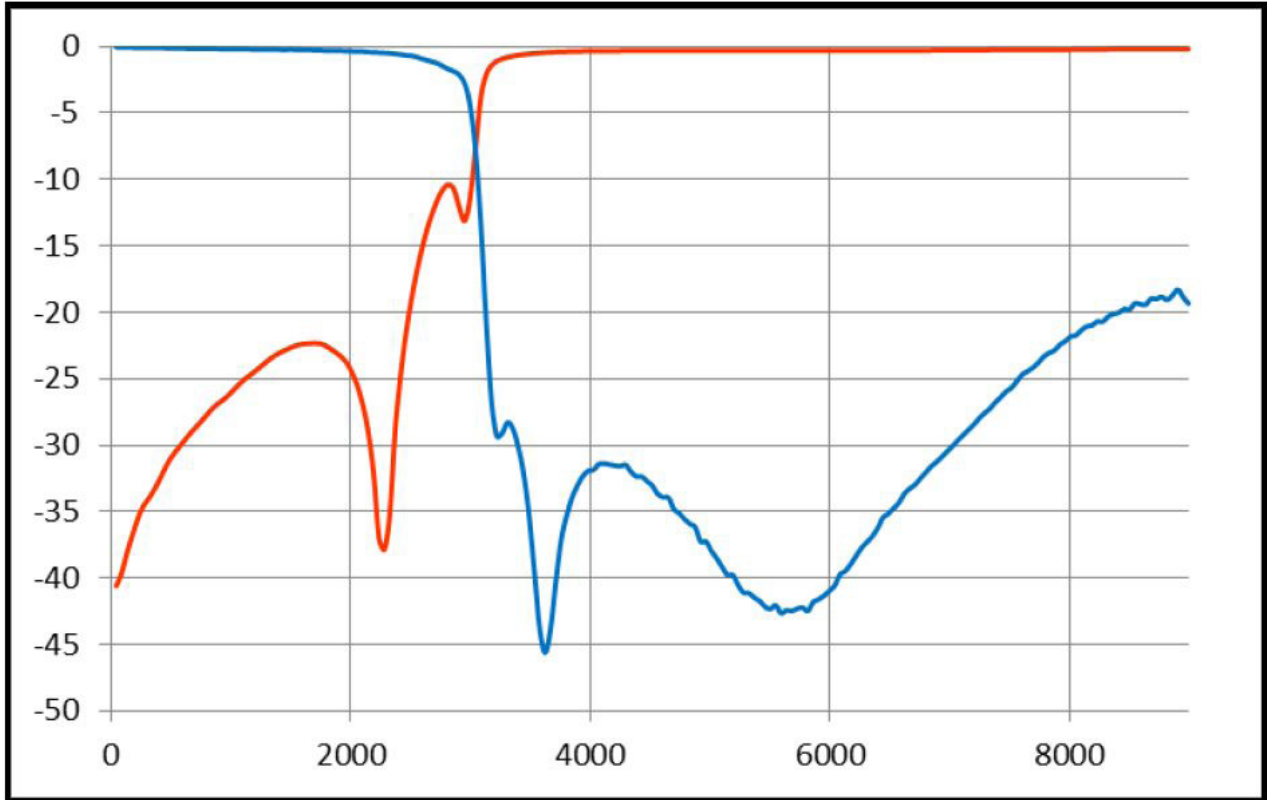

Thin-Film RF/Microwave Filters

Low Pass 0805 High Performance Low Pass Filter

LP0805H2600ASTR – SMD Termination



ITF TECHNOLOGY

The ITF SMD Filter is based on thin-film multilayer technology. The technology provides a miniature part with excellent high frequency performance and rugged construction for reliable automatic assembly.

The ITF Filter is offered in a variety of frequency bands compatible with various types of high frequency wireless systems.

FEATURES

- Small size: 0805
- Frequency: 2600MHz
- Sharp attenuation slope
- Characteristic impedance: 50Ohm
- Operating / Storage temp: -40°C – +100°C
- Low profile
- Rugged construction
- Taped and reeled
- Power handling: 8W

APPLICATIONS

- Mobile communications
- Satellite TV receivers
- GPS
- Vehicle location systems
- Wireless LAN's

HOW TO ORDER

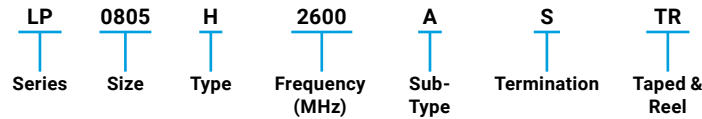

FINAL QUALITY INSPECTION

Finished parts are 100% tested for electrical parameters and visual/mechanical characteristics. Each production lot is evaluated on a sample basis for:

- Static Humidity: 85°C, 85% RH, 160 hours
- Endurance: 125°C, I_R, 4 hours

TERMINATION

Nickel/ Lead free Solder coating (Sn100) compatible with automatic soldering technologies: reflow, wave soldering, vapor phase and manual.

RECOMMENDED PAD LAYOUT:

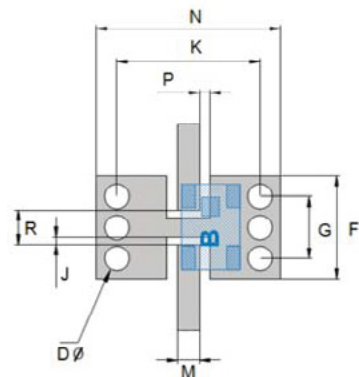

	mm (inches)
F	2.50±0.05 (0.098±0.002)
G	1.50±0.05 (0.059±0.002)
J	0.19±0.05 (0.007±0.002)
K	3.48±0.05 (0.137±0.002)
M	0.54±0.25 (0.021±0.010)
N	4.48±0.05 (0.776±0.002)
P	0.25±0.05 (0.010±0.002)
R	0.85±0.05 (0.033±0.002)
D	0.60±0.05 (0.024±0.002)

DIMENSIONS (TOP VIEW)

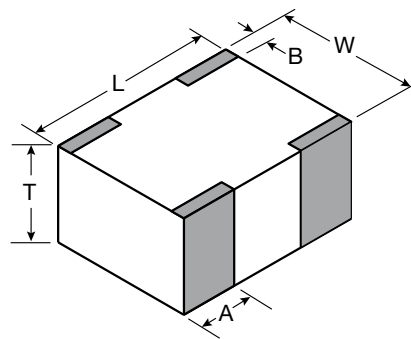

mm (inches)

L	2.03±0.10 (0.080±0.004)
W	1.55±0.10 (0.061±0.004)
T	0.80±0.10 (0.031±0.004)
A	0.56±0.25 (0.022±0.010)
B	0.35±0.15 (0.014±0.006)

TERMINAL AND LAYOUT (TOP VIEW)

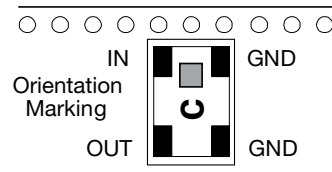

Thin-Film RF/Microwave Filters

Low Pass 0805 High Performance Low Pass Filter

LP0805H2600ASTR – SMD Termination



ELECTRICAL CHARACTERISTICS

P/N	I.Loss @2600MHz	R.Loss @ 2600MHz	Attenuation
LP0805H2600ASTR	-0.9dB max.	-15dB	-28dB at 4000-6000MHz -20dB at 6001-8000MHz

TYPICAL ELECTRICAL PERFORMANCE

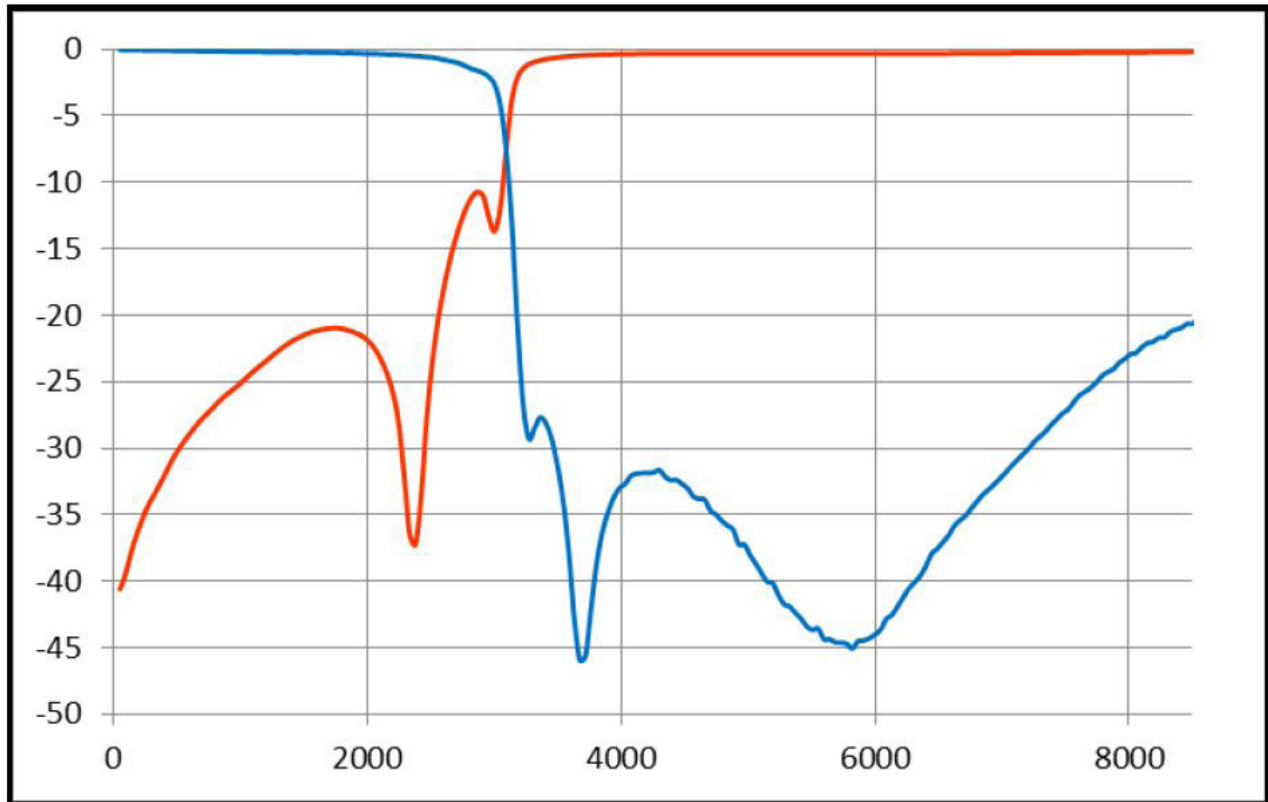

Thin-Film RF/Microwave Filters

Low Pass 0805 High Performance SMD 8W

LP0805H2900ASTR – SMD Termination



ITF TECHNOLOGY

The ITF SMD Filter is based on thin-film multilayer technology. The technology provides a miniature part with excellent high frequency performance and rugged construction for reliable automatic assembly.

The ITF Filter is offered in a variety of frequency bands compatible with various types of high frequency wireless systems.

FEATURES

- Frequency: 1700-2900MHz
- Characteristic impedance: 50ohm
- Operating / Storage temp: -40°C – +100°C
- Low profile
- Rugged construction
- Taped and reeled
- Power handling: 8W

APPLICATIONS

- Mobile communications
- Satellite TV receivers
- GPS
- Vehicle location systems
- Wireless LAN's

HOW TO ORDER

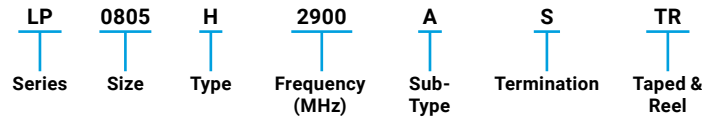

FINAL QUALITY INSPECTION

Finished parts are 100% tested for electrical parameters and visual/mechanical characteristics. Each production lot is evaluated on a sample basis for:

- Static Humidity: 85°C, 85% RH, 160 hours
- Endurance: 125°C, I_R, 4 hours

TERMINATION

Nickel/ Lead free Solder coating (Sn100) compatible with automatic soldering technologies: reflow, wave soldering, vapor phase and manual.

RECOMMENDED PAD LAYOUT:

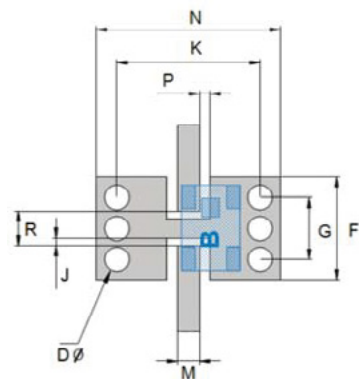

Dimension	mm (inches)
F	2.50±0.05 (0.098±0.002)
G	1.50±0.05 (0.059±0.002)
J	0.19±0.05 (0.007±0.002)
K	3.48±0.05 (0.137±0.002)
M	0.54±0.25 (0.021±0.010)
N	4.48±0.05 (0.776±0.002)
P	0.25±0.05 (0.010±0.002)
R	0.85±0.05 (0.033±0.002)
D	0.60±0.05 (0.024±0.002)

DIMENSIONS (TOP VIEW)

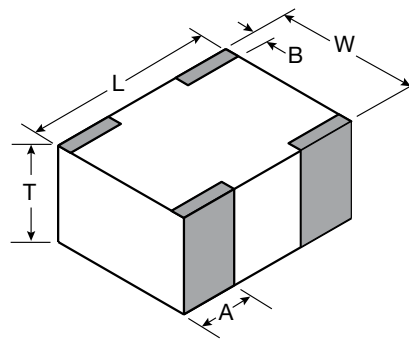

mm (inches)

Dimension	mm (inches)
L	2.03±0.10 (0.080±0.004)
W	1.55±0.10 (0.061±0.004)
T	0.80±0.10 (0.031±0.004)
A	0.56±0.25 (0.022±0.010)
B	0.35±0.15 (0.014±0.006)

TERMINAL AND LAYOUT (TOP VIEW)

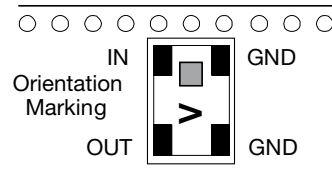

Thin-Film RF/Microwave Filters

Low Pass 0805 High Performance SMD 8W

LP0805H2900ASTR – SMD Termination



ELECTRICAL CHARACTERISTICS

P/N	Frequency	I.Loss @2900MHz	R.Loss @ 2900MHz	Attenuation
LP0805H2900ASTR	2900MHz	-1dB max.	-20dB	-30dB at 4060MHz -30dB at 5800MHz -35dB at 6500MHz

TYPICAL ELECTRICAL PERFORMANCE

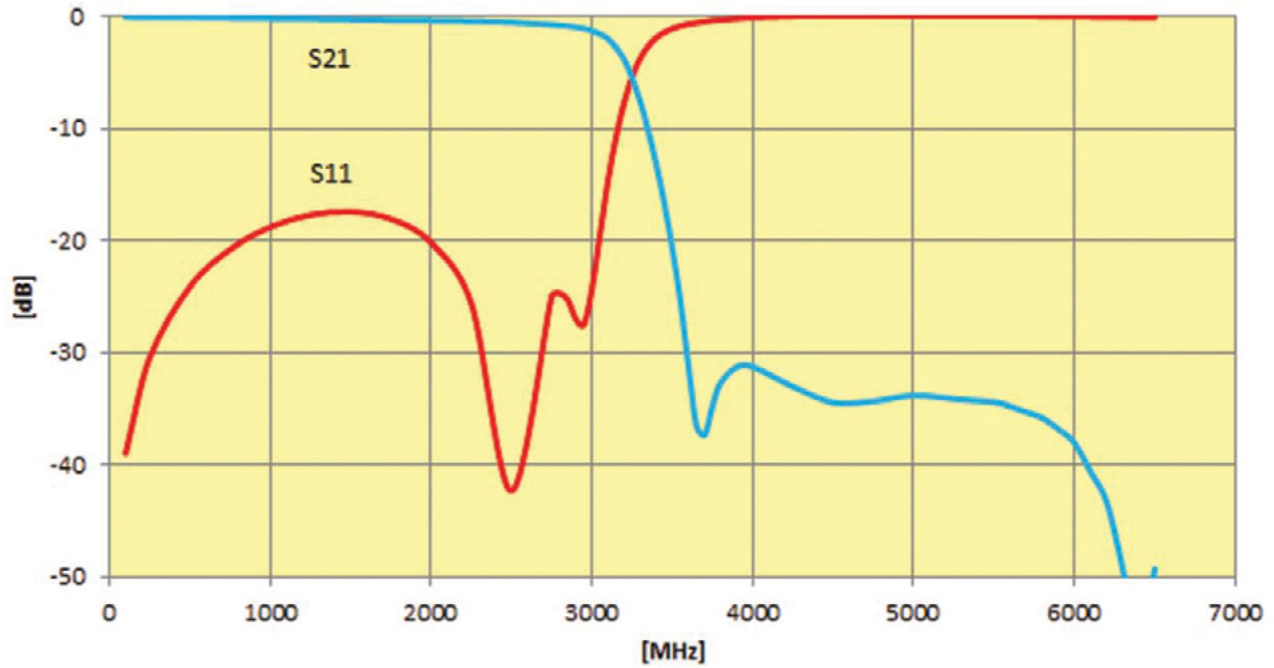

Thin-Film RF/Microwave Filters

Low Pass 0805 High Performance SMD 8W

LP0805H3500ASTR – SMD Termination

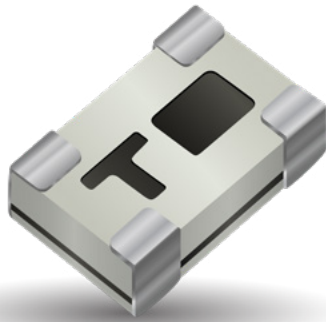

ITF TECHNOLOGY

The ITF SMD Filter is based on thin-film multilayer technology. The technology provides a miniature part with excellent high frequency performance and rugged construction for reliable automatic assembly.

The ITF Filter is offered in a variety of frequency bands compatible with various types of high frequency wireless systems.

FEATURES

- Small size: 0805
- Frequency: 3500MHz
- Characteristic impedance: 50Ω
- Operating / Storage temp: -40°C – +100°C
- Low profile
- Rugged construction
- Taped and reeled
- Power handling: 8W

APPLICATIONS

- Mobile communications
- Satellite TV receivers
- GPS
- Vehicle location systems
- Wireless LAN's

HOW TO ORDER

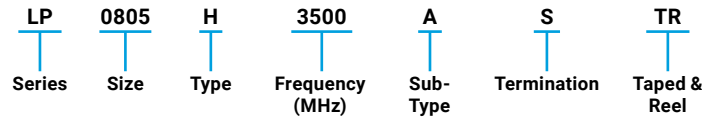

FINAL QUALITY INSPECTION

Finished parts are 100% tested for electrical parameters and visual/mechanical characteristics. Each production lot is evaluated on a sample basis for:

- Static Humidity: 85°C, 85% RH, 160 hours
- Endurance: 125°C, I_R, 4 hours

TERMINATION

Nickel/ Lead free Solder coating (Sn100) compatible with automatic soldering technologies: reflow, wave soldering, vapor phase and manual.

RECOMMENDED PAD LAYOUT:

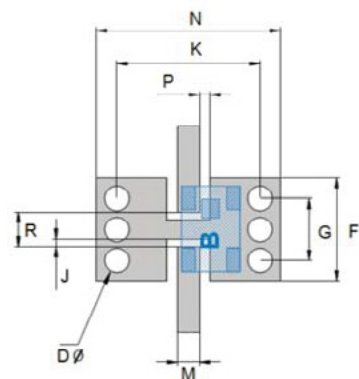

Dimension	mm (inches)
F	2.50±0.05 (0.098±0.002)
G	1.50±0.05 (0.059±0.002)
J	0.19±0.05 (0.007±0.002)
K	3.48±0.05 (0.137±0.002)
M	0.54±0.25 (0.021±0.010)
N	4.48±0.05 (0.776±0.002)
P	0.25±0.05 (0.010±0.002)
R	0.85±0.05 (0.033±0.002)
D	0.60±0.05 (0.024±0.002)

DIMENSIONS (TOP VIEW)

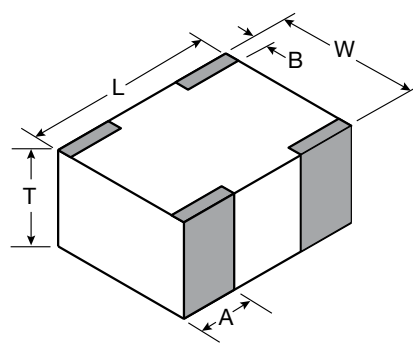

mm (inches)

Dimension	mm (inches)
L	2.03±0.10 (0.080±0.004)
W	1.55±0.10 (0.061±0.004)
T	0.80±0.10 (0.031±0.004)
A	0.56±0.25 (0.022±0.010)
B	0.35±0.15 (0.014±0.006)

TERMINAL AND LAYOUT (TOP VIEW)

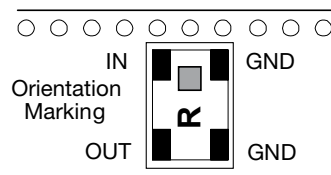

Thin-Film RF/Microwave Filters

Low Pass 0805 High Performance SMD 8W

LP0805H3500ASTR – SMD Termination



ELECTRICAL CHARACTERISTICS

P/N	Frequency	I.Loss @3500MHz	R.Loss @3500MHz	Attenuation
LP0805H3500ASTR	3500MHz	-0.85dB max.	-20dB	-35dB at 4900MHz -30dB at 7000MHz -30dB at 10500MHz

TYPICAL ELECTRICAL PERFORMANCE

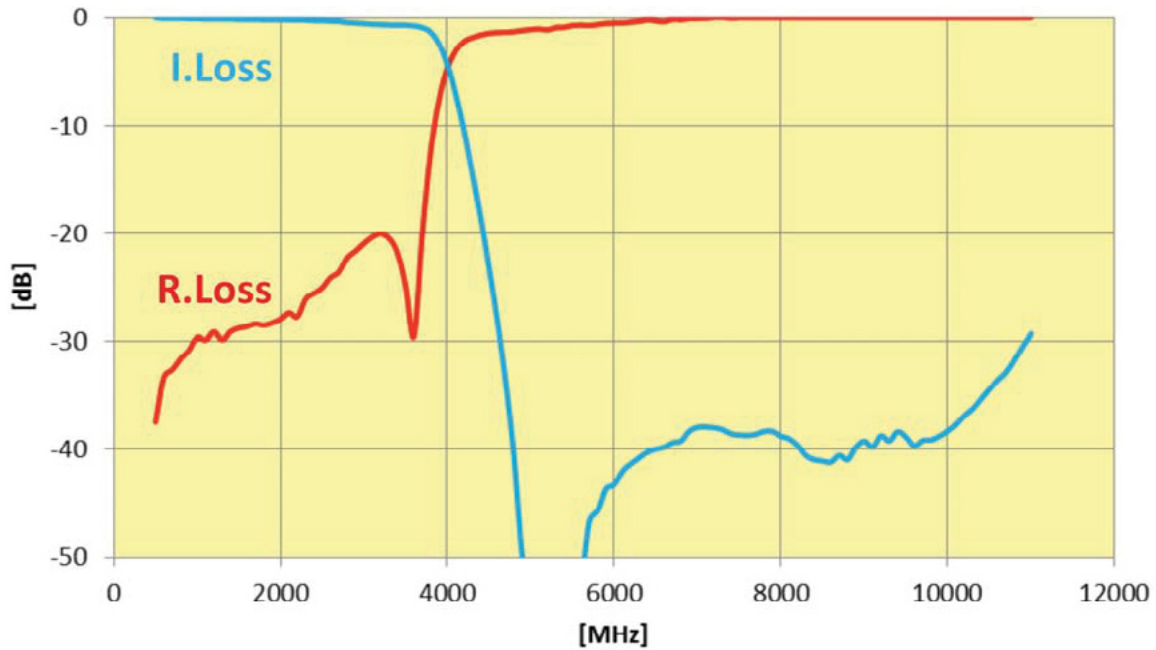

Thin-Film RF/Microwave Filters

Low Pass 0805 High Performance SMD 8W

LP0805H4000ASTR – SMD Termination



ITF TECHNOLOGY

The ITF SMD Filter is based on thin-film multilayer technology. The technology provides a miniature part with excellent high frequency performance and rugged construction for reliable automatic assembly.

The ITF Filter is offered in a variety of frequency bands compatible with various types of high frequency wireless systems.

FEATURES

- Frequency: 4000MHz
- Characteristic impedance: 50ohm
- Operating / Storage temp: -40°C – +100°C
- Low profile
- Rugged construction
- Taped and reeled
- Power handling: 8W

APPLICATIONS

- Mobile communications
- Satellite TV receivers
- GPS
- Vehicle location systems
- Wireless LAN's

HOW TO ORDER

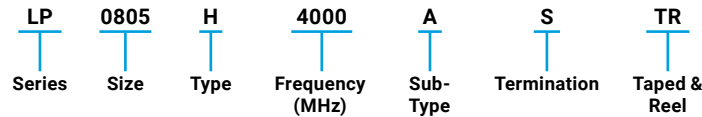

FINAL QUALITY INSPECTION

Finished parts are 100% tested for electrical parameters and visual/mechanical characteristics. Each production lot is evaluated on a sample basis for:

- Static Humidity: 85°C, 85% RH, 160 hours
- Endurance: 125°C, I_R, 4 hours

TERMINATION

Nickel/ Lead free Solder coating (Sn100) compatible with automatic soldering technologies: reflow, wave soldering, vapor phase and manual.

RECOMMENDED PAD LAYOUT:

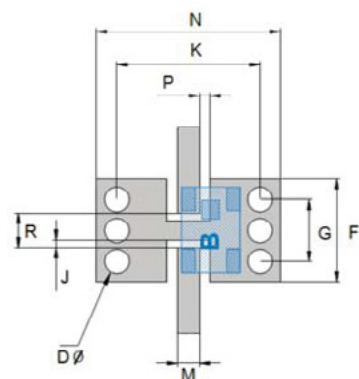

mm (inches)	
F	2.50±0.05 (0.098±0.002)
G	1.50±0.05 (0.059±0.002)
J	0.19±0.05 (0.007±0.002)
K	3.48±0.05 (0.137±0.002)
M	0.54±0.25 (0.021±0.010)
N	4.48±0.05 (0.776±0.002)
P	0.25±0.05 (0.010±0.002)
R	0.85±0.05 (0.033±0.002)
D	0.60±0.05 (0.024±0.002)

DIMENSIONS (TOP VIEW)

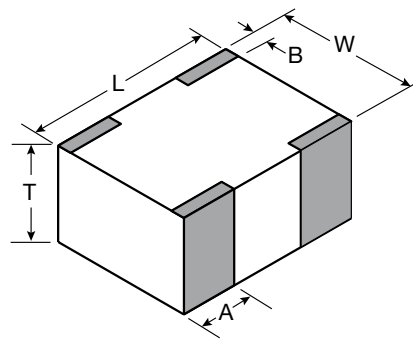

mm (inches)

L	2.03±0.10 (0.080±0.004)
W	1.55±0.10 (0.061±0.004)
T	0.80±0.10 (0.031±0.004)
A	0.56±0.25 (0.022±0.010)
B	0.35±0.15 (0.014±0.006)

TERMINAL AND LAYOUT (TOP VIEW)

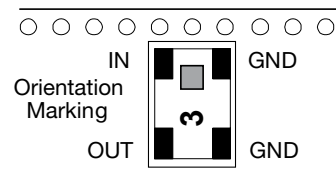

Thin-Film RF/Microwave Filters

Low Pass 0805 High Performance SMD 8W

LP0805H4000ASTR – SMD Termination



ELECTRICAL CHARACTERISTICS

P/N	Frequency	I.Loss @4000MHz	R.Loss @4000MHz	Attenuation
LP0805H4000ASTR	4000MHz	-0.8dB max.	-20dB	-40dB at 5600MHz -35dB at 8000MHz -35dB at 10000MHz -25dB at 12000MHz

TYPICAL ELECTRICAL PERFORMANCE

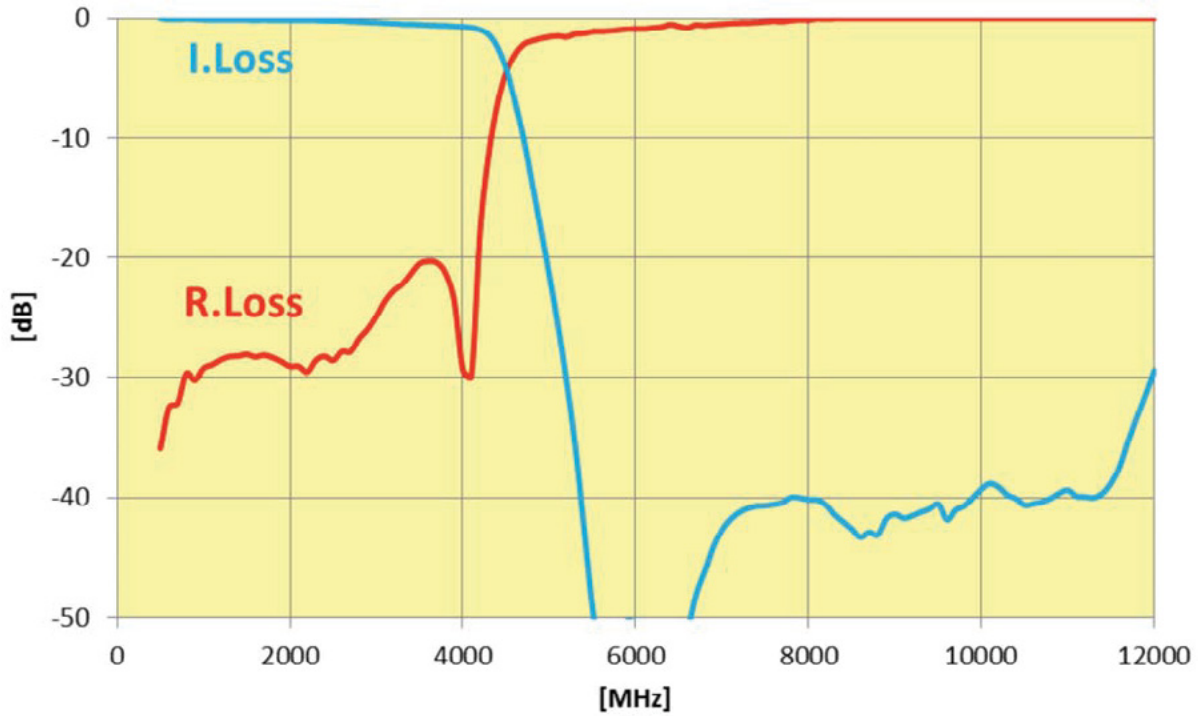

Thin-Film RF/Microwave Filters

High Performance Low Pass Filters

LP0805H5000ANTR – LGA Termination

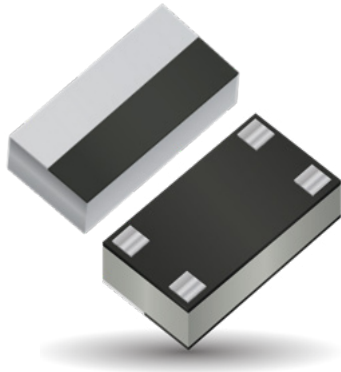

ITF TECHNOLOGY

The ITF LGA Filter is based on thin-film multilayer technology. The technology provides a miniature part with excellent high frequency performance and rugged construction for reliable automatic assembly.

The ITF Filter is offered in a variety of frequency bands compatible with various types of high frequency wireless systems.

FEATURES

- Small size: 0805
- Frequency: 5000MHz
- Characteristic impedance: 50Ω
- Operating / Storage temp: -40°C ÷ +85°C
- Low profile
- Rugged construction
- Taped and reeled
- RoHS compliant

APPLICATIONS

- WiFi
- Base Stations.
- Mobile communications
- Satellite TV receivers
- Vehicle location systems
- Wireless LAN's
- 5G Application

HOW TO ORDER

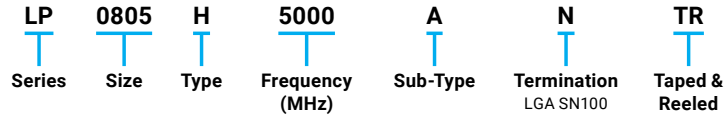

FINAL QUALITY INSPECTION

Finished parts are 100% tested for electrical parameters and visual/mechanical characteristics. Each production lot is evaluated on a sample basis for:

- Static Humidity: 85°C, 85% RH, 160 hours
- Endurance: 125°C, I_R, 4 hours

TERMINATION

Nickel/ Lead free Solder coating (Sn100) compatible with automatic soldering technologies: reflow, wave soldering, vapor phase and manual.

POWER RATING

8W Continuous

RECOMMENDED PAD LAYOUT: (mm)

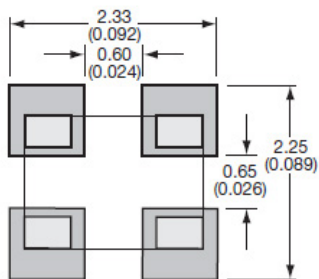

DIMENSIONS: mm (inches)

(Bottom View)

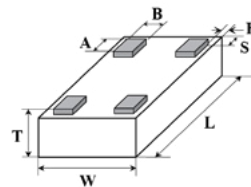

L	2.03±0.1 (0.080±0.004)
W	1.55±0.1 (0.061±0.004)
T	1.02±0.1 (0.040±0.004)

A	0.39±0.10 (0.015±0.004)
B	0.33±0.10 (0.013±0.004)
H,S	0.05±0.05 (0.002±0.002)

TERMINALS:

(Top View)

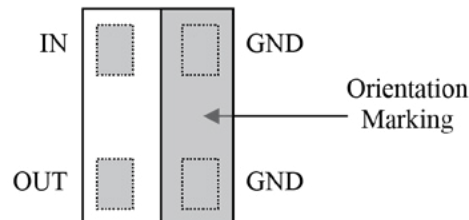

ORIENTATION IN TAPE

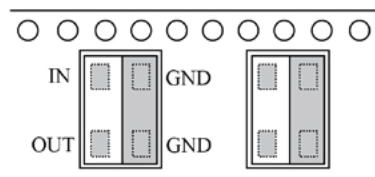

Thin-Film RF/Microwave Filters

High Performance Low Pass Filters

LP0805H5000ANTR – LGA Termination



ELECTRICAL CHARACTERISTICS

LP0805H5000ANTR			
Parameter	Value	Unit	Notes
Insertion Loss @5000 MHz	-0.5	dB	
Return Loss @5000 MHz	-12	dB	
Rejection @ 10000 MHz	-33	dB	
Rejection @ 15000 MHz	-20	dB	
Power Handling	8	W	Continuous
Impedance	50	Ohm	
Operating Temp.	-40 to +85	°C	
Size	0805		

TYPICAL ELECTRICAL PERFORMANCE

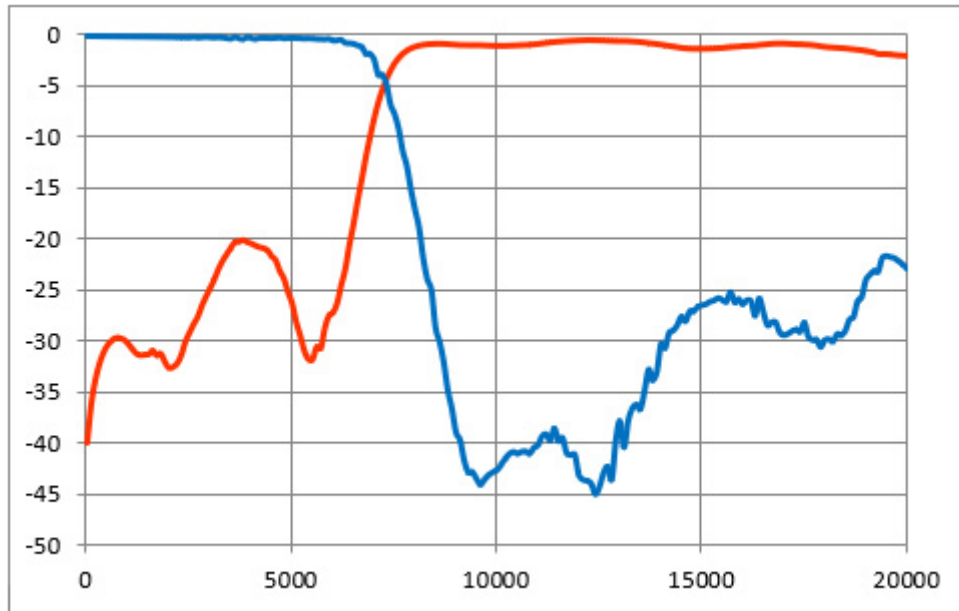

Thin-Film RF/Microwave Filters

High Performance Low Pass Filters

LP0805H5200ANTR – LGA Termination

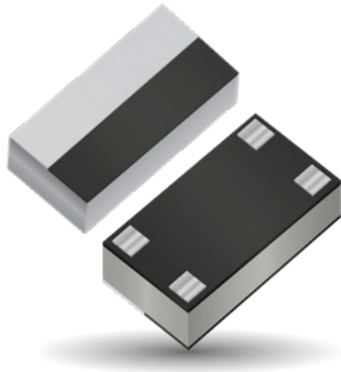

ITF TECHNOLOGY

The ITF LGA Filter is based on thin-film multilayer technology. The technology provides a miniature part with excellent high frequency performance and rugged construction for reliable automatic assembly.

The ITF Filter is offered in a variety of frequency bands compatible with various types of high frequency wireless systems.

FEATURES

- Small size: 0805
- Frequency: 5200MHz
- Characteristic impedance: 50Ω
- Operating / Storage temp: -40°C ÷ +85°C
- Low profile
- Rugged construction
- Taped and reeled
- RoHS compliant

APPLICATIONS

- WiFi
- Base Stations.
- Mobile communications
- Satellite TV receivers
- Vehicle location systems
- Wireless LAN's
- 5G Application

HOW TO ORDER

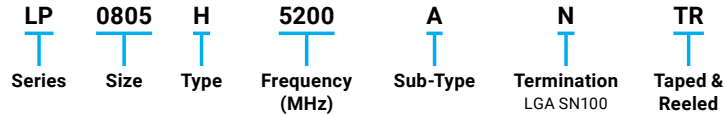

FINAL QUALITY INSPECTION

Finished parts are 100% tested for electrical parameters and visual/mechanical characteristics. Each production lot is evaluated on a sample basis for:

- Static Humidity: 85°C, 85% RH, 160 hours
- Endurance: 125°C, I_R, 4 hours

TERMINATION

Nickel/ Lead free Solder coating (Sn100) compatible with automatic soldering technologies: reflow, wave soldering, vapor phase and manual.

POWER RATING

8W Continuous

RECOMMENDED PAD LAYOUT: (mm)

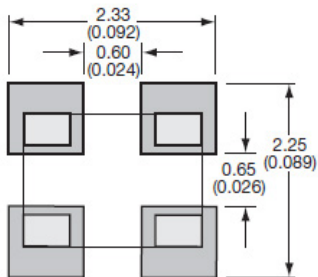

DIMENSIONS: mm (inches)

(Bottom View)

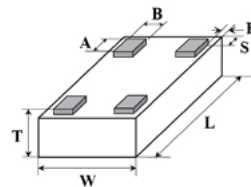

L	2.03±0.1 (0.080±0.004)
W	1.55±0.1 (0.061±0.004)
T	1.02±0.1 (0.040±0.004)

A	0.39±0.10 (0.015±0.004)
B	0.33±0.10 (0.013±0.004)
H,S	0.05±0.05 (0.002±0.002)

TERMINALS:

(Top View)

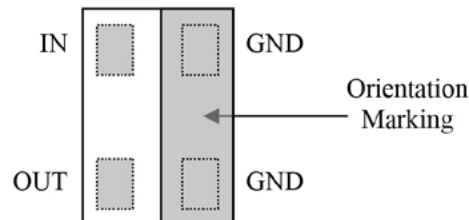

ORIENTATION IN TAPE

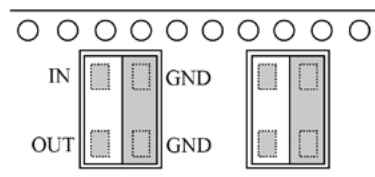

Thin-Film RF/Microwave Filters

High Performance Low Pass Filters

LP0805H5200ANTR – LGA Termination



ELECTRICAL CHARACTERISTICS

LP0805H5200ANTR			
Parameter	Value	Unit	Notes
Insertion Loss @5200 MHz	-0.5	dB	
Return Loss @5200 MHz	-12	dB	
Rejection @ 10400 MHz	-30	dB	
Rejection @ 15600 MHz	-20	dB	
Power Handling	8	W	Continuous
Impedance	50	Ohm	
Operating Temp.	-40 to +85	°C	
Size	0805		

TYPICAL ELECTRICAL PERFORMANCE

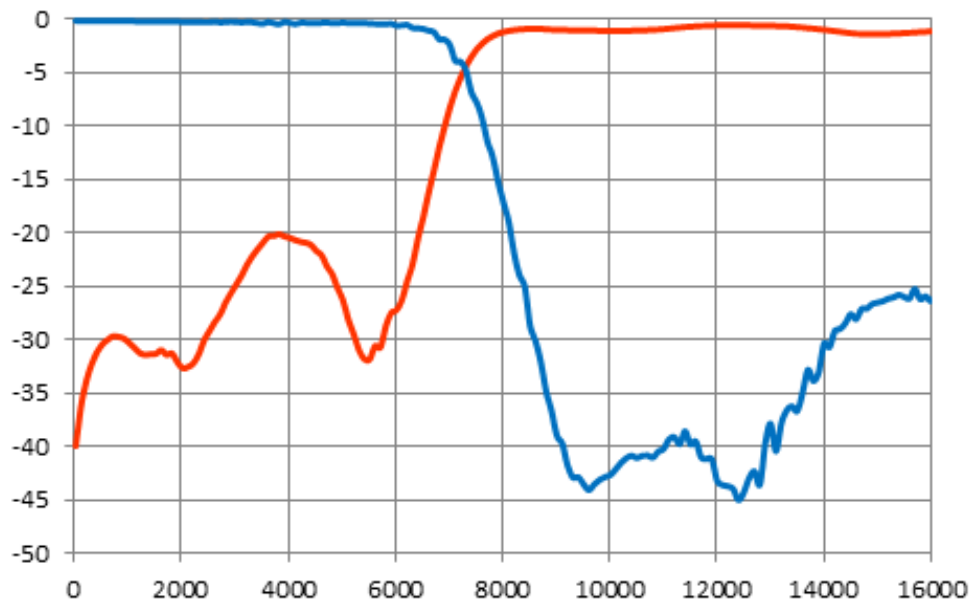

Thin-Film RF/Microwave Filters

High Performance Low Pass Filters

LP0805H5400ANTR – LGA Termination

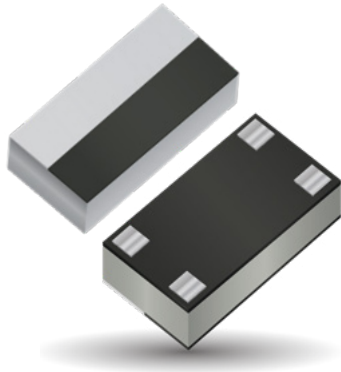

ITF TECHNOLOGY

The ITF LGA Filter is based on thin-film multilayer technology. The technology provides a miniature part with excellent high frequency performance and rugged construction for reliable automatic assembly.

The ITF Filter is offered in a variety of frequency bands compatible with various types of high frequency wireless systems.

FEATURES

- Small size: 0805
- Frequency: 5400MHz
- Characteristic impedance: 50Ω
- Operating / Storage temp: -40°C ÷ +85°C
- Low profile
- Rugged construction
- Taped and reeled
- RoHS compliant

APPLICATIONS

- WiFi
- Base Stations.
- Mobile communications
- Satellite TV receivers
- Vehicle location systems
- Wireless LAN's
- 5G Application

HOW TO ORDER

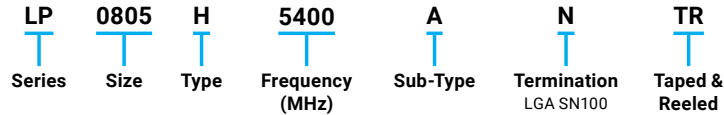

FINAL QUALITY INSPECTION

Finished parts are 100% tested for electrical parameters and visual/mechanical characteristics. Each production lot is evaluated on a sample basis for:

- Static Humidity: 85°C, 85% RH, 160 hours
- Endurance: 125°C, I_R, 4 hours

TERMINATION

Nickel/ Lead free Solder coating (Sn100) compatible with automatic soldering technologies: reflow, wave soldering, vapor phase and manual.

POWER RATING

8W Continuous

RECOMMENDED PAD LAYOUT: (mm)

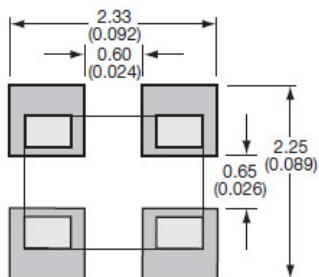

DIMENSIONS: mm (inches)

(Bottom View)

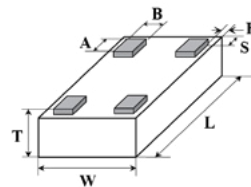

L	2.03±0.1 (0.080±0.004)
W	1.55±0.1 (0.061±0.004)
T	1.02±0.1 (0.040±0.004)

A	0.39±0.10 (0.015±0.004)
B	0.33±0.10 (0.013±0.004)
H,S	0.05±0.05 (0.002±0.002)

TERMINALS:

(Top View)

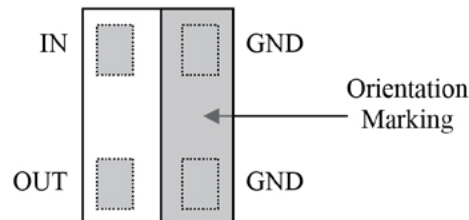

ORIENTATION IN TAPE

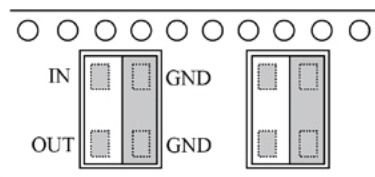

Thin-Film RF/Microwave Filters

High Performance Low Pass Filters

LP0805H5400ANTR – LGA Termination



ELECTRICAL CHARACTERISTICS

LP0805H5400ANTR			
Parameter	Value	Unit	Notes
Insertion Loss @5400 MHz	-0.7	dB	
Return Loss @5400 MHz	-12	dB	
Rejection @ 10800 MHz	-30	dB	
Rejection @ 16000 MHz	-20	dB	
Power Handling	8	W	Continuous
Impedance	50	Ohm	
Operating Temp.	-40 to +85	°C	
Size	0805		

TYPICAL ELECTRICAL PERFORMANCE

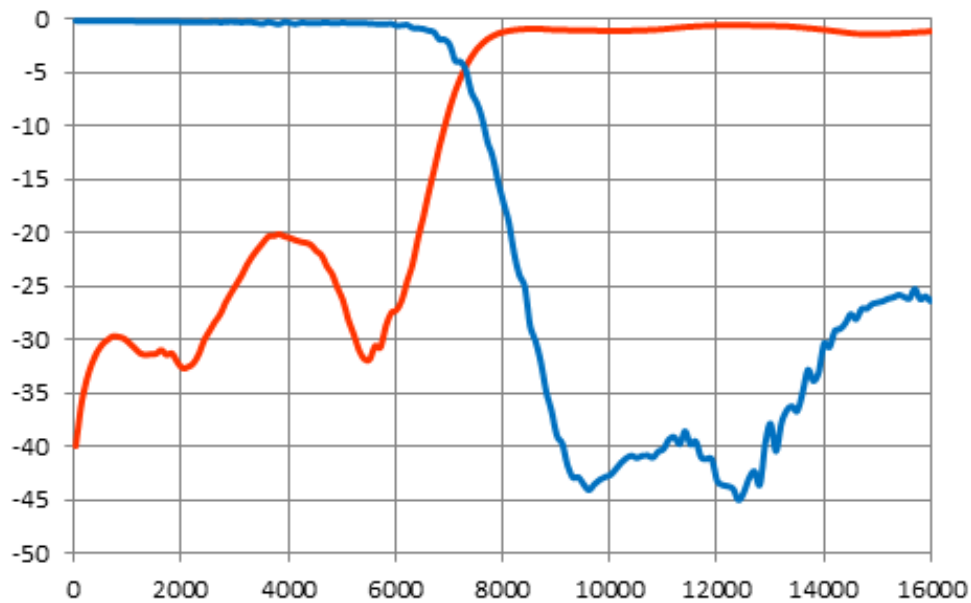

Thin-Film RF/Microwave Filters

High Performance Low Pass Filters

LP0805H5500ANTR – LGA Termination

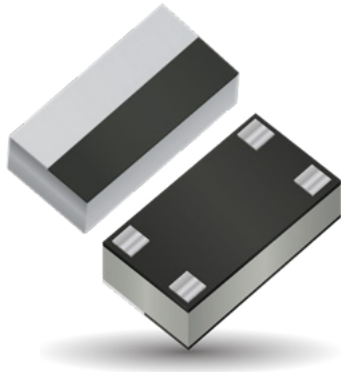

ITF TECHNOLOGY

The ITF LGA Filter is based on thin-film multilayer technology. The technology provides a miniature part with excellent high frequency performance and rugged construction for reliable automatic assembly.

The ITF Filter is offered in a variety of frequency bands compatible with various types of high frequency wireless systems.

FEATURES

- Small size: 0805
- Frequency: 5500MHz
- Characteristic impedance: 50Ω
- Operating / Storage temp: -40°C ÷ +85°C
- Low profile
- Rugged construction
- Taped and reeled
- RoHS compliant

APPLICATIONS

- WiFi
- Base Stations.
- Mobile communications
- Satellite TV receivers
- Vehicle location systems
- Wireless LAN's
- 5G Application

HOW TO ORDER

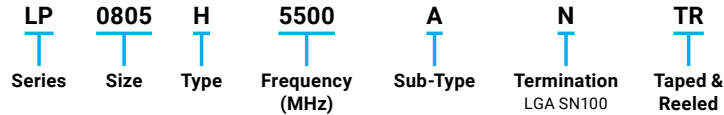

FINAL QUALITY INSPECTION

Finished parts are 100% tested for electrical parameters and visual/mechanical characteristics. Each production lot is evaluated on a sample basis for:

- Static Humidity: 85°C, 85% RH, 160 hours
- Endurance: 125°C, I_R, 4 hours

TERMINATION

Nickel/ Lead free Solder coating (Sn100) compatible with automatic soldering technologies: reflow, wave soldering, vapor phase and manual.

POWER RATING

8W Continuous

RECOMMENDED PAD LAYOUT: (mm)

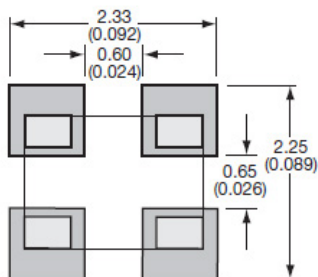

DIMENSIONS: mm (inches)

(Bottom View)

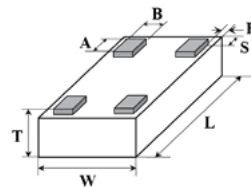

L	2.03±0.1 (0.080±0.004)
W	1.55±0.1 (0.061±0.004)
T	1.02±0.1 (0.040±0.004)

A	0.39±0.10 (0.015±0.004)
B	0.33±0.10 (0.013±0.004)
H,S	0.05±0.05 (0.002±0.002)

TERMINALS:

(Top View)

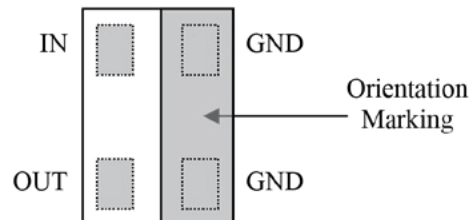

ORIENTATION IN TAPE

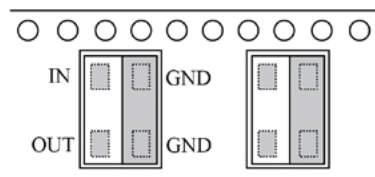

Thin-Film RF/Microwave Filters

High Performance Low Pass Filters

LP0805H5500ANTR – LGA Termination



ELECTRICAL CHARACTERISTICS

LP0805H5500ANTR			
Parameter	Value	Unit	Notes
Insertion Loss @5500 MHz	-0.6	dB	
Return Loss @5500 MHz	-12	dB	
Rejection @ 11000 MHz	-30	dB	
Rejection @ 16500 MHz	-20	dB	
Power Handling	8	W	Continuous
Impedance	50	Ohm	
Operating Temp.	-40 to +85	°C	
Size	0805		

TYPICAL ELECTRICAL PERFORMANCE

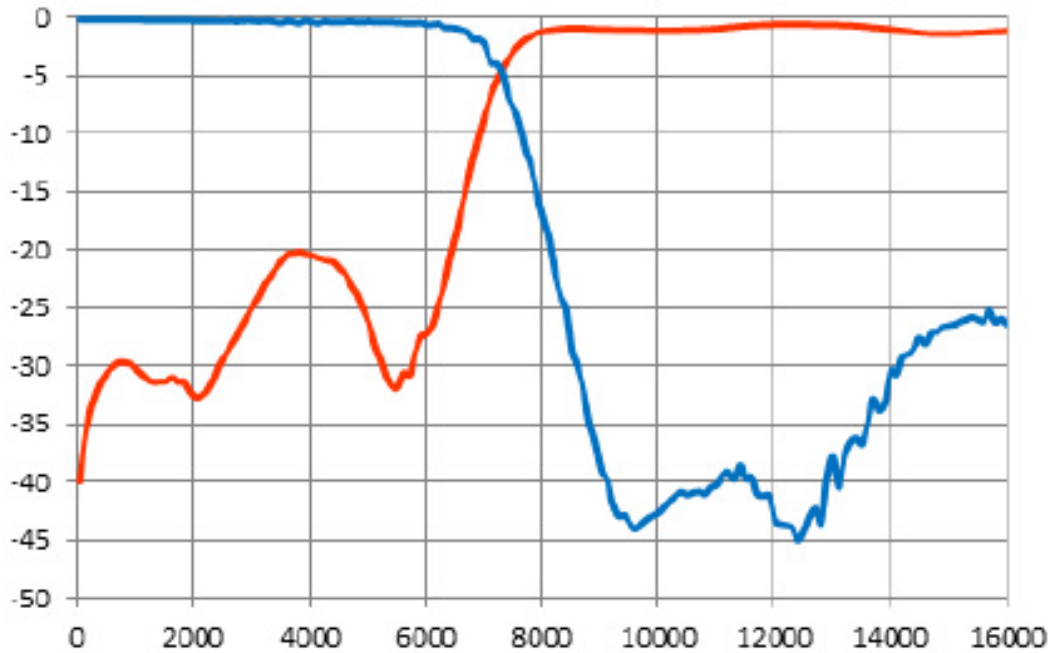

Thin-Film RF/Microwave Filters

High Performance Low Pass Filters

LP0805H5600ANTR – LGA Termination

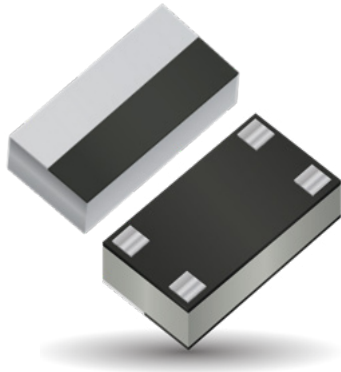

ITF TECHNOLOGY

The ITF LGA Filter is based on thin-film multilayer technology. The technology provides a miniature part with excellent high frequency performance and rugged construction for reliable automatic assembly.

The ITF Filter is offered in a variety of frequency bands compatible with various types of high frequency wireless systems.

FEATURES

- Small size: 0805
- Frequency: 5600MHz
- Characteristic impedance: 50Ω
- Operating / Storage temp: -40°C ÷ +85°C
- Low profile
- Rugged construction
- Taped and reeled
- RoHS compliant

APPLICATIONS

- WiFi
- Base Stations.
- Mobile communications
- Satellite TV receivers
- Vehicle location systems
- Wireless LAN's
- 5G Application

HOW TO ORDER

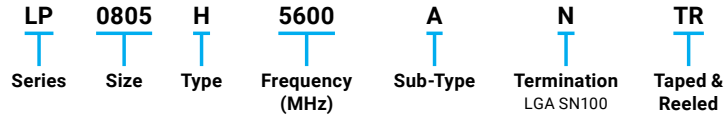

FINAL QUALITY INSPECTION

Finished parts are 100% tested for electrical parameters and visual/mechanical characteristics. Each production lot is evaluated on a sample basis for:

- Static Humidity: 85°C, 85% RH, 160 hours
- Endurance: 125°C, I_R, 4 hours

TERMINATION

Nickel/ Lead free Solder coating (Sn100) compatible with automatic soldering technologies: reflow, wave soldering, vapor phase and manual.

POWER RATING

8W Continuous

RECOMMENDED PAD LAYOUT: (mm)

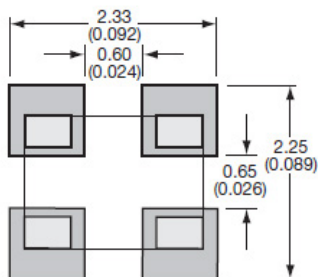

DIMENSIONS: mm (inches)

(Bottom View)

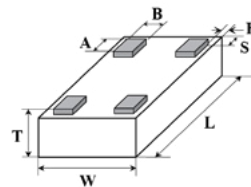

L	2.03±0.1 (0.080±0.004)
W	1.55±0.1 (0.061±0.004)
T	1.02±0.1 (0.040±0.004)

A	0.39±0.10 (0.015±0.004)
B	0.33±0.10 (0.013±0.004)
H,S	0.05±0.05 (0.002±0.002)

TERMINALS:

(Top View)

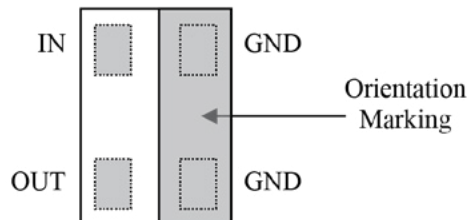

ORIENTATION IN TAPE

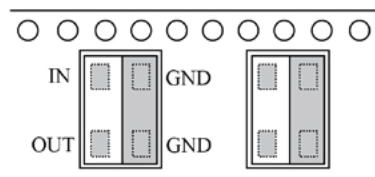

Thin-Film RF/Microwave Filters

High Performance Low Pass Filters

LP0805H5600ANTR – LGA Termination



ELECTRICAL CHARACTERISTICS

LP0805H5600ANTR			
Parameter	Value	Unit	Notes
Insertion Loss @5600 MHz	-0.6	dB	
Return Loss @5600 MHz	-12	dB	
Rejection @ 11200 MHz	-25	dB	
Rejection @ 16800 MHz	-20	dB	
Power Handling	8	W	Continuous
Impedance	50	Ohm	
Operating Temp.	-40 to +85	°C	
Size	0805		

TYPICAL ELECTRICAL PERFORMANCE

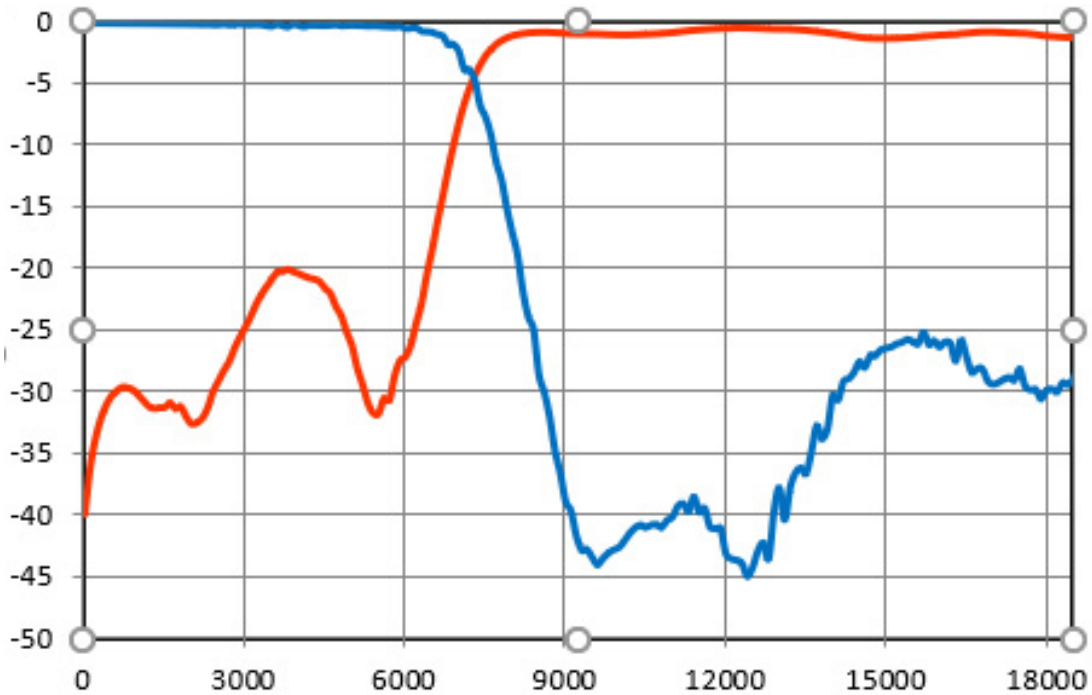

Thin-Film RF/Microwave Filters

High Performance Low Pass Filters

LP0805H5800ANTR – LGA Termination

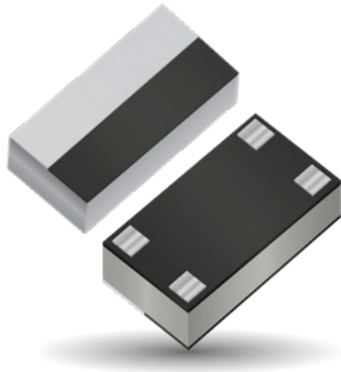

ITF TECHNOLOGY

The ITF LGA Filter is based on thin-film multilayer technology. The technology provides a miniature part with excellent high frequency performance and rugged construction for reliable automatic assembly.

The ITF Filter is offered in a variety of frequency bands compatible with various types of high frequency wireless systems.

FEATURES

- Small size: 0805
- Frequency: 5800MHz
- Characteristic impedance: 50Ω
- Operating / Storage temp: -40°C ÷ +85°C
- Low profile
- Rugged construction
- Taped and reeled
- RoHS compliant

APPLICATIONS

- WiFi
- Base Stations.
- Mobile communications
- Satellite TV receivers
- Vehicle location systems
- Wireless LAN's
- 5G Application

HOW TO ORDER

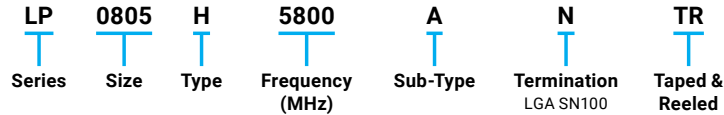

FINAL QUALITY INSPECTION

Finished parts are 100% tested for electrical parameters and visual/mechanical characteristics. Each production lot is evaluated on a sample basis for:

- Static Humidity: 85°C, 85% RH, 160 hours
- Endurance: 125°C, I_R, 4 hours

TERMINATION

Nickel/ Lead free Solder coating (Sn100) compatible with automatic soldering technologies: reflow, wave soldering, vapor phase and manual.

POWER RATING

8W Continuous

RECOMMENDED PAD LAYOUT: (mm)

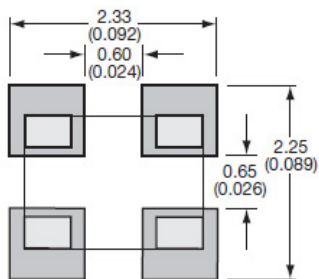

DIMENSIONS: mm (inches)

(Bottom View)

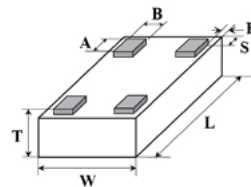

L	2.03±0.1 (0.080±0.004)
W	1.55±0.1 (0.061±0.004)
T	1.02±0.1 (0.040±0.004)

A	0.39±0.10 (0.015±0.004)
B	0.33±0.10 (0.013±0.004)
H,S	0.05±0.05 (0.002±0.002)

TERMINALS:

(Top View)

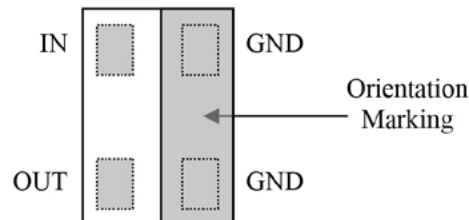

ORIENTATION IN TAPE

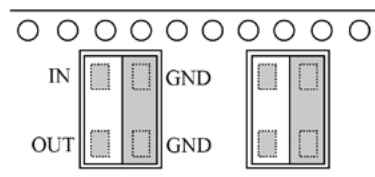

Thin-Film RF/Microwave Filters

High Performance Low Pass Filters

LP0805H5800ANTR – LGA Termination



ELECTRICAL CHARACTERISTICS

LP0805H5800ANTR			
Parameter	Value	Unit	Notes
Insertion Loss @5800 MHz	-0.7	dB	
Return Loss @5800 MHz	-12	dB	
Rejection @ 11600 MHz	-28	dB	
Rejection @ 17400 MHz	-20	dB	
Power Handling	8	W	Continuous
Impedance	50	Ohm	
Operating Temp.	-40 to +85	°C	
Size	0805		

TYPICAL ELECTRICAL PERFORMANCE

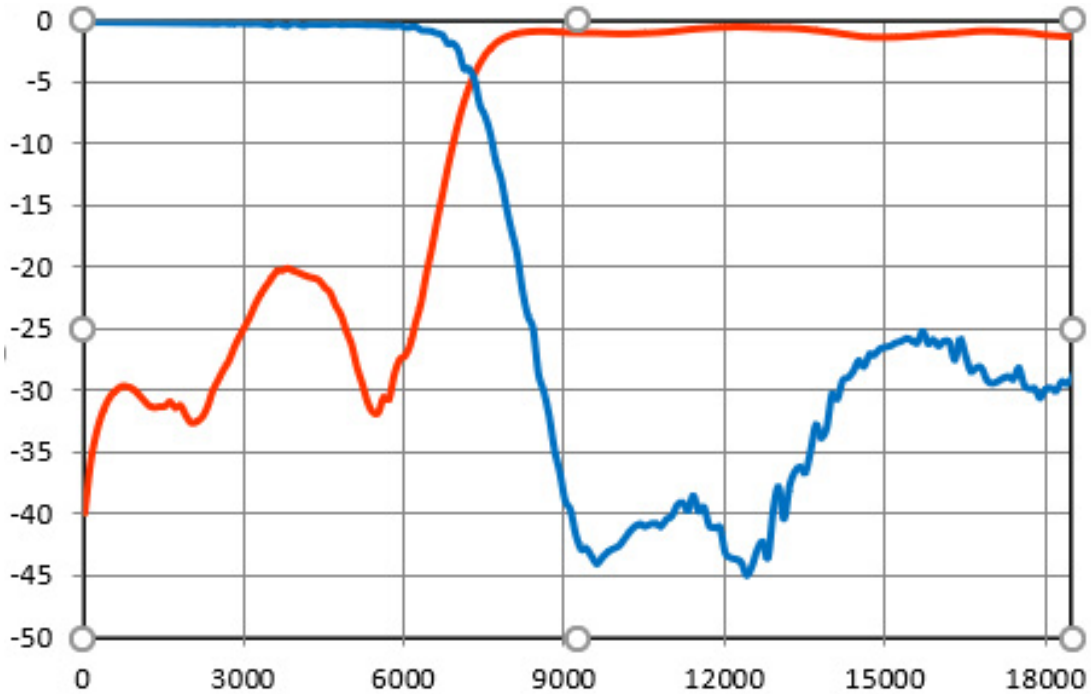

Thin-Film RF/Microwave Filters

High Performance Low Pass Filters

LP0805H6000ANTR – LGA Termination

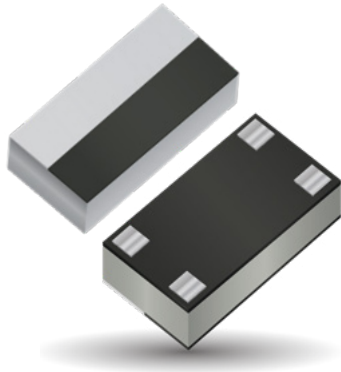

ITF TECHNOLOGY

The ITF LGA Filter is based on thin-film multilayer technology. The technology provides a miniature part with excellent high frequency performance and rugged construction for reliable automatic assembly.

The ITF Filter is offered in a variety of frequency bands compatible with various types of high frequency wireless systems.

FEATURES

- Small size: 0805
- Frequency: 6000MHz
- Characteristic impedance: 50Ω
- Operating / Storage temp: -40°C ÷ +85°C
- Low profile
- Rugged construction
- Taped and reeled
- RoHS compliant

APPLICATIONS

- WiFi
- Base Stations.
- Mobile communications
- Satellite TV receivers
- Vehicle location systems
- Wireless LAN's
- 5G Application

HOW TO ORDER

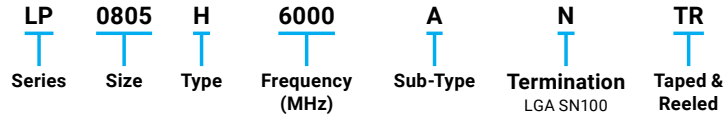

FINAL QUALITY INSPECTION

Finished parts are 100% tested for electrical parameters and visual/mechanical characteristics. Each production lot is evaluated on a sample basis for:

- Static Humidity: 85°C, 85% RH, 160 hours
- Endurance: 125°C, I_R, 4 hours

TERMINATION

Nickel/ Lead free Solder coating (Sn100) compatible with automatic soldering technologies: reflow, wave soldering, vapor phase and manual.

POWER RATING

8W Continuous

RECOMMENDED PAD LAYOUT: (mm)

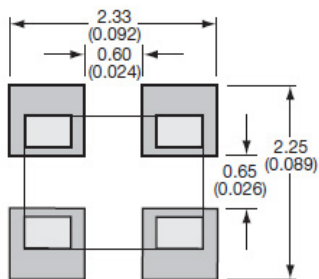

DIMENSIONS: mm (inches)

(Bottom View)

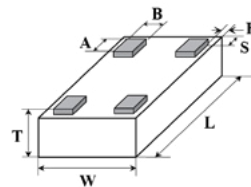

L	2.03±0.1 (0.080±0.004)
W	1.55±0.1 (0.061±0.004)
T	1.02±0.1 (0.040±0.004)

A	0.39±0.10 (0.015±0.004)
B	0.33±0.10 (0.013±0.004)
H,S	0.05±0.05 (0.002±0.002)

TERMINALS:

(Top View)

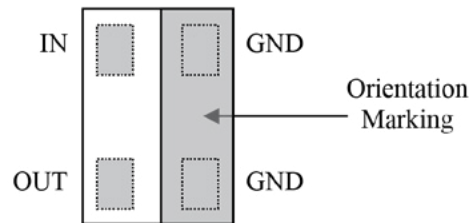

ORIENTATION IN TAPE

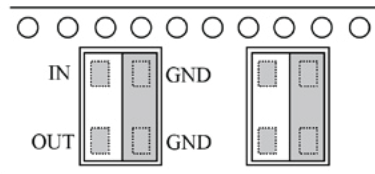

Thin-Film RF/Microwave Filters

High Performance Low Pass Filters

LP0805H6000ANTR – LGA Termination



ELECTRICAL CHARACTERISTICS

LP0805H6000ANTR			
Parameter	Value	Unit	Notes
Insertion Loss @6000 MHz	-0.7	dB	
Return Loss @6000 MHz	-12	dB	
Rejection @ 12000 MHZ	-30	dB	
Rejection @ 18000 MHz	-20	dB	
Power Handling	8	W	Continuous
Impedance	50	Ohm	
Operating Temp.	-40 to +85	°C	
Size	0805		

TYPICAL ELECTRICAL PERFORMANCE

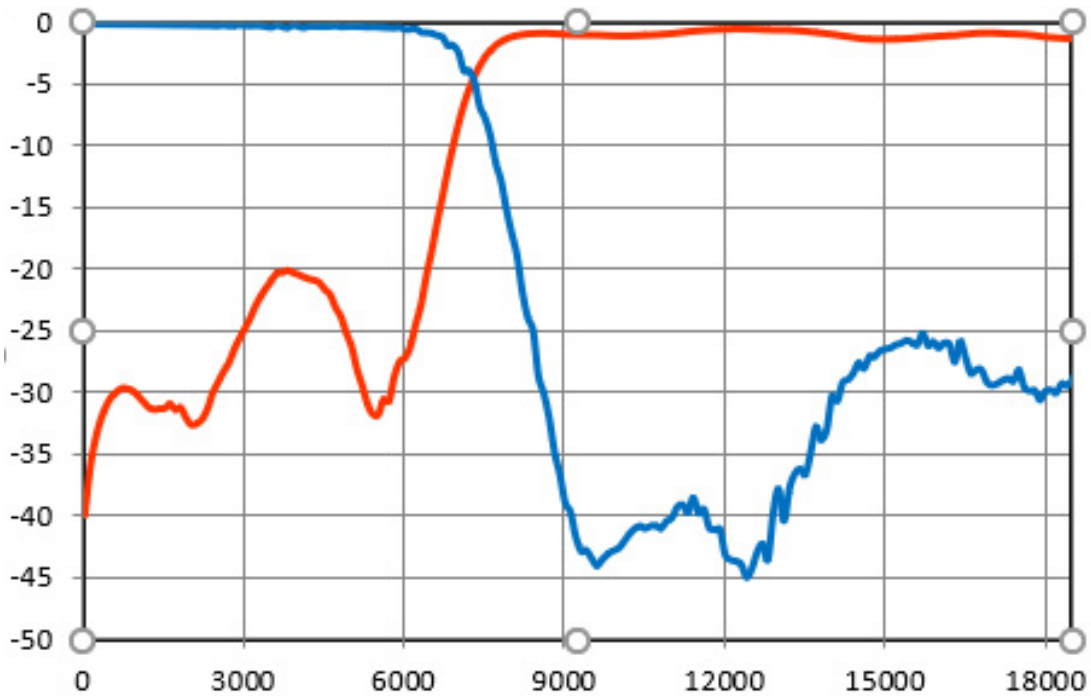



High Performance Low Pass Filters

1206 High Performance Low Pass 12W

Thin-Film RF/Microwave Filters

1206 Harmonic Low Pass Filter

LP1206A0480ANTR – LGA Termination

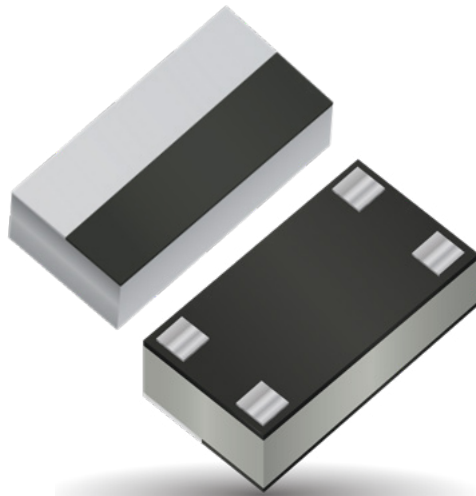

HOW TO ORDER

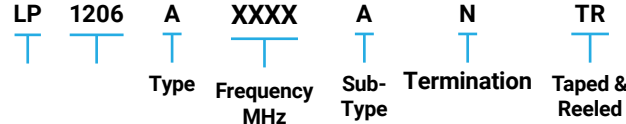

FINAL QUALITY INSPECTION

Finished parts are 100% tested for electrical parameters and visual/mechanical characteristics. Each production lot is evaluated on a sample basis for:

- Static Humidity: 85°C, 85% RH, 160 hours
- Endurance: 125°C, I_R , 4 hours

TERMINATION

Nickel/ Lead free Solder coating (Sn100) compatible with automatic soldering technologies: reflow, wave soldering, vapor phase and manual.

POWER RATING

3W Continuous

ORIENTATION IN TAPE

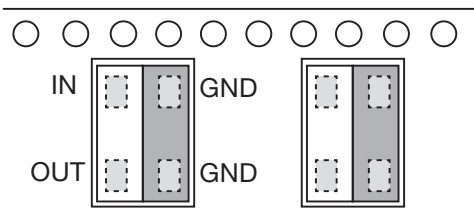

ITF TECHNOLOGY

The ITF LGA Filter is based on thin-film multilayer technology. The technology provides a miniature part with excellent high frequency performance and rugged construction for reliable automatic assembly.

The ITF Filter is offered in a variety of frequency bands compatible with various types of high frequency wireless systems.

FEATURES

- Small size: 1206
- Frequency: 480MHz
- Characteristic impedance: 50Ω
- Operating/Storage temp: -40°C to +85°C
- Low profile
- Rugged construction
- Taped and reeled
- RoHS compliant

APPLICATIONS

- Mobile communications
- Satellite TV receivers
- GPS
- Vehicle location systems
- Wireless LAN's

DIMENSIONS (BOTTOM VIEW)

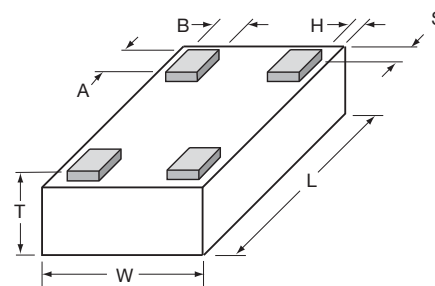

mm (inches)

L	3.10±0.10 (0.122±0.004)
W	1.60±0.10 (0.063±0.004)
T	0.60±0.30 (0.024±0.012)
A	0.39±0.10 0.015±0.004
B	0.33±0.10 0.013±0.004
H, S	0.05±0.05 (0.002±0.002)



TERMINALS (TOP VIEW)

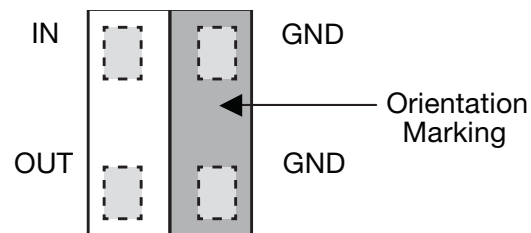

RECOMMENDED PAD LAYOUT DIMENSIONS: mm (inches)

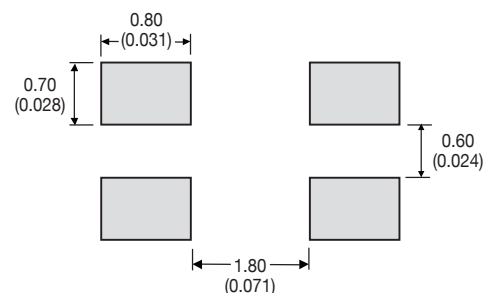

Thin-Film RF/Microwave Filters

1206 Harmonic Low Pass Filter

LP1206A0480ANTR – LGA Termination



TERMINALS (TOP VIEW)

Parameter	Value	Unit	Notes
Fc	480	MHz	
Rejection @ 700-2500MHz	-35	dB	
Insertion Loss	-1.1	dB	Max.
VSWR	1.5:1		Max. (all ports)
Power Handling	3	W	Avg.
Impedance	50	Ohm	
Operating Temp.	-40 to +85	°C	
Size	1206		

TYPICAL ELECTRICAL PERFORMANCE

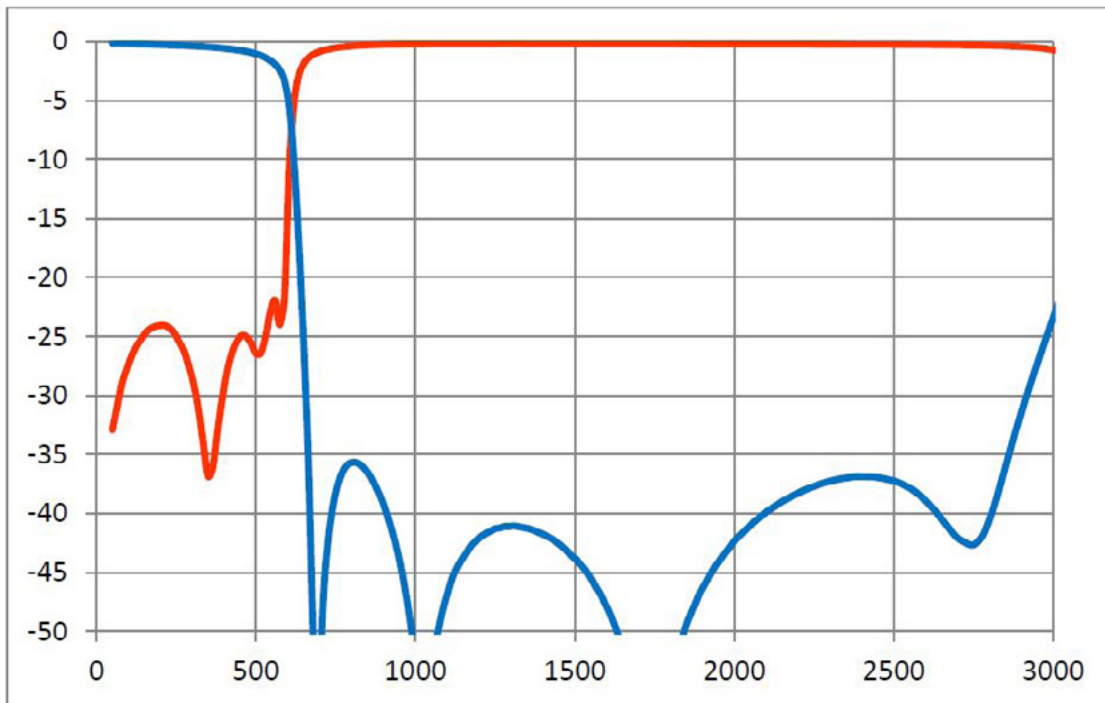

Thin-Film RF/Microwave Filters

1206 High Performance Low Pass 12W

General Information

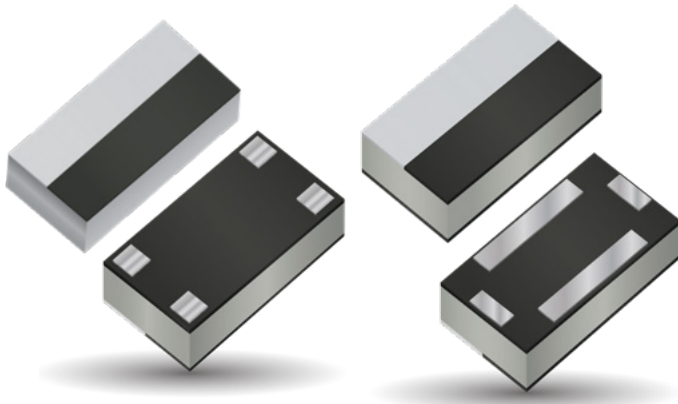

ITF TECHNOLOGY

The ITF LGA Filter is based on thin-film multilayer technology. The technology provides a miniature part with excellent high frequency performance and rugged construction for reliable automatic assembly.

The ITF Filter is offered in a variety of frequency bands compatible with various types of high frequency wireless systems.

FEATURES

- Small size: 1206
- Frequency: 500-6000MHz
- Characteristic impedance: 50Ω
- Operating/Storage temp: -40°C to +85°C
- Low profile
- Rugged construction
- Taped and reeled
- RoHS compliant

APPLICATIONS

- Base Station
- 5G & 6G / UWB
- Mobile communications
- Satellite TV receivers
- GPS
- Vehicle location systems
- Wireless LAN's

HOW TO ORDER

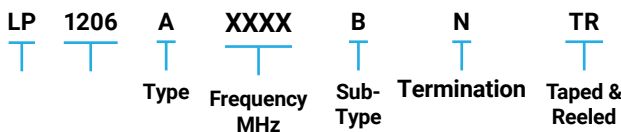

FINAL QUALITY INSPECTION

Finished parts are 100% tested for electrical parameters and visual/mechanical characteristics. Each production lot is evaluated on a sample basis for:

- Static Humidity: 85°C, 85% RH, 160 hours
- Endurance: 125°C, I_p, 4 hours



TERMINATION

Nickel/ Lead free Solder coating (Sn100) compatible with automatic soldering technologies: reflow, wave soldering, vapor phase and manual.

ELECTRICAL SPECIFICATION

Part Number	Fc [MHz]	I.L [dB] @Fc	VSWR @Fc	Rejection [dB]	Rejection [dB]
LP1206A0480ANTR	480	-1.2	1 : 1.5	-35 @700 – 2500 MHz	---
LP1206A0512BNTR	512	-0.8	1 : 2.3	-35 @ 720 - 2000 MHz	----
LP1206A0512CNTR	512	-1.5	1 : 1.5	-40 @ 678	-30 @ 700 -2500 MHz
LP1206A0600ANTR	600	-0.8	1 : 1.22	-40 @ 900 – 3100 MHz	---
LP1206A0700ANTR	700	-0.9	1 : 2.3	-35 @ 900 – 2000 MHz	----
LP1206A0720ANTR	720	-1.2	1 : 1.78	-15 @ 875 MHz	-30@ 1000 - 2500
LP1206A2000ANTR	2000	-0.7	1 : 1.66	-35 @ 4000 – 8000 MHz	----
LP1206A2500ANTR	2500	-0.7	1 : 1.66	-35 @ 5000 – 10000 MHz	-30 @ 10000 – 11000 MHz
LP1206A2700ANTR	2700	-0.7	1 : 1.66	-35 @ 5400 – 10000 MHz	-30 @ 10000 – 11500 MHz
LP1206A3000ANTR	3000	-0.7	1 : 1.66	-40 @ 6000 - 9000 MHz	-30 @ 9000 – 12000 MHz
LP1206A3200ANTR	3200	-0.7	1 : 1.66	-38 @ 6400 - 10000 MHz	-30 @ 10000 – 12800 MHz
LP1206A3300ANTR	3300	-0.7	1 : 1.66	-35 @ 6600 - 10000 MHz	-28 @ 10000 – 15000 MHz
LP1206A3500ANTR	3500	-0.7	1 : 1.66	-36 @ 6000 - 10500 MHz	-27 @ 10500 – 15000 MHz
LP1206A5000ANTR	5000	-0.7	1 : 1.43	-35 @ 9000 - 14000 MHz	-25 @ 14000 – 20000 MHz
LP1206A5200ANTR	5200	-0.7	1 : 1.43	-35 @ 9000 - 14000 MHz	-25 @ 14000 – 20000 MHz
LP1206A5500ANTR	5500	-0.7	1 : 1.43	-30 @ 9000 - 14000 MHz	-25 @ 14000 – 20000 MHz
LP1206A6000ANTR	6000	-0.6	1 : 1.22	-35 @ 8400 - 18000 MHz	---

Click on part number to see full specifications

Thin-Film RF/Microwave Filters

1206 High Performance Low Pass 12W

LP1206A0480ANTR – LGA Termination

TYPICAL ELECTRICAL PERFORMANCE

Parameter	Value	Unit	Notes
Fc	480	MHz	
Insertion Loss	-1.2	dB	Max.
VSWR	1.5: 1		Max. (all ports)
Rejection	-35	dB	Min. (700MHz to 2.5GHz)
Power Handling	3	W	Continuous
Impedance	50	Ohm	
Operating Temp.	-40 to +85	°C	
Size	1206		

[Click here to return to main table.](#)

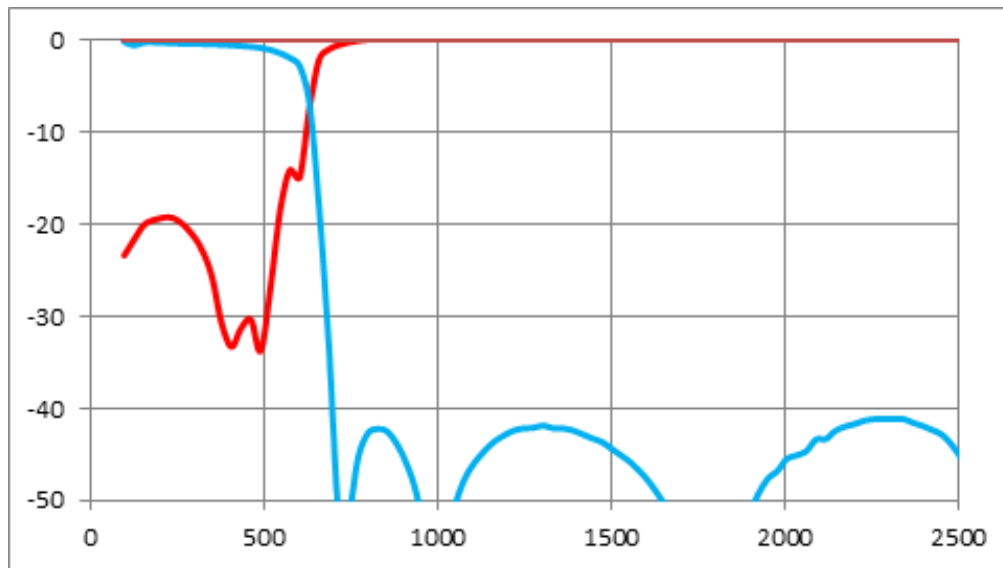

DIMENSIONS (BOTTOM VIEW)

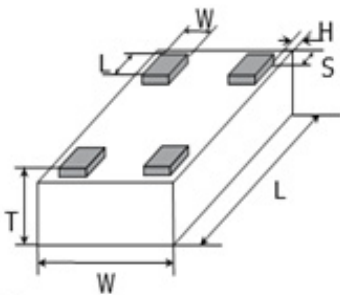

mm (inches)

L	3.10±0.10 (0.122±0.004)
W	1.60±0.10 (0.063±0.004)
T	0.60±0.30 (0.024±0.012)
A	0.39±0.10 0.015±0.004
B	0.33±0.10 0.013±0.004
H, S	0.05±0.05 (0.002±0.002)

RECOMMENDED PAD LAYOUT AND TERMINALS (TOP VIEW)

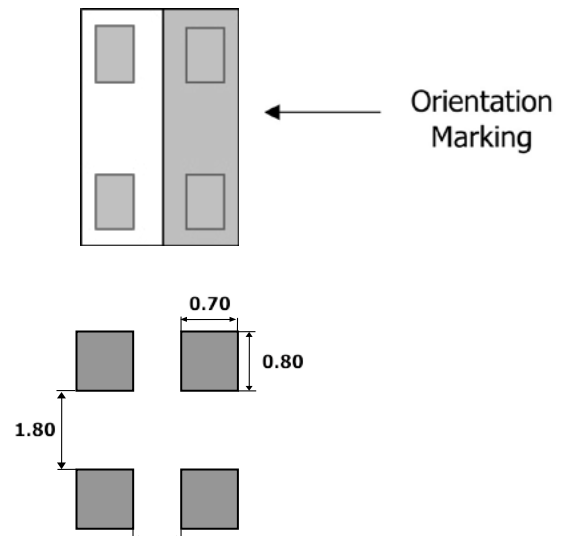

Thin-Film RF/Microwave Filters

1206 High Performance Low Pass 12W

LP1206A0512BNTR – LGA Termination



TYPICAL ELECTRICAL PERFORMANCE

Parameter	Value	Unit	Notes
Fc	512	MHz	
Insertion Loss	0.8	dB	Max.
VSWR	2.3:1		Max. (all ports)
Rejection @ 900MHz	-35	dB	Min. (720MHz to 2GHz)
Power Handling	3	W	Continuous
Impedance	50	Ohm	
Operating Temp.	-40 to +85	°C	
Size	1206		

[Click here to return to main table.](#)

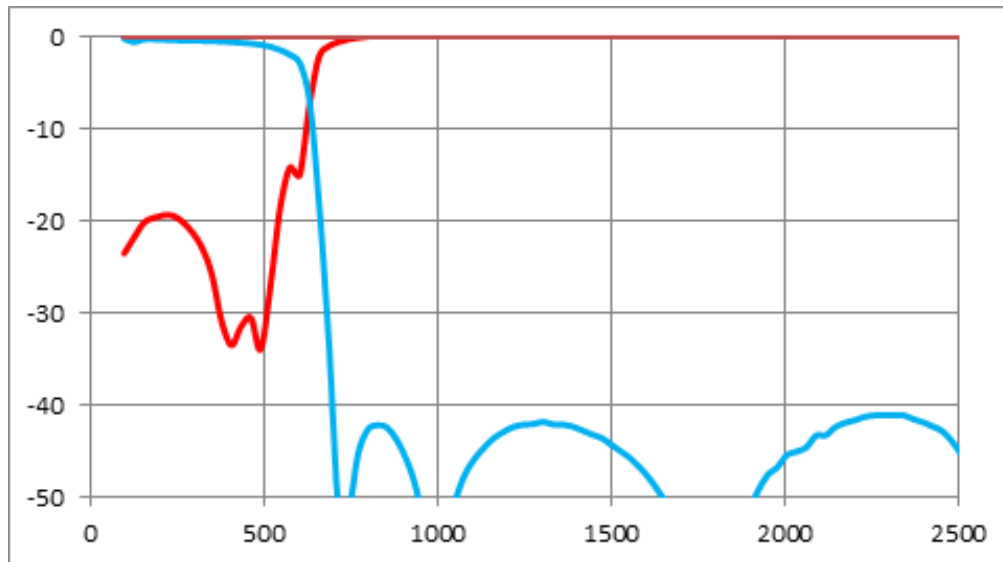

DIMENSIONS (BOTTOM VIEW)

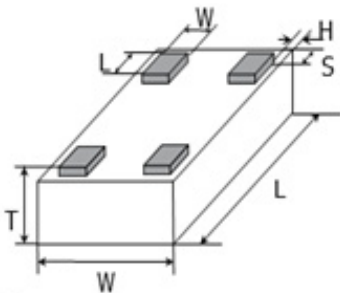

mm (inches)

L	3.10±0.10 (0.122±0.004)
W	1.60±0.10 (0.063±0.004)
T	0.60±0.30 (0.024±0.012)
A	0.39±0.10 0.015±0.004
B	0.33±0.10 0.013±0.004
H, S	0.05±0.05 (0.002±0.002)

RECOMMENDED PAD LAYOUT AND TERMINALS (TOP VIEW)

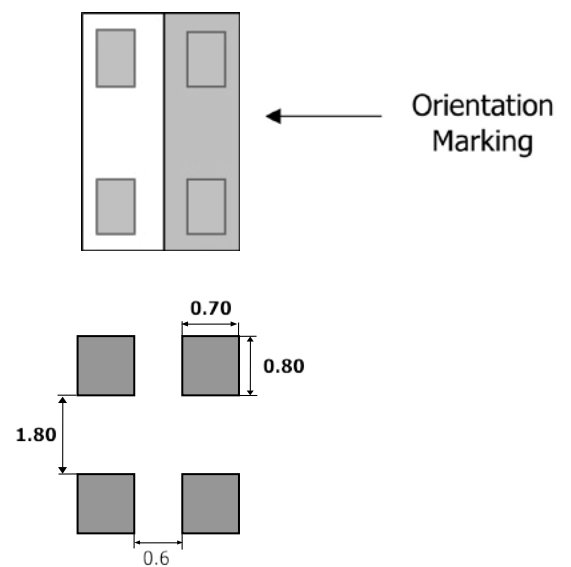

Thin-Film RF/Microwave Filters

1206 Harmonic Low Pass Filter

LP1206A0512CNTR – LGA Termination

TYPICAL ELECTRICAL PERFORMANCE

Parameter	Value	Unit	Notes
Fc	512	MHz	
Insertion Loss	-1.5	dB	Max.
VSWR	2.3:1		Max. (all ports)
Rejection @ 678MHz	-40	dB	Min.
Rejection @ 700 - 2500 MHz	-35	dB	
Power Handling	3	W	Continuous
Impedance	50	Ohm	
Operating Temp.	-40 to +85	°C	
Size	1206		

[Click here to return to main table.](#)

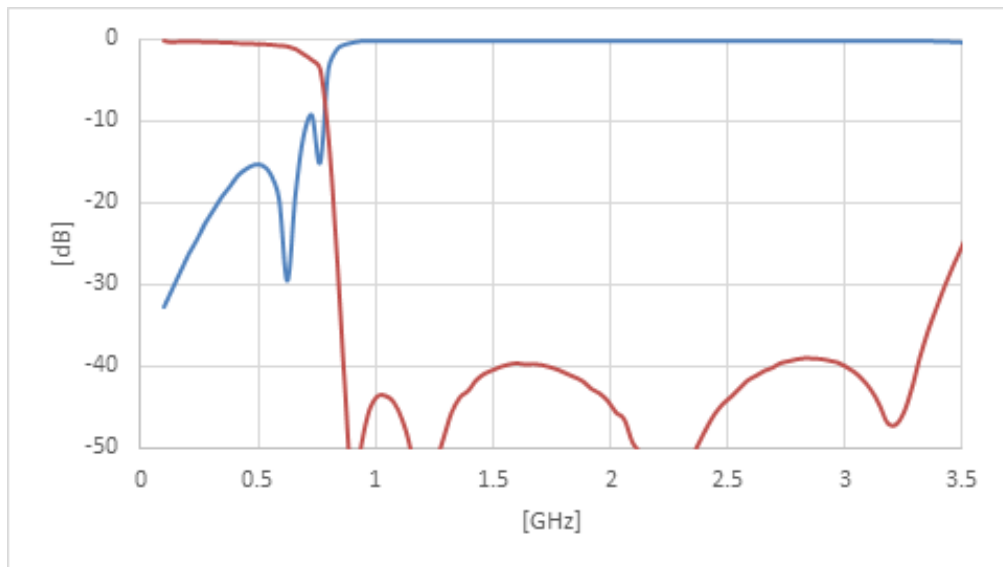

DIMENSIONS (BOTTOM VIEW)

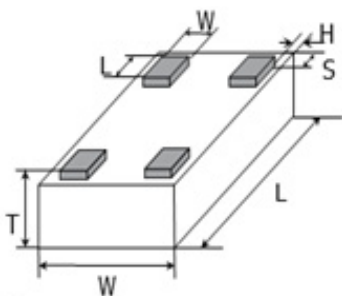

mm (inches)

L	3.10±0.10 (0.122±0.004)
W	1.60±0.10 (0.063±0.004)
T	0.60±0.30 (0.024±0.012)
A	0.39±0.10 0.015±0.004
B	0.33±0.10 0.013±0.004
H, S	0.05±0.05 (0.002±0.002)

RECOMMENDED PAD LAYOUT AND TERMINALS (TOP VIEW)

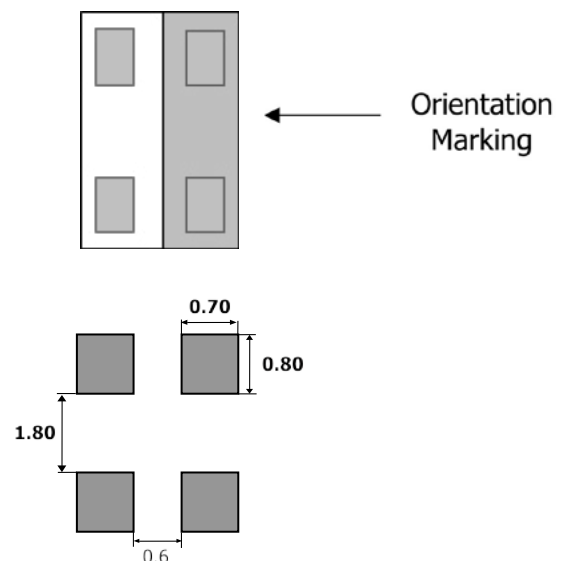

Thin-Film RF/Microwave Filters

1206 High Performance Low Pass 12W

LP1206A0600ANTR – LGA Termination



TYPICAL ELECTRICAL PERFORMANCE

Parameter	Value	Unit	Notes
Fc	600	MHz	
Insertion Loss	-0.8	dB	Max.
VSWR	1.22: 1		Max. (all ports)
Rejection	-40	dB	Typ. (900MHz to 3GHz)
Power Handling	12	W	Continuous
Impedance	50	Ohm	
Operating Temp.	-40 to +85	°C	
Size	1206		

[Click here to return to main table.](#)

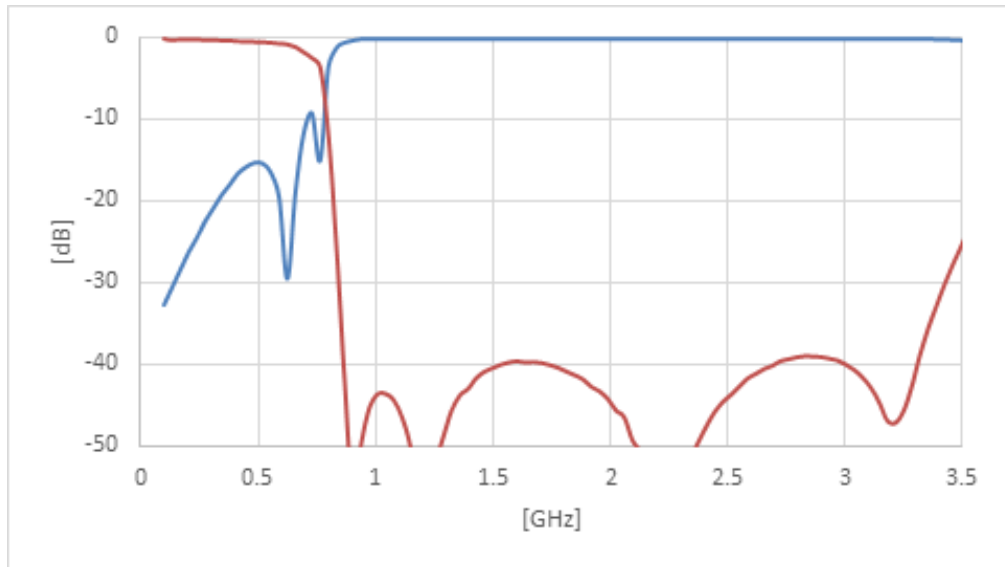

DIMENSIONS (BOTTOM VIEW)

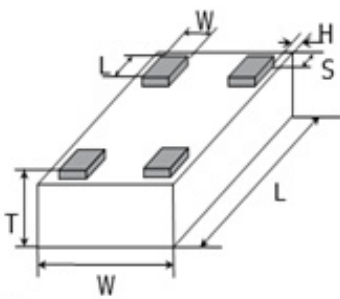

mm (inches)

L	3.10±0.10 (0.122±0.004)
W	1.60±0.10 (0.063±0.004)
T	0.60±0.30 (0.024±0.012)
A	0.39±0.10 0.015±0.004
B	0.33±0.10 0.013±0.004
H, S	0.05±0.05 (0.002±0.002)

RECOMMENDED PAD LAYOUT AND TERMINALS (TOP VIEW)

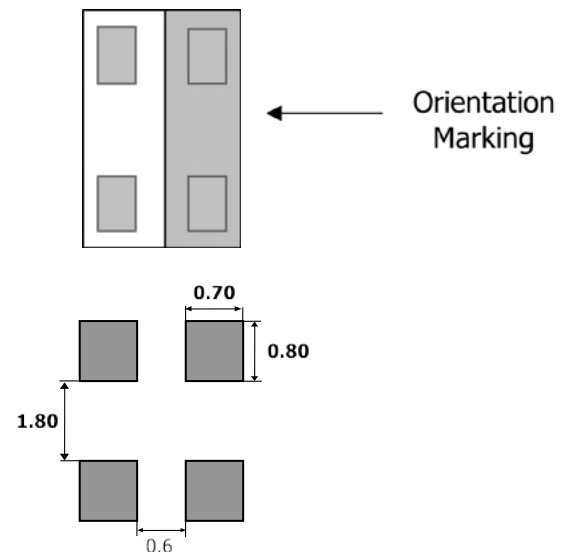

Thin-Film RF/Microwave Filters

1206 High Performance Low Pass 12W

LP1206A0700ANTR – LGA Termination



TYPICAL ELECTRICAL PERFORMANCE

Parameter	Value	Unit	Notes
Fc	700	MHz	
Rejection @ 900MHz	-35	dB	Min. (900MHz to 2GHz)
Insertion Loss	0.9	dB	Max.
VSWR	2.3: 1		Max. (all ports)
Power Handling	3	W	Continuous
Impedance	50	Ohm	
Operating Temp.	-40 to +85	°C	
Size	1206		

[Click here to return to main table.](#)

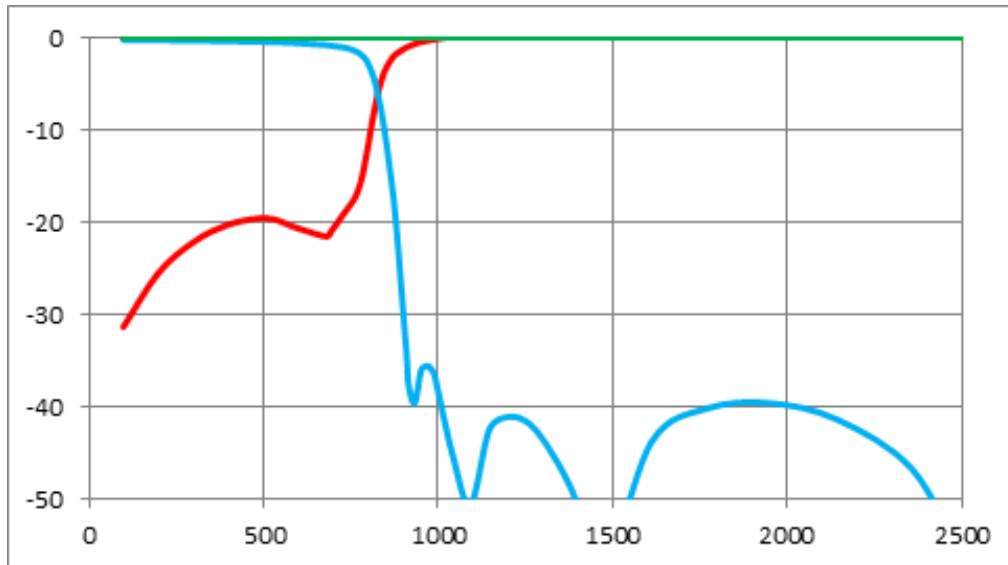

DIMENSIONS (BOTTOM VIEW)

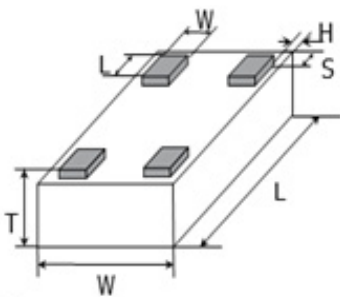

mm (inches)

L	3.10±0.10 (0.122±0.004)
W	1.60±0.10 (0.063±0.004)
T	0.60±0.30 (0.024±0.012)
A	0.39±0.10 0.015±0.004
B	0.33±0.10 0.013±0.004
H, S	0.05±0.05 (0.002±0.002)

RECOMMENDED PAD LAYOUT AND TERMINALS (TOP VIEW)

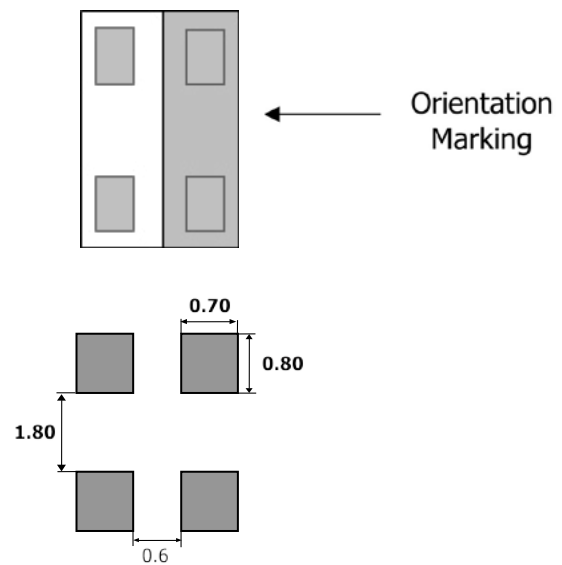

Thin-Film RF/Microwave Filters

1206 High Performance Low Pass 12W

LP1206A0720ANTR – LGA Termination



TYPICAL ELECTRICAL PERFORMANCE

Parameter	Value	Unit	Notes
Fc	720	MHz	
Insertion Loss	-1.2	dB	Max.
VSWR	1.49 : 1		Max. (all ports)
Rejection	-15	dB	Typ. (875 MHz to 2.5GHz)
Power Handling	3	W	Continuous
Impedance	50	Ohm	
Operating Temp.	-40 to +85	°C	
Size	1206		

Click here to return to main table.

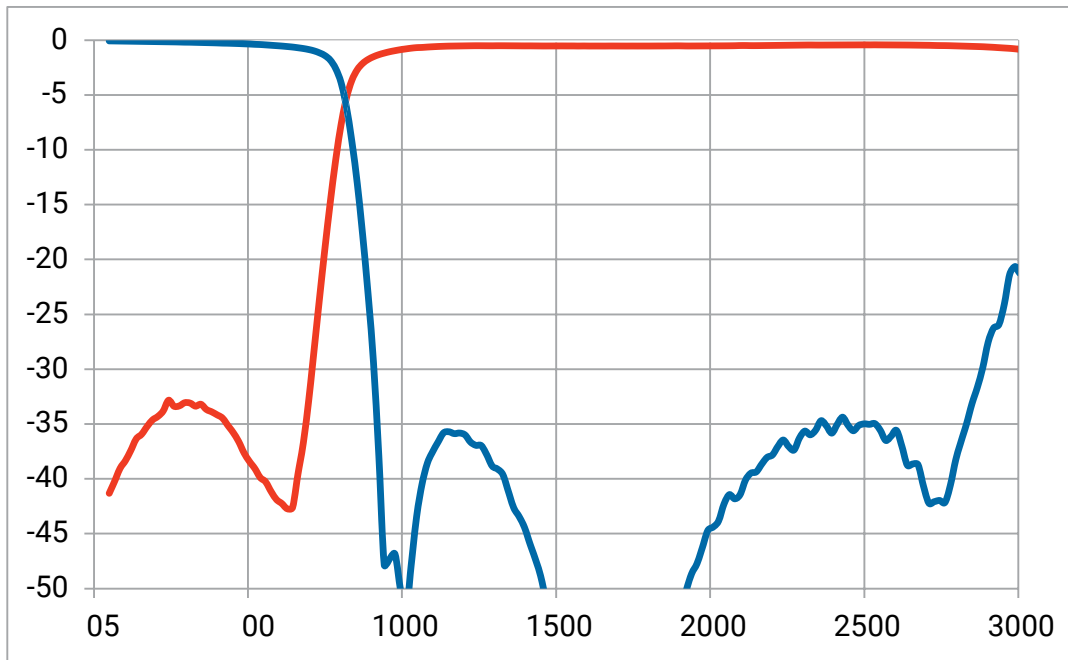

RECOMMENDED PAD LAYOUT AND TERMINALS (TOP VIEW)

DIMENSIONS (BOTTOM VIEW)

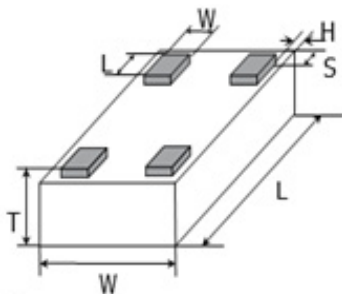

mm (inches)

L	3.10±0.10 (0.122±0.004)
W	1.60±0.10 (0.063±0.004)
T	0.60±0.30 (0.024±0.012)
A	0.39±0.10 0.015±0.004
B	0.33±0.10 0.013±0.004
H, S	0.05±0.05 (0.002±0.002)

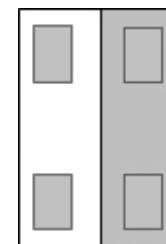

Orientation Marking

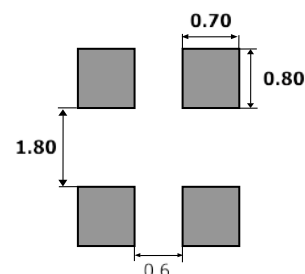

Thin-Film RF/Microwave Filters

High Performance Low Pass Filters

LP1206A2000ANTR – LGA Termination



TYPICAL ELECTRICAL PERFORMANCE

Parameter	Value	Unit	Notes
Fc	2000	MHz	
Insertion Loss	-0.7	dB	Max.
VSWR	1.49 : 1		Max. (all ports)
Rejection	-35	dB	Typ. (4.0 – 8.0 GHz)
Power Handling	1.67 : 1	W	Continuous
Impedance	50	Ohm	
Operating Temp.	-40 to +85	°C	
Size	1206		

[Click here to return to main table.](#)

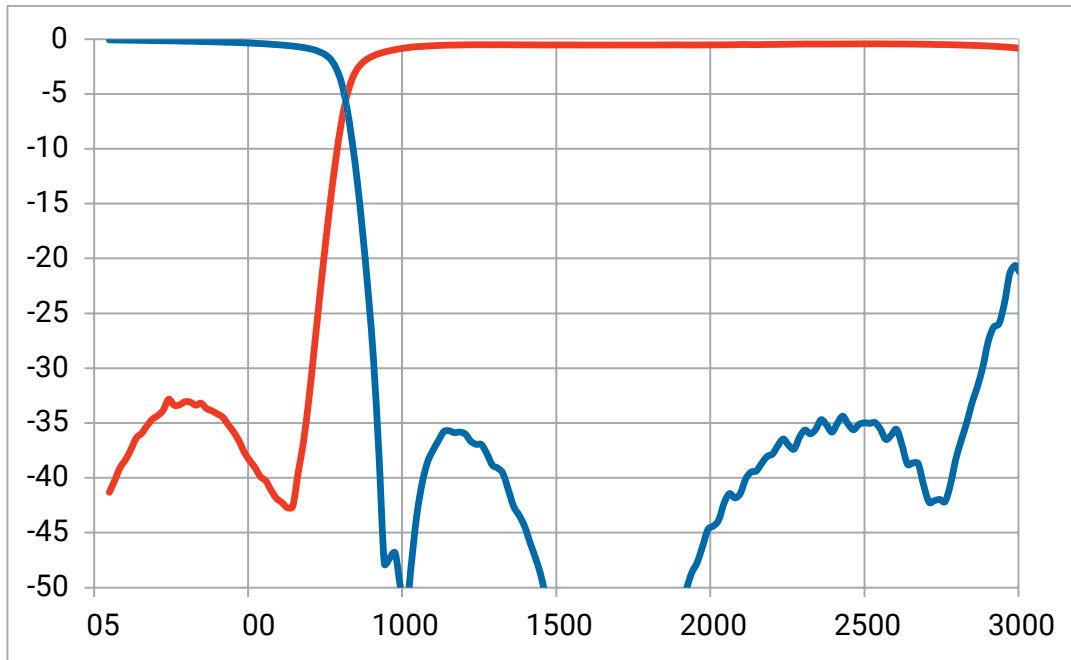

RECOMMENDED PAD LAYOUT AND TERMINALS (TOP VIEW)

DIMENSIONS (BOTTOM VIEW)

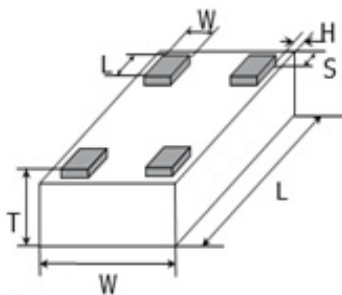

mm (inches)

L	3.10±0.10 (0.122±0.004)
W	1.60±0.10 (0.063±0.004)
T	0.60±0.30 (0.024±0.012)
A	0.39±0.10 0.015±0.004
B	0.33±0.10 0.013±0.004
H, S	0.05±0.05 (0.002±0.002)

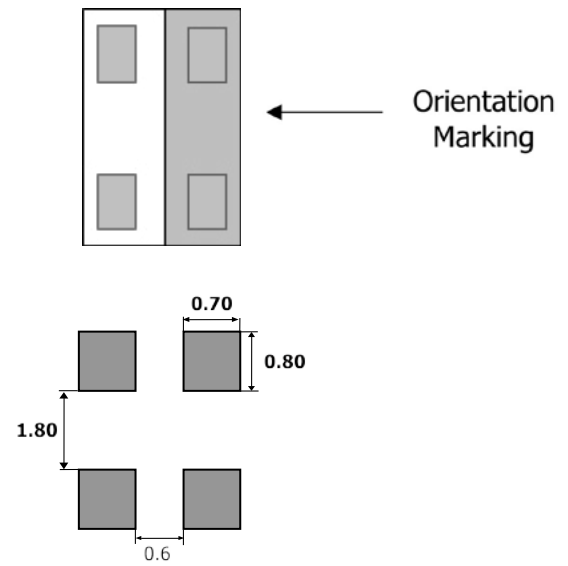

The Important Information/Disclaimer is incorporated in the catalog where these specifications came from or available online at www.kyocera-avx.com/disclaimer/ by reference and should be reviewed in full before placing any order.

071922

– RF MICROWAVE PRODUCTS –

Thin-Film RF/Microwave Filters

High Performance Low Pass Filters

LP1206A2500ANTR – LGA Termination



TYPICAL ELECTRICAL PERFORMANCE

Parameter	Value	Unit	Notes
Fc	2500	MHz	
Insertion Loss	-0.7	dB	Max.
VSWR	1.49 : 1		Max. (all ports)
Rejection	-35	dB	Typ. (5.0 – 10.0 GHz)
Power Handling	1.67 : 1	W	Continuous
Impedance	50	Ohm	
Operating Temp.	-40 to +85	°C	
Size	1206		

[Click here to return to main table.](#)

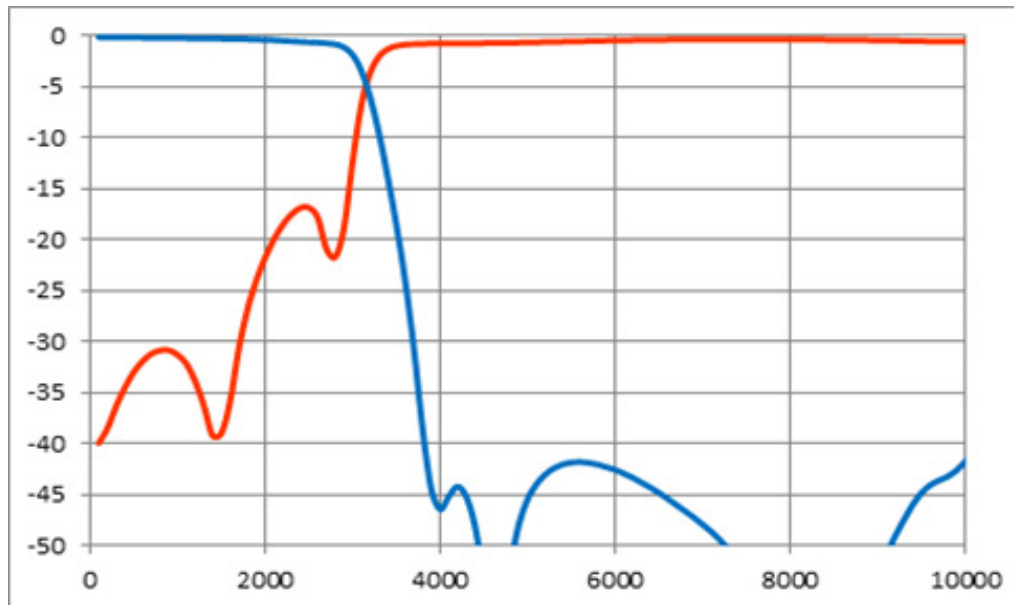

DIMENSIONS: mm (inches) (Bottom View)

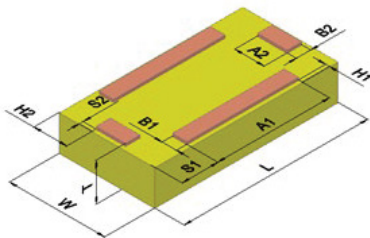

L	3.1±0.1	B1,B2	0.25±0.1
W	1.6±0.1	H1	0.06±0.06
T	0.6±0.3	H2	0.56±0.10
A1	1.9±0.1	S1	0.61±0.1
A2	0.5±0.1	S2	0.06±0.06

TERMINALS: (Top View)

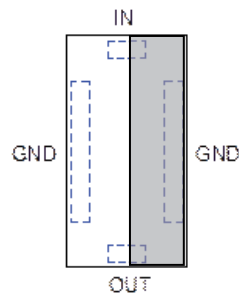

RECOMMENDED PAD LAYOUT: (mm)

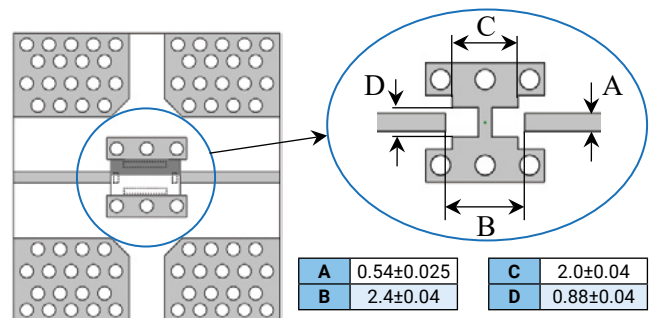

Thin-Film RF/Microwave Filters

High Performance Low Pass Filters

LP1206A2700ANTR – LGA Termination



TYPICAL ELECTRICAL PERFORMANCE

Parameter	Value	Unit	Notes
Fc	2700	MHz	
Insertion Loss	-0.85	dB	Max.
VSWR	1.49 : 1		Max. (all ports)
Rejection	-35	dB	Typ. (5.4 – 10.0 GHz)
Rejection	-30	dB	Typ. (10.0 – 11.5 GHz)
Power Handling	1.67 : 1	W	Continuous
Impedance	50	Ohm	
Operating Temp.	-40 to +85	°C	
Size	1206		

[Click here to return to main table.](#)

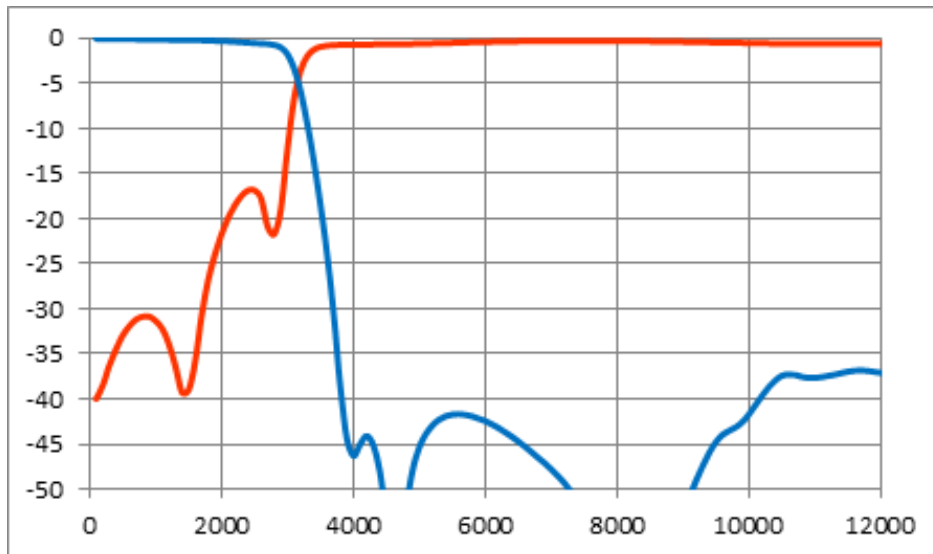

DIMENSIONS: mm (inches) (Bottom View)

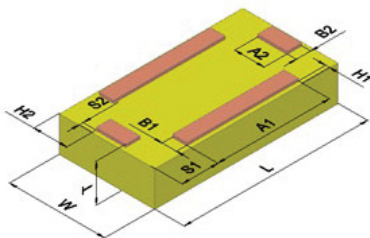

L	3.1±0.1	B1,B2	0.25±0.1
W	1.6±0.1	H1	0.06±0.06
T	0.6±0.3	H2	0.56±0.10
A1	1.9±0.1	S1	0.61±0.1
A2	0.5±0.1	S2	0.06±0.06

TERMINALS: (Top View)

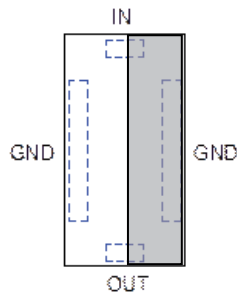

RECOMMENDED PAD LAYOUT: (mm)

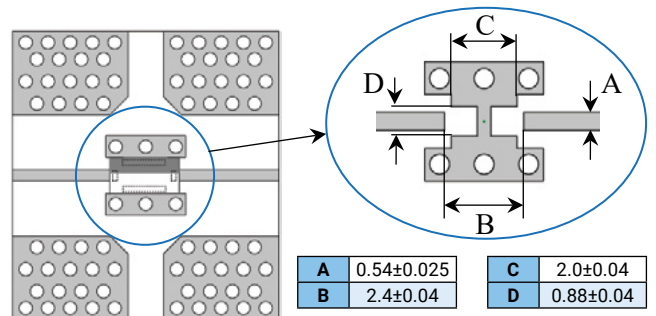

A	0.54±0.025	C	2.0±0.04
B	2.4±0.04	D	0.88±0.04



The Important Information/Disclaimer is incorporated in the catalog where these specifications came from or available online at www.kyocera-avx.com/disclaimer/ by reference and should be reviewed in full before placing any order.

071922

Thin-Film RF/Microwave Filters

High Performance Low Pass Filters

LP1206A3000ANTR – LGA Termination



TYPICAL ELECTRICAL PERFORMANCE

Parameter	Value	Unit	Notes
Fc	3000	MHz	
Insertion Loss	-0.7	dB	Max.
VSWR	1.49 : 1		Max. (all ports)
Rejection	-40	dB	Typ. (6.0 – 9.0 GHz)
Rejection	-30	dB	Typ. (9.0 – 12.0 GHz)
Power Handling	1.67 : 1	W	Continuous
Impedance	50	Ohm	
Operating Temp.	-40 to +85	°C	
Size	1206		

[Click here to return to main table.](#)

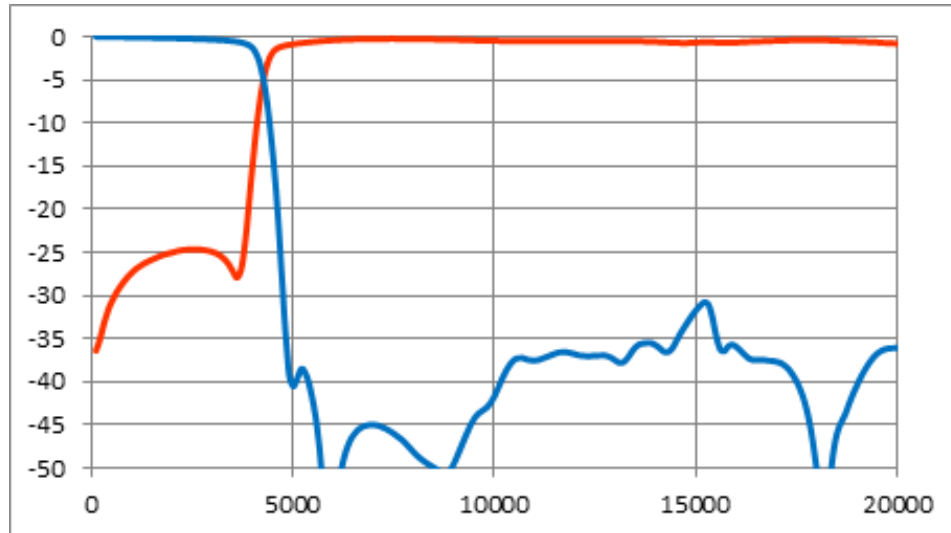

DIMENSIONS: mm (inches)

(Bottom View)

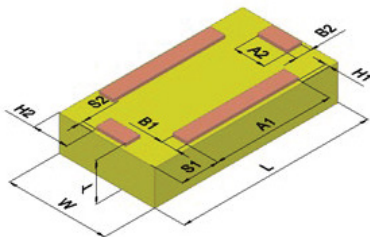

L	3.1±0.1	B1,B2	0.25±0.1
W	1.6±0.1	H1	0.06±0.06
T	0.6±0.3	H2	0.56±0.10
A1	1.9±0.1	S1	0.61±0.1
A2	0.5±0.1	S2	0.06±0.06

TERMINALS:

(Top View)

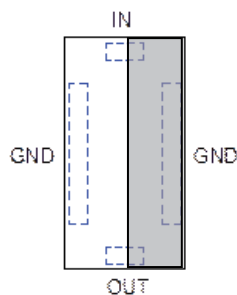

RECOMMENDED PAD LAYOUT: (mm)

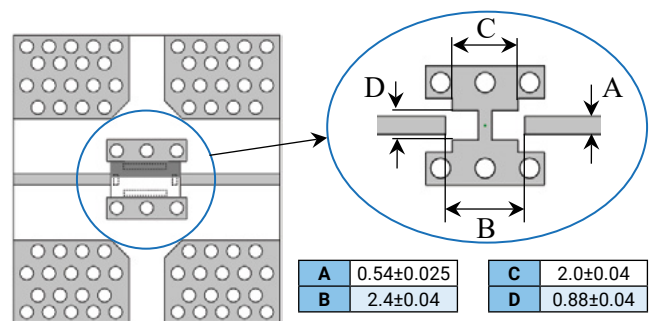

A	0.54±0.025	C	2.0±0.04
B	2.4±0.04	D	0.88±0.04

Thin-Film RF/Microwave Filters

High Performance Low Pass Filters

LP1206A3200ANTR – LGA Termination



TYPICAL ELECTRICAL PERFORMANCE

Parameter	Value	Unit	Notes
Fc	3200	MHz	
Insertion Loss	-0.7	dB	Max.
VSWR	1.49 : 1		Max. (all ports)
Rejection	-38	dB	Typ. (6.4 – 10.0 GHz)
Rejection	-30	dB	Typ. (10.0 – 12.8 GHz)
Power Handling	1.67 : 1	W	Continuous
Impedance	50	Ohm	
Operating Temp.	-40 to +85	°C	
Size	1206		

[Click here to return to main table.](#)

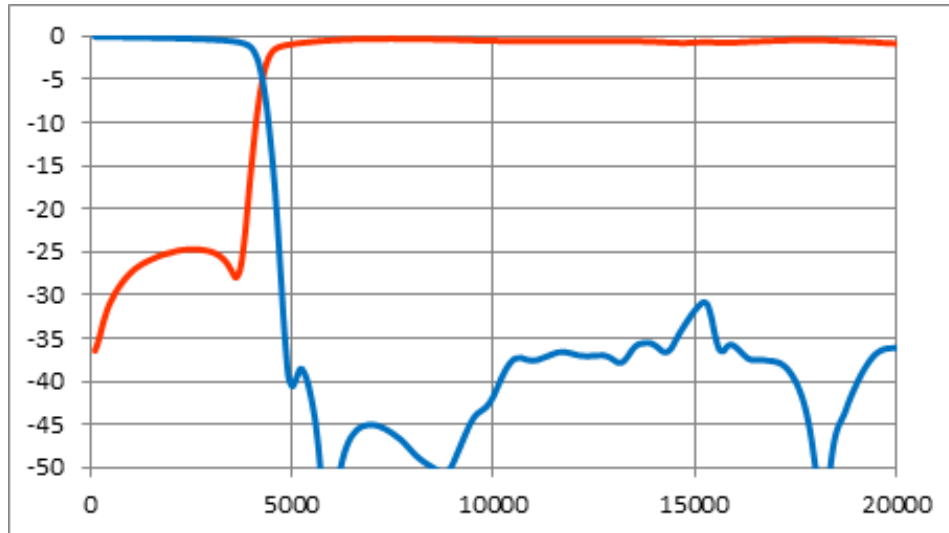

DIMENSIONS: mm (inches) (Bottom View)

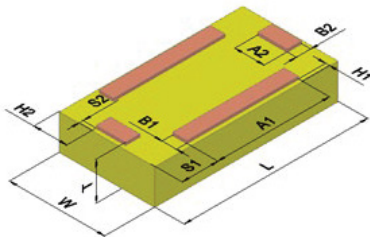

L	3.1±0.1	B1,B2	0.25±0.1
W	1.6±0.1	H1	0.06±0.06
T	0.6±0.3	H2	0.56±0.10
A1	1.9±0.1	S1	0.61±0.1
A2	0.5±0.1	S2	0.06±0.06

TERMINALS: (Top View)

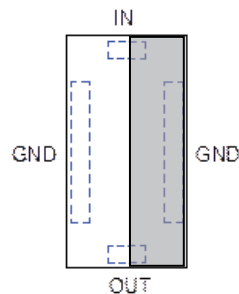

RECOMMENDED PAD LAYOUT: (mm)

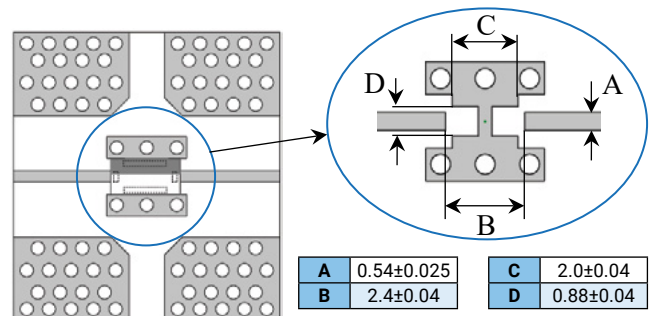

A	0.54±0.025	C	2.0±0.04
B	2.4±0.04	D	0.88±0.04

Thin-Film RF/Microwave Filters

High Performance Low Pass Filters

LP1206A3300ANTR – LGA Termination



TYPICAL ELECTRICAL PERFORMANCE

Parameter	Value	Unit	Notes
Fc	3300	MHz	
Insertion Loss	-0.7	dB	Max.
VSWR	1.49 : 1		Max. (all ports)
Rejection	-38	dB	Typ. (6.4 – 10.0 GHz)
Rejection	-30	dB	Typ. (10.0 – 12.8 GHz)
Power Handling	1.67 : 1	W	Continuous
Impedance	50	Ohm	
Operating Temp.	-40 to +85	°C	
Size	1206		

[Click here to return to main table.](#)

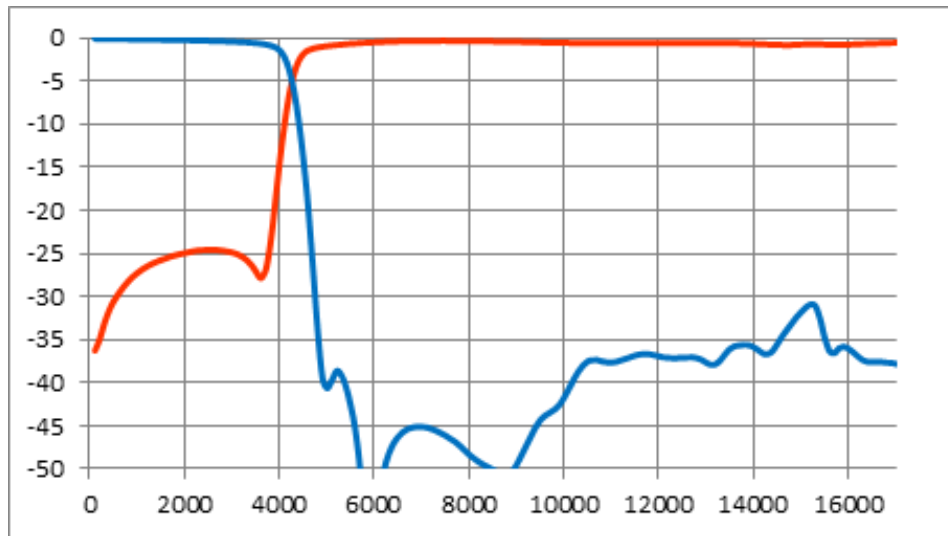

DIMENSIONS: mm (inches) (Bottom View)

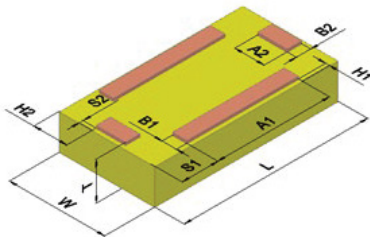

L	3.1±0.1	B1,B2	0.25±0.1
W	1.6±0.1	H1	0.06±0.06
T	0.6±0.3	H2	0.56±0.10
A1	1.9±0.1	S1	0.61±0.1
A2	0.5±0.1	S2	0.06±0.06

TERMINALS: (Top View)

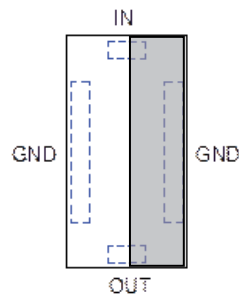

RECOMMENDED PAD LAYOUT: (mm)

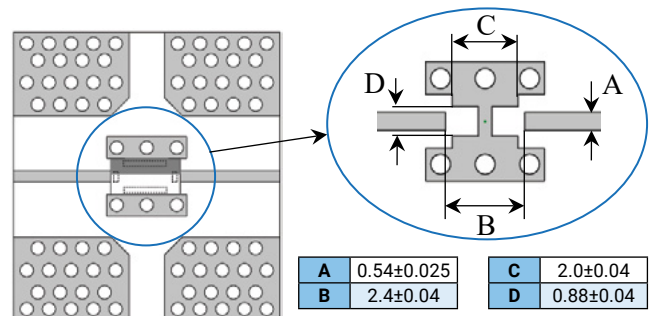

A	0.54±0.025	C	2.0±0.04
B	2.4±0.04	D	0.88±0.04

Thin-Film RF/Microwave Filters

High Performance Low Pass Filters

LP1206A3500ANTR – LGA Termination



TYPICAL ELECTRICAL PERFORMANCE

Parameter	Value	Unit	Notes
Fc	3500	MHz	
Insertion Loss	-0.7	dB	Max.
VSWR	1.49 : 1		Max. (all ports)
Rejection	-38	dB	Typ. (6.0 – 10.5 GHz)
Rejection	-30	dB	Typ. (10.5 – 15 GHz)
Power Handling	1.67 : 1	W	Continuous
Impedance	50	Ohm	
Operating Temp.	-40 to +85	°C	
Size	1206		

[Click here to return to main table.](#)

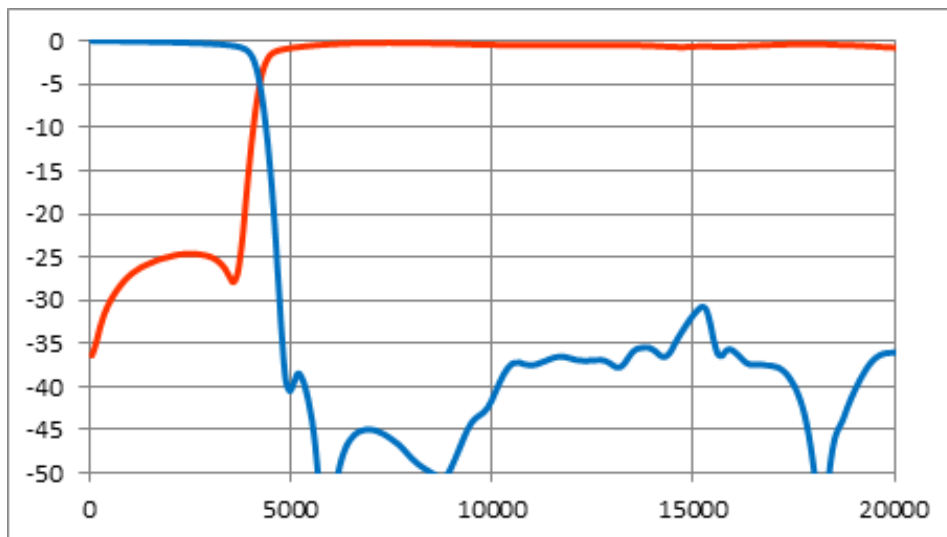

DIMENSIONS: mm (inches)

(Bottom View)

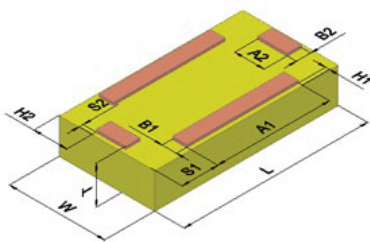

L	3.1±0.1	B1,B2	0.25±0.1
W	1.6±0.1	H1	0.06±0.06
T	0.6±0.3	H2	0.56±0.10
A1	1.9±0.1	S1	0.61±0.1
A2	0.5±0.1	S2	0.06±0.06

TERMINALS:

(Top View)

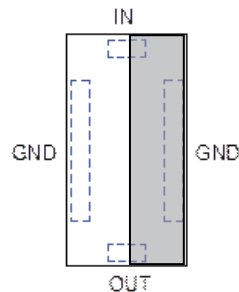

RECOMMENDED PAD LAYOUT: (mm)

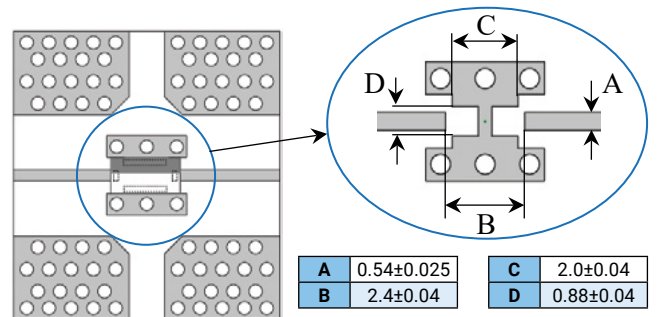

Thin-Film RF/Microwave Filters

1206 High Performance Low Pass 12W

LP1206A5000ANTR – LGA Termination



TYPICAL ELECTRICAL PERFORMANCE

Parameter	Value	Unit	Notes
Fc	5000	MHz	
Insertion Loss	-0.7	dB	
R. Loss 0-5GHz	-15	dB	
Rejection	-35	dB	Min. 9.0 - 14.0 GHz
Rejection	-25	dB	Min. 14.0 - 20.0
Power Handling	12	W	RF Continuous
Impedance	50	Ohm	
Operating Temp.	-40 to +85	°C	
Size	1206		

[Click here to return to main table.](#)

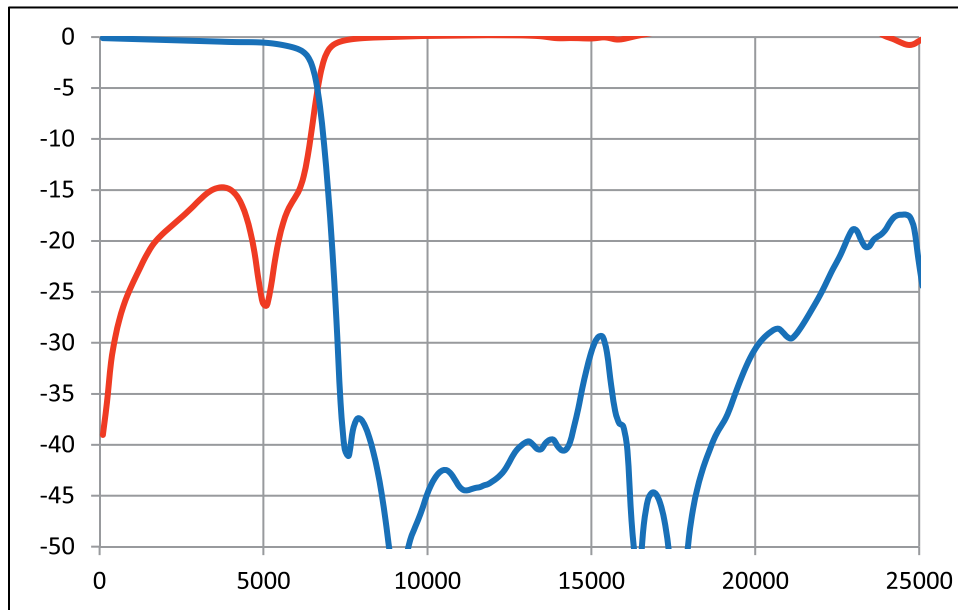

DIMENSIONS: mm (inches)

(Bottom View)

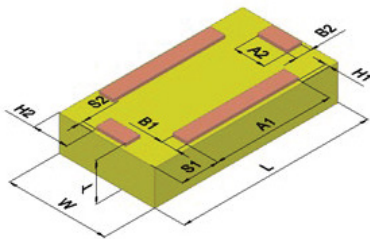

L	3.1±0.1	B1,B2	0.25±0.1
W	1.6±0.1	H1	0.06±0.06
T	0.6±0.3	H2	0.56±0.10
A1	1.9±0.1	S1	0.61±0.1
A2	0.5±0.1	S2	0.06±0.06

TERMINALS:

(Top View)

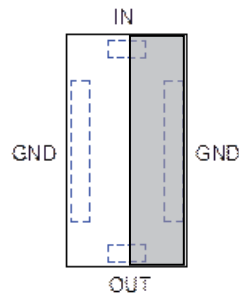

RECOMMENDED PAD LAYOUT: (mm)

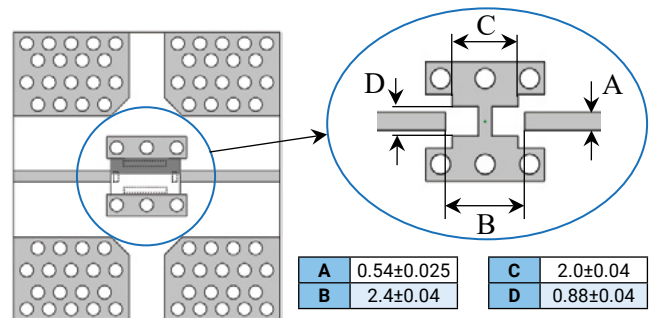

A	0.54±0.025	C	2.0±0.04
B	2.4±0.04	D	0.88±0.04

Thin-Film RF/Microwave Filters

1206 High Performance Low Pass 12W

LP1206A5200ANTR – LGA Termination



TYPICAL ELECTRICAL PERFORMANCE

Parameter	Value	Unit	Notes
Fc	5200	MHz	
Insertion Loss	-0.75	dB	
R. Loss 0-5GHz	-15	dB	
Rejection	-35	dB	Min. 8.0 - 14.0 GHz
Rejection	-25	dB	Min. 14.0 - 20.0
Power Handling	12	W	RF Continuous
Impedance	50	Ohm	
Operating Temp.	-40 to +85	°C	
Size	1206		

[Click here to return to main table.](#)

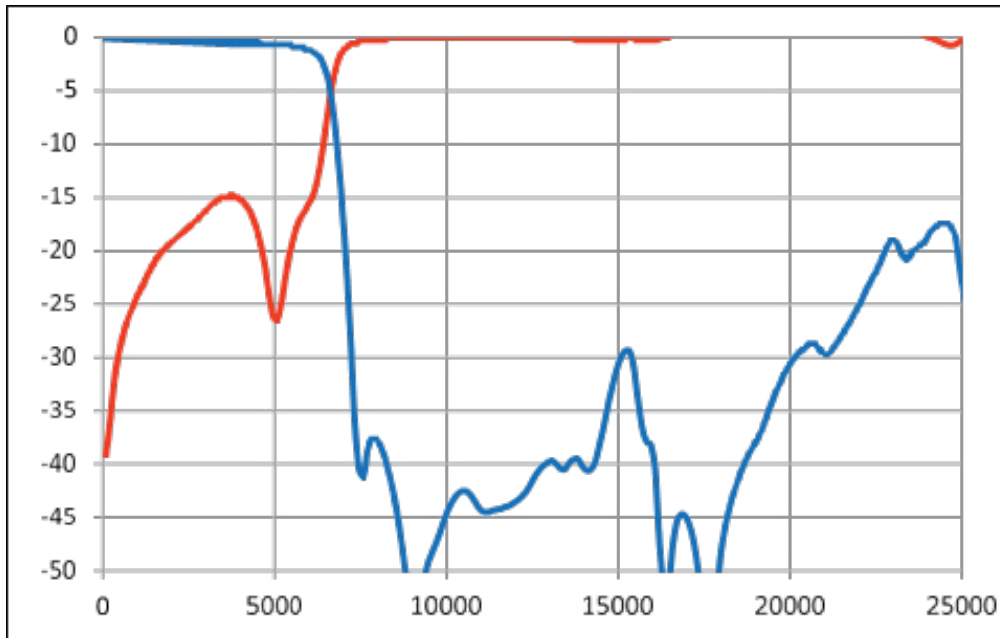

DIMENSIONS: mm (inches) (Bottom View)

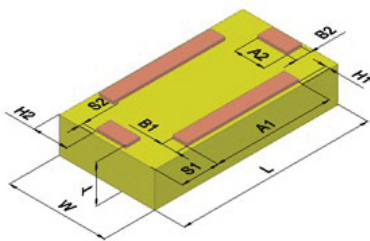

L	3.1±0.1	B1,B2	0.25±0.1
W	1.6±0.1	H1	0.06±0.06
T	0.6±0.3	H2	0.56±0.10
A1	1.9±0.1	S1	0.61±0.1
A2	0.5±0.1	S2	0.06±0.06

TERMINALS: (Top View)

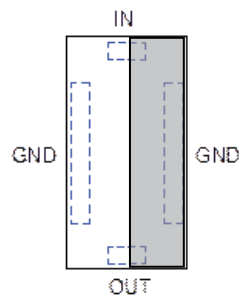

RECOMMENDED PAD LAYOUT: (mm)

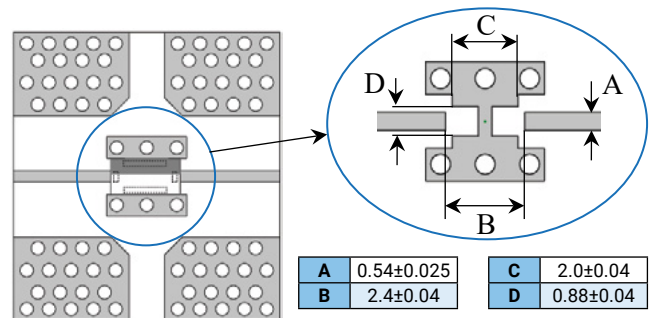

A	0.54±0.025	C	2.0±0.04
B	2.4±0.04	D	0.88±0.04



The Important Information/Disclaimer is incorporated in the catalog where these specifications came from or available online at www.kyocera-avx.com/disclaimer/ by reference and should be reviewed in full before placing any order.

Thin-Film RF/Microwave Filters

1206 High Performance Low Pass 12W

LP1206A5500ANTR – LGA Termination



TYPICAL ELECTRICAL PERFORMANCE

Parameter	Value	Unit	Notes
Fc	5500	MHz	
Insertion Loss	-1.0	dB	
R. Loss 0-5GHz	-12	dB	
Rejection	-30	dB	Min. 9.0 - 14.0 GHz
Rejection	-27	dB	Min. 14.0 - 20.0 GHz
Power Handling	12	W	RF Continuous
Impedance	50	Ohm	
Operating Temp.	-40 to +85	°C	
Size			1206

[Click here to return to main table.](#)

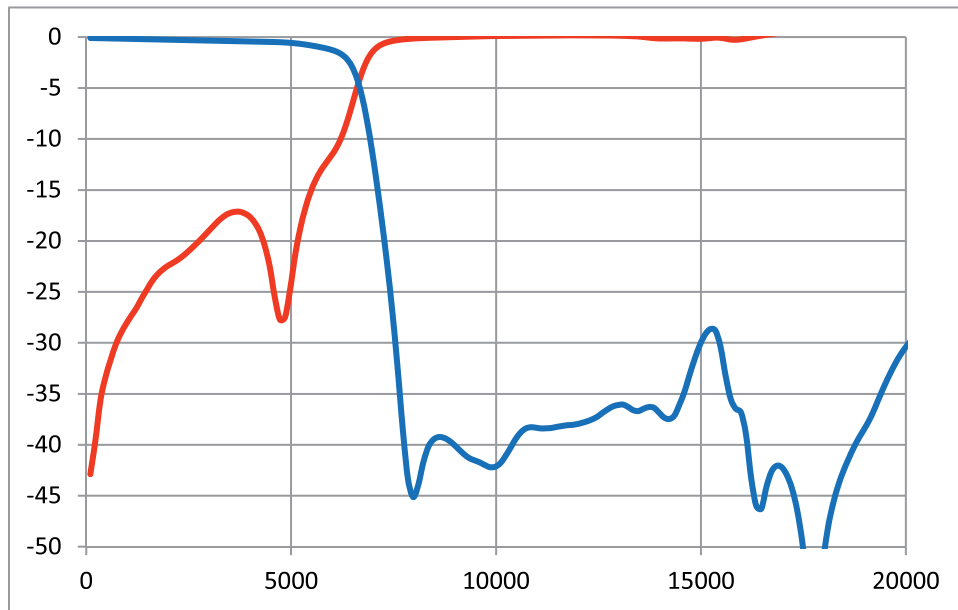

DIMENSIONS: mm (inches) (Bottom View)

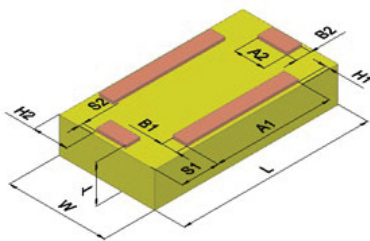

L	3.1±0.1	B1,B2	0.25±0.1
W	1.6±0.1	H1	0.06±0.06
T	0.6±0.3	H2	0.56±0.10
A1	1.9±0.1	S1	0.61±0.1
A2	0.5±0.1	S2	0.06±0.06

TERMINALS: (Top View)

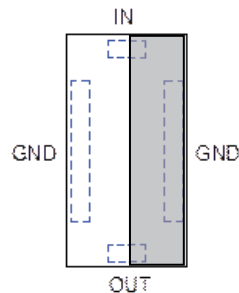

RECOMMENDED PAD LAYOUT: (mm)

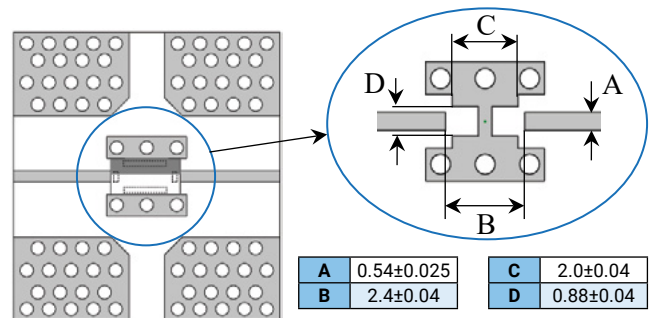

A	0.54±0.025	C	2.0±0.04
B	2.4±0.04	D	0.88±0.04

Thin-Film RF/Microwave Filters

1206 High Performance Low Pass 12W

LP1206A6000ANTR – LGA Termination



TYPICAL ELECTRICAL PERFORMANCE

Parameter	Value	Unit	Notes
Fc	6000	MHz	
Rejection	-35	dB	Min. 8.4-18GHz
Insertion Loss	-0.6	dB	Max.(6GHz)
R.Loss 0-6GHz	-20	dB	
Power Handling	12	W	RF Continuous
Impedance	50	Ohm	
Operating Temp.	-40 to +100	degC	
Size	1206		

[Click here to return to main table.](#)

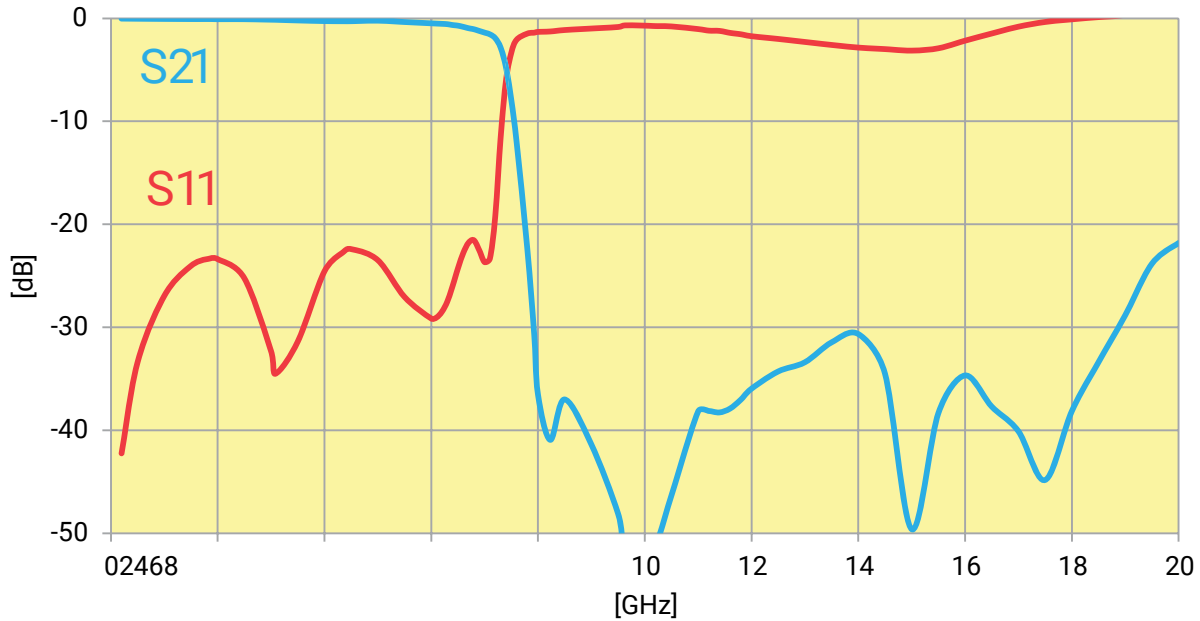

DIMENSIONS: mm (inches) (Bottom View)

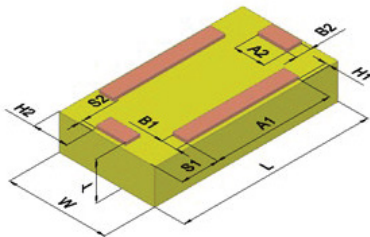

L	3.1±0.1	B1,B2	0.25±0.1
W	1.6±0.1	H1	0.06±0.06
T	0.6±0.3	H2	0.56±0.10
A1	1.9±0.1	S1	0.61±0.1
A2	0.5±0.1	S2	0.06±0.06

TERMINALS: (Top View)

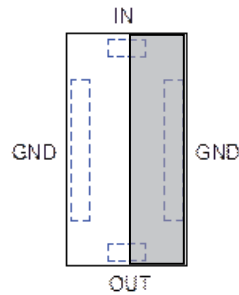

RECOMMENDED PAD LAYOUT: (mm)

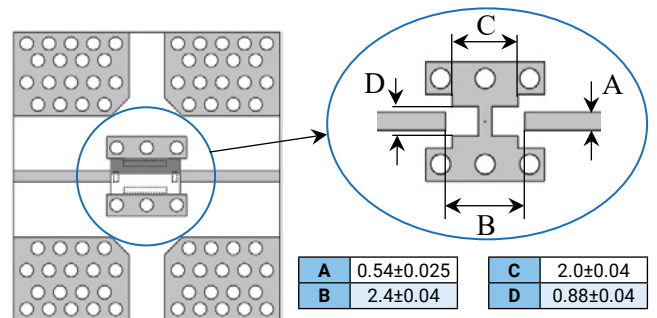

A	0.54±0.025	C	2.0±0.04
B	2.4±0.04	D	0.88±0.04



High Performance Low Pass Filters

1206 High Performance SMD 8W

Thin-Film RF/Microwave Filters

1206 High Performance Low Pass 8W

General Information – SMD Termination



ITF TECHNOLOGY

The ITF SMD Filter is based on thin-film multilayer technology. The technology provides a miniature part with excellent high frequency performance and rugged construction for reliable automatic assembly.

The ITF Filter is offered in a variety of frequency bands compatible with various types of high frequency wireless systems.

FEATURES

- Small size: 1206
- Frequency: 700-3800MHz
- Sharp attenuation slope
- Characteristic impedance: 50Ohm
- Operating/Storage temp: -40°C – +85°C
- Low profile
- Rugged construction
- Taped and reeled
- Power handling: 8W

APPLICATIONS

- Base Station
- 5G & 6G / UWB
- Mobile communications
- Satellite TV receivers
- GPS
- Vehicle location systems
- Wireless LAN's

FINAL QUALITY INSPECTION

Finished parts are 100% tested for electrical parameters and visual/ mechanical characteristics. Each production lot is evaluated on a sample basis for:

- Static Humidity: 85°C, 85% RH, 160 hours
- Endurance : 125°C, IR, 4 hours

TERMINATION

Nickel/ Lead free Solder coating (Sn100) compatible with automatic soldering technologies: reflow, wave soldering, vapor phase and manual.

HOW TO ORDER

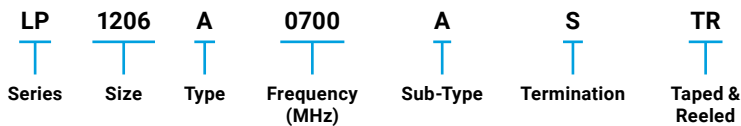

ELECTRICAL SPECIFICATION

Part Number	Fc [MHz]	I.L [dB] @Fc	VSWR @ Fc	Rejection [dB]	Rejection [dB]	Rejection [dB]	Rejection [dB]
LP1206A0700ASTR	700	-0.8	1:1.22	-20dB at 980MHz	-45dB at 1400MHz	-45dB at 2100MHz	-30dB at 2800MHz
LP1206A0860ASTR	860	-0.85	1:1.285	-25dB at 1204MHz	-45dB at 1720MHz	-45dB at 2580MHz	-30dB at 3440MHz
LP1206A1000ASTR	1000	-0.7	1:1.43	-30dB at 1500 - 2000MHz	-25dB at 2000 - 3000MHz	-25dB at 3000 - 4000MHz	-----
LP1206A1100ASTR	1100	-0.8	1:1.43	-30dB at 2000 - 4000MHz	-----	-----	-----
LP1206A1500ASTR	1500	-0.7	1:1.43	-30dB at 2000 - 3000MHz	-25dB at 3000 - 4000MHz	-20dB at 4500 - 6000 MHz	-----
LP1206A1600ASTR	1600	-0.8	1:1.43	-30dB at 2200 - 4000MHz	-20dB at 4000 - 6000MHz	-----	-----
LP1206A2000ASTR	2000	-0.8	1:1.43	-27dB at 3000 - 4000MH	-25dB at 4000 - 6000MHz	-20dB at 6000 - 8000MHz	-----
LP1206A2500ASTR	2500	-0.8	1:1.43	-27dB at 4000 - 5000MHz	-25dB at 5000 - 7500MHz	-25dB at 7500 - 8500MHz	-----
LP1206A2600ASTR	2600	-0.7	1:1.43	-25dB at 4000 - 6000MHz	-18dB at 6000 - 8000MHz	-----	-----
LP1206A3200ASTR	3200	-0.85	1:1.22	-30dB at 4.48GHz	-40dB at 6.4GHz	-25dB at 9.6GHz	-25dB at 10GHz
LP1206A3500ASTR	3500	-0.7	1:1.285	-30dB at 4.9GHz	-40dB at 7GHz	-25dB at 10.5GHz	-15dB at 11GHz
LP1206A3600ASTR	3600	-0.7	1:1.12	-30dB at 5.04GHz	-35dB at 7.2GHz	-25dB at 10.8GHz	-----
LP1206A3800ASTR	3800	0.8	1:1.22	-35dB at 5.32GHz	-28dB at 7.6GHz	-33dB at 10GHz	-----

Click on part number to see full specifications

Thin-Film RF/Microwave Filters

1206 High Performance Low Pass 8W

LP1206A0700ASTR – SMD Termination



TYPICAL ELECTRICAL PERFORMANCE

P/N	I.Loss @ 700MHz	R.Loss @ 700MHz	Attenuation
LP1206A0700ASTR	0.8dB max.	-20dB	-20dB at 980MHz -45dB at 1400MHz -45dB at 2100MHz -30dB at 2800MHz

[Click here to return to main table.](#)

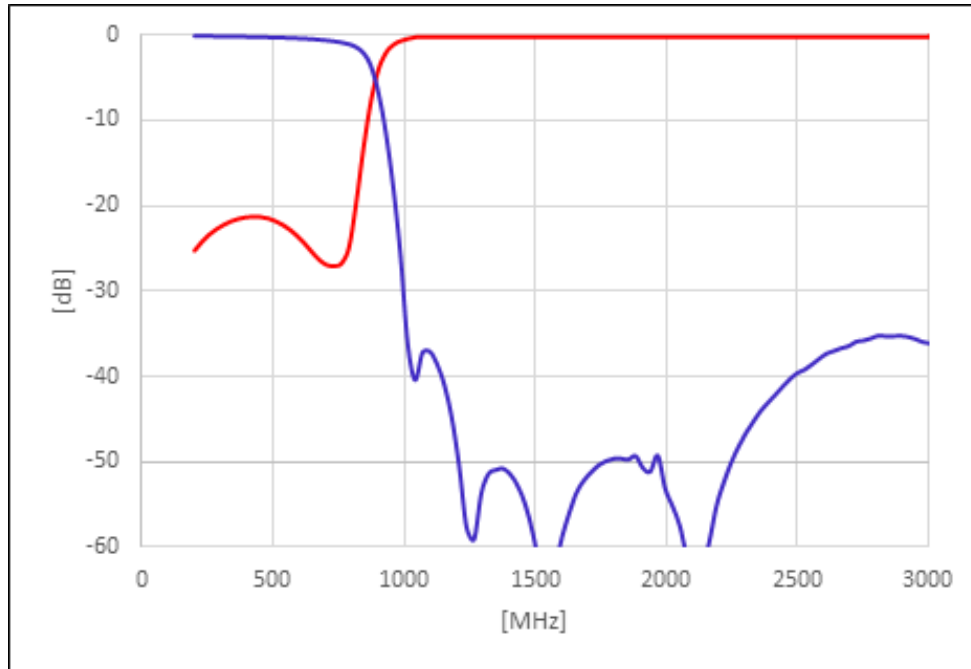

DIMENSIONS (TOP VIEW)

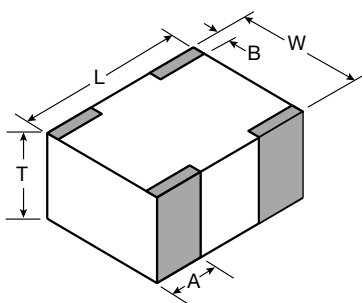

mm (inches)

L	3.08±0.1 (0.121±0.004)
W	1.60±0.1 (0.063±0.004)
T	0.87±0.1 (0.034±0.004)
A	0.61±0.25 (0.028±0.010)
B	0.35±0.15 (0.014±0.006)

RECOMMENDED PAD LAYOUT

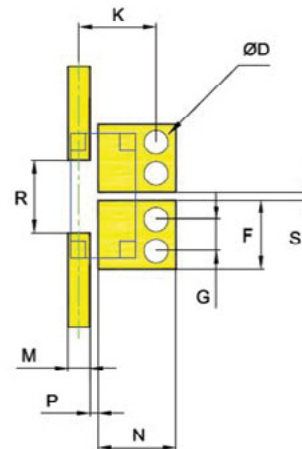

mm (inches)

F	1.70±0.05 (0.067±0.002)
G	0.78±0.05 (0.031±0.002)
K	1.91±0.10 (0.075±0.004)
M	0.54±0.025 (0.021±0.001)
N	1.93±0.05 (0.076±0.002)
P	0.21±0.04 (0.008±0.002)
R	1.80±0.04 (0.071±0.002)
S	0.20±0.04 (0.008±0.002)
D	0.60±0.10 (0.024±0.004)

TERMINAL AND LAYOUT (TOP VIEW)

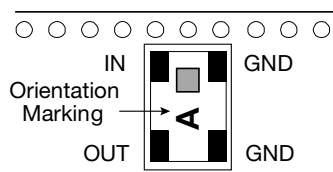

Thin-Film RF/Microwave Filters

1206 High Performance Low Pass 8W

LP1206A0860ASTR – SMD Termination



TYPICAL ELECTRICAL PERFORMANCE

P/N	I.Loss @ 860MHz	R.Loss @ 860MHz	Attenuation
LP1206A0860ASTR	0.85dB max.	-18dB	-25dB at 1204MHz -45dB at 1720MHz -45dB at 2580MHz -30dB at 3440MHz

[Click here to return to main table.](#)

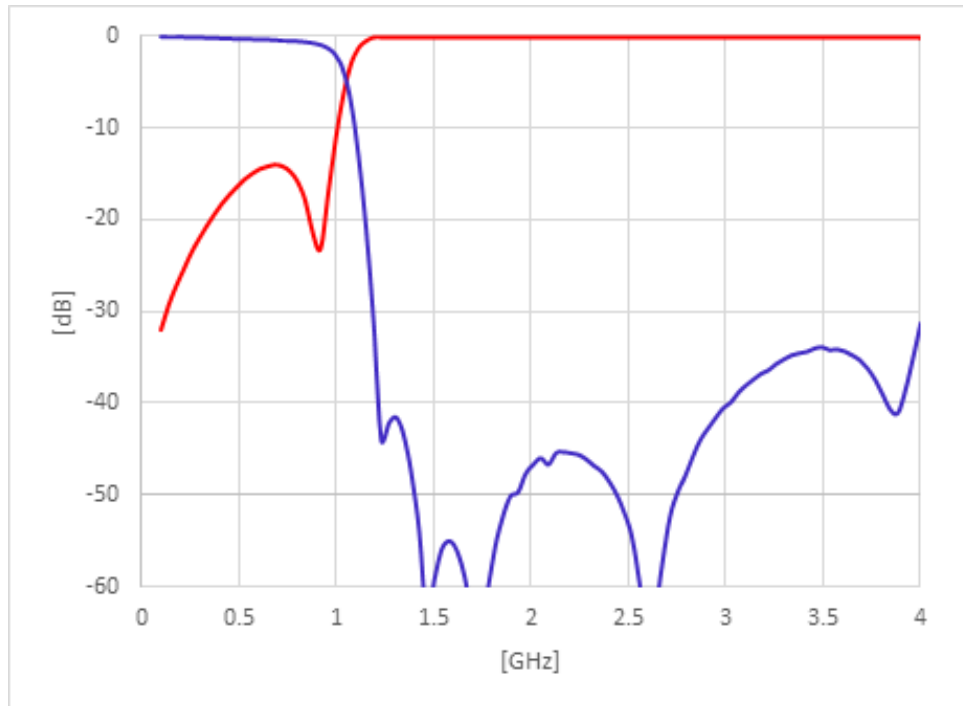

DIMENSIONS (TOP VIEW)

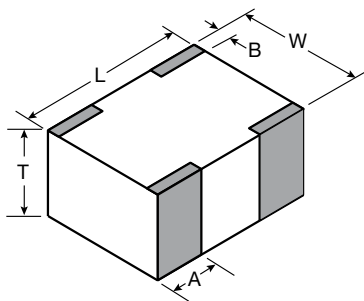

mm (inches)

L	3.08±0.1 (0.121±0.004)
W	1.60±0.1 (0.063±0.004)
T	0.87±0.1 (0.034±0.004)
A	0.61±0.25 (0.028±0.010)
B	0.35±0.15 (0.014±0.006)

RECOMMENDED PAD LAYOUT

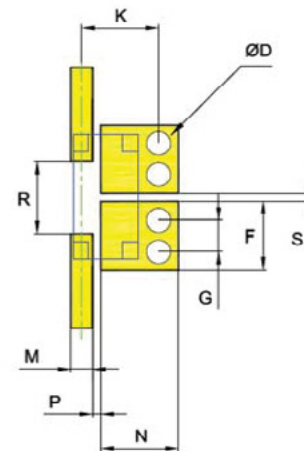

mm (inches)

F	1.70±0.05 (0.067±0.002)
G	0.78±0.05 (0.031±0.002)
K	1.91±0.10 (0.075±0.004)
M	0.54±0.025 (0.021±0.001)
N	1.93±0.05 (0.076±0.002)
P	0.21±0.04 (0.008±0.002)
R	1.80±0.04 (0.071±0.002)
S	0.20±0.04 (0.008±0.002)
D	0.60±0.10 (0.024±0.004)

TERMINAL AND LAYOUT (TOP VIEW)

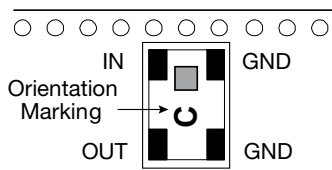

The Important Information/Disclaimer is incorporated in the catalog where these specifications came from or available online at www.kyocera-avx.com/disclaimer/ by reference and should be reviewed in full before placing any order.

Thin-Film RF/Microwave Filters

1206 High Performance Low Pass 8W

LP1206A1000ASTR – SMD Termination



TYPICAL ELECTRICAL PERFORMANCE

P/N	I.Loss @ 1000MHz	R.Loss @ 1000MHz	ATTENUATION [min.]
LP1206A1000ASTR	0.7dB max.	-15dB	-30dB at 1500-2000MHz -25dB at 2000-3000MHz -25dB at 3000-4000MHz

[Click here to return to main table.](#)

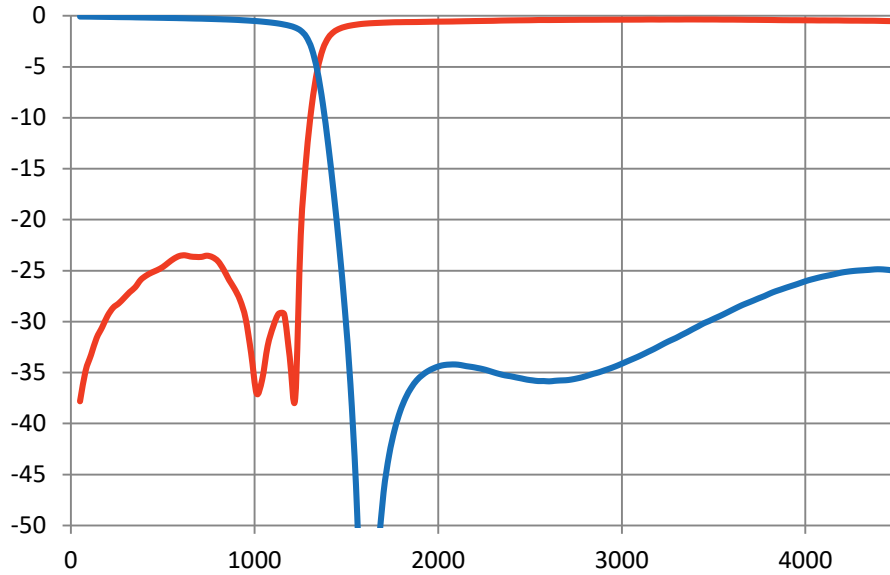

DIMENSIONS

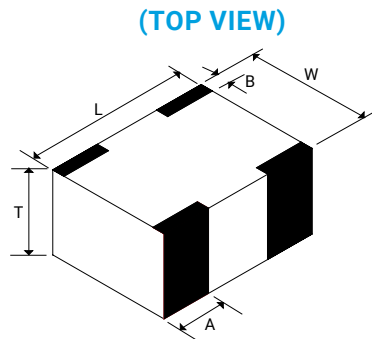

(TOP VIEW)

mm (inches)

L	3.08±0.1 (0.121±0.004)
W	1.60±0.1 (0.063±0.004)
T	0.87±0.1 (0.034±0.004)
A	0.61±0.25 (0.028±0.010)
B	0.35±0.15 (0.014±0.006)

RECOMMENDED PAD LAYOUT

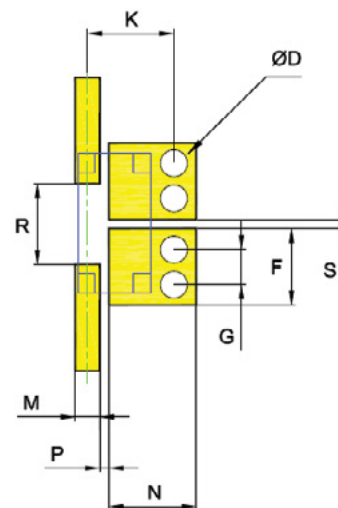

(mm)

F	1.70±0.05
G	0.78±0.05
K	1.91±0.10
M	0.54±0.025
N	1.93±0.05
P	0.21±0.04
R	1.80±0.04
S	0.20±0.04
D	0.6±0.1

TERMINALS (TOP VIEW)

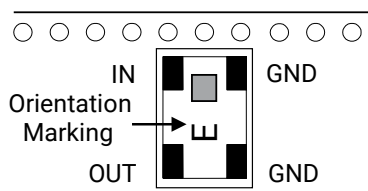

Thin-Film RF/Microwave Filters

1206 High Performance Low Pass 8W

LP1206A1100ASTR – SMD Termination



TYPICAL ELECTRICAL PERFORMANCE

P/N	I.Loss @ 1100MHz	R.Loss @ 1100MHz	ATTENUATION [min.]
LP1206A1100ASTR	0.8dB max.	-15dB	-30dB at 2000-4000MHz

[Click here to return to main table.](#)

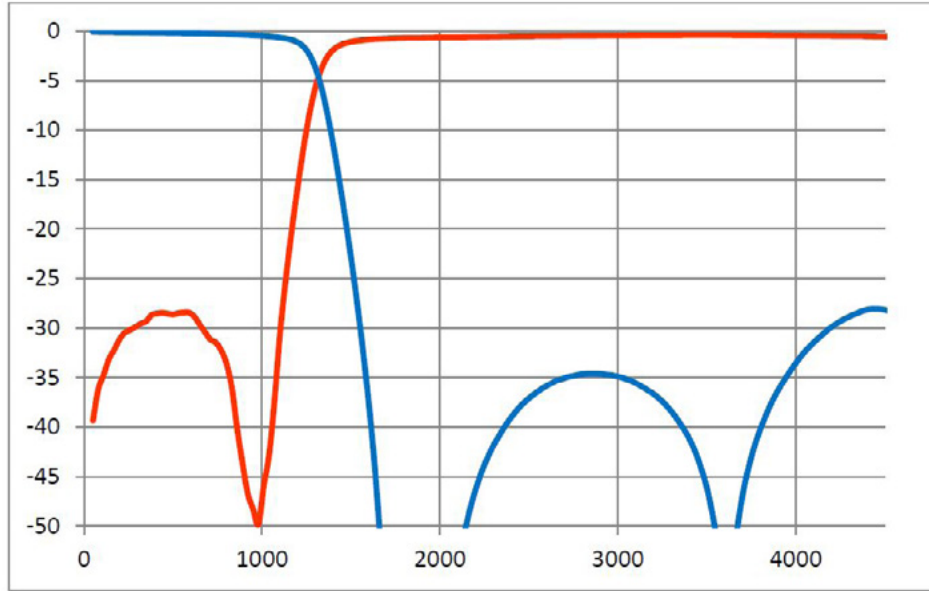

DIMENSIONS

(TOP VIEW)

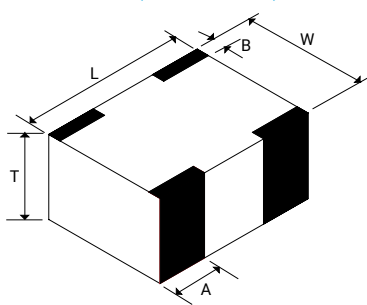

mm (inches)

L	3.08±0.1 (0.121±0.004)
W	1.60±0.1 (0.063±0.004)
T	0.87±0.1 (0.034±0.004)
A	0.61±0.25 (0.028±0.010)
B	0.35±0.15 (0.014±0.006)

RECOMMENDED PAD LAYOUT

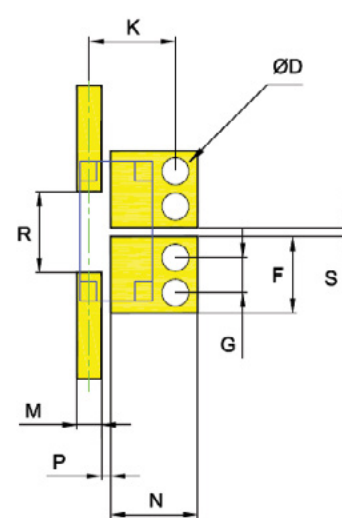

(mm)

F	1.70±0.05
G	0.78±0.05
K	1.91±0.10
M	0.54±0.025
N	1.93±0.05
P	0.21±0.04
R	1.80±0.04
S	0.20±0.04
D	0.6±0.1

TERMINALS (TOP VIEW)

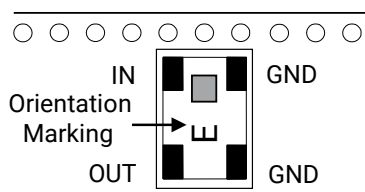

Thin-Film RF/Microwave Filters

1206 High Performance Low Pass 8W

LP1206A1500ASTR – SMD Termination



TYPICAL ELECTRICAL PERFORMANCE

P/N	I.Loss @ 1500MHz	R.Loss @ 1500MHz	ATTENUATION [min.]
LP1206A1500ASTR	0.8dB max.	-15dB	-30dB at 2000-3000MHz -25dB at 3000-4000MHz -20dB at 4500-6000MHz

[Click here to return to main table.](#)

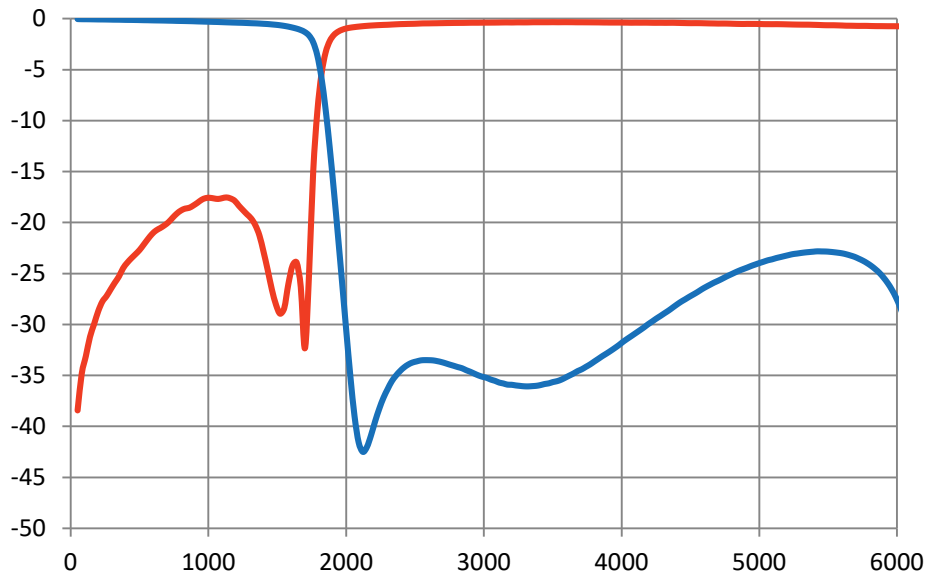

DIMENSIONS (TOP VIEW)

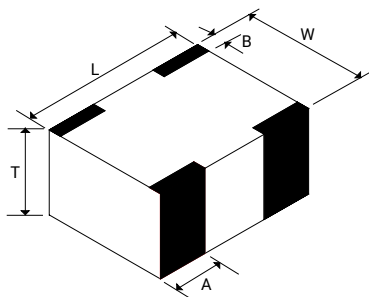

mm (inches)	
L	3.08±0.1 (0.121±0.004)
W	1.60±0.1 (0.063±0.004)
T	0.87±0.1 (0.034±0.004)
A	0.61±0.25 (0.028±0.010)
B	0.35±0.15 (0.014±0.006)

RECOMMENDED PAD LAYOUT

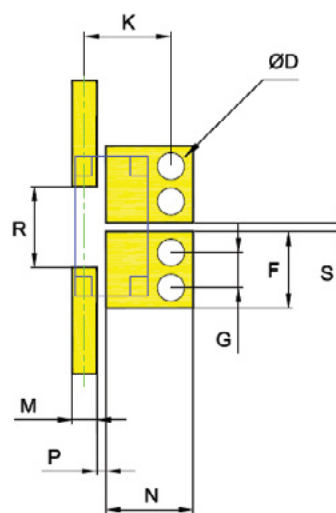

(mm)	
F	1.70±0.05
G	0.78±0.05
K	1.91±0.10
M	0.54±0.025
N	1.93±0.05
P	0.21±0.04
R	1.80±0.04
S	0.20±0.04
D	0.6±0.1

TERMINALS (TOP VIEW)

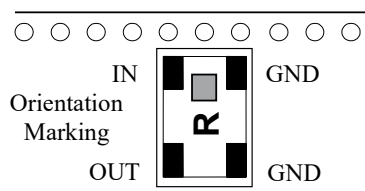

Thin-Film RF/Microwave Filters

1206 High Performance Low Pass 8W

LP1206A1600ASTR – SMD Termination



TYPICAL ELECTRICAL PERFORMANCE

P/N	I.Loss @ 1600MHz	R.Loss @ 1600MHz	ATTENUATION [min.]
LP1206A1600ASTR	0.8dB max.	-15dB	-30dB at 2200-4000MHz -20dB at 4001-6000MHz

[Click here to return to main table.](#)

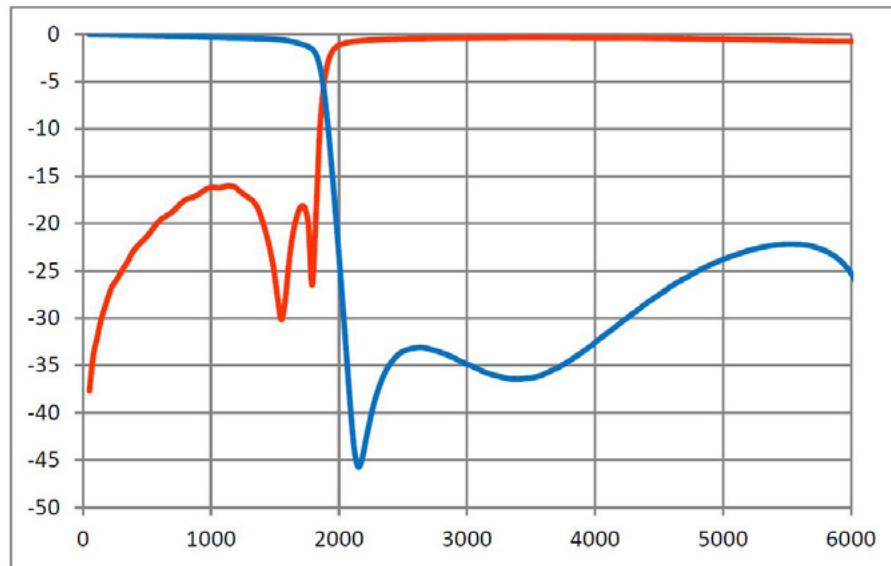

DIMENSIONS (TOP VIEW)

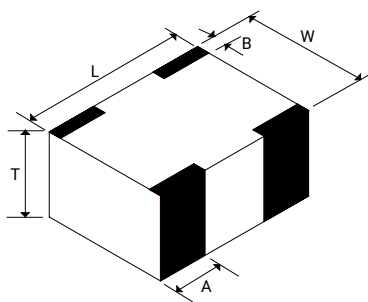

mm (inches)	
L	3.08±0.1 (0.121±0.004)
W	1.60±0.1 (0.063±0.004)
T	0.87±0.1 (0.034±0.004)
A	0.61±0.25 (0.028±0.010)
B	0.35±0.15 (0.014±0.006)

RECOMMENDED PAD LAYOUT

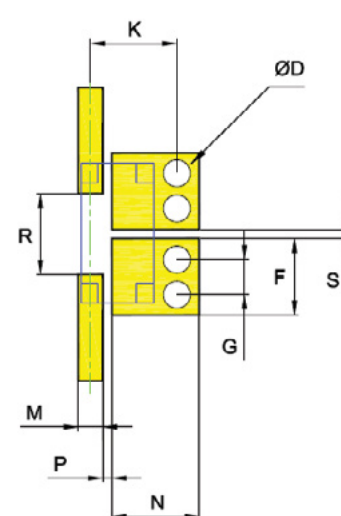

(mm)	
F	1.70±0.05
G	0.78±0.05
K	1.91±0.10
M	0.54±0.025
N	1.93±0.05
P	0.21±0.04
R	1.80±0.04
S	0.20±0.04
D	0.6±0.1

TERMINALS (TOP VIEW)

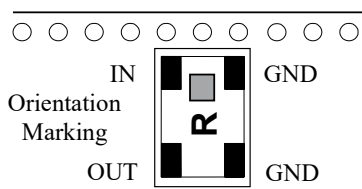

Thin-Film RF/Microwave Filters

1206 High Performance Low Pass 8W

LP1206A2000ASTR – SMD Termination



TYPICAL ELECTRICAL PERFORMANCE

P/N	I.Loss @ 2000MHz	R.Loss @ 2000MHz	ATTENUATION [min.]
LP1206A2000ASTR	0.7dB max.	-15dB	-27dB at 3000-4000MHz -25dB at 4000-6000MHz -20dB at 6000-8000MHz

[Click here to return to main table.](#)

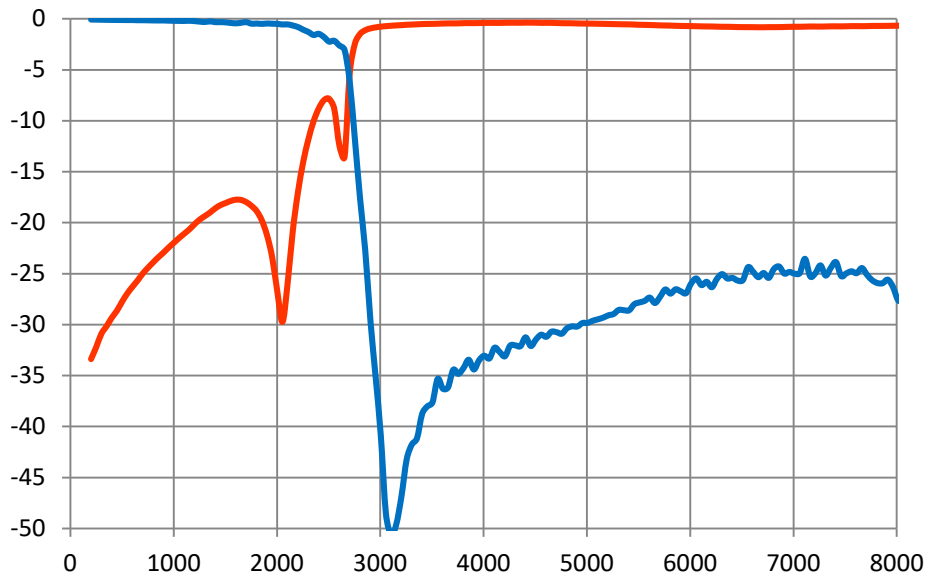

DIMENSIONS

(TOP VIEW)

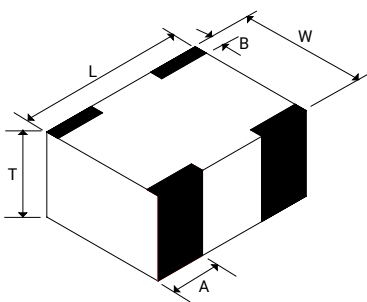

mm (inches)

L	3.08±0.1 (0.121±0.004)
W	1.60±0.1 (0.063±0.004)
T	0.87±0.1 (0.034±0.004)
A	0.61±0.25 (0.028±0.010)
B	0.35±0.15 (0.014±0.006)

RECOMMENDED PAD LAYOUT

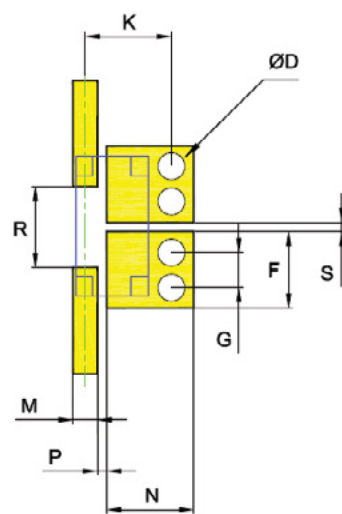

(mm)

F	1.70±0.05
G	0.78±0.05
K	1.91±0.10
M	0.54±0.025
N	1.93±0.05
P	0.21±0.04
R	1.80±0.04
S	0.20±0.04
D	0.6±0.1

TERMINALS (TOP VIEW)

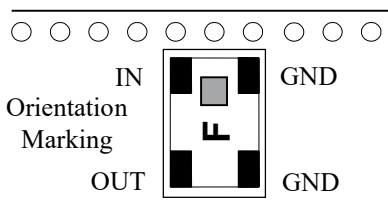

Thin-Film RF/Microwave Filters

1206 High Performance Low Pass 8W

LP1206A2500ASTR – SMD Termination



TYPICAL ELECTRICAL PERFORMANCE

P/N	I.Loss @ 2500MHz	R.Loss @ 2500MHz	ATTENUATION [min.]
LP1206A2500ASTR	0.7dB max.	-15dB	-25dB at 4000-5000MHz -22dB at 5000-7500MHz -15dB at 7500-8500MHz

[Click here to return to main table.](#)

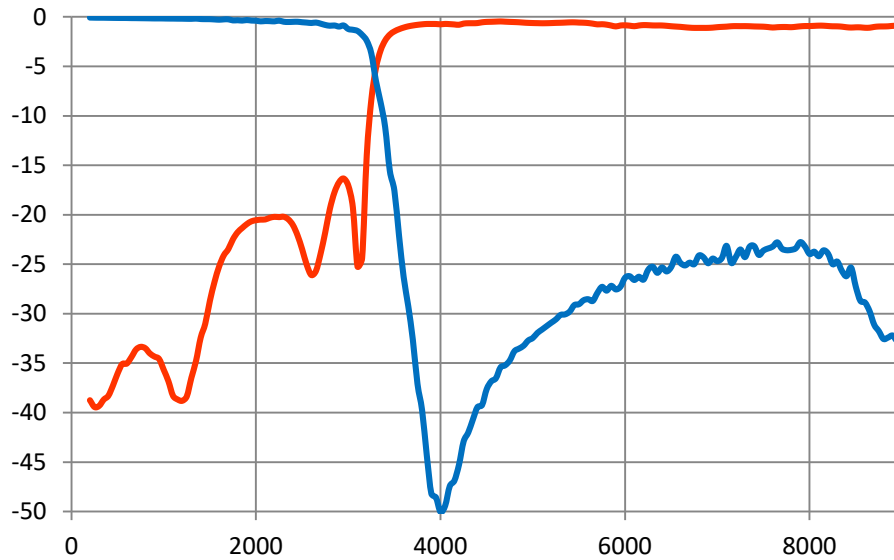

DIMENSIONS

(TOP VIEW)

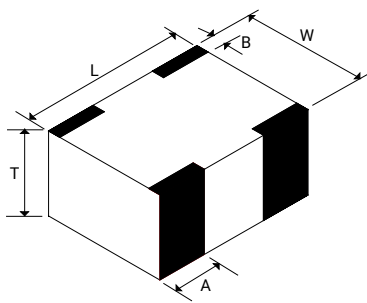

mm (inches)

L	3.08±0.1 (0.121±0.004)
W	1.60±0.1 (0.063±0.004)
T	0.87±0.1 (0.034±0.004)
A	0.61±0.25 (0.028±0.010)
B	0.35±0.15 (0.014±0.006)

RECOMMENDED PAD LAYOUT

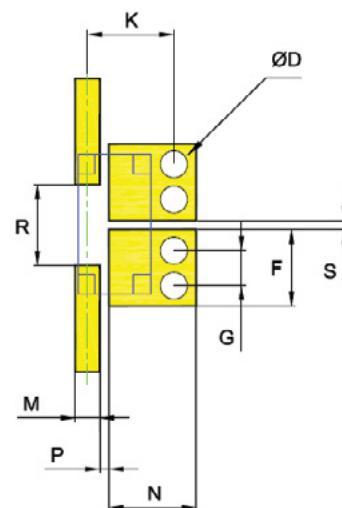

(mm)

F	1.70±0.05
G	0.78±0.05
K	1.91±0.10
M	0.54±0.025
N	1.93±0.05
P	0.21±0.04
R	1.80±0.04
S	0.20±0.04
D	0.6±0.1

TERMINALS AND LAYOUT (TOP VIEW)

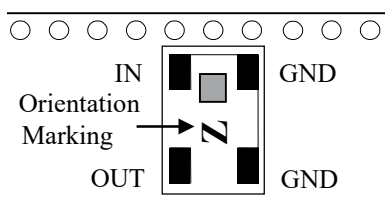

Thin-Film RF/Microwave Filters

1206 High Performance Low Pass 8W

LP1206A2600ASTR – SMD Termination



TYPICAL ELECTRICAL PERFORMANCE

P/N	I.Loss @ 2600MHz	R.Loss @ 2600MHz	ATTENUATION [min.]
LP1206A2600ASTR	0.7dB max.	-15dB	-25dB at 4000-6000MHz -18dB at 6001-8000MHz

[Click here to return to main table.](#)

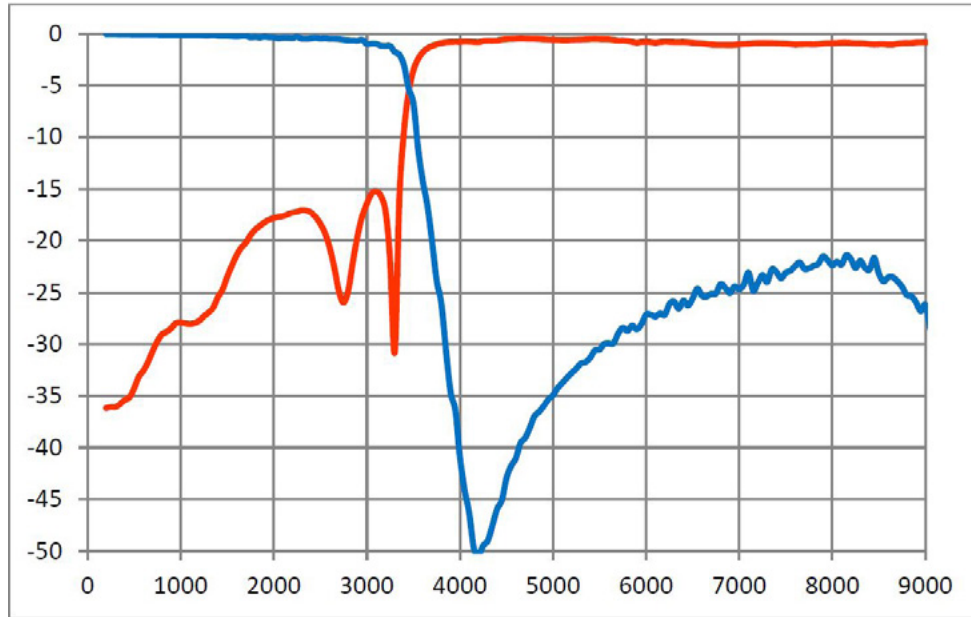

DIMENSIONS

(TOP VIEW)

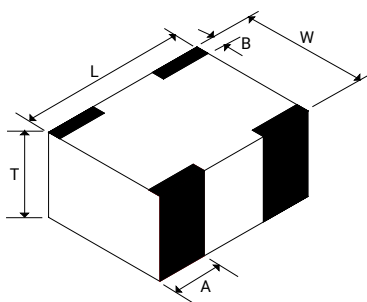

mm (inches)	
L	3.08±0.1 (0.121±0.004)
W	1.60±0.1 (0.063±0.004)
T	0.87±0.1 (0.034±0.004)
A	0.61±0.25 (0.028±0.010)
B	0.35±0.15 (0.014±0.006)

RECOMMENDED PAD LAYOUT

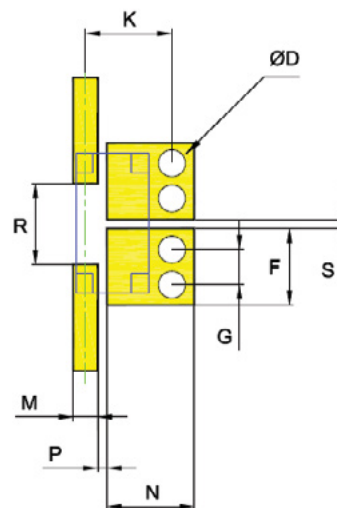

(mm)	
F	1.70±0.05
G	0.78±0.05
K	1.91±0.10
M	0.54±0.025
N	1.93±0.05
P	0.21±0.04
R	1.80±0.04
S	0.20±0.04
D	0.6±0.1

TERMINALS AND LAYOUT (TOP VIEW)

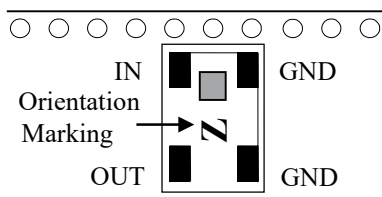

Thin-Film RF/Microwave Filters

1206 High Performance Low Pass 8W

LP1206A3200ASTR – SMD Termination



TYPICAL ELECTRICAL PERFORMANCE

P/N	I.Loss @ 3.2GHz	R.Loss @ 3.2GHz	Attenuation
LP1206A3200ASTR	0.85dB max.	-20dB	-30dB at 4.48GHz -40dB at 6.4GHz -25dB at 9.6GHz -25dB at 10GHz

[Click here to return to main table.](#)

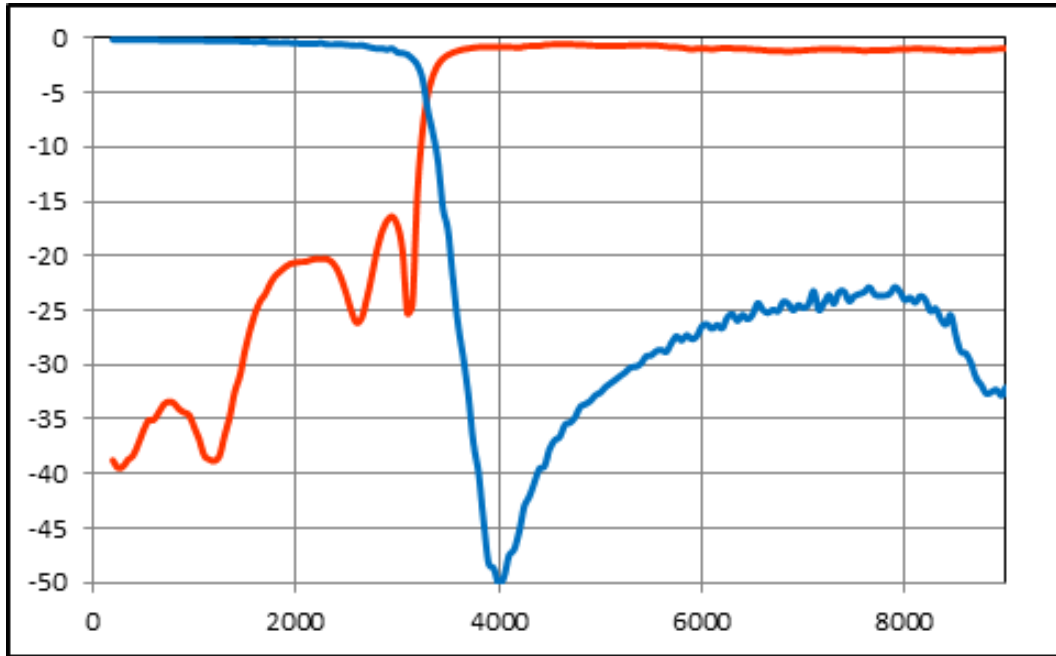

DIMENSIONS (TOP VIEW)

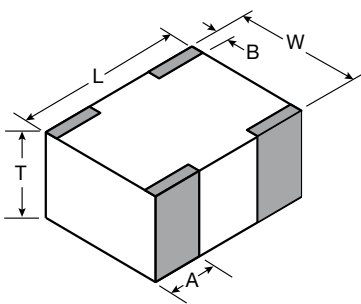

mm (inches)

L	3.08±0.1 (0.121±0.004)
W	1.60±0.1 (0.063±0.004)
T	0.87±0.1 (0.034±0.004)
A	0.61±0.25 (0.028±0.010)
B	0.35±0.15 (0.014±0.006)

RECOMMENDED PAD LAYOUT

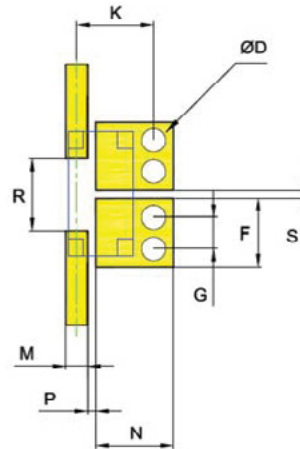

mm (inches)

F	1.70±0.05 (0.067±0.002)
G	0.78±0.05 (0.031±0.002)
K	1.91±0.10 (0.075±0.004)
M	0.54±0.025 (0.021±0.001)
N	1.93±0.05 (0.076±0.002)
P	0.21±0.04 (0.008±0.002)
R	1.80±0.04 (0.071±0.002)
S	0.20±0.04 (0.008±0.002)
D	0.60±0.10 (0.024±0.004)

TERMINAL AND LAYOUT (TOP VIEW)

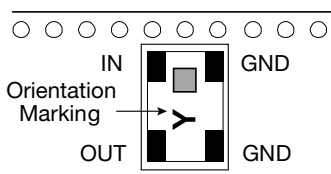

The Important Information/Disclaimer is incorporated in the catalog where these specifications came from or available online at www.kyocera-avx.com/disclaimer/ by reference and should be reviewed in full before placing any order.

071922

Thin-Film RF/Microwave Filters

1206 High Performance Low Pass 8W

LP1206A3500ASTR – SMD Termination



TYPICAL ELECTRICAL PERFORMANCE

P/N	I.Loss @ 3.5GHz	R.Loss @ 3.5GHz	Attenuation
LP1206A3500ASTR	0.7dB max.	-18dB	-30dB at 4.9GHz -40dB at 7GHz -25dB at 10.5GHz -15dB at 11GHz

[Click here to return to main table.](#)

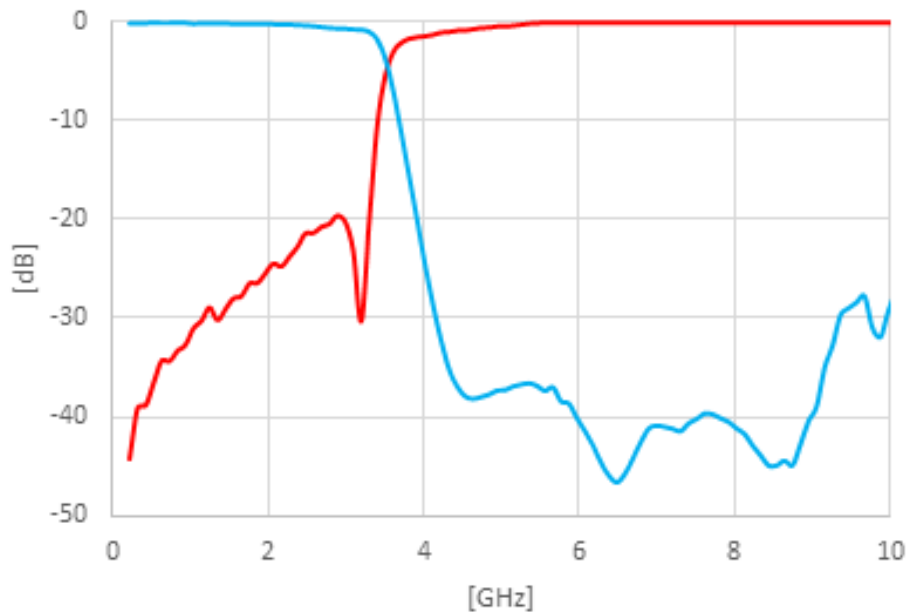

DIMENSIONS (TOP VIEW)

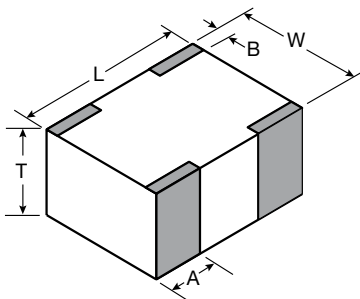

mm (inches)	
L	3.08±0.1 (0.121±0.004)
W	1.60±0.1 (0.063±0.004)
T	0.87±0.1 (0.034±0.004)
A	0.61±0.25 (0.028±0.010)
B	0.35±0.15 (0.014±0.006)

RECOMMENDED PAD LAYOUT

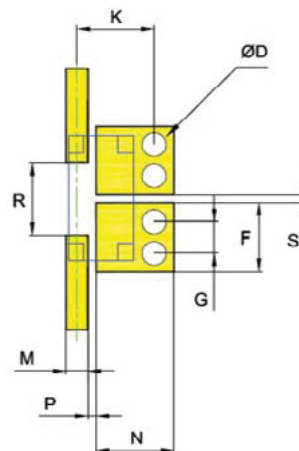

mm (inches)

F	1.70±0.05 (0.067±0.002)
G	0.78±0.05 (0.031±0.002)
K	1.91±0.10 (0.075±0.004)
M	0.54±0.025 (0.021±0.001)
N	1.93±0.05 (0.076±0.002)
P	0.21±0.04 (0.008±0.002)
R	1.80±0.04 (0.071±0.002)
S	0.20±0.04 (0.008±0.002)
D	0.60±0.10 (0.024±0.004)

TERMINAL AND LAYOUT (TOP VIEW)

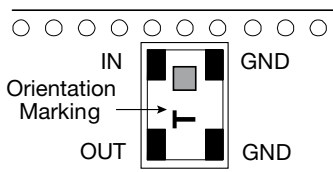

Thin-Film RF/Microwave Filters

1206 High Performance Low Pass 8W

LP1206A3600ASTR – SMD Termination



TYPICAL ELECTRICAL PERFORMANCE

P/N	I.Loss @ 3.6GHz	R.Loss @ 3.6GHz	Attenuation
LP1206A3600ASTR	0.7dB max.	-25dB	-30dB at 5.04GHz -35dB at 7.2GHz -25dB at 10.8GHz

[Click here to return to main table.](#)

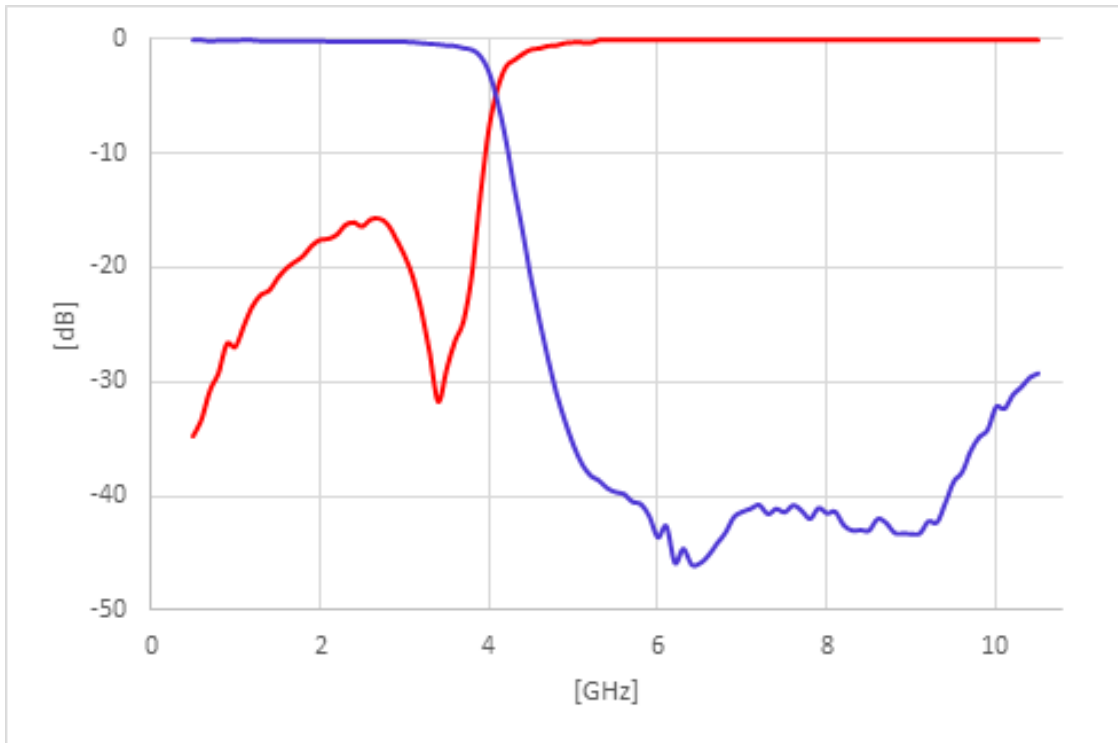

DIMENSIONS

(TOP VIEW)

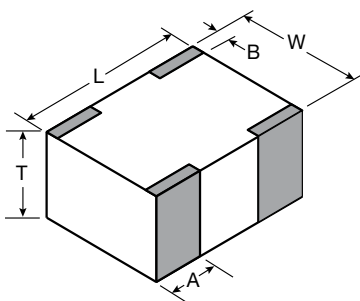

mm (inches)

L	3.08±0.1 (0.121±0.004)
W	1.60±0.1 (0.063±0.004)
T	0.87±0.1 (0.034±0.004)
A	0.61±0.25 (0.028±0.010)
B	0.35±0.15 (0.014±0.006)

RECOMMENDED PAD LAYOUT

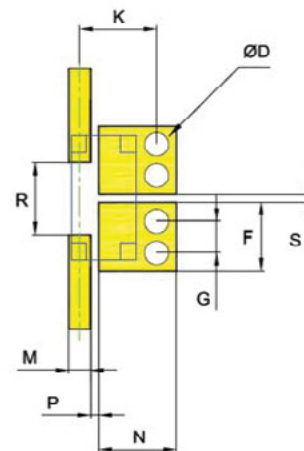

mm (inches)

F	1.70±0.05 (0.067±0.002)
G	0.78±0.05 (0.031±0.002)
K	1.91±0.10 (0.075±0.004)
M	0.54±0.025 (0.021±0.001)
N	1.93±0.05 (0.076±0.002)
P	0.21±0.04 (0.008±0.002)
R	1.80±0.04 (0.071±0.002)
S	0.20±0.04 (0.008±0.002)
D	0.60±0.10 (0.024±0.004)

TERMINAL AND LAYOUT (TOP VIEW)

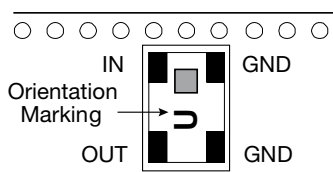

Thin-Film RF/Microwave Filters

1206 High Performance Low Pass 8W

LP1206A3800ASTR – SMD Termination



TYPICAL ELECTRICAL PERFORMANCE

P/N	I.Loss @ 3.6GHz	R.Loss @ 3.6GHz	Attenuation
LP1206A3800ASTR	0.8dB max.	-20dB	-35dB at 5.32GHz -28dB at 7.6GHz -33dB at 10GHz

[Click here to return to main table.](#)

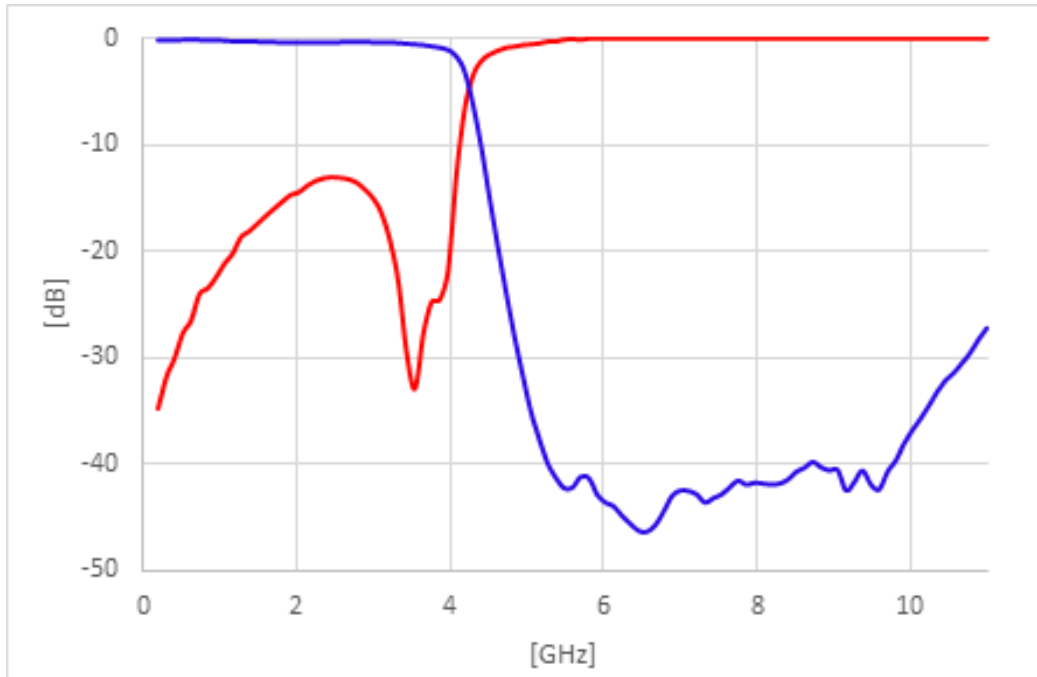

DIMENSIONS (TOP VIEW)

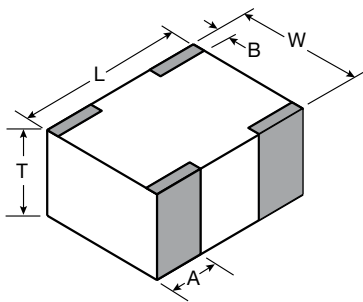

	mm (inches)
L	3.08±0.1 (0.121±0.004)
W	1.60±0.1 (0.063±0.004)
T	0.87±0.1 (0.034±0.004)
A	0.61±0.25 (0.028±0.010)
B	0.35±0.15 (0.014±0.006)

RECOMMENDED PAD LAYOUT

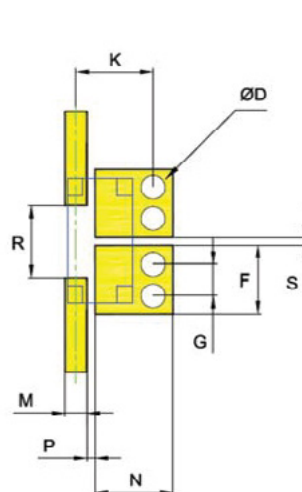

	mm
F	1.70±0.05 (0.067±0.002)
G	0.78±0.05 (0.031±0.002)
K	1.91±0.10 (0.075±0.004)
M	0.54±0.025 (0.021±0.001)
N	1.93±0.05 (0.076±0.002)
P	0.21±0.04 (0.008±0.002)
R	1.80±0.04 (0.071±0.002)
S	0.20±0.04 (0.008±0.002)
D	0.60±0.10 (0.024±0.004)

TERMINAL AND LAYOUT (TOP VIEW)

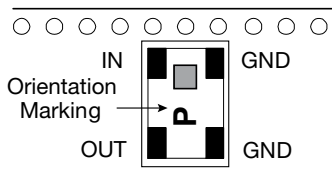



High Performance Low Pass Filters

2816 High Performance Low Pass 20W

Thin-Film RF/Microwave Filters

2816 High Performance Low Pass 20W

General Information

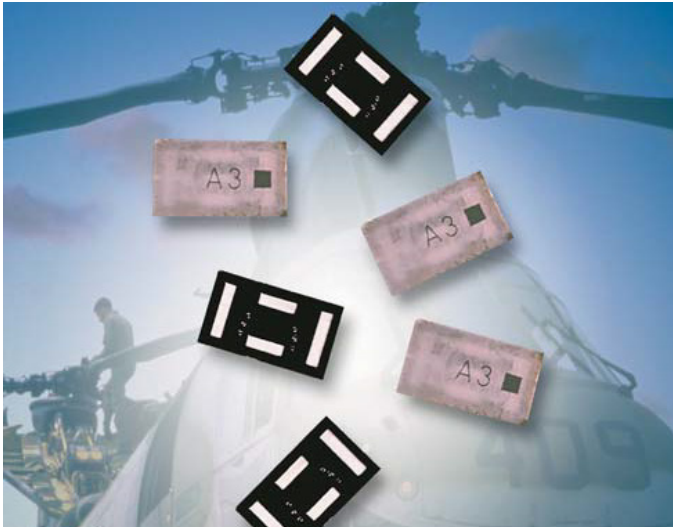

ITF TECHNOLOGY

The ITF LGA Filter is based on thin-film multilayer technology. The technology provides a miniature part with excellent high frequency performance and rugged construction for reliable automatic assembly.

The ITF Filter is offered in a variety of frequency bands compatible with various types of high frequency wireless systems.

FEATURES

- Small size: 7x4x1.2 (LxWxT)
- Frequency: 500-2500MHz
- Steep attenuation
- Characteristic impedance: 50Ω
- Operating/Storage temp: -40°C – +85°C
- Low profile
- Rugged construction
- Taped and reeled
- RoHS compliant

APPLICATIONS

- Mobile communications
- Satellite TV receivers
- GPS
- Vehicle location systems
- Wireless LAN's

HOW TO ORDER

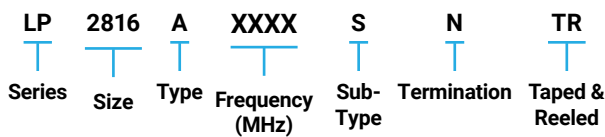

FINAL QUALITY INSPECTION

Finished parts are 100% tested for electrical parameters and visual/mechanical characteristics. Each production lot is evaluated on a sample basis for:

- Static Humidity: 85°C, 85% RH, 160 hours
- Endurance: 125°C, I_R, 4 hours

TERMINATION

Nickel/ Lead free Solder coating (Sn100) compatible with automatic soldering technologies: reflow, wave soldering, vapor phase and manual.

POWER RATING

20W Continuous

DIMENSIONS (BOTTOM VIEW): mm (inches)

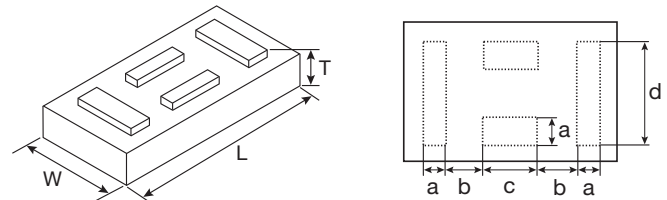

TERMINALS (TOP VIEW)

L	7.00±0.30 (0.276±0.012)	a	0.60±0.15 (0.024±0.006)
W	4.00±0.20 (0.157±0.008)	b	1.40±0.15 (0.055±0.006)
T	1.2 max (0.047 max)	c	2.00±0.15 (0.079±0.006)
		d	3.00±0.15 (0.118±0.006)

ELECTRICAL SPECIFICATIONS TABLE

Frequency [MHz]	Insertion Loss [dB]	Return Loss [dB]	Rejection [dB]	Rejection [dB]	Rejection [dB]
500	-0.9	-18	-35 dB @ 1000 MHz	-40 dB @ 1500 - 2500 MHz	----
512	-0.85	-18	-40 dB @ 720 MHz	-35 dB @ 1024 MHz	-50dB @ 1500 - 2500 MHz
520	-0.95	-18	-35 dB @ 1040 MHz	-40 dB @ 1500 - 2500 MHz	----
570	-0.7	-18	-35 dB @ 1140 MHz	-40 dB @ 1500 - 2500 MHz	----
600	-0.7	-18	-35 dB @ 1200 MHz	-40 dB @ 1500 - 2500 MHz	----
680	-0.7	-23	-36 dB @ 950 MHz	-40 dB @ 1360 - 2500 MHz	---
1300	-0.85	-15	-40 dB @ 850 MHz	-40 dB @ 2000 - 7000 MHz	-30 dB @ 7.0 - 10.0 GHz
1400	-0.75	-15	-35 dB @ 1960 MHz	-40 dB @ 2100 - 6000 MHz	-30 dB @ 6.0 - 9.0 GHz
1600	-0.8	-20	-45 dB @ 2240 MHz	-40 dB @ 2240 - 7500 MHz	-35 dB @ 7.5 - 10 GHz
1700	-0.52	-14	-30 dB @ 2380 MHz	-40 dB @ 2500 - 7000 MHz	-30 dB @ 7.0 - 10 GHz
1800	-0.75	-20	-20 dB @ 2520 MHz	-40 dB @ 2800 - 8500 MHz	-35 dB @ 8.5 - 10 GHz
1900	-0.8	-23	-35 dB @ 2660 MHz	-40 dB @ 3000 - 10000 MHz	-40 dB @ 720 MHz
2500	-0.8	-15	-35 dB @ 3500 MHz	-45 dB @ 5400 - 7500 MHz	-35dB @ 10 GHz

Click on frequency to see full specifications

Thin-Film RF/Microwave Filters

2816 High Performance Low Pass 20W

LP2816A0500SNTR – LGA Termination



TYPICAL ELECTRICAL PERFORMANCE

Parameter	Value	Unit	Notes
Fc	500	MHz	
Insertion Loss @500 MHz	-0.9	dB	Max.
R Loss @500MHz	-18	dB	
Rejection @1000MHz	-35	dB	Min.
Rejection @ 1500 - 2500 MHz	-40	dB	Min.
Power Handling	20	W	RF Continuous
Impedance	50	Ohm	
Operating Temp.	-40 to +85	°C	
Size	7x4x1.2mm		

[Click here to return to main table](#)

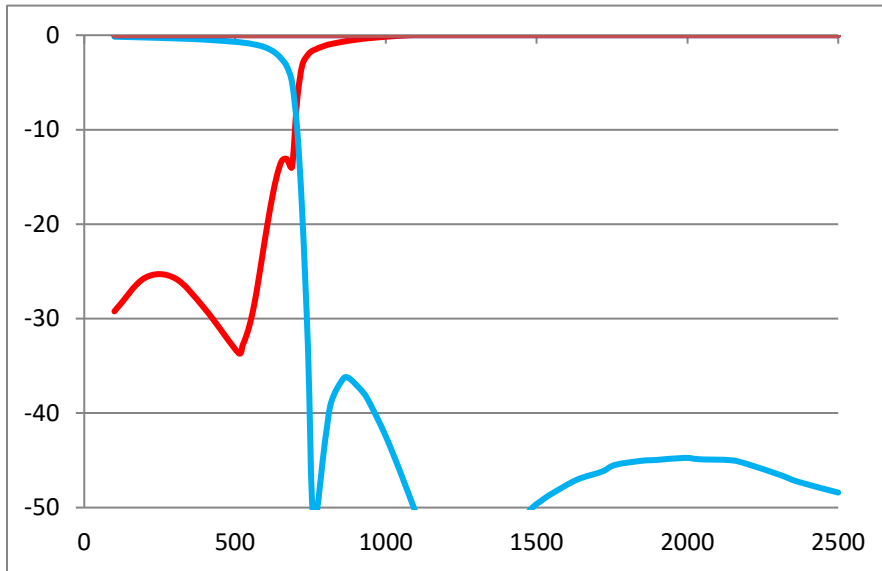

RECOMMENDED PAD LAYOUT

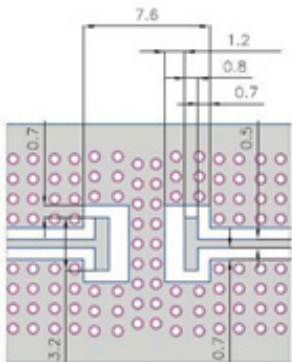

ORIENTATION MARKING CODE

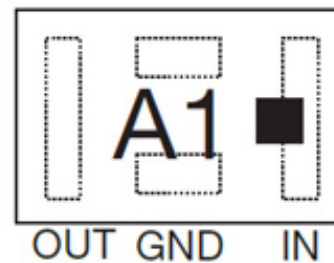

Thin-Film RF/Microwave Filters

2816 High Performance Low Pass 20W

LP2816A0512SNTR – LGA Termination



TYPICAL ELECTRICAL PERFORMANCE

Parameter	Value	Unit	Notes
Fc	512	MHz	
Insertion Loss @512 MHz	-0.85	dB	Max.
R Loss @512MHz	-18	dB	
Rejection @ 720 MHz	-40	dB	Min.
Rejection @1024 MHz	-35	dB	Min.
Rejection @ 1500 - 2500 MHz	-50	dB	Min.
Power Handling	20	W	RF Continuous
Impedance	50	Ohm	
Operating Temp.	-40 to +85	°C	
Size	7x4x1.2mm		

[Click here to return to main table](#)

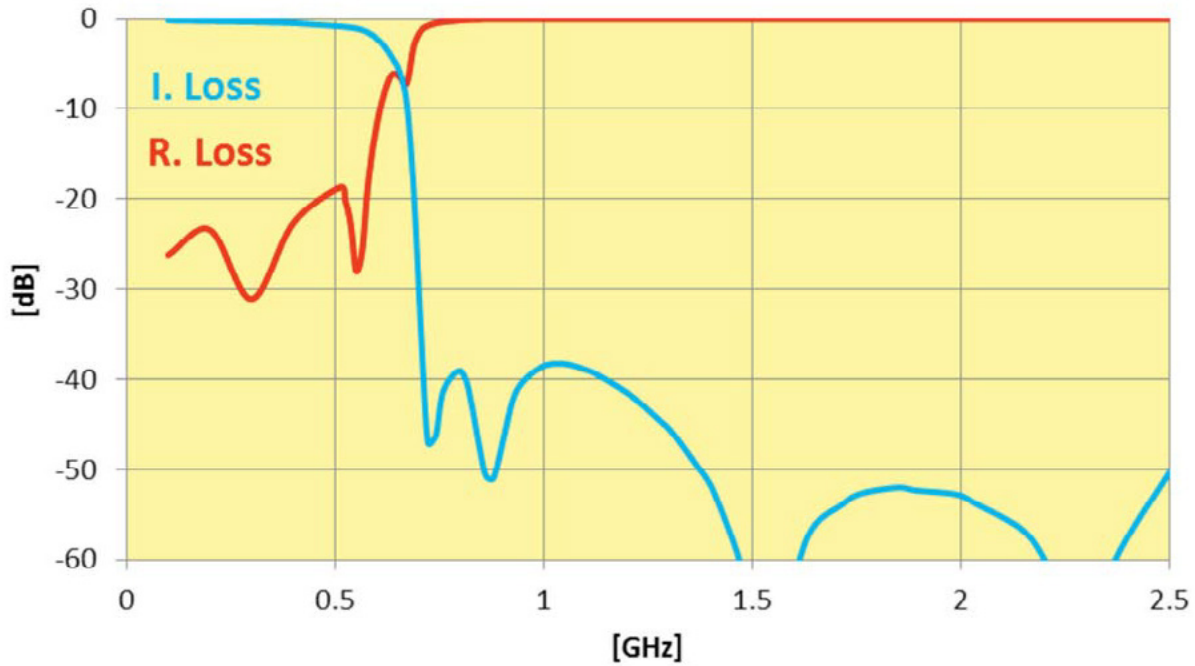

RECOMMENDED PAD LAYOUT

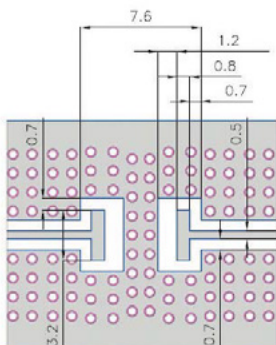

ORIENTATION MARKING CODE



Thin-Film RF/Microwave Filters

2816 High Performance Low Pass 20W

LP2816A0520SNTR – LGA Termination



TYPICAL ELECTRICAL PERFORMANCE

Parameter	Value	Unit	Notes
Fc	520	MHz	
Insertion Loss @520 MHz	-0.95	dB	Max.
R Loss @ 520MHz	-18	dB	
Rejection @1040 MHz	-35	dB	Min.
Rejection @ 1500 - 2500 MHz	-40	dB	Min.
Power Handling	20	W	RF Continuous
Impedance	50	Ohm	
Operating Temp.	-40 to +85	°C	
Operating Temp.	-40 to +85	°C	
Size	7x4x1.2mm		

[Click here to return to main table](#)

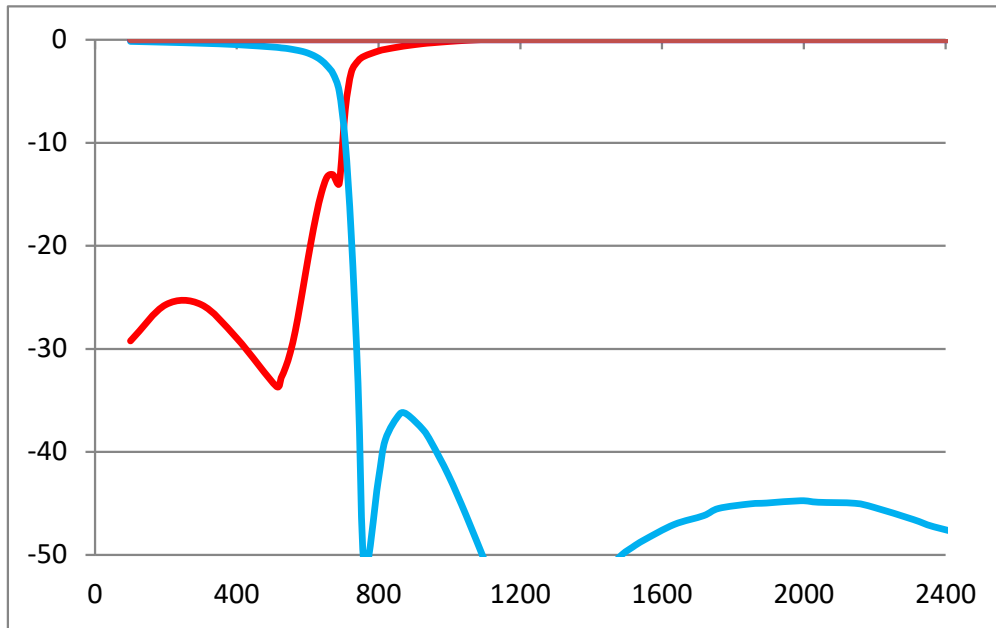

RECOMMENDED PAD LAYOUT

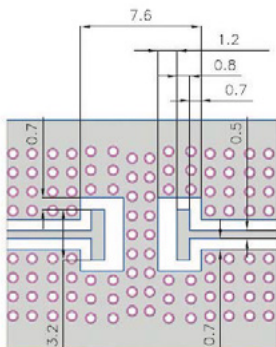

ORIENTATION MARKING CODE



Thin-Film RF/Microwave Filters

2816 High Performance Low Pass 20W

LP2816A0570SNTR – LGA Termination



TYPICAL ELECTRICAL PERFORMANCE

Parameter	Value	Unit	Notes
Fc	570	MHz	
Insertion Loss @570MHz	-0.85	dB	Max.
R Loss @570MHz	-18	dB	
Rejection @1140 MHz	-35	dB	Min.
Rejection @ 1500 - 2500 MHz	-40	dB	Min.
Power Handling	20	W	RF Continuous
Impedance	50	Ohm	
Operating Temp.	-40 to +85	°C	
Size	7x4x1.2mm		

[Click here to return to main table](#)

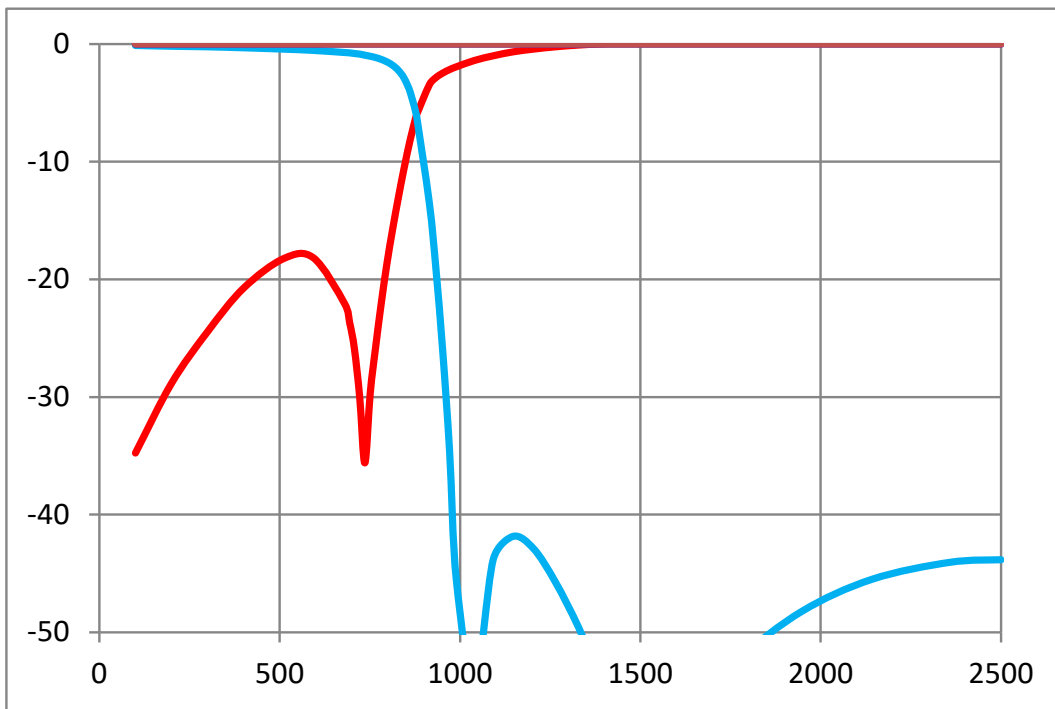

RECOMMENDED PAD LAYOUT

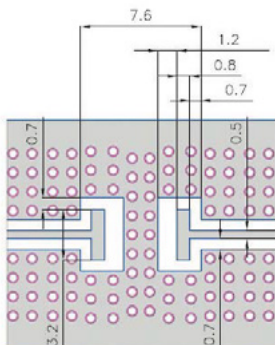

ORIENTATION MARKING CODE



Thin-Film RF/Microwave Filters

2816 High Performance Low Pass 20W

LP2816A0600SNTR – LGA Termination



TYPICAL ELECTRICAL PERFORMANCE

Parameter	Value	Unit	Notes
Fc	600	MHz	
Insertion Loss @600MHz	-0.85	dB	Max.
R Loss @ 600 MHz	-18	dB	
Rejection @1200 MHz	-35	dB	Min.
Rejection @ 1500 - 2500 MHz	-40	dB	Min.
Power Handling	20	W	RF Continuous
Impedance	50	Ohm	
Operating Temp.	-40 to +85	°C	
Size	7x4x1.2mm		

[Click here to return to main table](#)

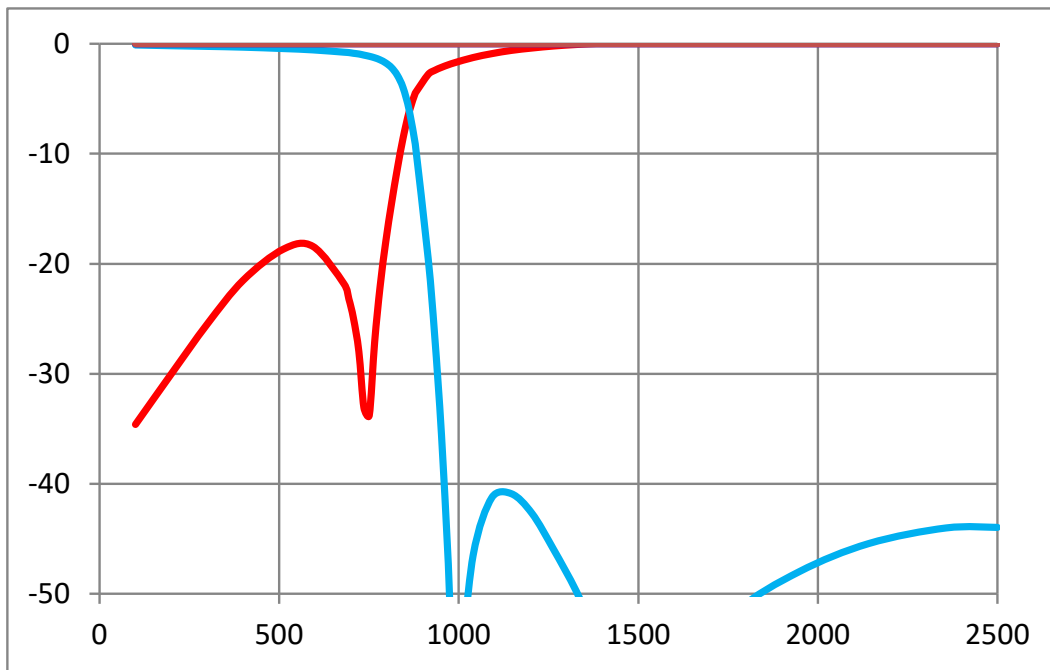

RECOMMENDED PAD LAYOUT

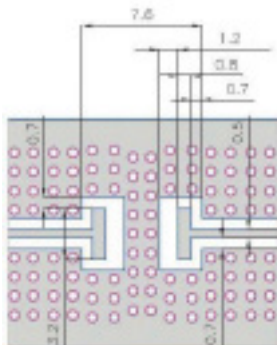

ORIENTATION MARKING CODE

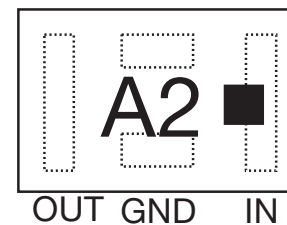

The Important Information/Disclaimer is incorporated in the catalog where these specifications came from or available online at www.kyocera-avx.com/disclaimer/ by reference and should be reviewed in full before placing any order.

042222

Thin-Film RF/Microwave Filters

2816 High Performance Low Pass 20W

LP2816A0680SNTR – LGA Termination



TYPICAL ELECTRICAL PERFORMANCE

Parameter	Value	Unit	Notes
Fc	680	MHz	
Rejection @950MHz	-36	dB	Min.
Rejection 1.36GHz-2.5GHz	-40	dB	Min.
Insertion Loss @680MHz	-0.7	dB	Max.
R Loss @680MHz	-23	dB	
Power Handling	20	W	RF Continuous
Impedance	50	Ohm	
Operating Temp.	-40 to +85	°C	
Size	7x4x1.2mm		

[Click here to return to main table](#)

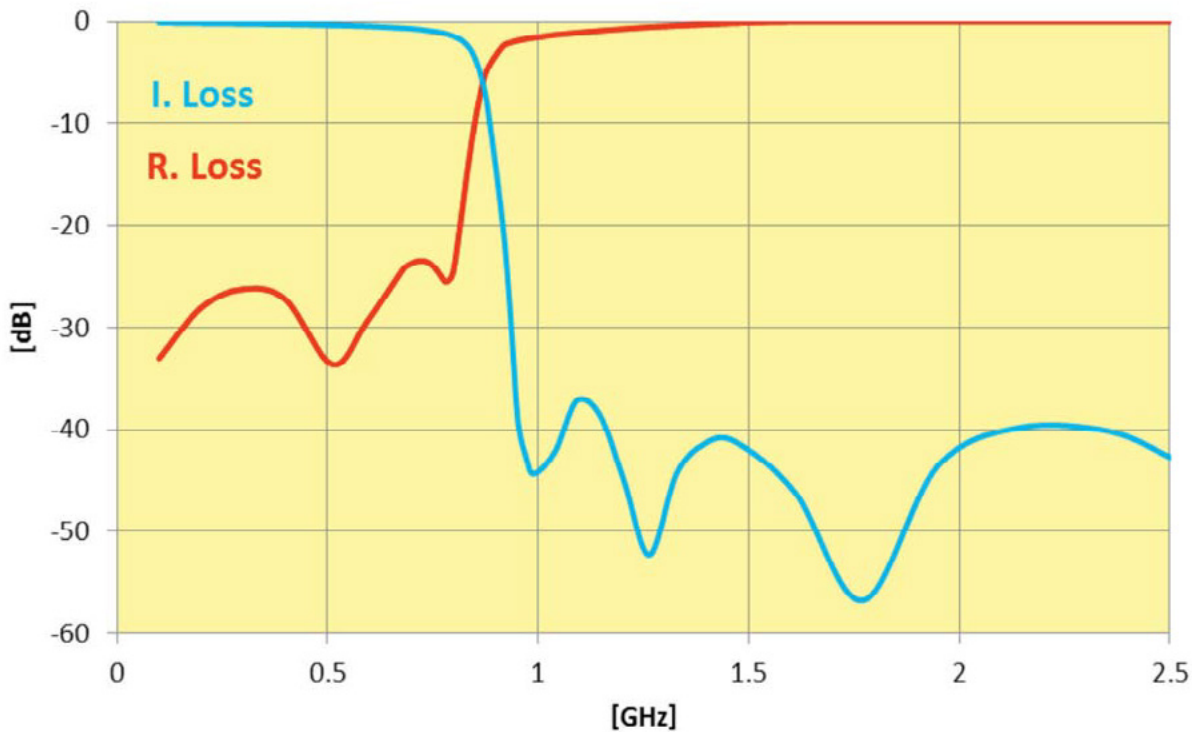

RECOMMENDED PAD LAYOUT

ORIENTATION MARKING CODE

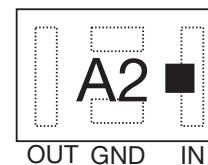
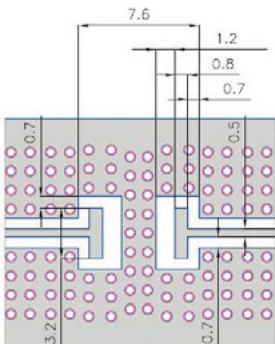

Thin-Film RF/Microwave Filters

2816 High Performance Low Pass 20W

LP2816A1300SNTR – LGA Termination



TYPICAL ELECTRICAL PERFORMANCE

Parameter	Value	Unit	Notes
Fc	1300	MHz	
Rejection @1.82GHz	-40	dB	Min.
Rejection 2GHz-7GHz	-40	dB	Min.
Rejection 7GHz-10GHz	-30	dB	Min.
Insertion Loss @1300MHz	-0.85	dB	Max.
Return Loss @1300MHz	-15	dB	Typ.
Power Handling	20	W	RF Continuous
Impedance	50	Ohm	
Operating Temp.	-40 to +85	°C	
Size	7x4x1.2mm		

[Click here to return to main table](#)

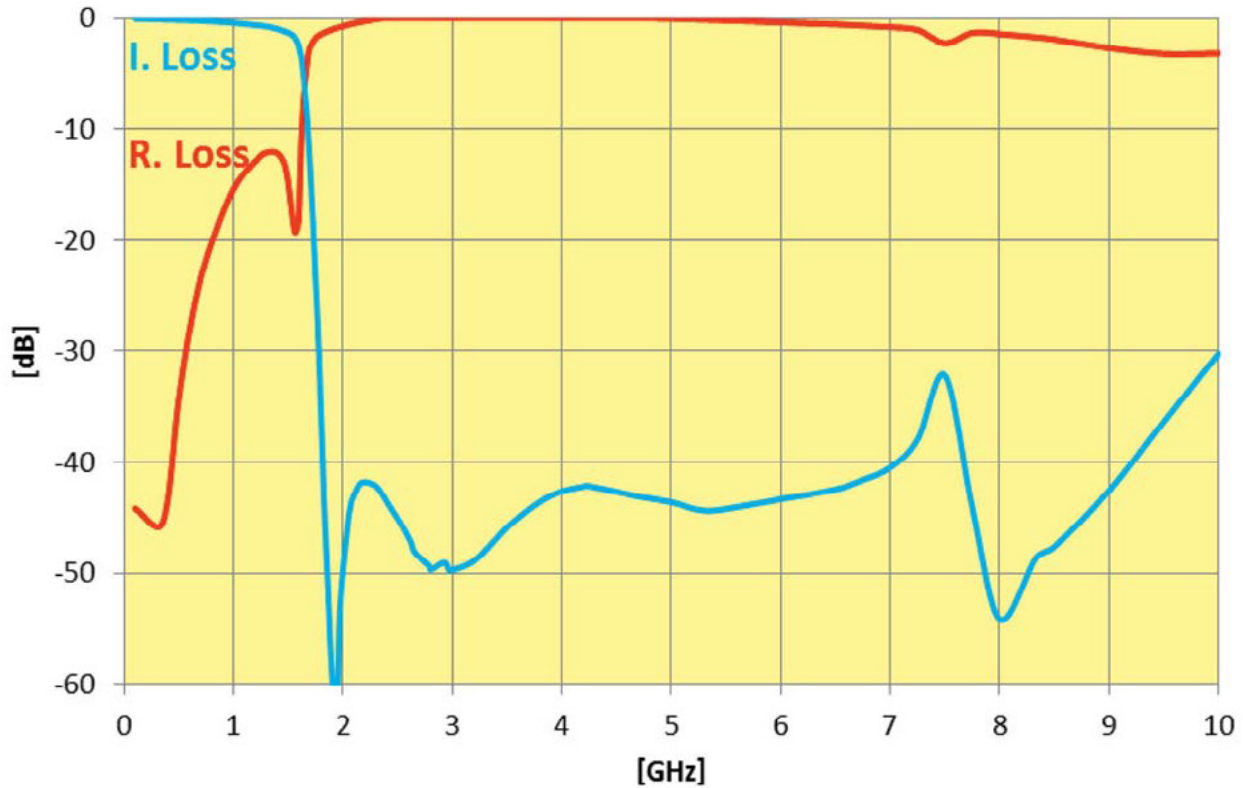

RECOMMENDED PAD LAYOUT

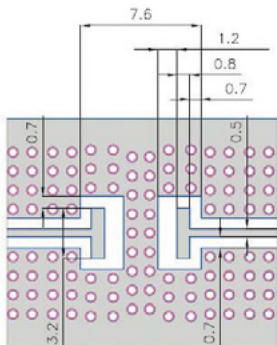

ORIENTATION MARKING CODE



The Important Information/Disclaimer is incorporated in the catalog where these specifications came from or available online at www.kyocera-avx.com/disclaimer/ by reference and should be reviewed in full before placing any order.

042222

Thin-Film RF/Microwave Filters

2816 High Performance Low Pass 20W

LP2816A1400SNTR – LGA Termination



TYPICAL ELECTRICAL PERFORMANCE

Parameter	Value	Unit	Notes
Fc	1400	MHz	
Rejection @1960MHz	-35	dB	Min.
Rejection 2.1GHz-6GHz	-40	dB	Min.
Rejection 6GHz-9GHz	-30	dB	Min.
Insertion Loss @1400MHz	-0.75	dB	Max.
R Loss @1400MHz	-15	dB	
Power Handling	20	W	RF Continuous
Impedance	50	Ohm	
Operating Temp.	-40 to +85	°C	
Size	7x4x1.2mm		

[Click here to return to main table](#)

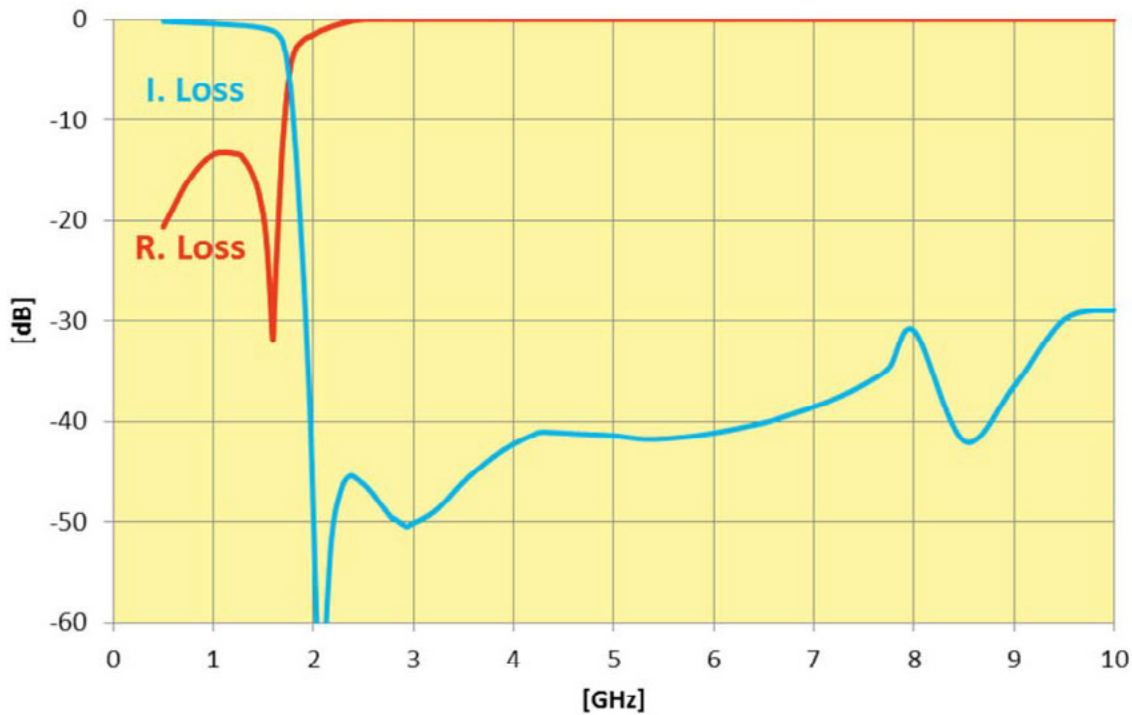

RECOMMENDED PAD LAYOUT

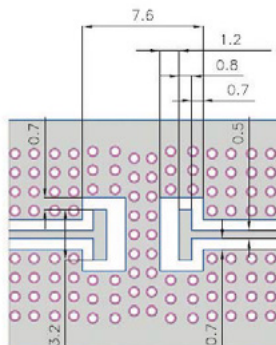

ORIENTATION MARKING CODE



Thin-Film RF/Microwave Filters

2816 High Performance Low Pass 20W

LP2816A1600SNTR – LGA Termination



TYPICAL ELECTRICAL PERFORMANCE

Parameter	Value	Unit	Notes
Fc	1600	MHz	
Rejection @2.24GHz	-45	dB	Min.
Rejection 2.24GHz-7.5GHz	-40	dB	Min.
Rejection 7.5GHz-10GHz	-35	dB	Min.
Insertion Loss @1600MHz	-0.8	dB	Max.
Return Loss @1600MHz	-20	dB	Typ.
Power Handling	20	W	RF Continuous
Impedance	50	Ohm	
Operating Temp.	-40 to +85	°C	
Size	7x4x1.2mm		

[Click here to return to main table](#)

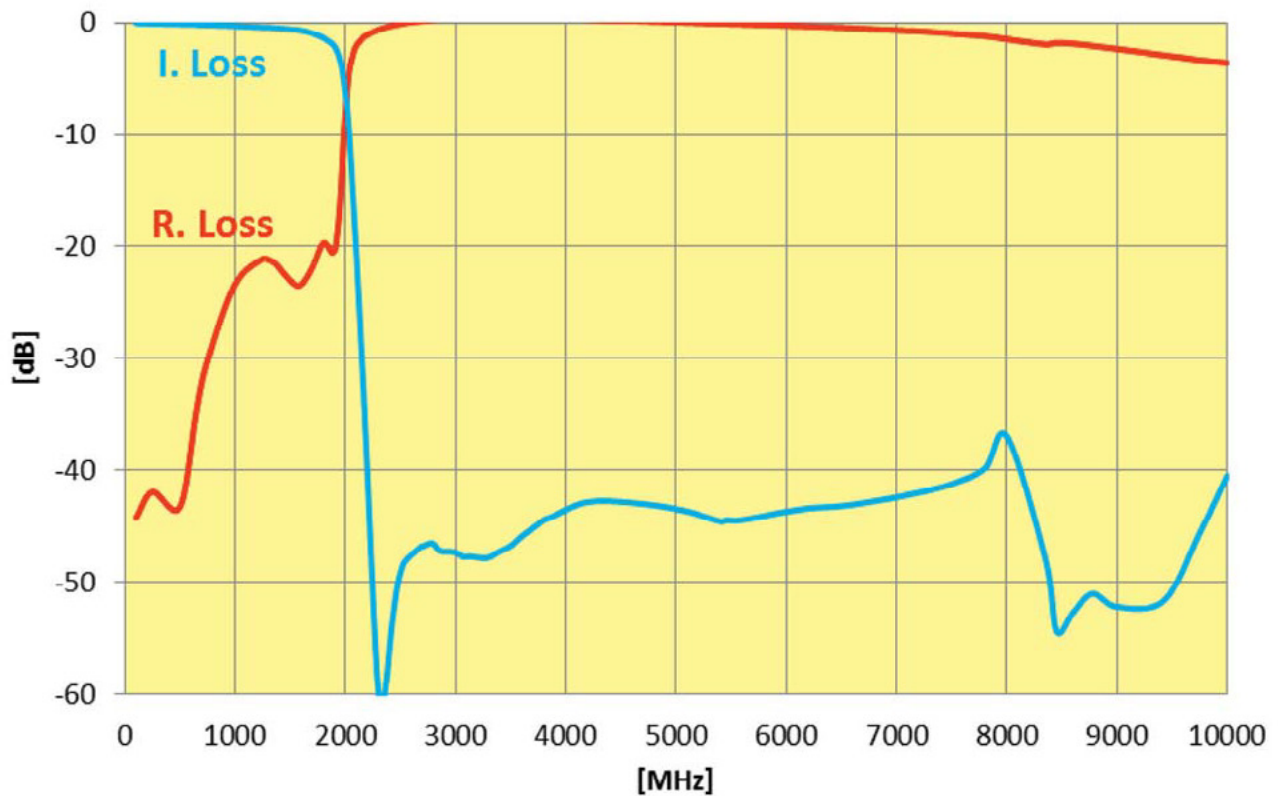

RECOMMENDED PAD LAYOUT

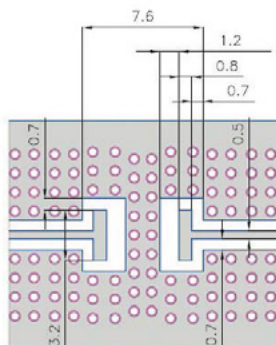

ORIENTATION MARKING CODE



The Important Information/Disclaimer is incorporated in the catalog where these specifications came from or available online at www.kyocera-avx.com/disclaimer/ by reference and should be reviewed in full before placing any order.

042222

Thin-Film RF/Microwave Filters

2816 High Performance Low Pass 20W

LP2816A1700SNTR – LGA Termination



TYPICAL ELECTRICAL PERFORMANCE

Parameter	Value	Unit	Notes
Fc	1700	MHz	
Rejection @2.38GHz	-30	dB	Min.
Rejection 2.5GHz-7GHz	-45	dB	Min.
Rejection 7GHz-10GHz	-30	dB	Min.
Insertion Loss @1700MHz	-0.85	dB	Max.
Return Loss @1700MHz	-14	dB	Typ.
Power Handling	20	W	RF Continuous
Impedance	50	Ohm	
Operating Temp.	-40 to +85	°C	
Size	7x4x1.2mm		

[Click here to return to main table](#)

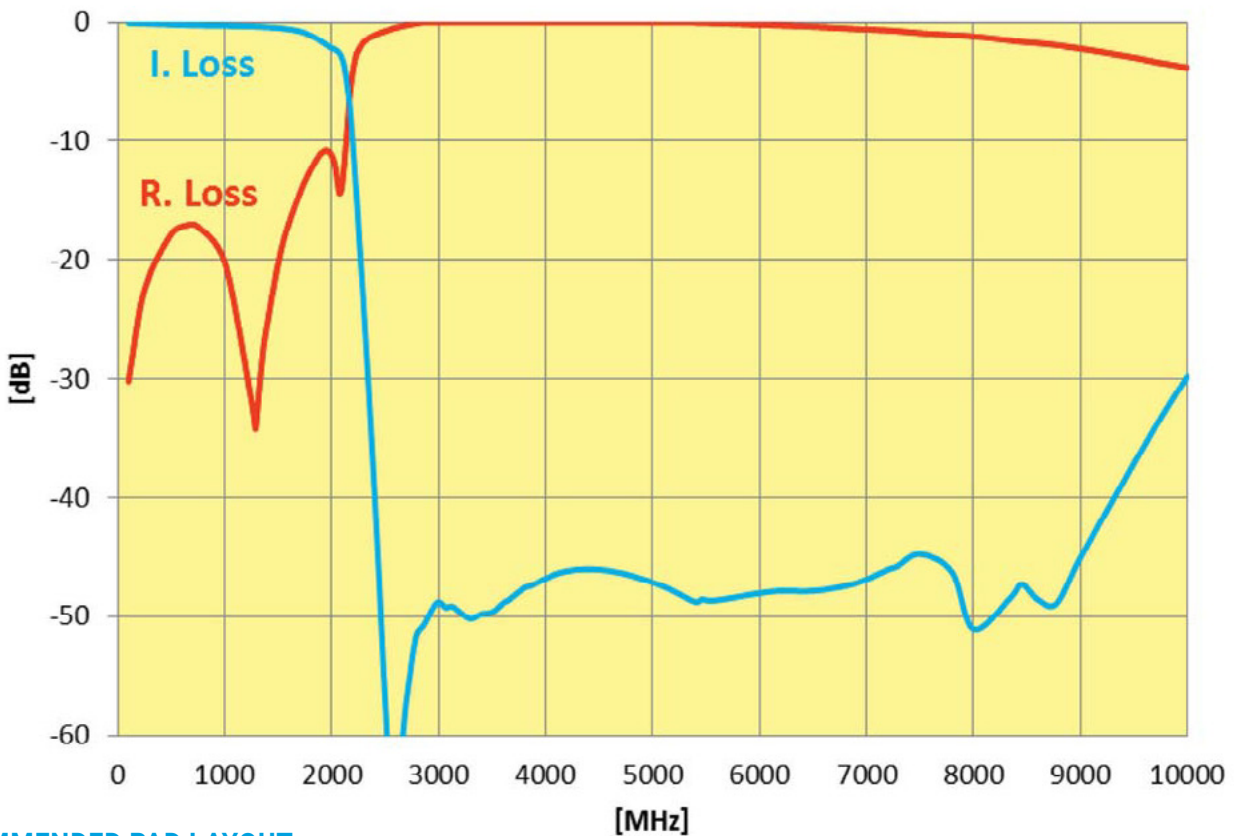

RECOMMENDED PAD LAYOUT

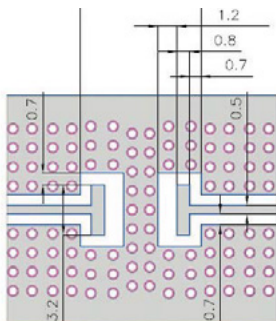

ORIENTATION MARKING CODE



Thin-Film RF/Microwave Filters

2816 High Performance Low Pass 20W

LP2816A1800SNTR – LGA Termination



TYPICAL ELECTRICAL PERFORMANCE

Parameter	Value	Unit	Notes
Fc	1800	MHz	
Rejection @2.52GHz	-19	dB	Min.
Rejection 2.8GHz-8.5GHz	-40	dB	Min.
Rejection 8.5GHz-10GHz	-35	dB	Min.
Insertion Loss @1800MHz	-0.75	dB	Max.
Return Loss @1800MHz	-20	dB	Typ.
Power Handling	20	W	RF Continuous
Impedance	50	Ohm	
Operating Temp.	-40 to +85	°C	
Size	7x4x1.2mm		

[Click here to return to main table](#)

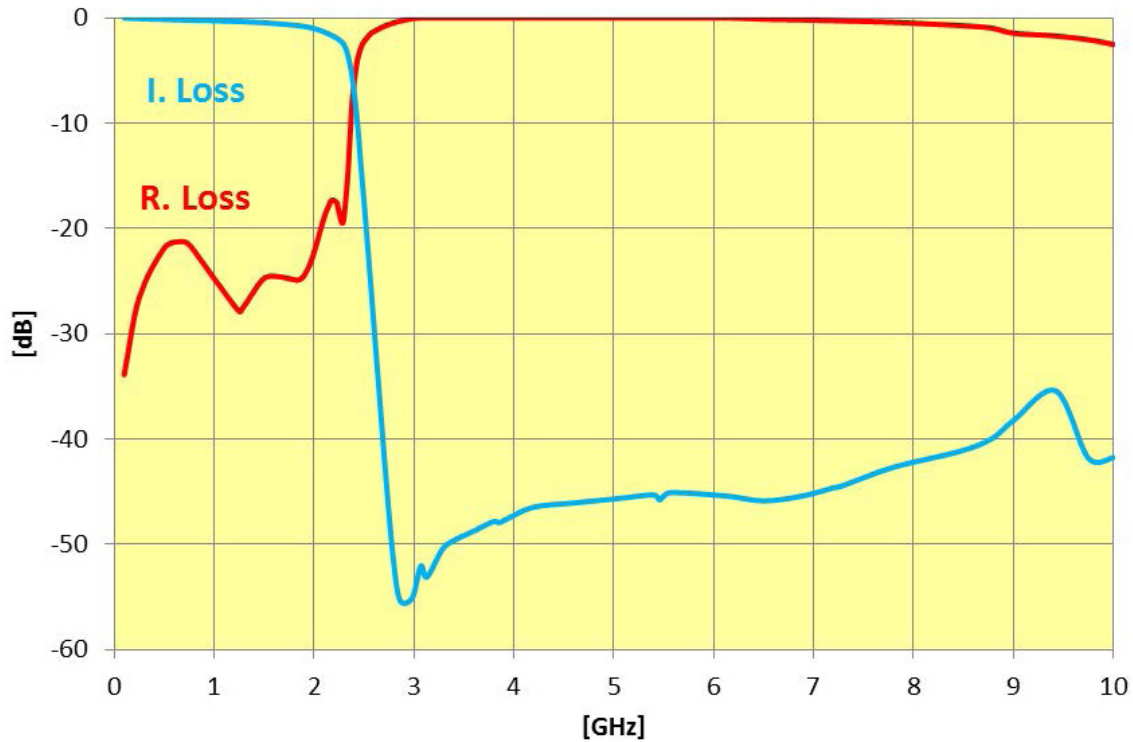

RECOMMENDED PAD LAYOUT

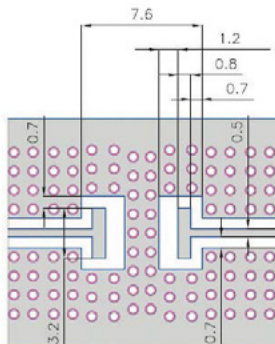

ORIENTATION MARKING CODE



Thin-Film RF/Microwave Filters

2816 High Performance Low Pass 20W

LP2816A1900SNTR – LGA Termination



TYPICAL ELECTRICAL PERFORMANCE

Parameter	Value	Unit	Notes
Fc	1900	MHz	
Rejection @2.66GHz	-35	dB	Min.
Rejection 2.5GHz-10GHz	-40	dB	Min.
Insertion Loss @1900MHz	-0.8	dB	Max.
Return Loss @1900MHz	-23	dB	Typ.
Power Handling	20	W	RF Continuous
Impedance	50	Ohm	
Operating Temp.	-40 to +85	°C	
Size	7x4x1.2mm		

[Click here to return to main table](#)

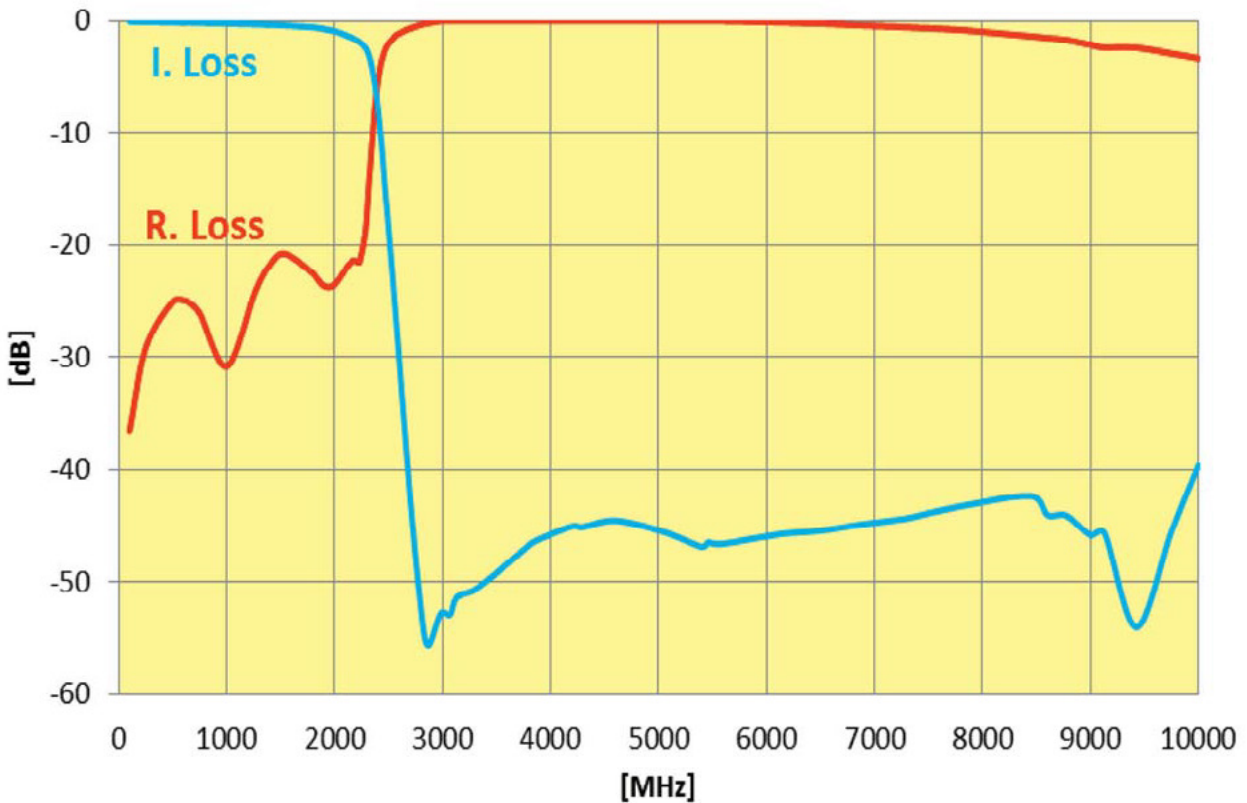

RECOMMENDED PAD LAYOUT

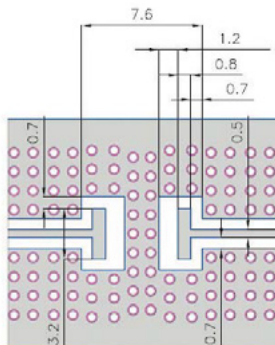

ORIENTATION MARKING CODE



Thin-Film RF/Microwave Filters

2816 High Performance Low Pass 20W

LP2816A2500SNTR – LGA Termination



TYPICAL ELECTRICAL PERFORMANCE

Parameter	Value	Unit	Notes
Fc	2500	MHz	
Rejection @3500MHz	-35	dB	Min.
Insertion Loss @2500MHz	-0.8	dB	Max.
R Loss @2500MHz	-15	dB	
Rejection 5GHz	-45	dB	Min.
Rejection 7.5GHz	-40	dB	Min.
Rejection 10GHz	-35	dB	Min.
Power Handling	20	W	RF Continuous
Impedance	50	Ohm	
Operating Temp.	-40 to +85	degC	
Size	7x4x1.2mm		

[Click here to return to main table](#)

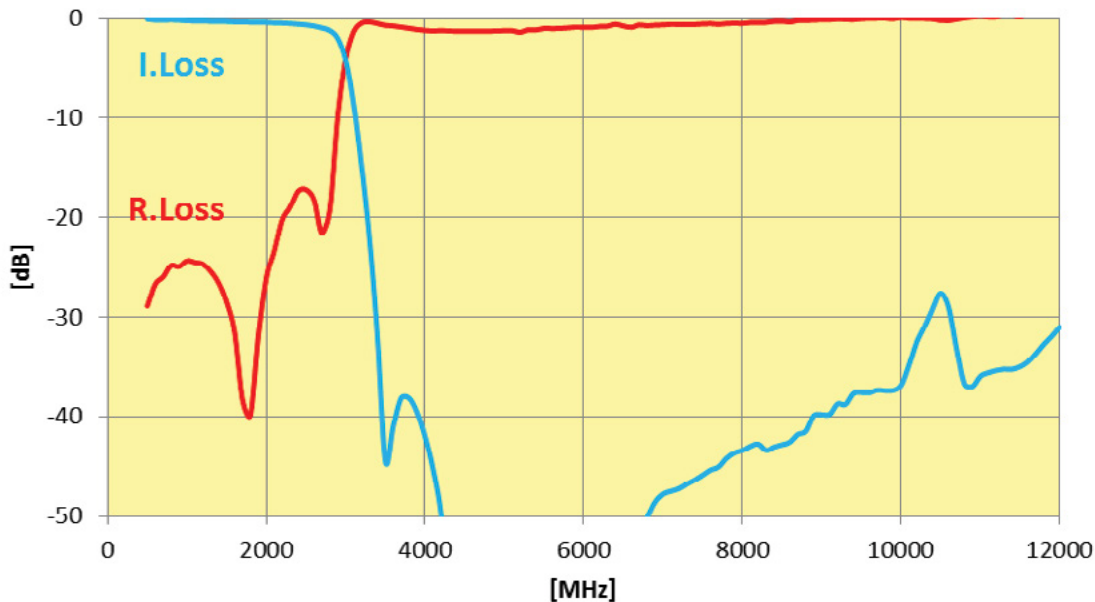

RECOMMENDED PAD LAYOUT

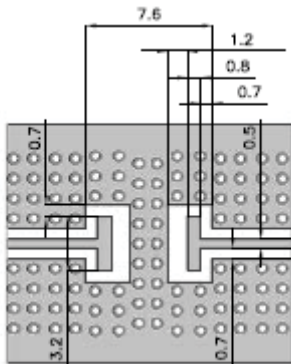

ORIENTATION MARKING CODE

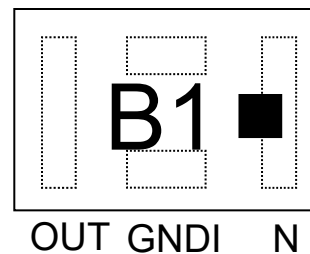

Thin-Film RF/Microwave Filters

2816 High Performance Low Pass 20W

LP2816A2500SNTR – LGA Termination

TAPE & REEL

All tape and reel specifications are in compliance with EIA 481-1-A (equivalent to IEC 286 part 3).

- 12mm carrier
- Reeled quantities: Reels of 2,000 per 7" reel

REEL DIMENSIONS: millimeters

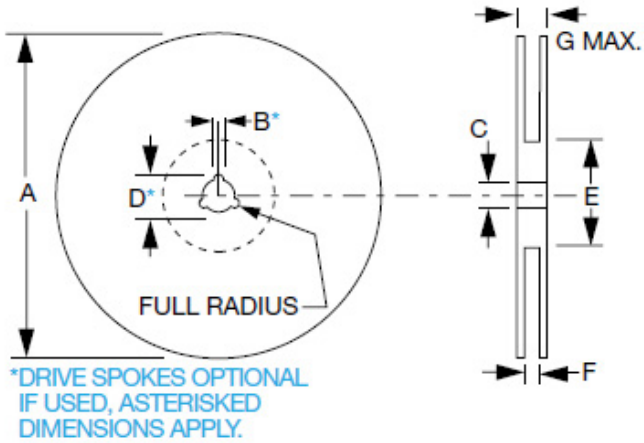

A	B	C	D	E	F	G
180±1.0	1.5 min.	13±0.2	20.2 min.	50 min.	13.6±0.1	16.6

CARRIER

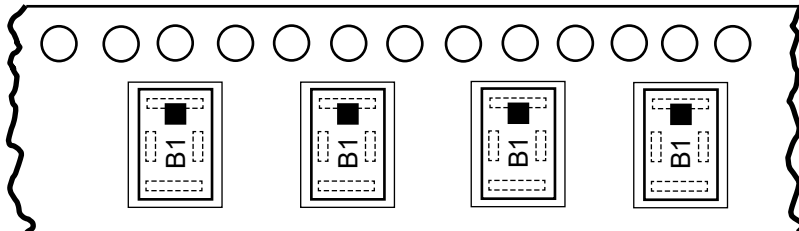



High Performance Band Pass Filters

BP0805 Band Pass Filter SMD 5W

Thin-Film RF/Microwave Filters

BP0805 Band Pass Filter SMD 5W

General Information

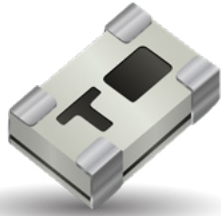

ITF TECHNOLOGY

The BP0805 Band Pass Filter is based on thin-film multilayer technology. The technology provides a miniature part with excellent high frequency performance and rugged construction for reliable automatic assembly.

The ITF Filter is offered in a variety of frequency bands compatible with various types of high frequency wireless systems.

FEATURES

- Small size: 0805
- Characteristic impedance: 50Ω
- Operating / Storage temp: -40°C – +105°C
- Low profile
- Rugged construction
- Taped and reeled
- RoHS compliant

APPLICATIONS

- 5G / 6G / UWB Applications
- Base Stations
- Mobile communications
- Satellite TV receivers
- GPS
- Vehicle location systems
- Wireless LAN's

HOW TO ORDER

BP	0805	A	XXXX	A	S	TR
Series	Case Size	Type	Frequency (MHz)	Sub-Type	Termination	Taped & Reeled

FINAL QUALITY INSPECTION

Finished parts are 100% tested for electrical parameters and visual/ mechanical characteristics. Each production lot is evaluated on a sample basis for:

- Static Humidity: 85°C, 85% RH, 160 hours
- Endurance : 125°C, IR, 4 hours

TERMINATION

Nickel/ Lead free Solder coating (Sn100) compatible with automatic soldering technologies: reflow, wave soldering, vapor phase and manual.

DIMENSIONS (TOP VIEW)

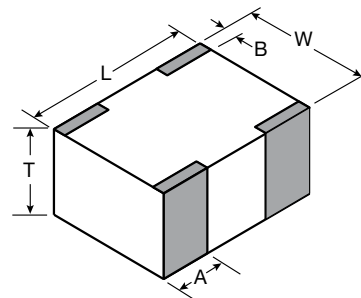

mm (inches)

L	2.03±0.1 (0.080±0.004)
W	1.55±0.1 (0.061±0.004)
T	0.80±0.1 (0.032±0.004)
A	0.56±0.25 (0.022±0.010)
B	0.35±0.15 (0.014±0.006)

ELECTRICAL SPECIFICATIONS TABLE

Part Number	Passband			Stopband Rejection (GHz)										Continuous Power	
	Frequency	I.L	R.L	Low Band		High Band									
				Band	Rejection	Band	Rejection	Band	Rejection	Band	Rejection	Band	Rejection		
				(MHz)	dB (max)	dB (Typ)	MHz	dB	MHz	dB	MHz	dB	MHz		dB
BP0805A1308ASTR	1220-1420	-2.0	-12	760-945	-16	2920-3105	-30	--	--	--	--	--	--	--	5W
BP0805A1457ASTR	1447-1467	-1.5	-11	DC-500	-30	500-960	-20	2110-2400	-25	2500-3600	-30	5150-6000	-19		
BP0805A1795ASTR	1785 - 1805	-1.8	-15	869-894	-30	925-960	-20	2300-2400	-30	2496-3600	-25	5150-5925	-25		
BP0805A2065ASTR	1930-2200	-1.3	-12	DC-1000	-20	4000-5000	-25	5000-6000	-30	---	---	---	---		
BP0805A2160ASTR	1960-2360	-0.85	-18	DC-440	-59	4320	-42	6480	-38	---	---	---	---		
BP0805A3500ASTR	3400-3600	-1.3	-15	DC-2000	-20	5250-7000	-25	7000-9000	-15	9000-10500	-10	---	---		
BP0805A3600ASTR	3500-3700	-1.3	-15	DC-2000	-30	5300-7200	-25	7200-11000	-10	---	--	---	---		
BP0805A3700ASTR	3600-3800	-1.3	-15	DC-2000	-30	5300-7400	-25	7400-11500	-10	----	---	---	---		
BP0805A3900ASTR	3600-4200	-2.5	-18	DC-3000	-10	5100-6550	-22	6550-10000	-25	----	---	---	---		
BP0805A4050ASTR	4000-4100	-1.3	-18	DC-2000	-25	6000-8000	-20	10000-12000	-12	----	---	---	---		
BP0805A4320ASTR	4120-4520	-1.2	-15	DC-2160	-45	6480	-39	8640	-44	--	--	---	---		
BP0805A7250ASTR	6625-7875	-1.5	-12	DC-5400	-25	10000-15000	-25	----	-	-	-	---	---		

Click on part number to see full specifications

Custom Band Pass Filters are Available Per Request

Thin-Film RF/Microwave Filters

BP0805 Band Pass Filter SMD 5W

BP0805A1308ASTR

TYPICAL ELECTRICAL PERFORMANCE

Description	Value
Center frequency	1308 MHz
Impedance	50 Ohm
Band	1220-1420 MHz
I. loss at center frequency	-1.2dB max.
In-band insertion loss flatness	-0.8dB
In-band return loss	-12dB
Rejection in [760-945 MHz]	-16dBc.
Rejection in [2920-3105 MHz]	-30dBc
Power handling (CW)	5W

[Click here to return to main table](#)

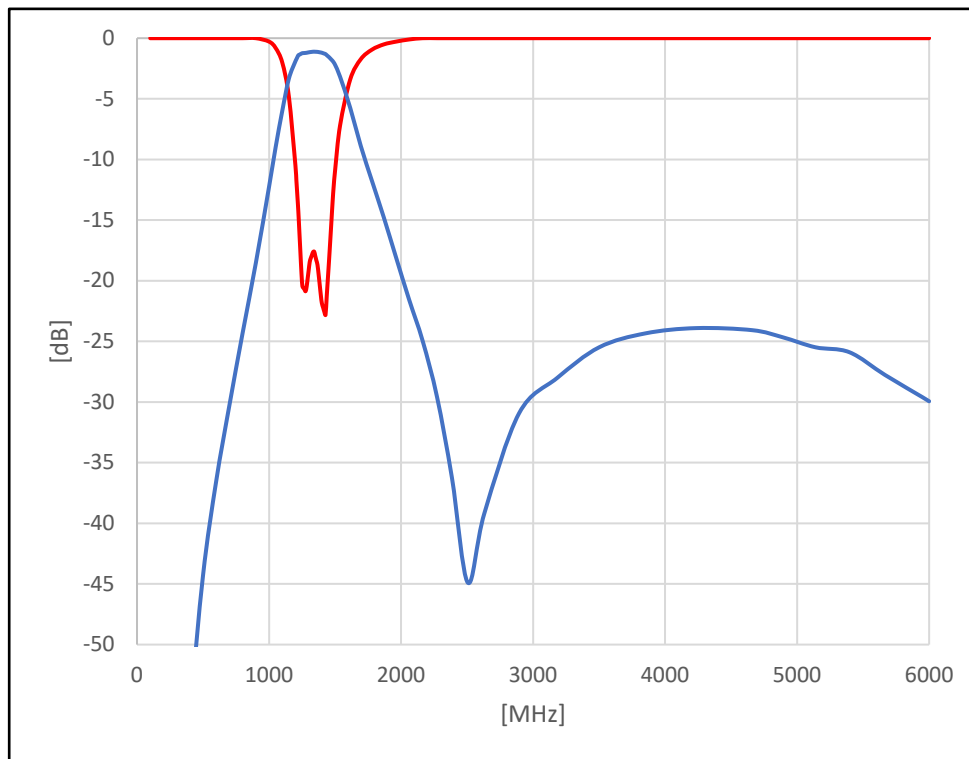

RECOMMENDED PAD LAYOUT

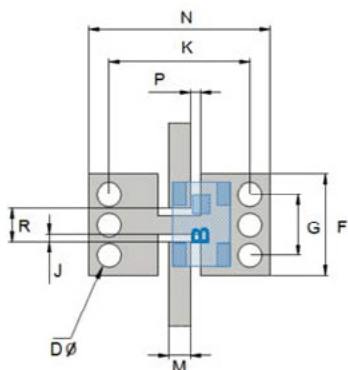

mm

F	2.5±0.05
G	1.5±0.05
J	0.19±0.05
K	3.48±0.05
M	0.54±0.25
N	4.48±0.05
P	0.25±0.05
R	0.85±0.05
D	0.6±0.05

TERMINALS AND LAYOUT: (Top View)

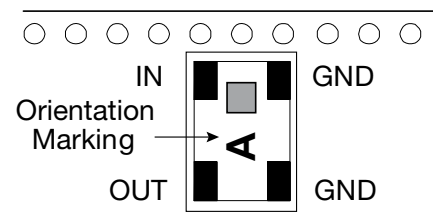

Thin-Film RF/Microwave Filters

BP0805 Band Pass Filter SMD 5W

BP0805A1457ASTR

TYPICAL ELECTRICAL PERFORMANCE

Description	Value
Center frequency	1457 MHz
Impedance	50 Ohm
Band	1447-1467 MHz
I. loss 1447-1467 MHz	-1.5dB max.
In-band VSWR (return loss)	< -1.8 (-11dB)
Rejection 925-960 MHz	>= -20dB
Rejection in 2110-2170 MHz	>= -25dB
Rejection in 2300-2400 MHz	>= -25dB
Rejection in 2500-2690 MHz	>= -30dB
Rejection 3400-3600 MHz	>= -30dB
Rejection 5150-5925 MHz	>= -19dB
Power handling (CW)	5W

[Click here to return to main table](#)

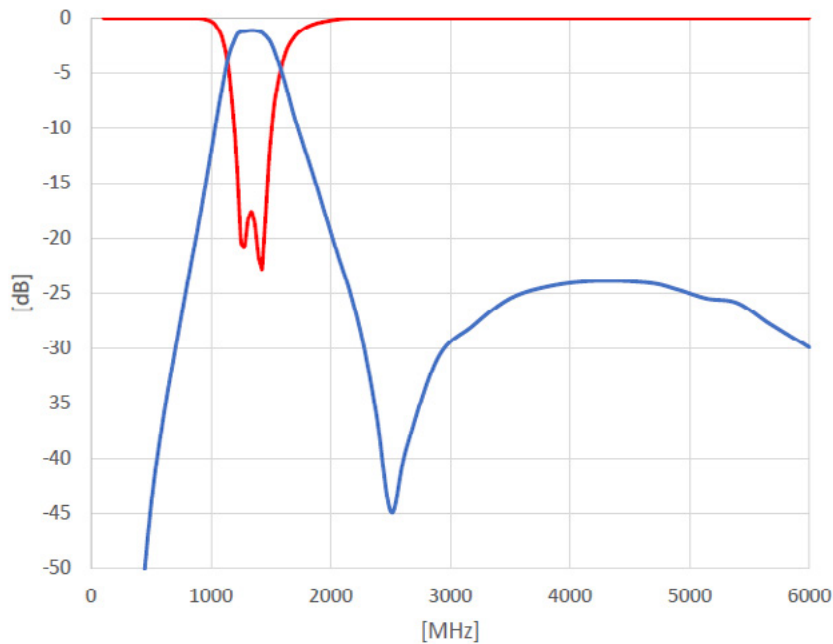

RECOMMENDED PAD LAYOUT: (mm)

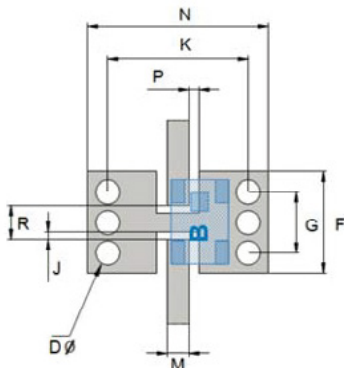

F	2.5±0.05
G	1.5±0.05
J	0.19±0.05
K	3.48±0.05
M	0.54±0.25
N	4.48±0.05
P	0.25±0.05
R	0.85±0.05
D	0.6±0.05

TERMINALS AND LAYOUT: (Top View)

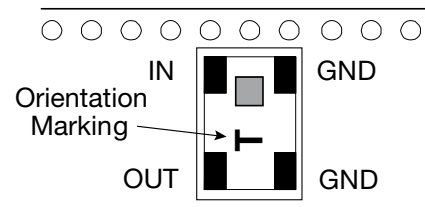

Thin-Film RF/Microwave Filters

BP0805 Band Pass Filter SMD 5W

BP0805A1795ASTR

TYPICAL ELECTRICAL PERFORMANCE

Description	Value
Center frequency	1795 MHz
Impedance	50 Ohm
Band	1785-1805 MHz
I. loss in band	-1.8dB max.
Return loss in band	-15dB
Rejection in [869~894 MHz]	-30dB min.
Rejection in [925~960 MHz]	-30dB min
Rejection in [2300~2400 MHz]	-30dB min
Rejection in [2496~2690 MHz]	-30dB
Rejection in [3400~3600 MHz]	-30dB
Rejection in [5150~5925 MHz]	-30dB
Power handling (CW)	5W

[Click here to return to main table](#)

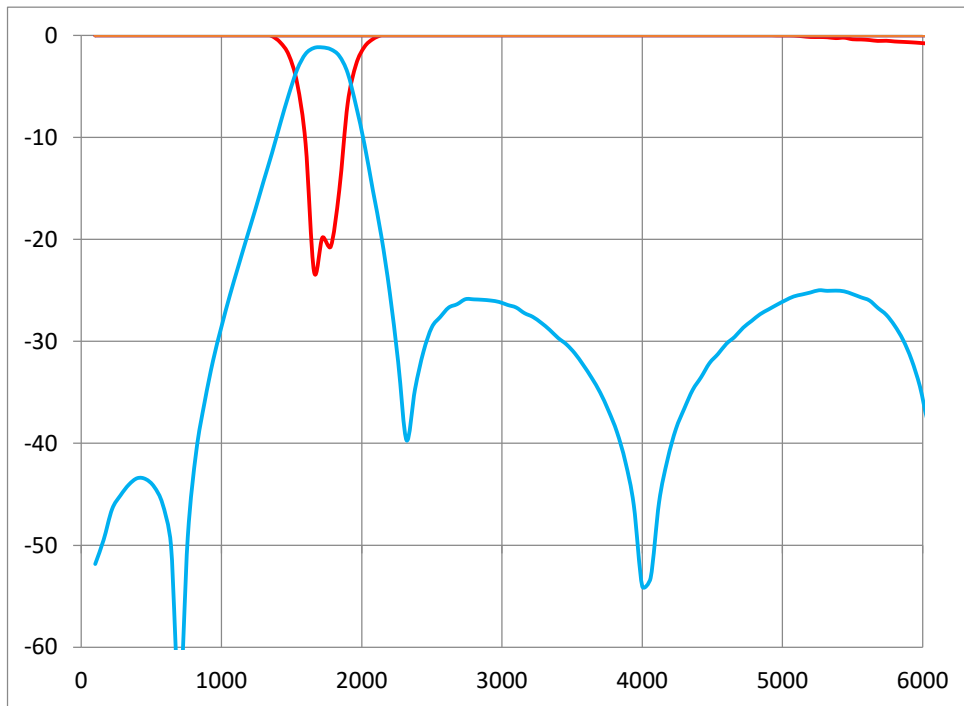

RECOMMENDED PAD LAYOUT: (mm)

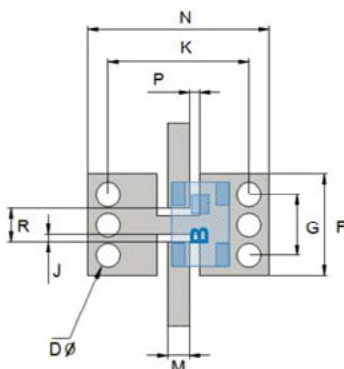

mm

F	2.5±0.05
G	1.5±0.05
J	0.19±0.05
K	3.48±0.05
M	0.54±0.25
N	4.48±0.05
P	0.25±0.05
R	0.85±0.05
D	0.6±0.05

TERMINALS AND LAYOUT: (Top View)

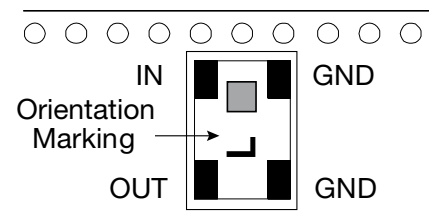

Thin-Film RF/Microwave Filters

BP0805 Band Pass Filter SMD 5W

BP0805A2065ASTR



TYPICAL ELECTRICAL PERFORMANCE

Description	Value
Center frequency	2065 MHz
Impedance	50 Ohm
Band	1930-2200 MHz
I. loss in-band	-1.3dB
Return loss in-band	-12 dB
Attenuation @ DC-1000 MHz	-20 dB
Attenuation @ 4000-5000 MHz	-25 dB
Attenuation @ 5000-6000 MHz	-30 dB
Power handling (CW)	5W

[Click here to return to main table](#)

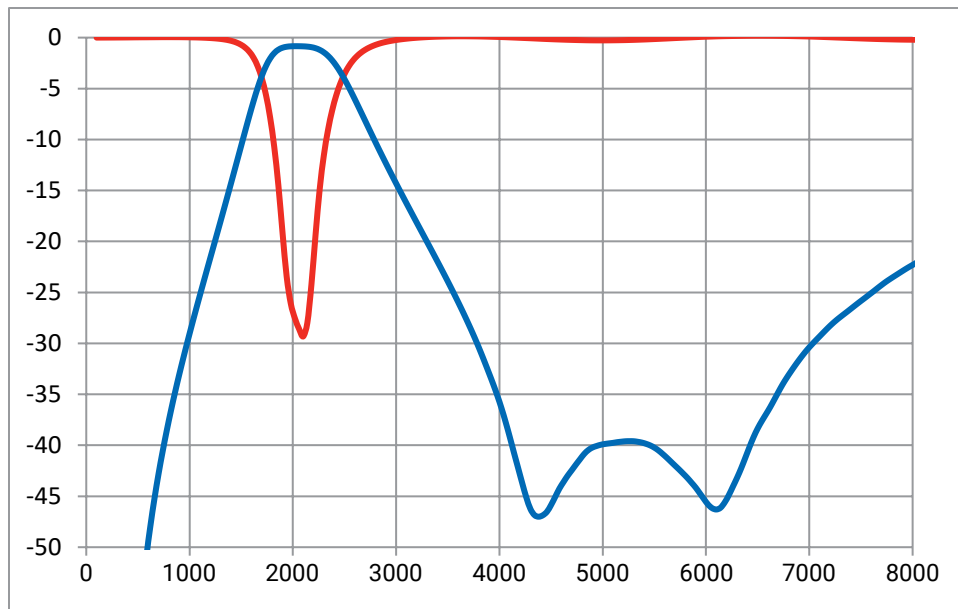

RECOMMENDED PAD LAYOUT: (mm)

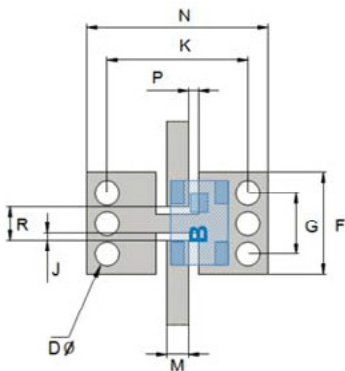

F	2.5±0.05
G	1.5±0.05
J	0.19±0.05
K	3.48±0.05
M	0.54±0.25
N	4.48±0.05
P	0.25±0.05
R	0.85±0.05
D	0.6±0.05

TERMINALS AND LAYOUT: (Top View)

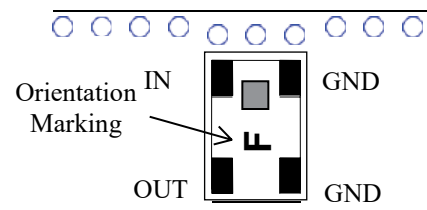

Thin-Film RF/Microwave Filters

BP0805 Band Pass Filter SMD 5W

BP0805A2160ASTR

TYPICAL ELECTRICAL PERFORMANCE

Description	Value
Center frequency	2160 MHz
Impedance	50 Ohm
Band	1960-2360 MHz
I. loss at center frequency	-0.85dB max
In-band return loss	-18dB
Rejection at 440 MHz	-59dB
Rejection at 4320 MHz	-42dB
Rejection at 6480 MHz	-38dB
Power handling (CW)	5W

[Click here to return to main table](#)

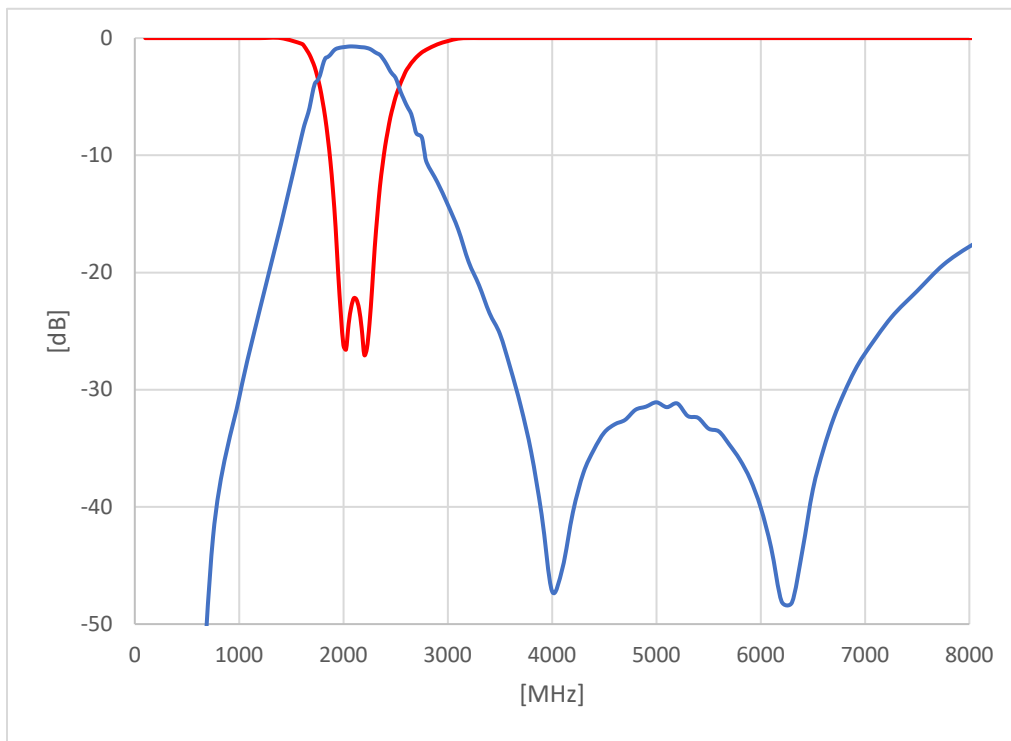

RECOMMENDED PAD LAYOUT: (mm)

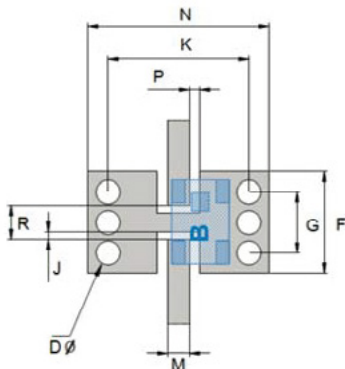

F	2.5±0.05
G	1.5±0.05
J	0.19±0.05
K	3.48±0.05
M	0.54±0.25
N	4.48±0.05
P	0.25±0.05
R	0.85±0.05
D	0.6±0.05

TERMINALS AND LAYOUT: (Top View)

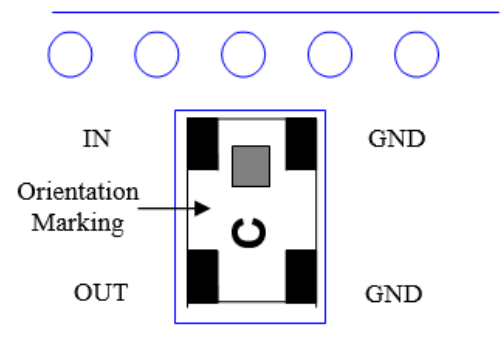

Thin-Film RF/Microwave Filters

BP0805 Band Pass Filter SMD 5W

BP0805A3500ASTR

TYPICAL ELECTRICAL PERFORMANCE

Description	Value
Center frequency	3500 MHz
Impedance	50 Ohm
I. loss 3400-3600 MHz	-1.3dB max.
In-band return loss	-15dB
Rejection in [370 – 2000 MHz]	-20dBc min.
Rejection in [5250-7000 MHz]	-25dBc min
Rejection in [7000-9000 MHz]	-15dBc min
Power Handling (CW)	5 Watt

[Click here to return to main table](#)

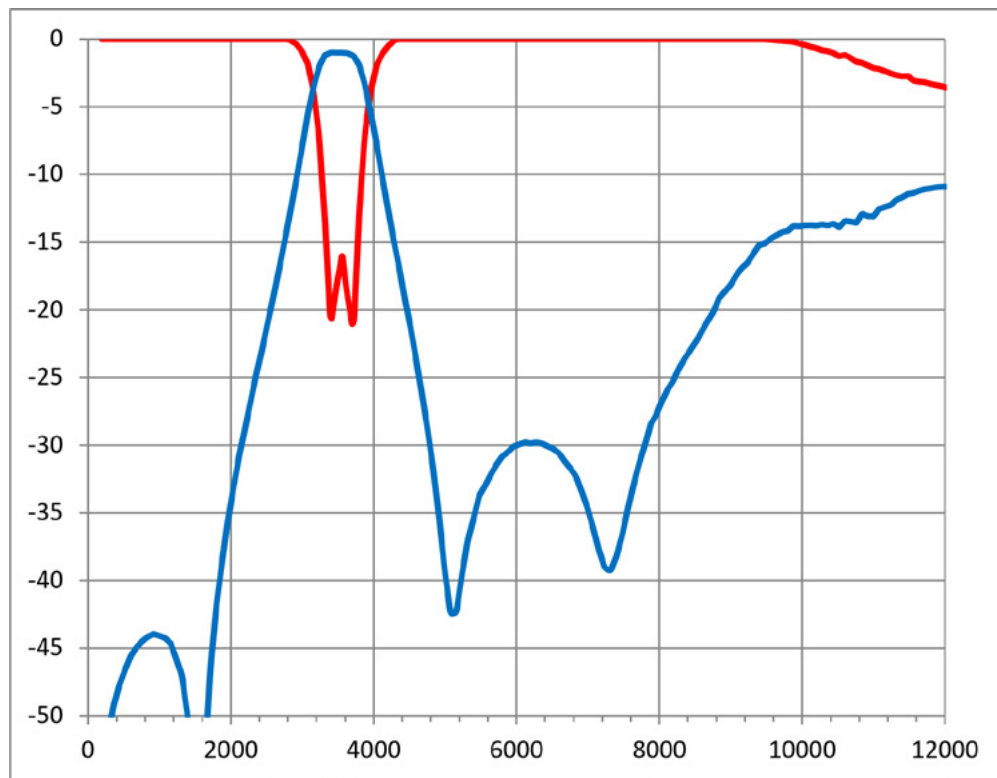

RECOMMENDED PAD LAYOUT: (mm)

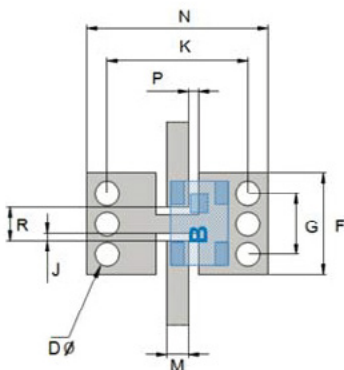

F	2.5±0.05
G	1.5±0.05
J	0.19±0.05
K	3.48±0.05
M	0.54±0.25
N	4.48±0.05
P	0.25±0.05
R	0.85±0.05
D	0.6±0.05

TERMINALS AND LAYOUT: (Top View)

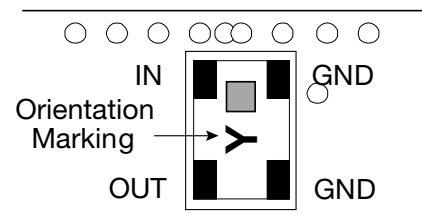

Thin-Film RF/Microwave Filters

BP0805 Band Pass Filter SMD 5W

BP0805A3600ASTR

TYPICAL ELECTRICAL PERFORMANCE

Description	Value
Center frequency	3600 MHz
Impedance	50 ohm
I. loss 3500-3700MHz	-1.3dB max.
In-band return loss	-15dB
rejection in [370 - 2000MHz]	-25dBc min.
rejection in [5300-7200MHz]	-25dBc min
rejection in [7200-11000MHz]	-10dBc min
power handling (CW)	5 Watt

[Click here to return to main table](#)

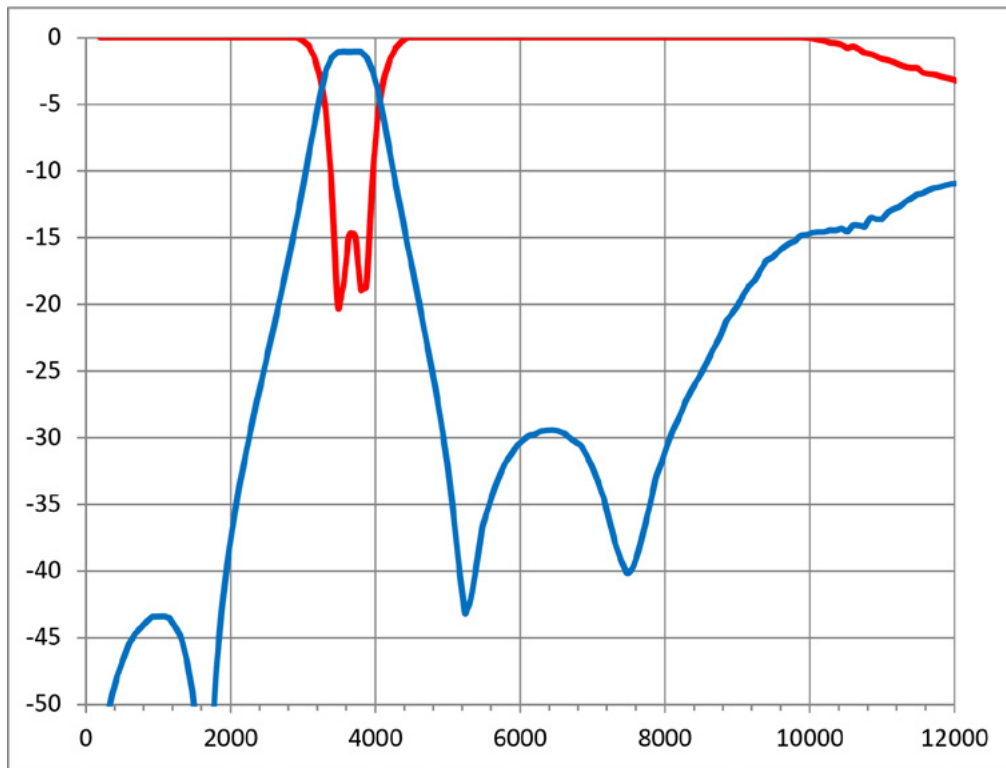

RECOMMENDED PAD LAYOUT: (mm)

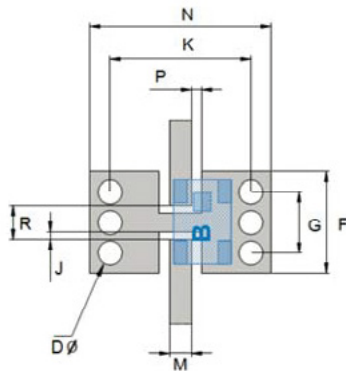

F	2.5±0.05
G	1.5±0.05
J	0.19±0.05
K	3.48±0.05
M	0.54±0.25
N	4.48±0.05
P	0.25±0.05
R	0.85±0.05
D	0.6±0.05

TERMINALS AND LAYOUT: (Top View)

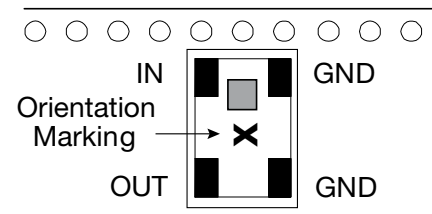

Thin-Film RF/Microwave Filters

BP0805 Band Pass Filter SMD 5W

BP0805A3700ASTR



TYPICAL ELECTRICAL PERFORMANCE

Description	Value
Center frequency	3700 MHz
Impedance	50 Ohm
I. loss 3600-3800 MHz	-1.3dB max.
In-band return loss	-15dB
rejection in [370 – 2000 MHz]	-25dBc min.
rejection in [5300-7400 MHz]	-25dBc min
rejection in [7400-11500 MHz]	-10dBc min
power handling (CW)	5 Watt

[Click here to return to main table](#)

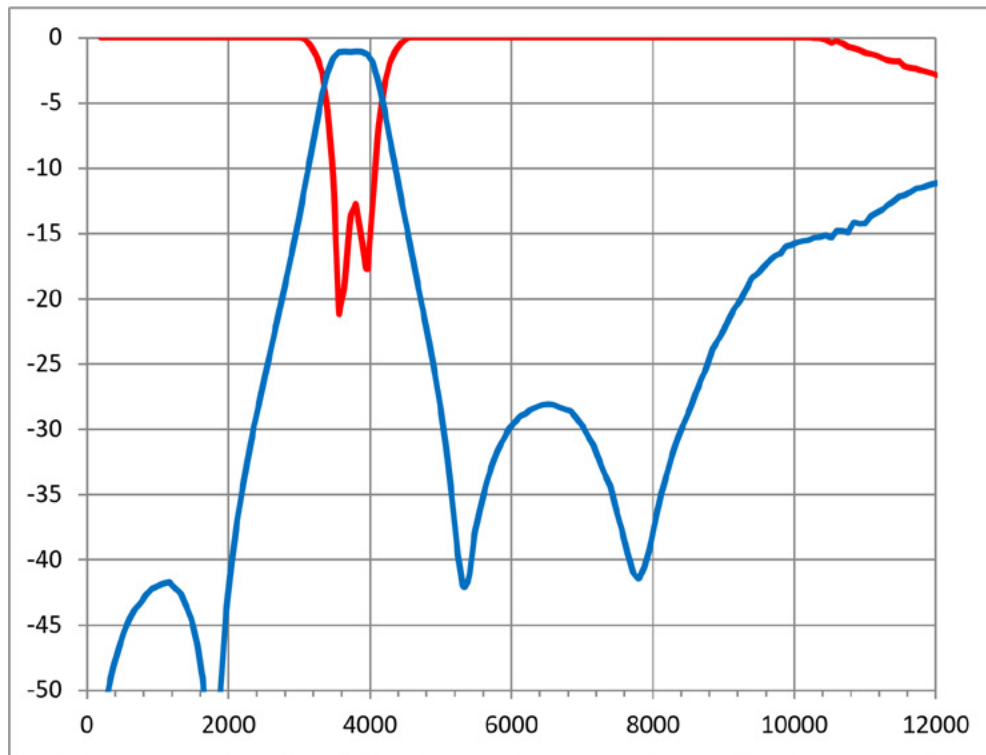

RECOMMENDED PAD LAYOUT: (mm)

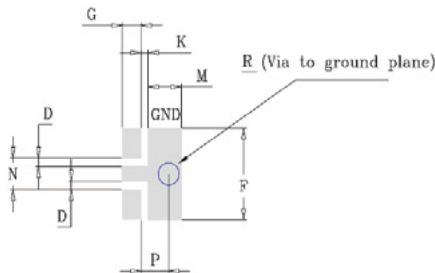

R	∅0.6
G	0.54
K	0.2
N	0.85
M	0.95
F	2.5
P	0.79
D	0.225

TERMINALS AND LAYOUT: (Top View)

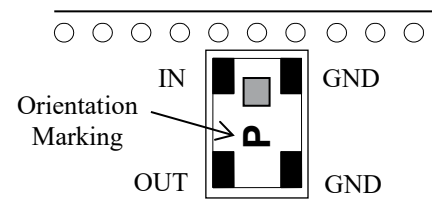

Thin-Film RF/Microwave Filters

BP0805 Band Pass Filter SMD 5W

BP0805A3900ASTR

TYPICAL ELECTRICAL PERFORMANCE

Description	Value
Center frequency	3900 MHz
Impedance	50 Ohm
I. loss 3600-4200 MHz	-2.5 dB
Return loss in-band	-18 dB
Rejection in [DC - 3000 MHz]	-10 dB
Rejection in [5100-6550 MHz]	-22 dB
Rejection in [6550-10000 MHz]	-25 dB
Power handling (CW)	5 Watt

[Click here to return to main table](#)

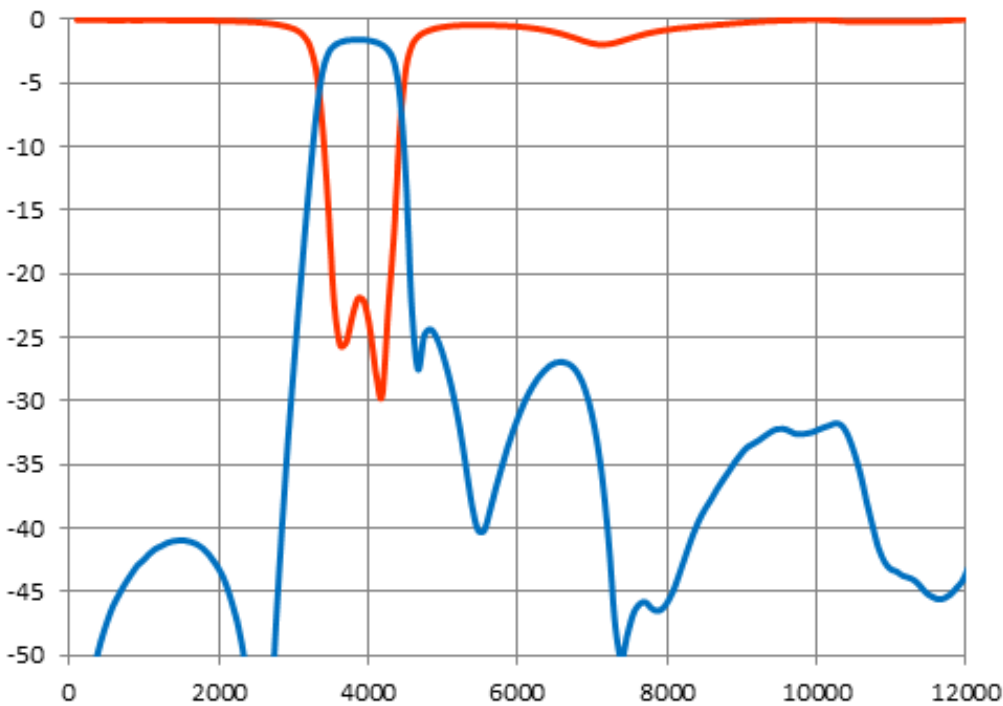

RECOMMENDED PAD LAYOUT: (mm)

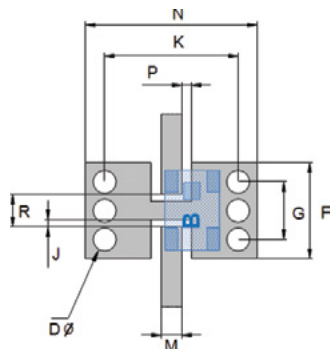

F	2.5±0.05
G	1.5±0.05
J	0.19±0.05
K	3.48±0.05
M	0.54±0.25
N	4.48±0.05
P	0.25±0.05
R	0.85±0.05
D	0.6±0.05

TERMINALS AND LAYOUT: (Top View)

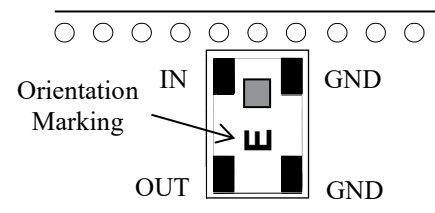

Thin-Film RF/Microwave Filters

BP0805 Band Pass Filter SMD 5W

BP0805B4050ASTR



TYPICAL ELECTRICAL PERFORMANCE

Description	Value
Center frequency	4050 MHz
Impedance	50 ohm
I. loss 4000-4100MHz	-1.3dB max.
In-band return loss	-18dB
Rejection in DC-2000MHz	-25dBc min.
Rejection in 6000-8000MHz	-25dBc min
Rejection in 10000-12000MHz	-15dBc min
Power handling (CW)	5 Watt

[Click here to return to main table](#)

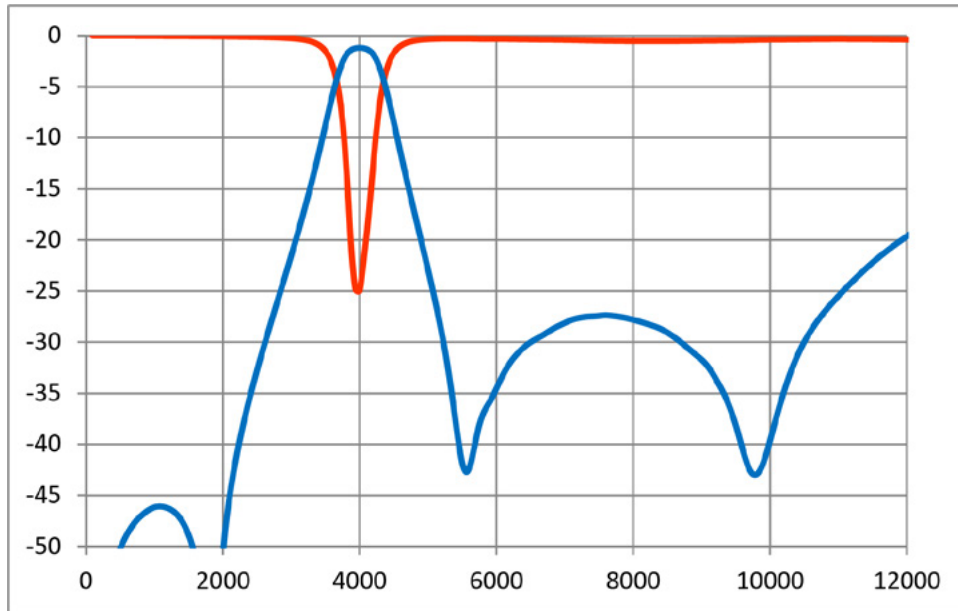

RECOMMENDED PAD LAYOUT: (mm)

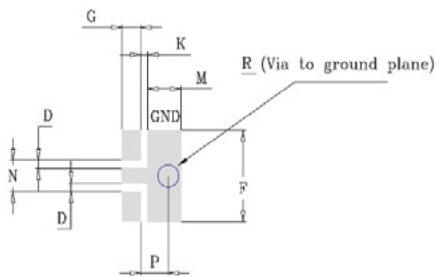

mm

R	∅0.6
G	0.54
K	0.2
N	0.85
M	0.95
F	2.5
P	0.79
D	0.225

TERMINALS AND LAYOUT: (Top View)

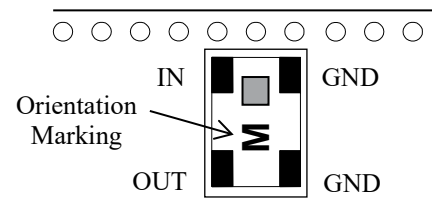

Thin-Film RF/Microwave Filters

BP0805 Band Pass Filter SMD 5W

BP0805A4320ASTR

TYPICAL ELECTRICAL PERFORMANCE

Description	Value
Center frequency	4320 MHz
Impedance	50 Ohm
Band	4120-4520 MHz
I. loss at center frequency	1.2dB max
In-band return loss	15dB
Rejection at 2160 MHz	45dBc min
Rejection at 6480 MHz	39dBc min
Rejection at 8640 MHz	44dBc min
Power handling (CW)	5W

[Click here to return to main table](#)

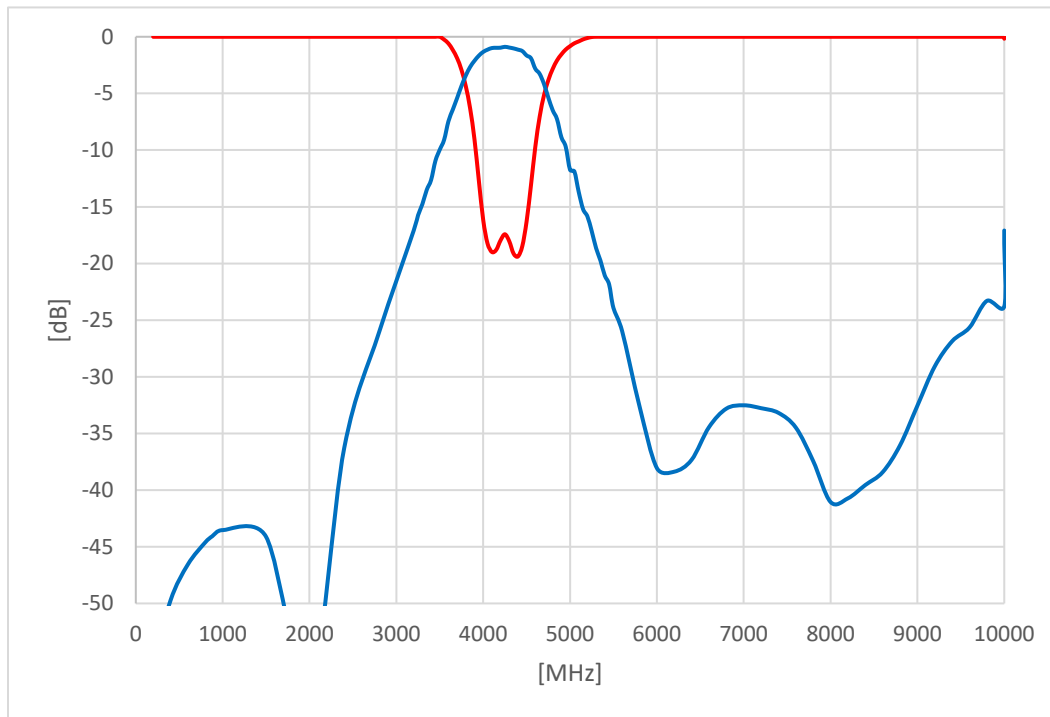

RECOMMENDED PAD LAYOUT: (mm)

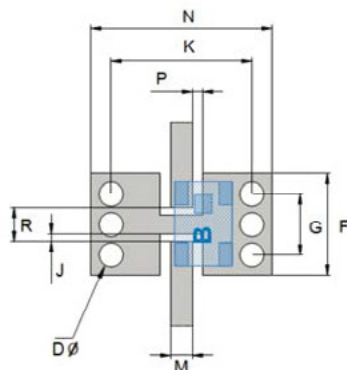

mm	
F	2.5±0.05
G	1.5±0.05
J	0.19±0.05
K	3.48±0.05
M	0.54±0.25
N	4.48±0.05
P	0.25±0.05
R	0.85±0.05
D	0.6±0.05

TERMINALS AND LAYOUT: (Top View)

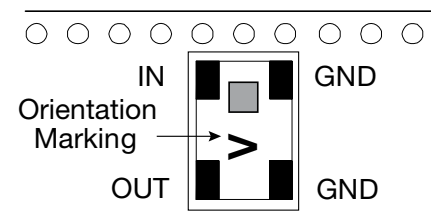

Thin-Film RF/Microwave Filters

BP0805 Band Pass Filter SMD 5W

BP0805A7250ASTR



TYPICAL ELECTRICAL PERFORMANCE

Description	Value
Center frequency	7250 MHz
Impedance	50 Ohm
I. loss 6625-7875 MHz	-1.5 dB
Return loss in-band	-12 dB
Rejection in [DC - 5400 MHz]	-25 dB
Rejection in [10000 - 15000 MHz]	-25 dB
Power handling (CW)	5 Watt

[Click here to return to main table](#)

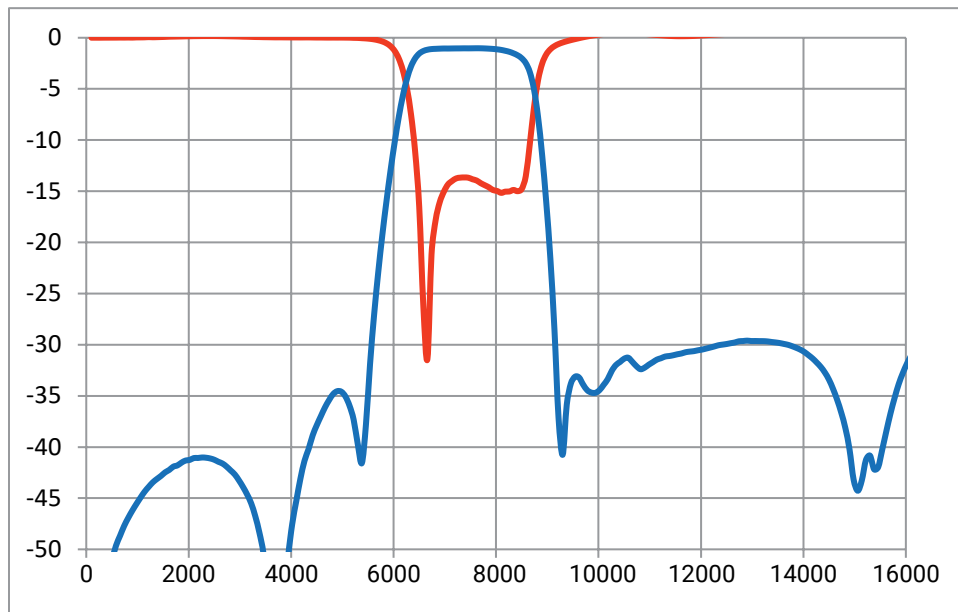

RECOMMENDED PAD LAYOUT: (mm)

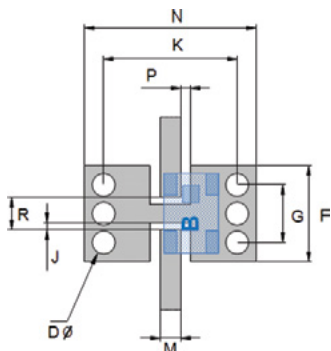

F	2.5±0.05
G	1.5±0.05
J	0.19±0.05
K	3.48±0.05
M	0.54±0.25
N	4.48±0.05
P	0.25±0.05
R	0.85±0.05
D	0.6±0.05

TERMINALS AND LAYOUT: (Top View)

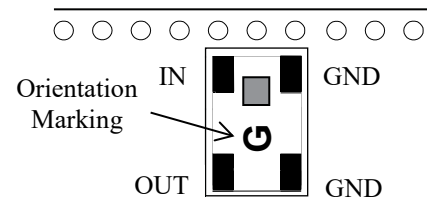



High Performance Band Pass Filters

BP1206 Band Pass Filter SMD 8W

Thin-Film RF/Microwave Filters

BP1206 Band Pass Filter SMD 8W

General Information

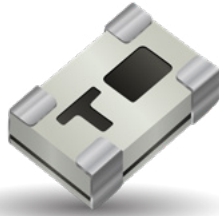

ITF TECHNOLOGY

The BP1206 Band Pass Filter is based on thin-film multilayer technology. The technology provides a miniature part with excellent high frequency performance and rugged construction for reliable automatic assembly.

The ITF Filter is offered in a variety of frequency bands compatible with various types of high frequency wireless systems.

FEATURES

- Small size: 1206
- Characteristic impedance: 50Ω
- Operating / Storage temp: -40°C – +105°C
- Low profile
- Rugged construction
- Taped and reeled
- RoHS compliant

APPLICATIONS

- 5G / 6G / UWB Applications
- Base Stations
- Mobile communications
- Satellite TV receivers
- GPS
- Vehicle location systems
- Wireless LAN's

HOW TO ORDER

BP	1206	A	XXXX	A	S	TR
Series	Case Size	Type	Frequency (MHz)	Sub-Type	Termination	Taped & Reeled

FINAL QUALITY INSPECTION

Finished parts are 100% tested for electrical parameters and visual/ mechanical characteristics. Each production lot is evaluated on a sample basis for:

- Static Humidity: 85°C, 85% RH, 160 hours
- Endurance : 125°C, IR, 4 hours

TERMINATION

Nickel/ Lead free Solder coating (Sn100) compatible with automatic soldering technologies: reflow, wave soldering, vapor phase and manual.

DIMENSIONS (TOP VIEW)

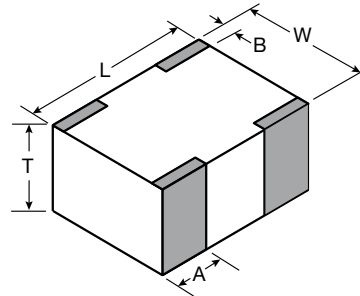

mm (inches)

L	3.08±0.1 (0.121±0.004)
W	1.60±0.1 (0.063±0.004)
T	0.87±0.1 (0.034±0.004)
A	0.61±0.25 (0.028±0.010)
B	0.35±0.15 (0.014±0.006)

ELECTRICAL SPECIFICATIONS TABLE

Part Number	Band [MHz]	Insertion Loss [dB]	Low Band Rejection [dB]	High Band Rejection [dB]	
BP1206A0802ASTR	680 – 925	-1.1	-15 @ DC - 400 MHz	-30 @ 2000 – 3000 MHz	-18 @ 3000 - 4000
BP1206A0879ASTR	800 - 960	-1.2	-22 @ DC - 400 MHz	-28 @ 1600 – 3000 MHz	-18 @ 3000 - 4000
BP1206A2700ASTR	2600 - 2800	-1.9	- 27 @ DC-2000	-40 @ 4000 - 6000 MHz	-27 @ 6001 -8100
BP1206A2800ASTR	2700 - 2900	-1.9	- 27 @ DC-2000	-40 @ 4000 - 6000 MHz	-27 @ 6001 -8400
BP1206A2880ASTR	2380 - 3380	-1.5	-30 @ 460 - 1460	-30 @ 4300 - 5300 MHz	-
BP1206A2900ASTR	2800 - 3000	-1.8	- 27 @ DC - 2000	-38 @ 4000 - 6000 MHz	-25 @ 6001 -8700
BP1206A6670ASTR	5905 - 7450	-1.5	-30 @ 1000 - 3000	-20 @ 4900 - 5120 MHz	-35 @ 10800 - 13000

Click on part number to see full specifications

Custom Band Pass Filters are Available Per Request

Thin-Film RF/Microwave Filters

BP1206 Band Pass Filter SMD 8W

BP1206A0802ASTR

TYPICAL ELECTRICAL PERFORMANCE

Description	Value
Center frequency	802 MHz
Impedance	50 ohm
I.loss 680-925MHz	-1.1dB max.
In-band return loss	-18dB
Rejection in [DC~400MHz]	-15dBc min.
Rejection in [2000~3000MHz]	-30dBc min
Rejection in [3000~4000MHz]	-18dBc min
Power handling (CW)	8 Watt
Operating temperature range	-40/+105 °C
Package	SMD, standard 1206 size

[Click here to return to main table](#)

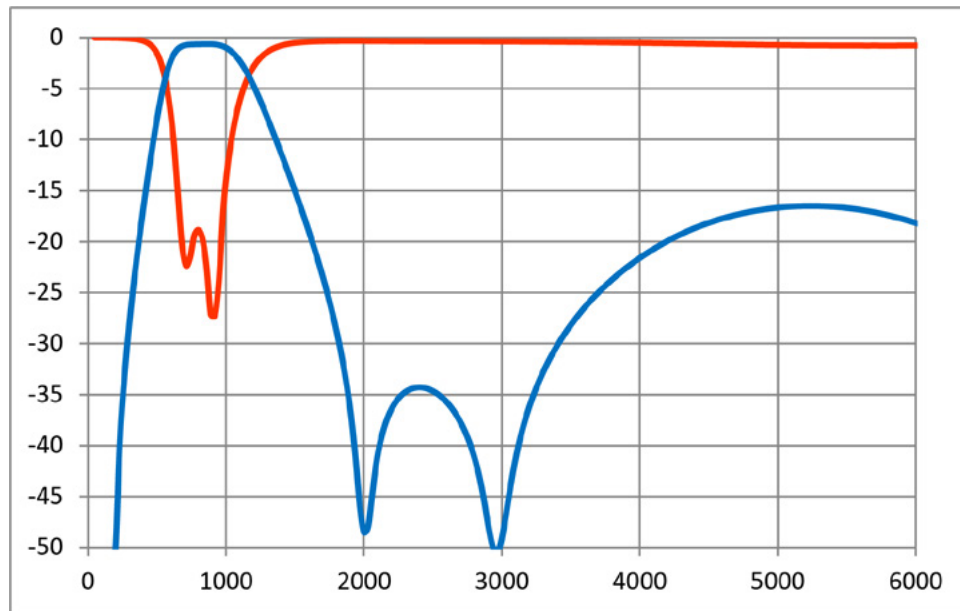

TERMINAL AND LAYOUT (TOP VIEW)

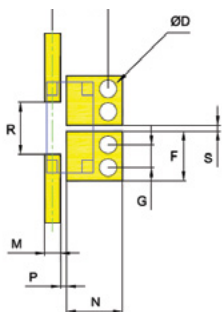

mm	
F	1.70±0.05
G	0.75±0.05
K	1.91±0.10
M	0.54±0.025
N	1.93±0.05
P	0.21±0.04
R	1.80±0.04
S	0.20±0.04
D	0.6±0.1

TERMINAL AND LAYOUT (TOP VIEW)

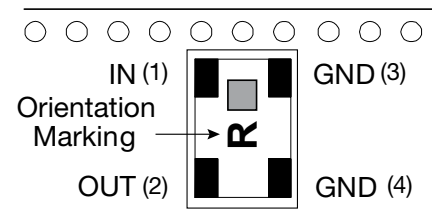

Thin-Film RF/Microwave Filters

BP1206 Band Pass Filter SMD 8W

BP1206A0879ASTR



TYPICAL ELECTRICAL PERFORMANCE

Description	Value
Center frequency	879 MHz
Impedance	50 ohm
I. loss 800-960MHz	-1.2dB max.
In-band return loss	-18dB
Rejection in [DC~400MHz]	-22dBc min.
Rejection in [1600~3000MHz]	-28dBc min
Rejection in [3000~4000MHz]	-18dBc min
Power handling (CW)	8 Watt
Operating temperature range	-40/+105 degC
Package	SMD, standard 1206 size

[Click here to return to main table](#)

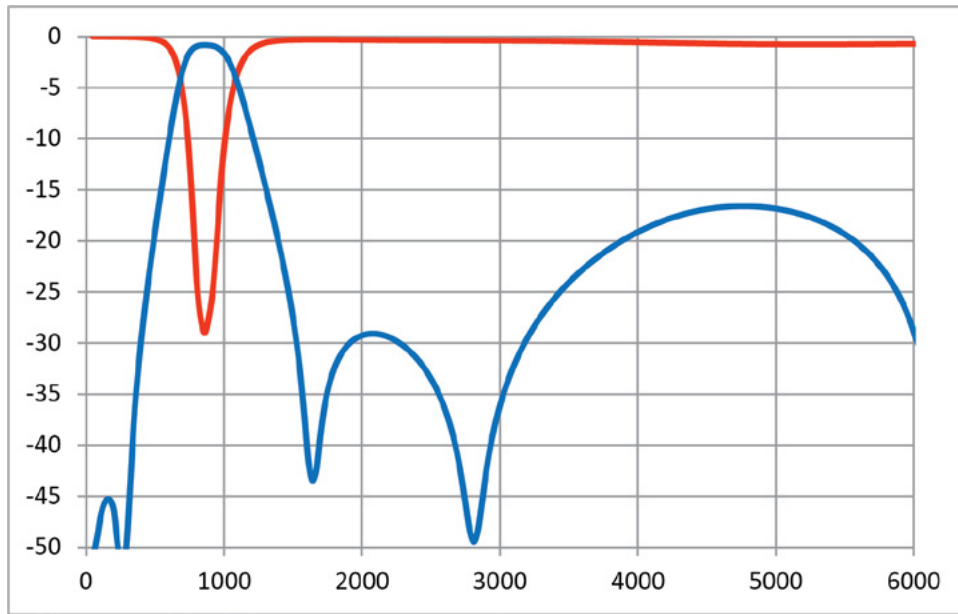

TERMINAL AND LAYOUT (TOP VIEW)

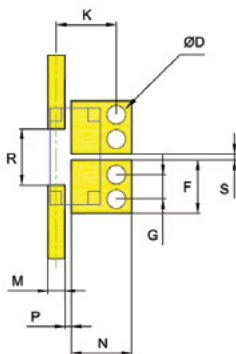

mm

F	1.70±0.05
G	0.75±0.05
K	1.91±0.10
M	0.54±0.025
N	1.93±0.05
P	0.21±0.04
R	1.80±0.04
S	0.20±0.04
D	0.6±0.1

TERMINAL AND LAYOUT (TOP VIEW)

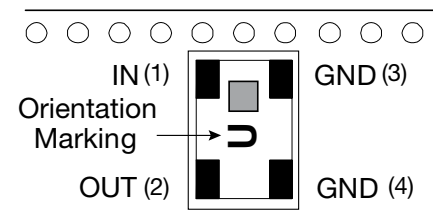

Thin-Film RF/Microwave Filters

BP1206 Band Pass Filter SMD 8W

BP1206A2700ASTR



TYPICAL ELECTRICAL PERFORMANCE

Description	Value
Center frequency	2700 MHz
Impedance	50 ohm
I. loss 2600-2800MHz	-1.9 dB
In-band Return Loss	-12 dB
Rejection @ 2000 MHz	-27 dB
Rejection @ 4000-6000 MHz	-40dB
Rejection @ 6001-8100 MHz	-27dB
Power Handling (CW)	8 Watt
Operating Temperature Range	-40/+85°C
Package	SMD, standard 1206 size

[Click here to return to main table](#)

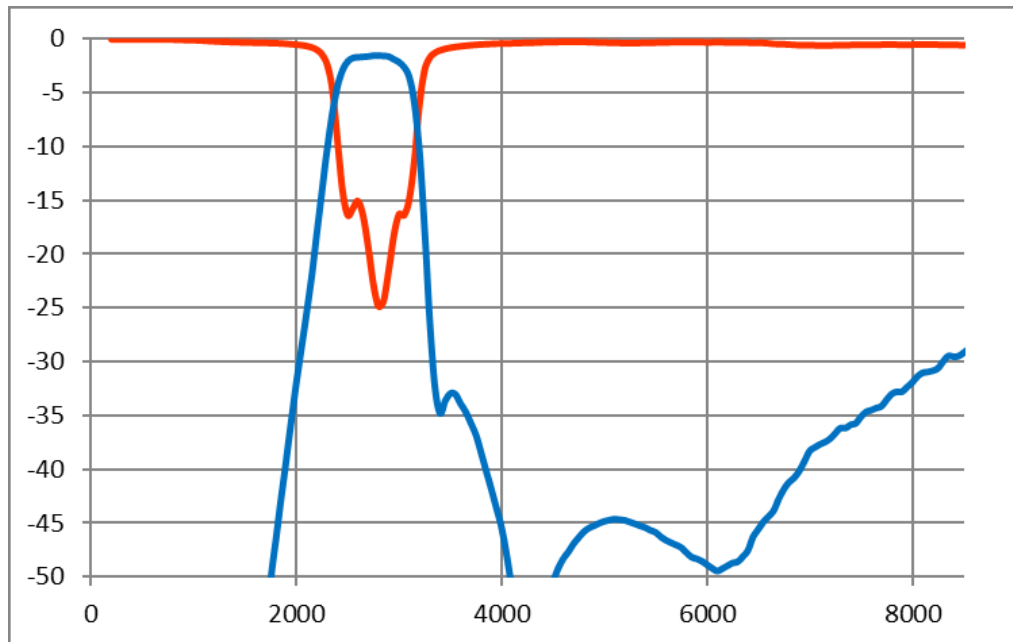

TERMINAL AND LAYOUT (TOP VIEW)

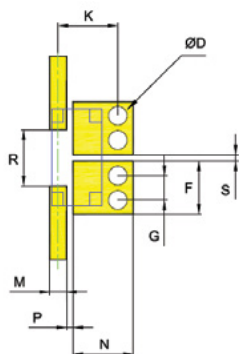

mm

F	1.70±0.05
G	0.75±0.05
K	1.91±0.10
M	0.54±0.025
N	1.93±0.05
P	0.21±0.04
R	1.80±0.04
S	0.20±0.04
D	0.6±0.1

TERMINAL AND LAYOUT (TOP VIEW)

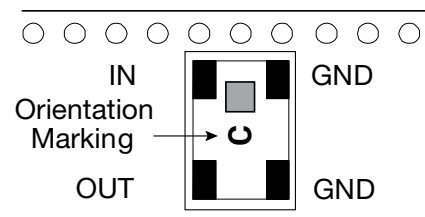

Thin-Film RF/Microwave Filters

BP1206 Band Pass Filter SMD 8W

BP1206A2800ASTR

TYPICAL ELECTRICAL PERFORMANCE

Description	Value
Center frequency	2800 MHz
Impedance	50 ohm
I. loss 2700 - 2900 MHz	-1.9 dB
In band Return Loss	-12 dB
Rejection @ 2000 MHz	-27 dB
Rejection @ 4000 - 6000 MHz	-40 dB
Rejection @ 6001 - 8400 MHz	-27 dB
Power handling (CW)	8 Watt
Operating temperature range	-40/+85°C
Package	SMD, standard 1206 size

[Click here to return to main table](#)

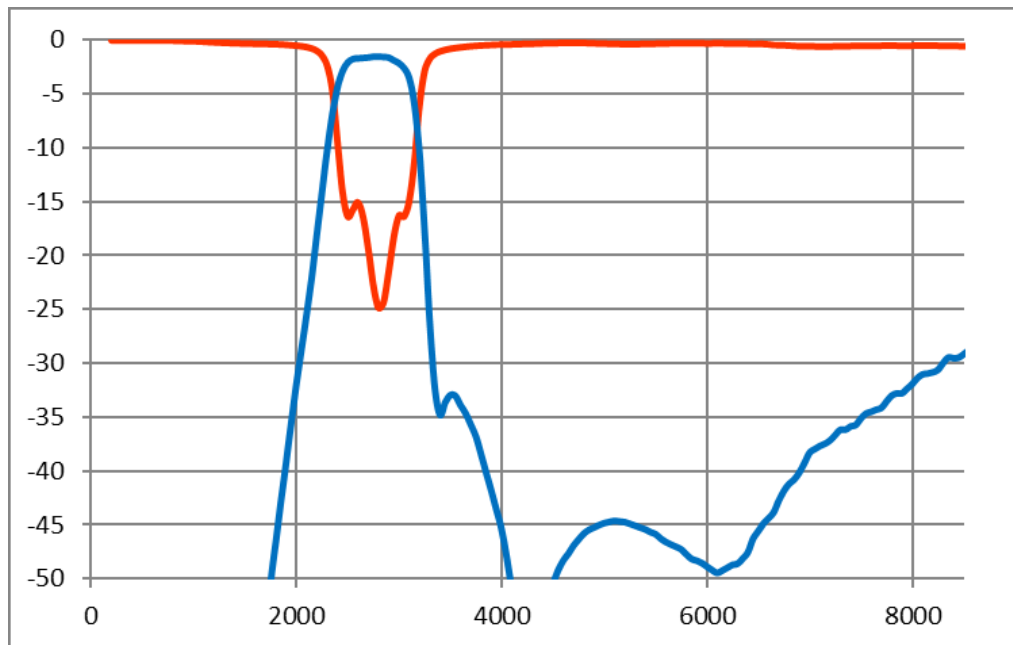

TERMINAL AND LAYOUT (TOP VIEW)

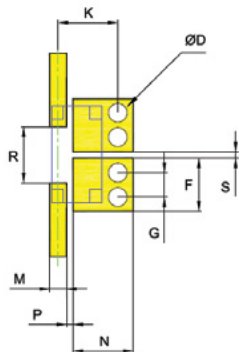

mm

F	1.70±0.05
G	0.75±0.05
K	1.91±0.10
M	0.54±0.025
N	1.93±0.05
P	0.21±0.04
R	1.80±0.04
S	0.20±0.04
D	0.6±0.1

TERMINAL AND LAYOUT (TOP VIEW)

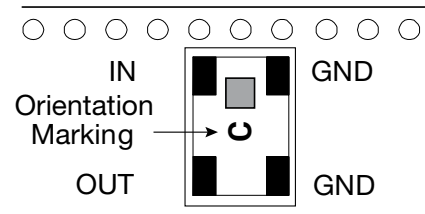

Thin-Film RF/Microwave Filters

BP1206 Band Pass Filter SMD 8W

BP1206A2880ASTR



TYPICAL ELECTRICAL PERFORMANCE

Description	Value
Center frequency	2880 MHz
Impedance	50 ohm
I. loss 2380-3380MHz	-1.5dB max.
In-band return loss	-15dB
Rejection in [460-1460] MHz	-30dBc min.
Rejection in [4300-5300] MHz	-30dBc min.
Power handling (CW)	8 Watt
Operating temperature range	-40/+105 degC
Package	SMD, standard 1206 size

[Click here to return to main table](#)

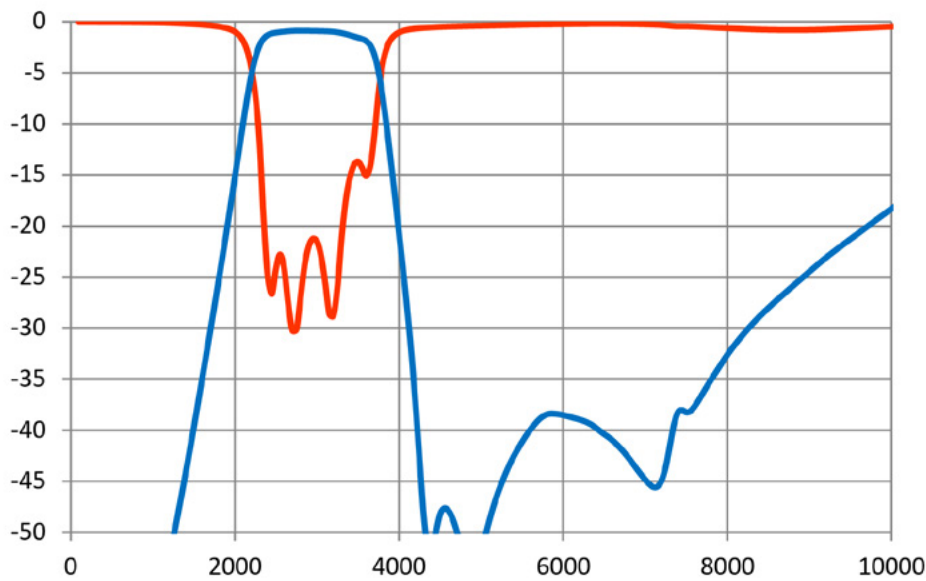

TERMINAL AND LAYOUT (TOP VIEW)

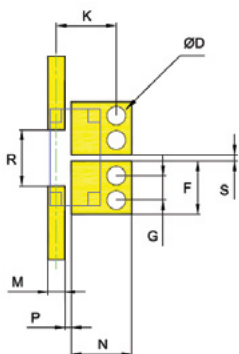

mm

F	1.70±0.05
G	0.75±0.05
K	1.91±0.10
M	0.54±0.025
N	1.93±0.05
P	0.21±0.04
R	1.80±0.04
S	0.20±0.04
D	0.6±0.1

TERMINAL AND LAYOUT (TOP VIEW)

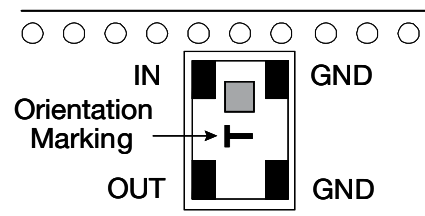

Thin-Film RF/Microwave Filters

BP1206 Band Pass Filter SMD 8W

BP1206A2900ASTR



TYPICAL ELECTRICAL PERFORMANCE

Description	Value
Center frequency	2900 MHz
Impedance	50 ohm
I. loss 2800 - 3000 MHz	-1.8 dB
In Band Return Loss	-12 dB
Rejection @ 2000 MHz	-27 dB
Rejection @ 4000 - 6000 MHz	-38 dB
Rejection @ 6001 - 8700 MHz	-25 dB
Power Handling (CW)	8 Watt
Operating Temperature Range	-40/+85°C
Package	SMD, standard 1206 size

[Click here to return to main table](#)

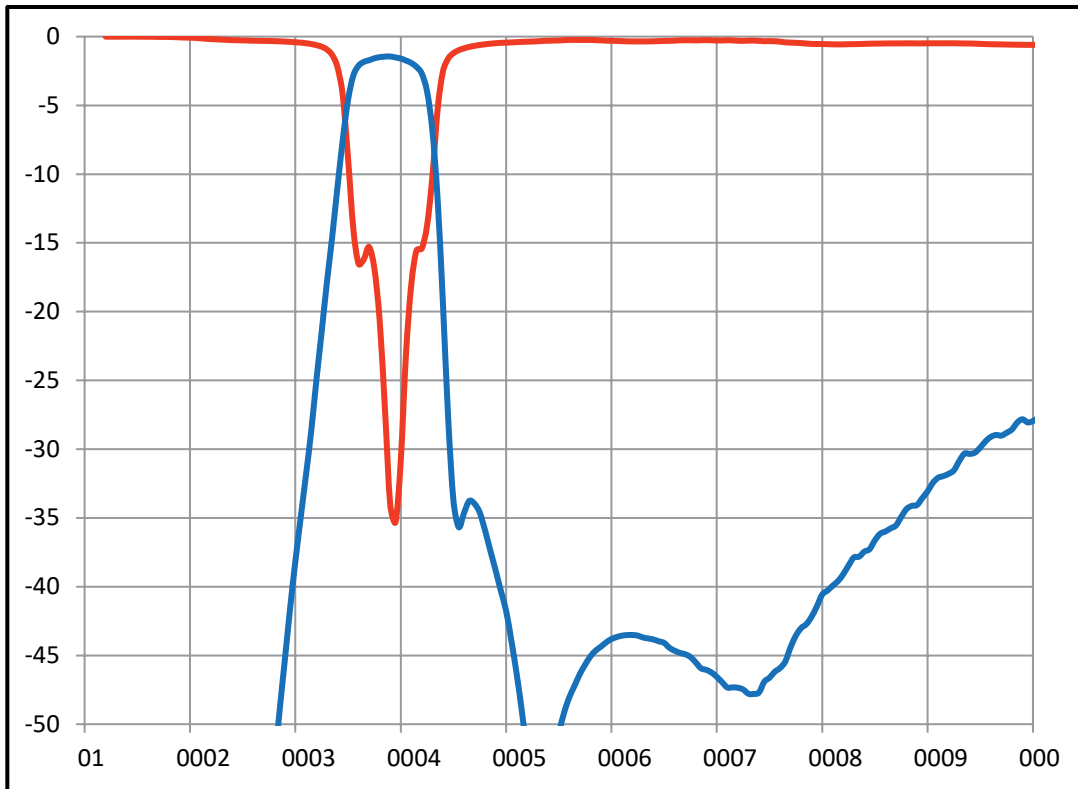

TERMINAL AND LAYOUT (TOP VIEW)

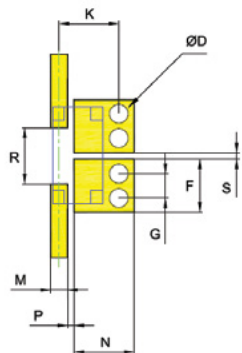

mm

F	1.70±0.05
G	0.75±0.05
K	1.91±0.10
M	0.54±0.025
N	1.93±0.05
P	0.21±0.04
R	1.80±0.04
S	0.20±0.04
D	0.6±0.1

TERMINAL AND LAYOUT (TOP VIEW)

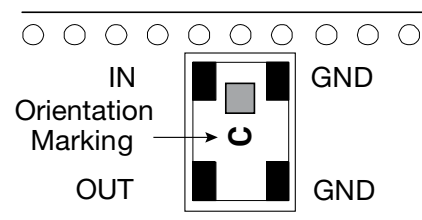

Thin-Film RF/Microwave Filters

BP1206 Band Pass Filter SMD 8W

BP1206A6670ASTR

TYPICAL ELECTRICAL PERFORMANCE

Description	Value
Center frequency	6670 MHz
Impedance	50 ohm
I. loss 5905-7450MHz	-1.5dB max.
In-band return loss	-18dB
Rejection in [1000~3000MHz]	-30dBc min.
Rejection in [4900~5120MHz]	-20dBc min
Rejection in [10800~13000MHz]	-35dBc min
Power handling (CW)	8 Watt
Operating temperature range	-40/+105 degC
Package	SMD, standard 1206 size

[Click here to return to main table](#)

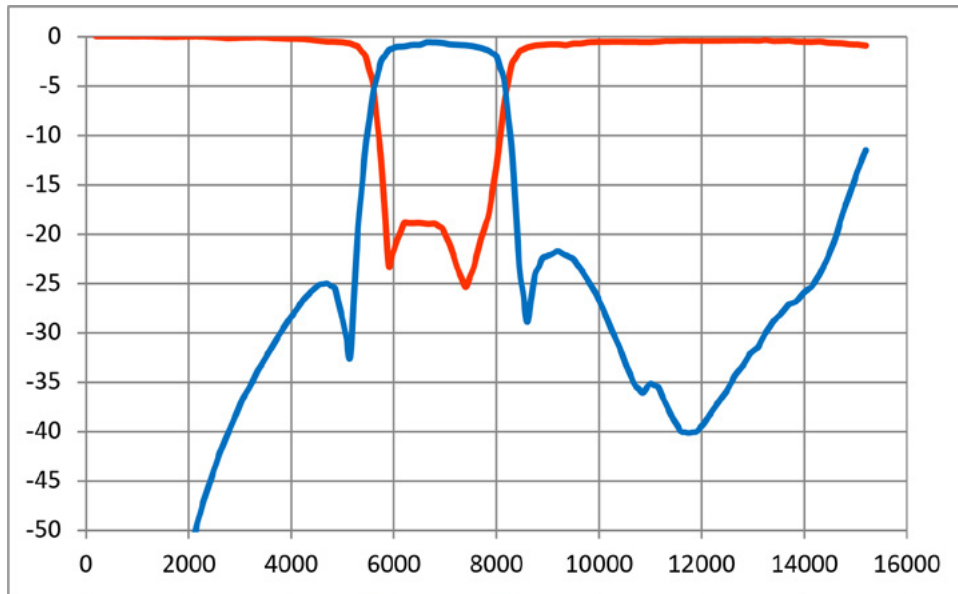

TERMINAL AND LAYOUT (TOP VIEW)

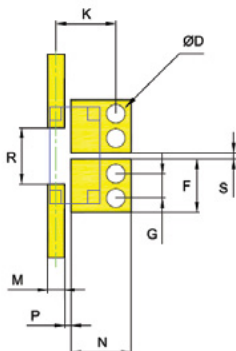

mm

F	1.70±0.05
G	0.75±0.05
K	1.91±0.10
M	0.54±0.025
N	1.93±0.05
P	0.21±0.04
R	1.80±0.04
S	0.20±0.04
D	0.6±0.1

TERMINAL AND LAYOUT (TOP VIEW)

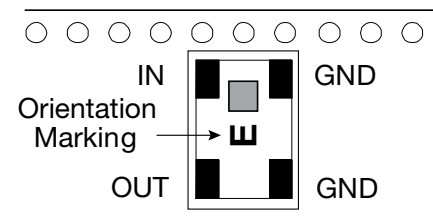



Multilayer Organic (MLO®) Technology

MLO® Filters

MLO® Capacitors

MLO® Diplexers

MLO® Inductors

MLO® SMT Crossovers

Multilayer Organic (MLO®) Filters

MLO® High Pass Filters

General Information

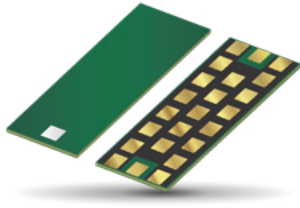

GENERAL DESCRIPTION

The MLO® High Pass Filters are low profile passive devices with best in class performance based on KYOCERA AVX patented multilayer organic high density interconnect technology. The MLO® High pass filters utilize high dielectric constant and low loss materials to realize high Q passive printed elements, such as inductors and capacitors, in a multilayer stack. This results in a high performance High Pass Filter design. MLO® High Pass Filters can support both a variety of frequency bands and multiple wireless standards, and are less than 1.0mm in thickness. All filters are expansion matched to most organic PCB materials, thereby resulting in improved reliability over standard silicon and ceramic devices.

FEATURES

- Wide Frequency Range
- Excellent Isolation
- Low Loss
- Expansion matched to PCB
- 50Ω Impedance
- Surface Mountable
- RoHS Compliant
- High Q

APPLICATIONS

- Mobile Communication
- GPS
- Vehicle location systems
- Wireless LANs
- Satellite Receivers
- Instrumentation

LAND GRID ARRAY ADVANTAGES

- Inherent Low Profile
- Excellent Solderability
- Better Heat Dissipation

HOW TO ORDER

HF ┆ Series	0A ┆ Case Size	A ┆ Type	2470 ┆ Frequency In MHz	A ┆ Standard Testing	7 ┆ Termination	00 ┆ Package Code
High Pass Filters	0A = 2616 0B = 3116 0C = 3416 0D = 4016 1E = 4617	2E = 4614 0E = 4617 0F = 5021			7 – Gold	00 – Waffle Pack TR – 1000 pcs Tape & Reel TR\250 – 250 pcs Tape & Reel



For RoHS compliant products, please select correct termination style.

QUALITY INSPECTION

Finish Parts are 100% electrically tested.

TERMINATION

All finishes are compatible with automatic soldering technologies: Pb free reflow, wave soldering, vapor phase, and manual soldering.

OPERATING TEMPERATURE

-55°C to +85°C

MECHANICAL DIMENSIONS:

inches (mm)

Case Size	Length	Width	Height
A 2616	0.259±0.010 (6.579±0.254)	0.157±0.010 (3.975±0.254)	Varies - see part specification
B 3116	0.306±0.010 (7.785±0.254)	0.156±0.010 (3.975±0.254)	Varies - see part specification
C 3416	0.342±0.010 (8.674±0.254)	0.157±0.010 (3.975±0.254)	Varies - see part specification
D 4016	0.401±0.010 (10.198±0.254)	0.156±0.010 (3.975±0.254)	Varies - see part specification
E 4617	0.460±0.010 (11.684±0.254)	0.170±0.010 (4.318±0.254)	Varies - see part specification
1E 4617	0.460±0.010 (11.684±0.254)	0.174±0.004 (4.41±0.10)	Varies - see part specification
2E 4614	0.460±0.010 (11.684±0.254)	0.144±0.004 (3.64±0.10)	Varies - see part specification
F 5021	0.512±0.010 (12.992±0.254)	0.207±0.010 (5.245±0.254)	Varies - see part specification



S2P FILES, DRAWING AND OTHER INFORMATION AVAILABLE IN LINK ON INDIVIDUAL DATASHEETS



The Important Information/Disclaimer is incorporated in the catalog where these specifications came from or available online at www.kyocera-avx.com/disclaimer/ by reference and should be reviewed in full before placing any order.

Multilayer Organic (MLO®) Filters

MLO® High Pass Filters

ELECTRICAL SPECIFICATIONS

Part Number	Passband (GHz)		Insertion Loss (dB)		Typical -3dB Cutoff Frequency (GHz)	Stopband Rejection Frequency (GHz)		Rated RF Power (W)
	Min	Max	Typ.	Max		-30dB	-40dB	
HF0DA0740A7**	0.74	1.47	0.84	1.20	0.65	0.54	0.52	2
HF0BA0850A7**	0.85	1.94	0.75	1.20	0.77	0.64	0.63	2
HF0BA0930A7**	0.93	1.62	0.87	1.20	0.82	0.69	0.68	2
HF0BA0950A7**	0.95	2.00	0.90	1.20	0.85	0.71	0.65	2
HF0AA1300A7**	1.30	7.00	0.53	1.20	1.10	0.58	0.50	2
HF0AA1330A7**	1.33	6.59	0.55	1.20	1.12	0.59	0.51	2
HF0BA1340A7**	1.34	2.39	0.74	1.20	1.17	1.00	0.97	2
HF0BA1390A7**	1.39	2.52	0.75	1.20	1.21	1.02	1.00	2
HF0BA1420A7**	1.42	2.57	0.70	1.20	1.22	1.03	1.00	2
HF0BA1440A7**	1.44	2.70	0.63	1.20	1.30	1.09	1.06	2
HF0BA1500A7**	1.50	2.83	0.75	1.20	1.38	1.17	1.15	2
HF0BA1540A7**	1.54	2.68	0.82	1.20	1.39	1.18	1.10	2
HF0BA1550A7**	1.55	2.93	0.82	1.20	1.41	1.19	-	2
HF0AA1760A7**	1.76	3.50	0.64	1.20	1.49	1.29	1.26	2
HF0AA1800A7**	1.80	4.21	0.76	1.20	1.59	1.31	1.20	2
HF0BA1840A7**	1.84	2.83	0.85	1.20	1.66	1.43	1.40	2
HF0AA2180A7**	2.18	6.50	0.73	1.20	1.90	1.63	1.60	2
HF0AA2230A7**	2.23	6.50	0.71	1.20	1.93	1.69	1.66	2
HF0AA2290A7**	2.29	7.00	0.73	1.20	1.99	1.74	1.71	2
HF0AA2370A7**	2.37	7.00	0.76	1.20	2.06	1.80	1.77	2
HF0AA2400A7**	2.40	7.00	0.61	1.20	2.01	1.75	1.71	2
HF0AA2410A7**	2.41	7.00	0.75	1.20	2.08	1.81	1.78	2
HF0AA2420A7**	2.42	7.00	0.73	1.20	2.04	1.78	1.75	2
HF0AA2470A7**	2.47	6.50	0.76	1.20	2.13	1.86	1.82	2
HF0AA2480A7**	2.48	6.00	0.71	1.20	2.11	1.84	1.81	2
HF0AA3280A7**	3.28	8.50	0.91	1.20	3.02	2.53	2.43	2
HF0AA3460A7**	3.46	8.50	0.75	1.20	3.14	2.61	2.52	2
HF0AA3540A7**	3.54	8.50	0.85	1.20	2.92	2.42	2.27	2
HF0AA4140A7**	4.14	8.50	0.66	1.20	3.59	2.83	2.71	2
HF0AA4270A7**	4.27	8.00	0.77	1.20	3.76	3.17	-	2
HF0AA4430A7**	4.43	7.00	0.61	1.20	3.88	2.98	2.86	2
HF0AA4500A7**	4.50	7.50	0.65	1.20	3.93	3.08	2.96	2
HF0AA4680A7**	4.68	7.50	0.62	1.20	4.09	3.21	3.08	2
HF0AA6240A7**	6.24	8.00	0.80	1.20	5.37	4.76	4.68	2
HF0AA6380A7**	6.38	8.00	0.74	1.20	5.28	4.61	4.54	2
HF0AA6510A7**	6.51	8.00	0.83	1.20	5.58	4.95	4.88	2

↑ Click on part number to see full specifications

**Packaging: 00 = waffle pack, TR = 1000pcs T&R, TR\250 = 250pcs T&R

Multilayer Organic (MLO®) Filters

MLO® High Pass Filters

HF0DA0740A7**

ELECTRICAL SPECIFICATIONS

Pass Band	0.74 - 1.47 GHz	1.2 dB	Max
	0.74 - 1.47 GHz	0.84 dB	Typ
	-3dB Cutoff	0.65 GHz	Typ
Rejection	DC - 0.54 GHz	30dB	Min
	DC - 0.52 GHz	40dB	Min
Dimension	Thickness	22 Mils	Max
RF Power	Power	2 Watts	Max

[Click here to return to main table.](#)

CLICK HERE TO DOWNLOAD DATA FILES

*Data files contain DXF and S2P files

DIMENSIONS – CASE SIZE D

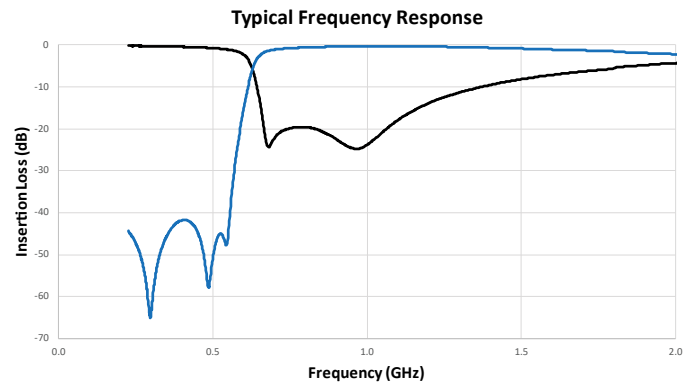
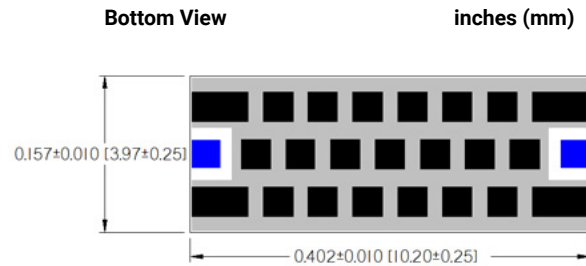

HF0BA0850A7**

ELECTRICAL SPECIFICATIONS

Pass Band	0.85 - 1.94 GHz	1.2 dB	Max
	0.85 - 1.94 GHz	0.75 dB	Typ
	-3dB Cutoff	0.77 GHz	Typ
Rejection	DC - 0.64 GHz	30 dB	Min
	DC - 0.63 GHz	40 dB	Min
Dimension	Thickness	22 Mils	Max
RF Power	Power	2 Watts	Max

[Click here to return to main table.](#)

CLICK HERE TO DOWNLOAD DATA FILES

*Data files contain DXF and S2P files

DIMENSIONS – CASE SIZE B

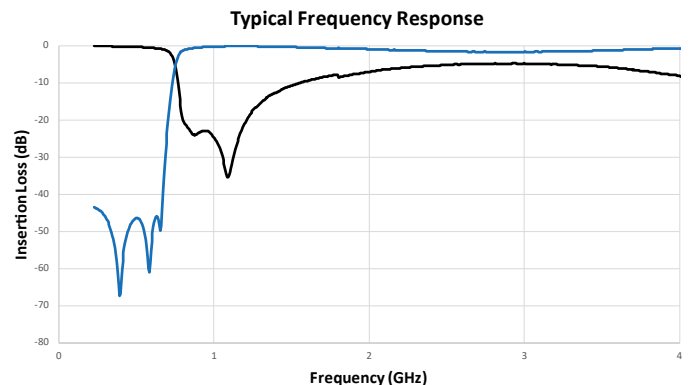
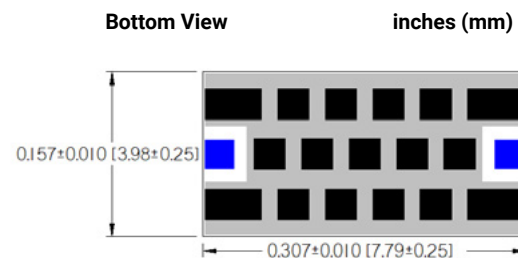

Multilayer Organic (MLO®) Filters

MLO® High Pass Filters

HF0BA0930A7**

ELECTRICAL SPECIFICATIONS

Pass Band	0.93 - 1.62 GHz	1.2 dB	Max
	0.93 - 1.62 GHz	0.87 dB	Typ
	-3dB Cutoff	0.82 GHz	Typ
Rejection	DC - 0.69 GHz	30 dB	Min
	DC - 0.68 GHz	40 dB	Min
Dimension	Thickness	22 Mils	Max
RF Power	Power	2 Watts	Max

[Click here to return to main table.](#)

CLICK HERE TO DOWNLOAD DATA FILES

*Data files contain DXF and S2P files

DIMENSIONS – CASE SIZE B

Bottom View

inches (mm)

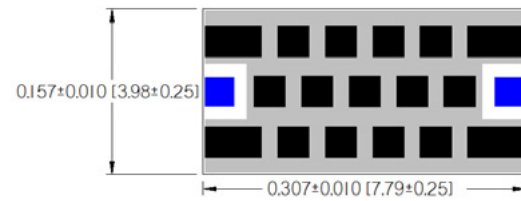

Typical Frequency Response

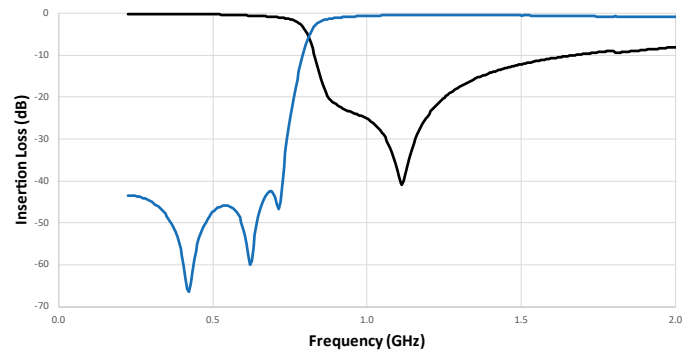

HF0BA0950A7**

ELECTRICAL SPECIFICATIONS

Pass Band	0.95 - 2.00 GHz	1.2 dB	Max
	0.95 - 2.00 GHz	0.90 dB	Typ
	-3dB Cutoff	0.85 GHz	Typ
Rejection	DC - 0.71 GHz	30 dB	Min
	DC - 0.65 GHz	40 dB	Min
Dimension	Thickness	22 Mils	Max
RF Power	Power	2 Watts	Max

[Click here to return to main table.](#)

CLICK HERE TO DOWNLOAD DATA FILES

*Data files contain DXF and S2P files

DIMENSIONS – CASE SIZE B

Bottom View

inches (mm)

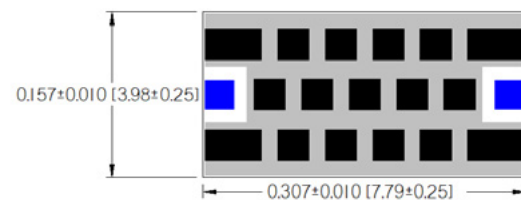

Typical Frequency Response

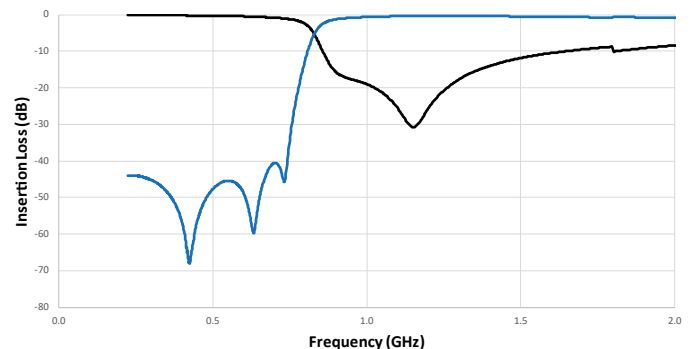

Multilayer Organic (MLO®) Filters

MLO® High Pass Filters

HF0AA1300A7**

ELECTRICAL SPECIFICATIONS

Pass Band	1.30 - 7.00 GHz	1.2 dB	Max
	1.30 - 7.00 GHz	0.53 dB	Typ
	-3dB Cutoff	1.10 GHz	Typ
Rejection	DC - 0.58 GHz	30 dB	Min
	DC - 0.50 GHz	40 dB	Min
Dimension	Thickness	22 Mils	Max
RF Power	Power	2 Watts	Max

[Click here to return to main table.](#)

CLICK HERE TO DOWNLOAD DATA FILES

*Data files contain DXF and S2P files

DIMENSIONS – CASE SIZE A

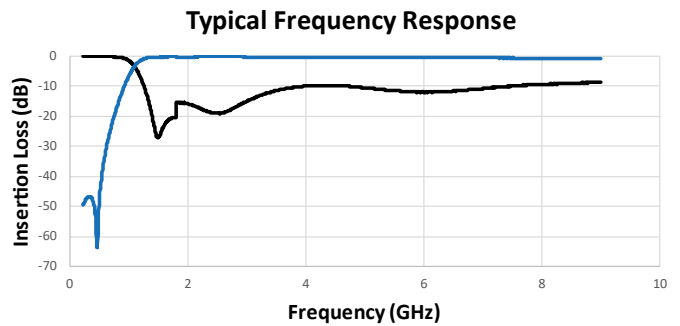
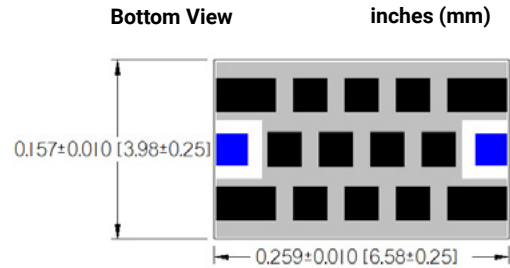

HF0AA1330A7**

ELECTRICAL SPECIFICATIONS

Pass Band	1.33 - 6.59 GHz	1.2 dB	Max
	1.33 - 6.59 GHz	0.55 dB	Typ
	-3dB Cutoff	1.12 GHz	Typ
Rejection	DC - 0.59 GHz	30 dB	Min
	DC - 0.51 GHz	40 dB	Min
Dimension	Thickness	22 Mils	Max
RF Power	Power	2 Watts	Max

[Click here to return to main table.](#)

CLICK HERE TO DOWNLOAD DATA FILES

*Data files contain DXF and S2P files

DIMENSIONS – CASE SIZE A

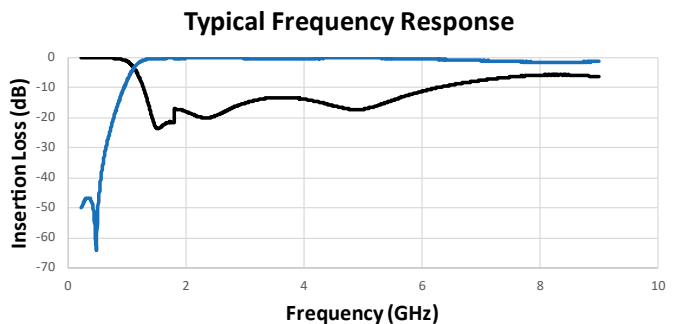
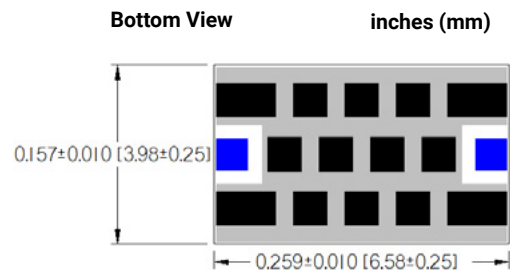

Multilayer Organic (MLO®) Filters

MLO® High Pass Filters

HF0BA1340A7**

ELECTRICAL SPECIFICATIONS

Pass Band	1.34 - 2.39 GHz	1.2 dB	Max
	1.34 - 2.39 GHz	0.74 dB	Typ
	-3dB Cutoff	1.17 GHz	Typ
Rejection	DC - 1.00 GHz	30 dB	Min
	DC - 0.97 GHz	40 dB	Min
Dimension	Thickness	22 Mils	Max
RF Power	Power	2 Watts	Max

[Click here to return to main table.](#)

CLICK HERE TO DOWNLOAD DATA FILES

*Data files contain DXF and S2P files

DIMENSIONS – CASE SIZE B

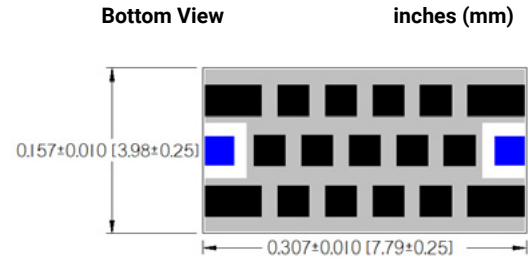

Typical Frequency Response

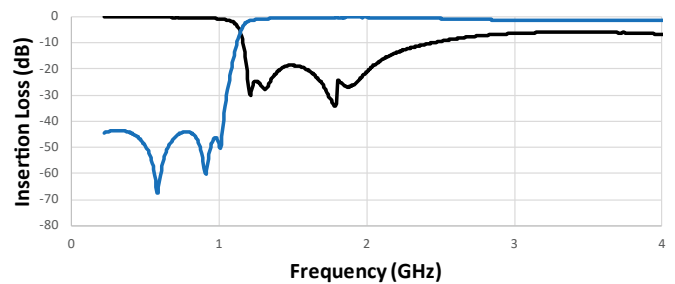

HF0BA1390A7**

ELECTRICAL SPECIFICATIONS

Pass Band	1.39 - 2.52 GHz	1.2 dB	Max
	1.39 - 2.52 GHz	0.75 dB	Typ
	-3dB Cutoff	1.21 GHz	Typ
Rejection	DC - 1.02 GHz	30 dB	Min
	DC - 1.00 GHz	40 dB	Min
Dimension	Thickness	22 Mils	Max
RF Power	Power	2 Watts	Max

[Click here to return to main table.](#)

CLICK HERE TO DOWNLOAD DATA FILES

*Data files contain DXF and S2P files

DIMENSIONS – CASE SIZE B

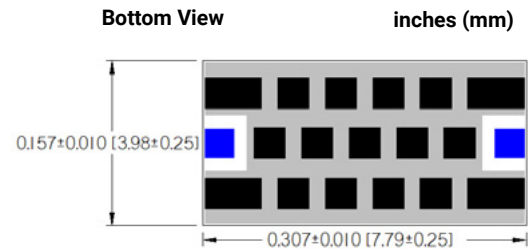

Typical Frequency Response

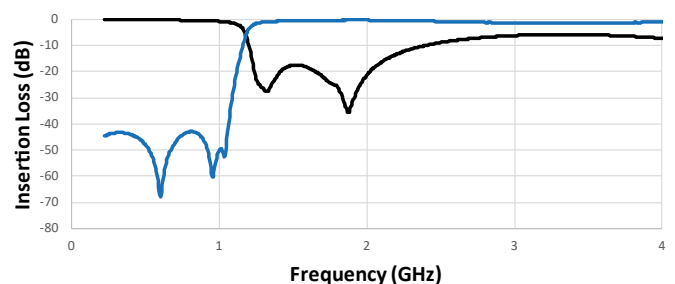

Multilayer Organic (MLO®) Filters

MLO® High Pass Filters

HF0BA1420A7**

ELECTRICAL SPECIFICATIONS

Pass Band	1.42 - 2.57 GHz	1.2 dB	Max
	1.42 - 2.57 GHz	0.70 dB	Typ
	-3dB Cutoff	1.22 GHz	Typ
Rejection	DC - 1.03 GHz	30 dB	Min
	DC - 1.00 GHz	40 dB	Min
Dimension	Thickness	22 Mils	Max
RF Power	Power	2 Watts	Max

[Click here to return to main table.](#)

CLICK HERE TO DOWNLOAD DATA FILES

*Data files contain DXF and S2P files

DIMENSIONS – CASE SIZE B

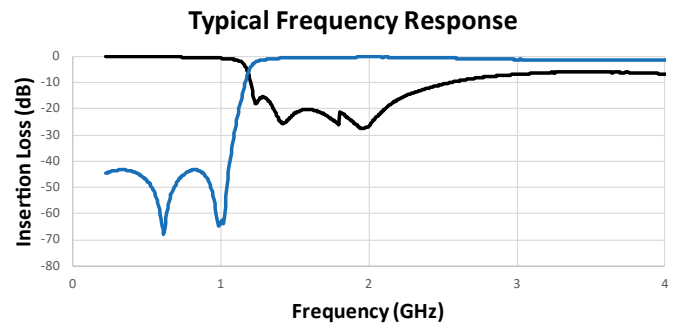
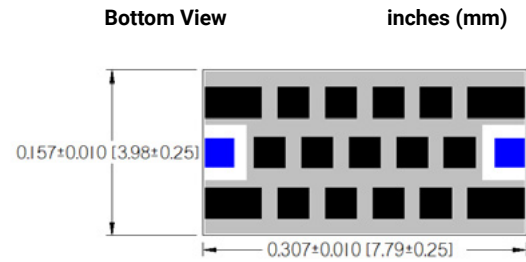

HF0BA1440A7**

ELECTRICAL SPECIFICATIONS

Pass Band	1.44 - 2.70 GHz	1.2 dB	Max
	1.44 - 2.70 GHz	0.63 dB	Typ
	-3dB Cutoff	1.22 GHz	Typ
Rejection	DC - 1.09 GHz	30 dB	Min
	DC - 1.06 GHz	40 dB	Min
Dimension	Thickness	22 Mils	Max
RF Power	Power	2 Watts	Max

[Click here to return to main table.](#)

CLICK HERE TO DOWNLOAD DATA FILES

*Data files contain DXF and S2P files

DIMENSIONS – CASE SIZE B

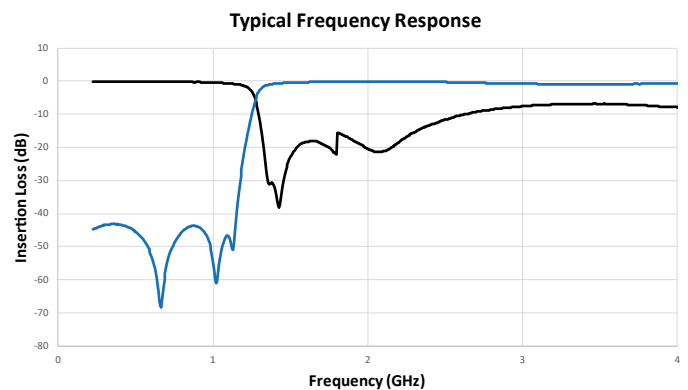
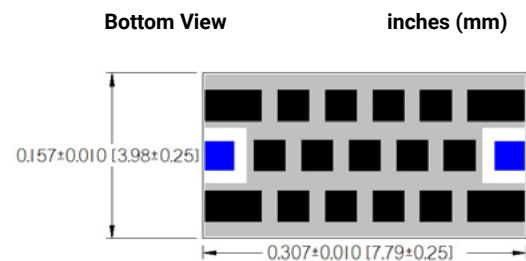

Multilayer Organic (MLO®) Filters

MLO® High Pass Filters

HF0BA1500A7**

ELECTRICAL SPECIFICATIONS

Pass Band	1.50 - 2.83 GHz	1.2 dB	Max
	1.50 - 2.83 GHz	0.75 dB	Typ
	-3dB Cutoff	1.38 GHz	Typ
Rejection	DC - 1.17 GHz	30 dB	Min
	DC - 1.15 GHz	40 dB	Min
Dimension	Thickness	22 Mils	Max
RF Power	Power	2 Watts	Max

[Click here to return to main table.](#)

CLICK HERE TO DOWNLOAD DATA FILES

*Data files contain DXF and S2P files

DIMENSIONS – CASE SIZE B

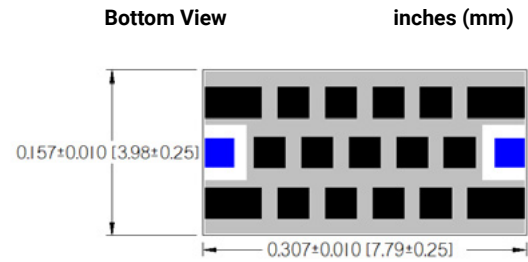

Typical Frequency Response

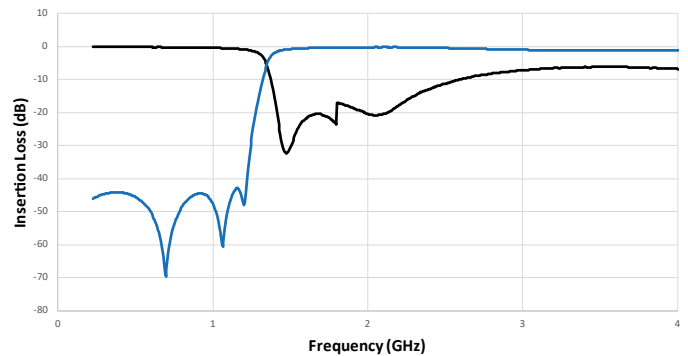

HF0BA1540A7**

ELECTRICAL SPECIFICATIONS

Pass Band	1.54 - 2.68 GHz	1.2 dB	Max
	1.54 - 2.68 GHz	0.82 dB	Typ
	-3dB Cutoff	1.39 GHz	Typ
Rejection	DC - 1.18 GHz	30 dB	Min
	DC - 1.10 GHz	40 dB	Min
Dimension	Thickness	22 Mils	Max
RF Power	Power	2 Watts	Max

[Click here to return to main table.](#)

CLICK HERE TO DOWNLOAD DATA FILES

*Data files contain DXF and S2P files

DIMENSIONS – CASE SIZE B

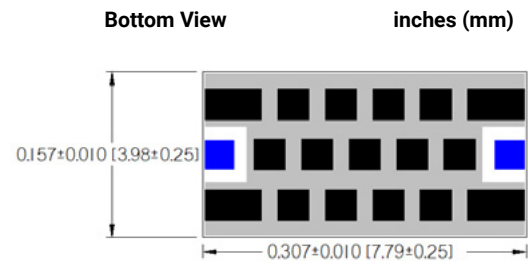

Typical Frequency Response

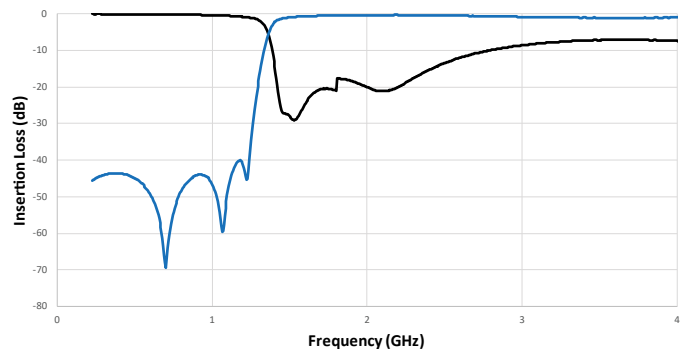

Multilayer Organic (MLO®) Filters

MLO® High Pass Filters

HF0BA1550A7**

ELECTRICAL SPECIFICATIONS

Pass Band	1.55 - 2.93 GHz	1.2 dB	Max
	1.55 - 2.93 GHz	0.82 dB	Typ
	-3dB Cutoff	1.41 GHz	Typ
Rejection	DC - 1.19GHz	30 dB	Min
	-	40 dB	Min
Dimension	Thickness	22 Mils	Max
RF Power	Power	2 Watts	Max

[Click here to return to main table.](#)

CLICK HERE TO DOWNLOAD DATA FILES

*Data files contain DXF and S2P files

DIMENSIONS – CASE SIZE B

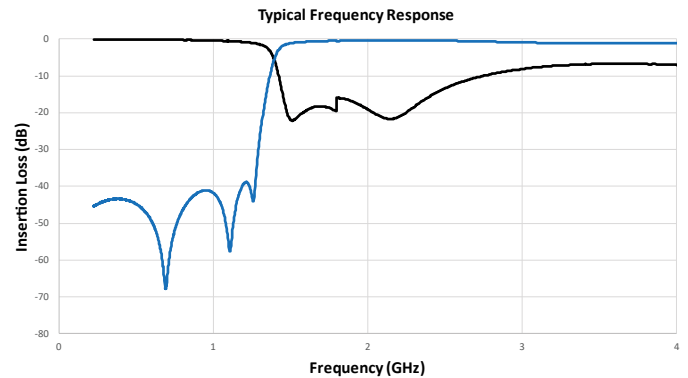
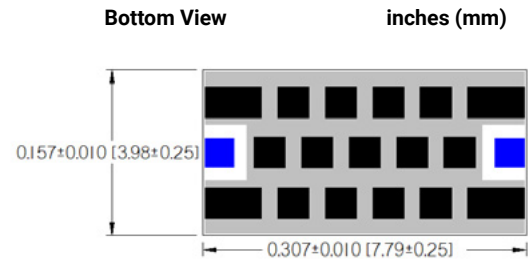

HF0AA1760A7**

ELECTRICAL SPECIFICATIONS

Pass Band	1.76 - 3.50 GHz	1.2 dB	Max
	1.76 - 3.50 GHz	0.64 dB	Typ
	-3dB Cutoff	1.49 GHz	Typ
Rejection	DC - 1.29 GHz	30 dB	Min
	DC - 1.26 GHz	40 dB	Min
Dimension	Thickness	22 Mils	Max
RF Power	Power	2 Watts	Max

[Click here to return to main table.](#)

CLICK HERE TO DOWNLOAD DATA FILES

*Data files contain DXF and S2P files

DIMENSIONS – CASE SIZE A

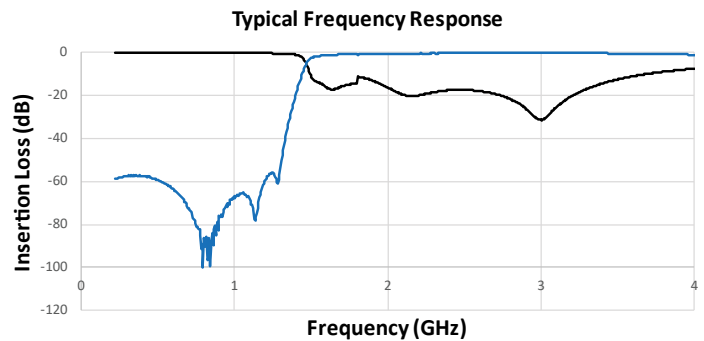
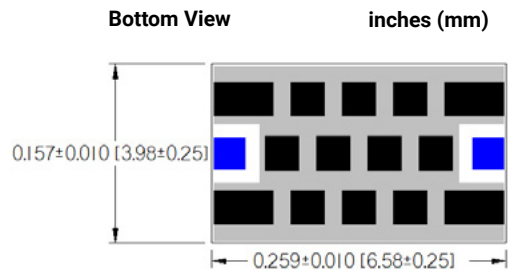

Multilayer Organic (MLO®) Filters

MLO® High Pass Filters

HF0AA1800A7**

ELECTRICAL SPECIFICATIONS

Pass Band	1.80 - 4.21 GHz	1.2 dB	Max
	1.80 - 4.21 GHz	0.76dB	Typ
	-3dB Cutoff	1.59 GHz	Typ
Rejection	DC - 1.31 GHz	30 dB	Min
	DC - 1.20 GHz	40 dB	Min
Dimension	Thickness	22 Mils	Max
RF Power	Power	2 Watts	Max

[Click here to return to main table.](#)

CLICK HERE TO DOWNLOAD DATA FILES

*Data files contain DXF and S2P files

DIMENSIONS – CASE SIZE A

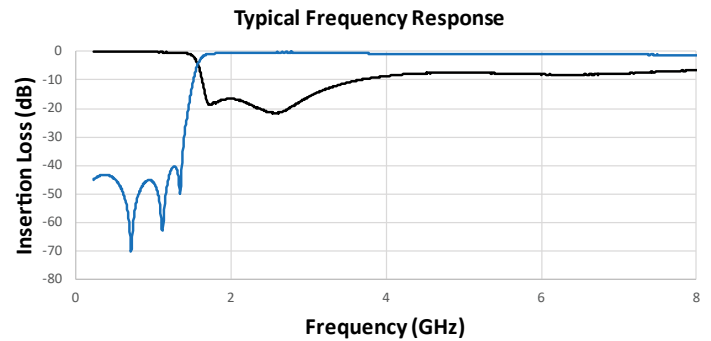
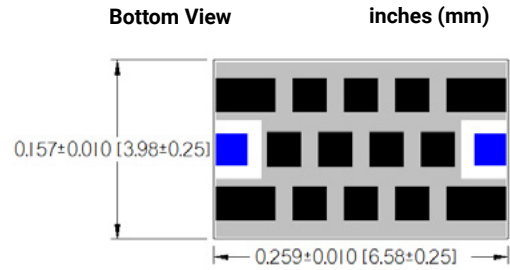

HF0BA1840A7**

ELECTRICAL SPECIFICATIONS

Pass Band	1.84 - 2.83 GHz	1.2 dB	Max
	1.84 - 2.83 GHz	0.85 dB	Typ
	-3dB Cutoff	1.66 GHz	Typ
Rejection	DC - 1.43 GHz	30 dB	Min
	DC - 1.40 GHz	40 dB	Min
Dimension	Thickness	22 Mils	Max
RF Power	Power	2 Watts	Max

[Click here to return to main table.](#)

CLICK HERE TO DOWNLOAD DATA FILES

*Data files contain DXF and S2P files

DIMENSIONS – CASE SIZE B

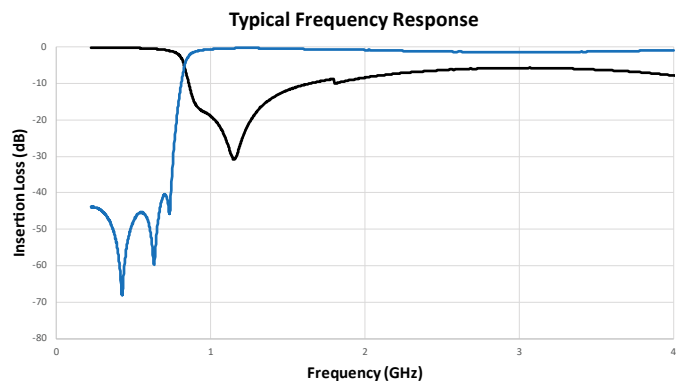
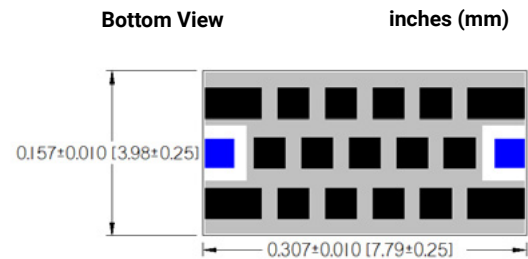

Multilayer Organic (MLO®) Filters

MLO® High Pass Filters

HF0AA2180A7**

ELECTRICAL SPECIFICATIONS

Pass Band	2.18 - 6.50 GHz	1.2 dB	Max
	2.18 - 6.50 GHz	0.73 dB	Typ
	-3dB Cutoff	1.90 GHz	Typ
Rejection	DC - 1.63 GHz	30 dB	Min
	DC - 1.60 GHz	40 dB	Min
Dimension	Thickness	22 Mils	Max
RF Power	Power	2 Watts	Max

[Click here to return to main table.](#)

CLICK HERE TO DOWNLOAD DATA FILES

*Data files contain DXF and S2P files

DIMENSIONS – CASE SIZE A

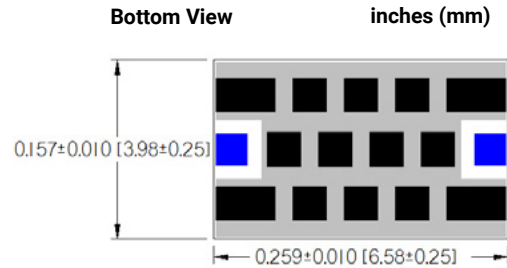

Typical Frequency Response

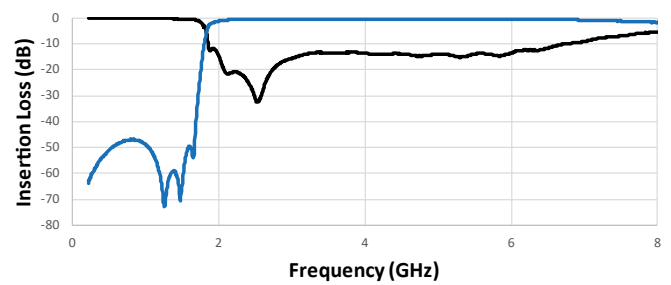

HF0AA2230A7**

ELECTRICAL SPECIFICATIONS

Pass Band	2.23 - 6.50 GHz	1.2 dB	Max
	2.23 - 6.50 GHz	0.71 dB	Typ
	-3dB Cutoff	1.93 GHz	Typ
Rejection	DC - 1.69 GHz	30 dB	Min
	DC - 1.66 GHz	40 dB	Min
Dimension	Thickness	22 Mils	Max
RF Power	Power	2 Watts	Max

[Click here to return to main table.](#)

CLICK HERE TO DOWNLOAD DATA FILES

*Data files contain DXF and S2P files

DIMENSIONS – CASE SIZE A

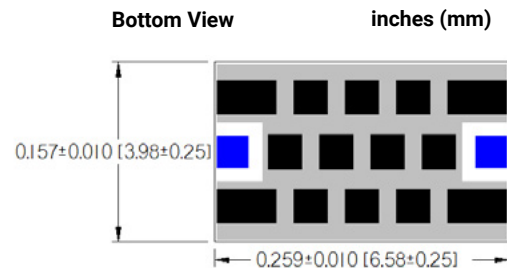

Typical Frequency Response

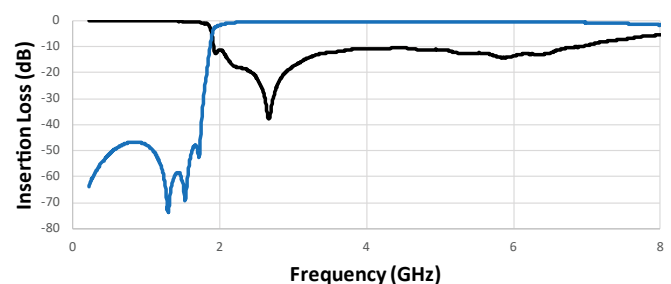

Multilayer Organic (MLO®) Filters

MLO® High Pass Filters

HF0AA2290A7**

ELECTRICAL SPECIFICATIONS

Pass Band	2.29 - 7.00 GHz	1.2 dB	Max
	2.29 - 7.00 GHz	0.73 dB	Typ
	-3dB Cutoff	1.99 GHz	Typ
Rejection	DC - 1.74 GHz	30 dB	Min
	DC - 1.71 GHz	40 dB	Min
Dimension	Thickness	22 Mils	Max
RF Power	Power	2 Watts	Max

[Click here to return to main table.](#)

CLICK HERE TO DOWNLOAD DATA FILES

*Data files contain DXF and S2P files

DIMENSIONS – CASE SIZE A

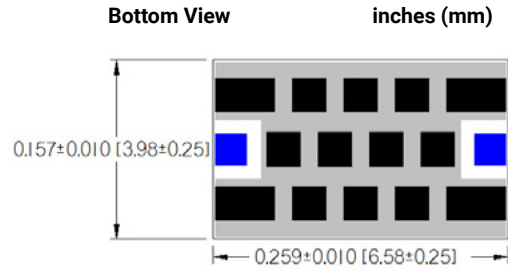

Typical Frequency Response

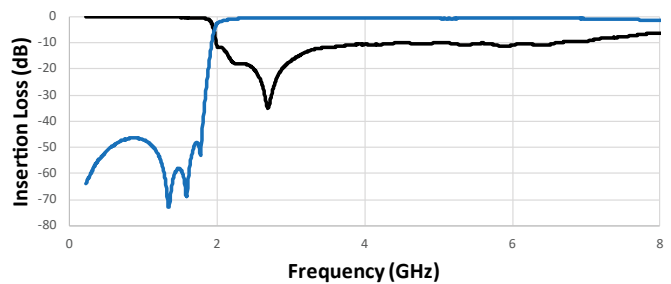

HF0AA2370A7**

ELECTRICAL SPECIFICATIONS

Pass Band	2.37 - 7.00 GHz	1.2 dB	Max
	2.37 - 7.00 GHz	0.76 dB	Typ
	-3dB Cutoff	2.06 GHz	Typ
Rejection	DC - 1.80 GHz	30 dB	Min
	DC - 1.77 GHz	40 dB	Min
Dimension	Thickness	22 Mils	Max
RF Power	Power	2 Watts	Max

[Click here to return to main table.](#)

CLICK HERE TO DOWNLOAD DATA FILES

*Data files contain DXF and S2P files

DIMENSIONS – CASE SIZE A

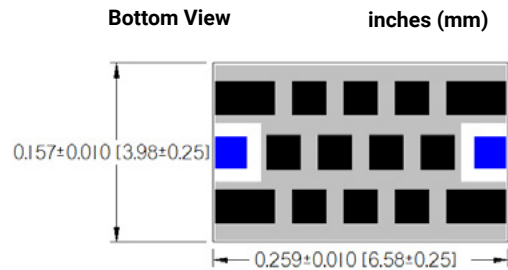

Typical Frequency Response

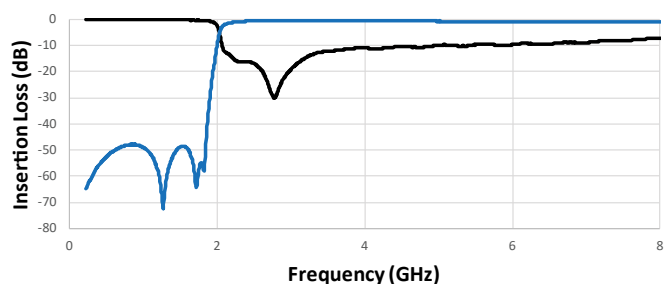

Multilayer Organic (MLO®) Filters

MLO® High Pass Filters

HF0AA2400A7**

ELECTRICAL SPECIFICATIONS

Pass Band	2.40 - 7.00 GHz	1.2 dB	Max
	2.40 - 7.00 GHz	0.61 dB	Typ
	-3dB Cutoff	2.01 GHz	Typ
Rejection	DC - 1.75 GHz	30 dB	Min
	DC - 1.71 GHz	40 dB	Min
Dimension	Thickness	22 Mils	Max
RF Power	Power	2 Watts	Max

[Click here to return to main table.](#)



CLICK HERE TO DOWNLOAD DATA FILES

*Data files contain DXF and S2P files

DIMENSIONS – CASE SIZE A

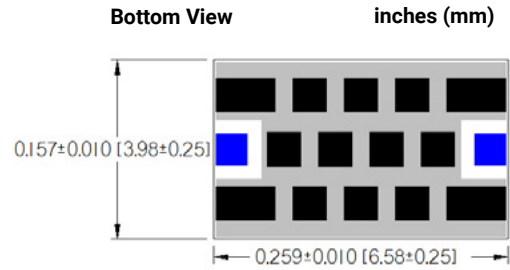

Typical Frequency Response

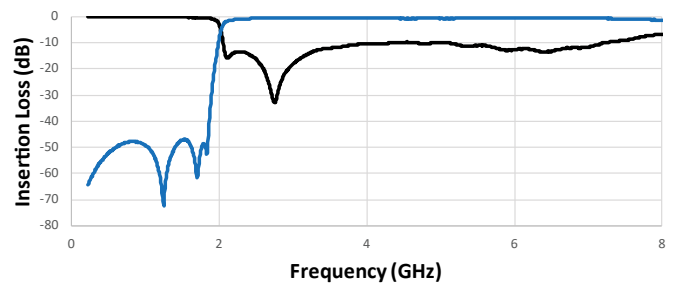

HF0AA2410A7**

ELECTRICAL SPECIFICATIONS

Pass Band	2.41 - 7.00 GHz	1.2 dB	Max
	2.41 - 7.00 GHz	0.75 dB	Typ
	-3dB Cutoff	2.08 GHz	Typ
Rejection	DC - 1.81 GHz	30 dB	Min
	DC - 1.78 GHz	40 dB	Min
Dimension	Thickness	22 Mils	Max
RF Power	Power	2 Watts	Max

[Click here to return to main table.](#)



CLICK HERE TO DOWNLOAD DATA FILES

*Data files contain DXF and S2P files

DIMENSIONS – CASE SIZE A

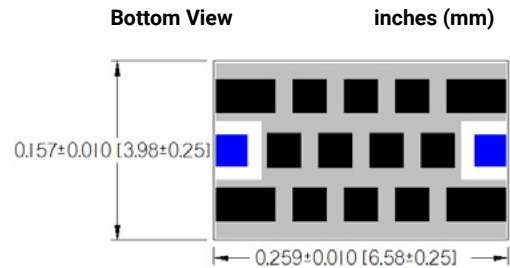

Typical Frequency Response

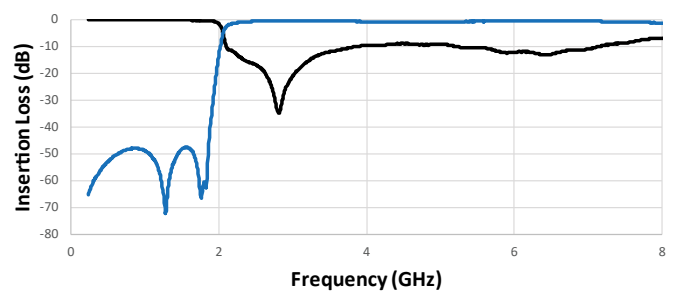

Multilayer Organic (MLO®) Filters

MLO® High Pass Filters

HF0AA2420A7**

ELECTRICAL SPECIFICATIONS

Pass Band	2.42 - 7.00 GHz	1.2 dB	Max
	2.42 - 7.00 GHz	0.73 dB	Typ
	-3dB Cutoff	2.04 GHz	Typ
Rejection	DC - 1.78 GHz	30 dB	Min
	DC - 1.75 GHz	40 dB	Min
Dimension	Thickness	22 Mils	Max
RF Power	Power	2 Watts	Max

[Click here to return to main table.](#)

[CLICK HERE TO DOWNLOAD DATA FILES](#)

*Data files contain DXF and S2P files

DIMENSIONS – CASE SIZE A

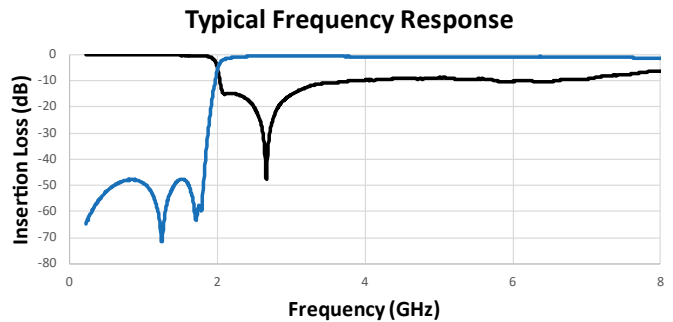
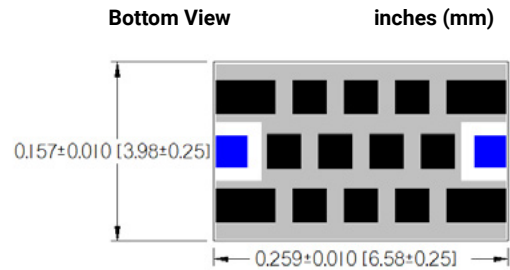

HF0AA2470A7**

ELECTRICAL SPECIFICATIONS

Pass Band	2.47 - 6.50 GHz	1.2 dB	Max
	2.47 - 6.50 GHz	0.76 dB	Typ
	-3dB Cutoff	2.13 GHz	Typ
Rejection	DC - 1.86 GHz	30 dB	Min
	DC - 1.82 GHz	40 dB	Min
Dimension	Thickness	22 Mils	Max
RF Power	Power	2 Watts	Max

[Click here to return to main table.](#)

[CLICK HERE TO DOWNLOAD DATA FILES](#)

*Data files contain DXF and S2P files

DIMENSIONS – CASE SIZE A

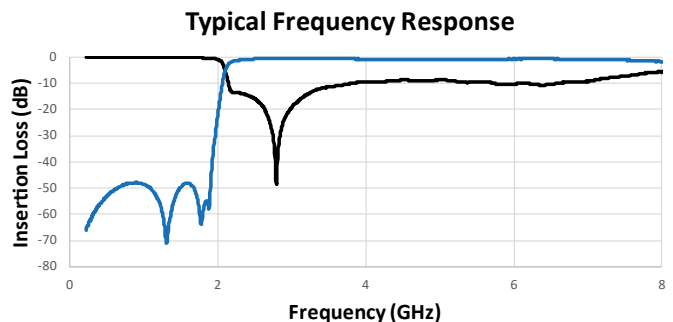
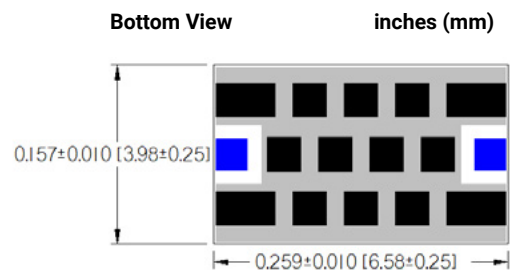

Multilayer Organic (MLO®) Filters

MLO® High Pass Filters

HF0AA2480A7**

ELECTRICAL SPECIFICATIONS

Pass Band	2.48 - 6.00 GHz	1.2 dB	Max
	2.48 - 6.00 GHz	0.71 dB	Typ
	-3dB Cutoff	2.11 GHz	Typ
Rejection	DC - 1.84 GHz	30 dB	Min
	DC - 1.81 GHz	40 dB	Min
Dimension	Thickness	22 Mils	Max
RF Power	Power	2 Watts	Max

[Click here to return to main table.](#)

CLICK HERE TO DOWNLOAD DATA FILES

*Data files contain DXF and S2P files

DIMENSIONS – CASE SIZE A

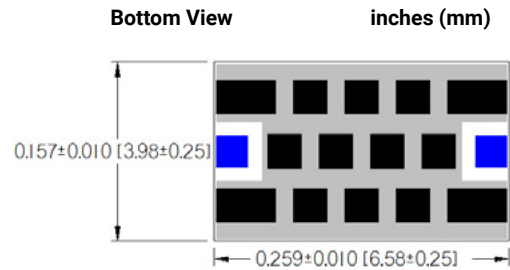

Typical Frequency Response

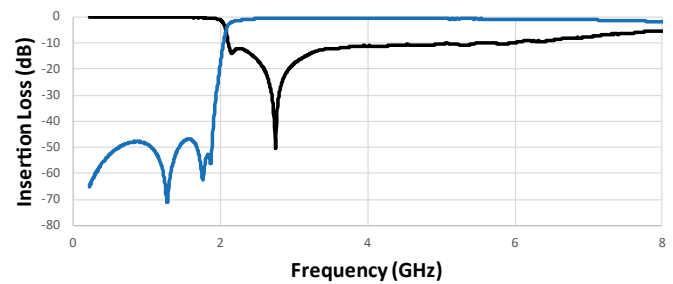

HF0AA3280A7**

ELECTRICAL SPECIFICATIONS

Pass Band	3.28 - 8.50 GHz	1.2 dB	Max
	3.28 - 8.50 GHz	0.91 dB	Typ
	-3dB Cutoff	3.02 GHz	Typ
Rejection	DC - 2.53 GHz	30 dB	Min
	DC - 2.43 GHz	40 dB	Min
Dimension	Thickness	22 Mils	Max
RF Power	Power	2 Watts	Max

[Click here to return to main table.](#)

CLICK HERE TO DOWNLOAD DATA FILES

*Data files contain DXF and S2P files

DIMENSIONS – CASE SIZE A

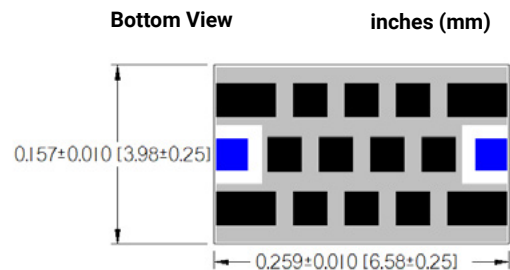

Typical Frequency Response

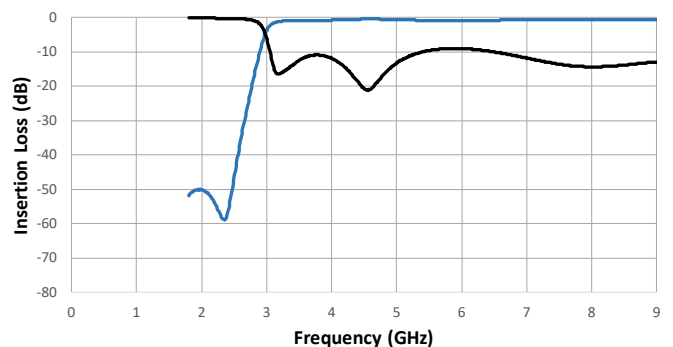

Multilayer Organic (MLO®) Filters

MLO® High Pass Filters

HF0AA3460A7**

ELECTRICAL SPECIFICATIONS

Pass Band	3.46 - 8.50 GHz	1.2 dB	Max
	3.46 - 8.50 GHz	0.75 dB	Typ
	-3dB Cutoff	3.14 GHz	Typ
Rejection	DC - 2.61 GHz	30 dB	Min
	DC - 2.52 GHz	40 dB	Min
Dimension	Thickness	22 Mils	Max
RF Power	Power	2 Watts	Max

[Click here to return to main table.](#)

CLICK HERE TO DOWNLOAD DATA FILES

*Data files contain DXF and S2P files

DIMENSIONS – CASE SIZE A

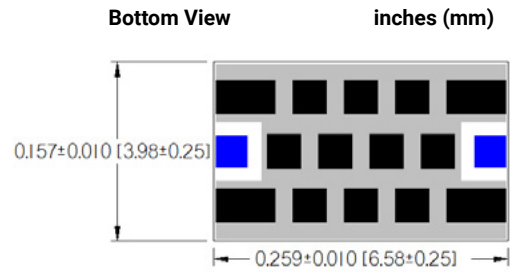

Typical Frequency Response

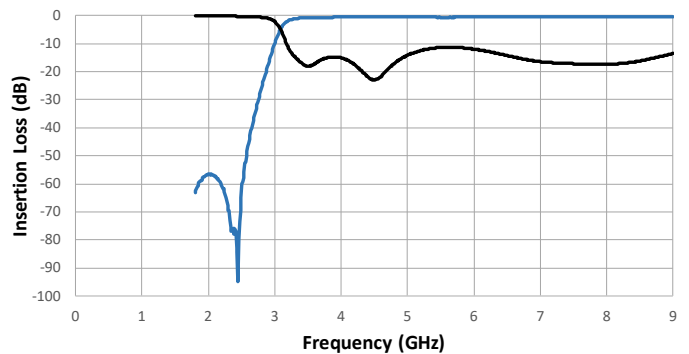

HF0AA3540A7**

ELECTRICAL SPECIFICATIONS

Pass Band	3.54 - 8.50 GHz	1.2 dB	Max
	3.54 - 8.50 GHz	0.85 dB	Typ
	-3dB Cutoff	2.92 GHz	Typ
Rejection	DC - 2.42 GHz	30 dB	Min
	DC - 2.27 GHz	40 dB	Min
Dimension	Thickness	22 Mils	Max
RF Power	Power	2 Watts	Max

[Click here to return to main table.](#)

CLICK HERE TO DOWNLOAD DATA FILES

*Data files contain DXF and S2P files

DIMENSIONS – CASE SIZE A

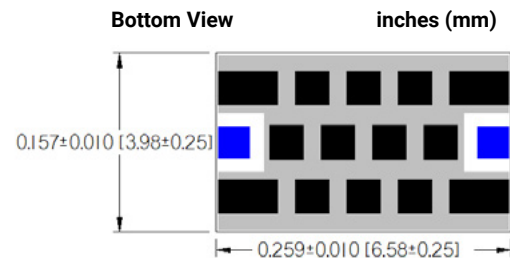

Typical Frequency Response

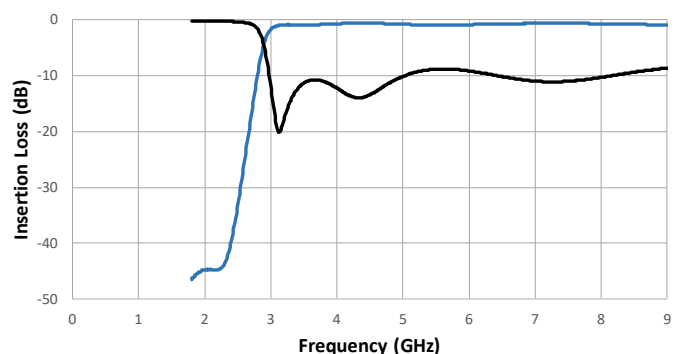

Multilayer Organic (MLO®) Filters

MLO® High Pass Filters

HF0AA4140A7**

ELECTRICAL SPECIFICATIONS

Pass Band	4.14 - 8.50 GHz	1.2 dB	Max
	4.14 - 8.50 GHz	0.66 dB	Typ
	-3dB Cutoff	3.59 GHz	Typ
Rejection	DC - 2.83 GHz	30 dB	Min
	DC - 2.71 GHz	40 dB	Min
Dimension	Thickness	22 Mils	Max
RF Power	Power	2 Watts	Max

[Click here to return to main table.](#)

CLICK HERE TO DOWNLOAD DATA FILES

*Data files contain DXF and S2P files

DIMENSIONS – CASE SIZE A

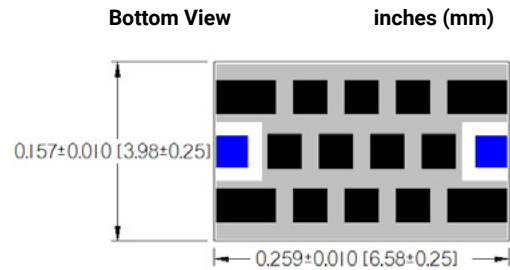

Typical Frequency Response

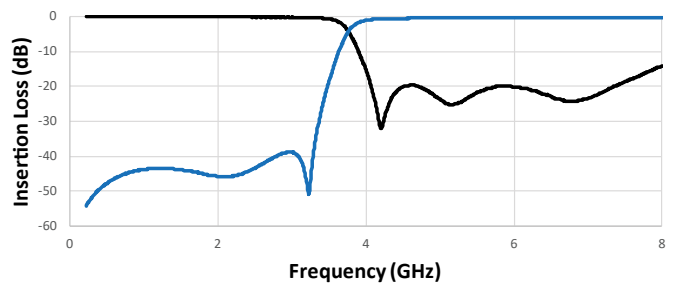

HF0AA4270A7**

ELECTRICAL SPECIFICATIONS

Pass Band	4.27 - 8.00 GHz	1.2 dB	Max
	4.27 - 8.00 GHz	0.77 dB	Typ
	-3dB Cutoff	3.76 GHz	Typ
Rejection	DC - 3.17 GHz	30 dB	Min
	-	40 dB	Min
Dimension	Thickness	22 Mils	Max
RF Power	Power	2 Watts	Max

[Click here to return to main table.](#)

CLICK HERE TO DOWNLOAD DATA FILES

*Data files contain DXF and S2P files

DIMENSIONS – CASE SIZE A

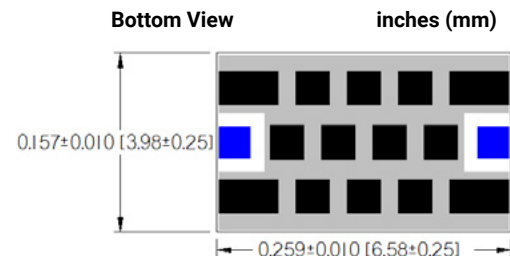

Typical Frequency Response

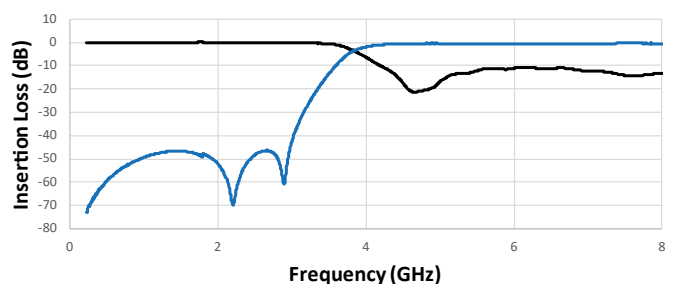

Multilayer Organic (MLO®) Filters

MLO® High Pass Filters

HF0AA4430A7**

ELECTRICAL SPECIFICATIONS

Pass Band	4.43 - 7.00 GHz	1.2 dB	Max
	4.43 - 7.00 GHz	0.61 dB	Typ
	-3dB Cutoff	3.88 GHz	Typ
Rejection	DC - 2.98 GHz	30 dB	Min
	DC - 2.86 GHz	40 dB	Min
Dimension	Thickness	22 Mils	Max
RF Power	Power	2 Watts	Max

[Click here to return to main table.](#)

[CLICK HERE TO DOWNLOAD DATA FILES](#)

*Data files contain DXF and S2P files

DIMENSIONS – CASE SIZE A

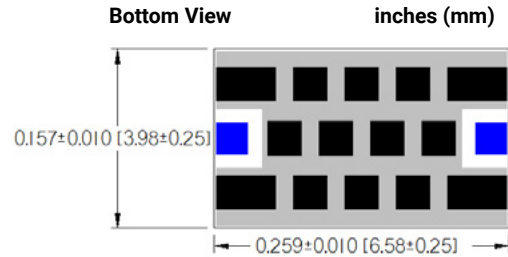

Typical Frequency Response

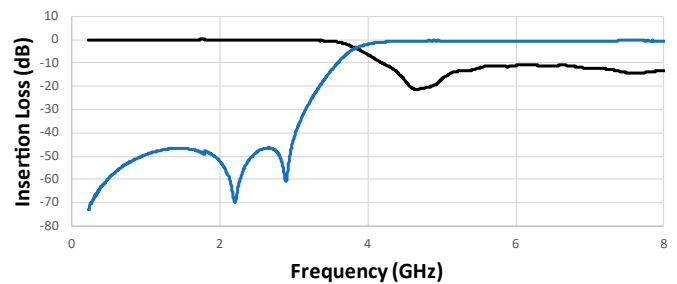

HF0AA4500A7**

ELECTRICAL SPECIFICATIONS

Pass Band	4.50 - 7.50 GHz	1.2 dB	Max
	4.50 - 7.50 GHz	0.65 dB	Typ
	-3dB Cutoff	3.93 GHz	Typ
Rejection	DC - 3.08 GHz	30 dB	Min
	DC - 2.96 GHz	40 dB	Min
Dimension	Thickness	22 Mils	Max
RF Power	Power	2 Watts	Max

[Click here to return to main table.](#)

[CLICK HERE TO DOWNLOAD DATA FILES](#)

*Data files contain DXF and S2P files

DIMENSIONS – CASE SIZE A

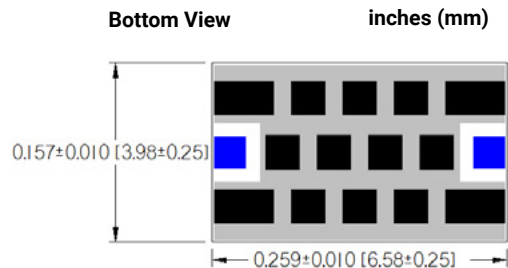

Typical Frequency Response

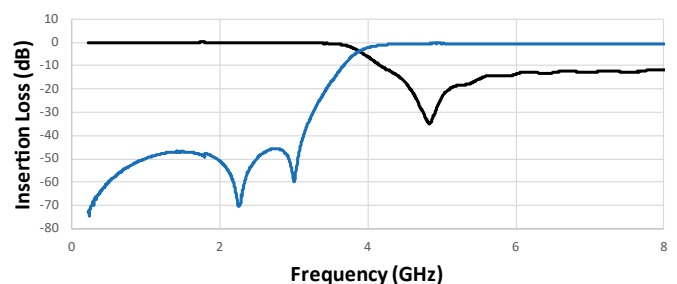

Multilayer Organic (MLO®) Filters

MLO® High Pass Filters

HF0AA4680A7**

ELECTRICAL SPECIFICATIONS

Pass Band	4.68 - 7.50 GHz	1.2 dB	Max
	4.68 - 7.50 GHz	0.62 dB	Typ
	-3dB Cutoff	4.09 GHz	Typ
Rejection	DC - 3.21 GHz	30 dB	Min
	DC - 3.08 GHz	40 dB	Min
Dimension	Thickness	22 Mils	Max
RF Power	Power	2 Watts	Max

[Click here to return to main table.](#)

[CLICK HERE TO DOWNLOAD DATA FILES](#)

*Data files contain DXF and S2P files

DIMENSIONS – CASE SIZE A

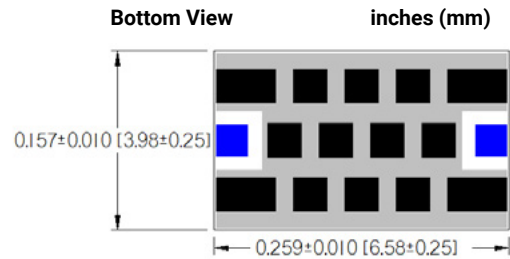

Typical Frequency Response

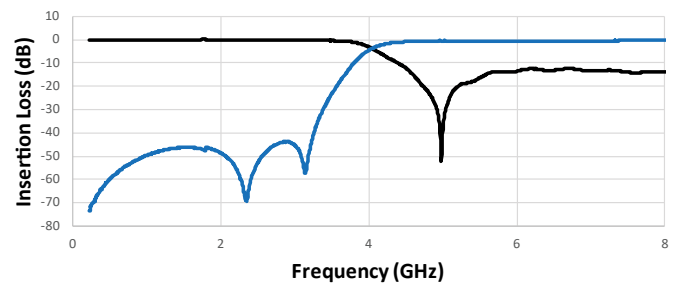

HF0AA6240A7**

ELECTRICAL SPECIFICATIONS

Pass Band	6.24 - 8.00 GHz	1.2 dB	Max
	6.24 - 8.00 GHz	0.80 dB	Typ
	-3dB Cutoff	5.37 GHz	Typ
Rejection	DC - 4.76 GHz	30 dB	Min
	DC - 4.68 GHz	40 dB	Min
Dimension	Thickness	22 Mils	Max
RF Power	Power	2 Watts	Max

[Click here to return to main table.](#)

[CLICK HERE TO DOWNLOAD DATA FILES](#)

*Data files contain DXF and S2P files

DIMENSIONS – CASE SIZE A

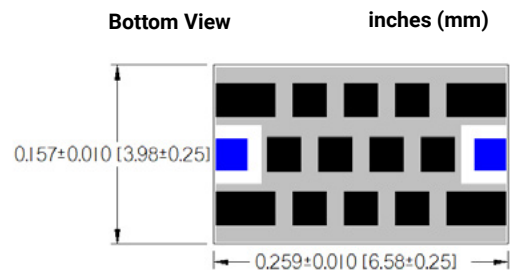

Typical Frequency Response

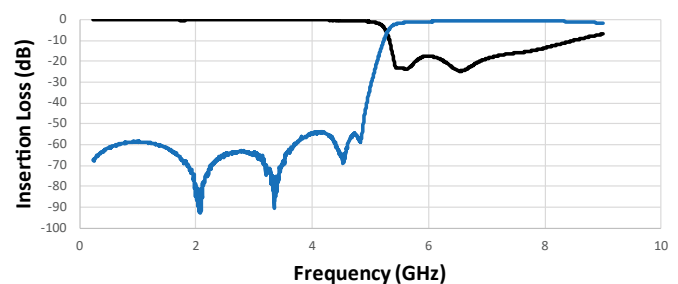

Multilayer Organic (MLO®) Filters

MLO® High Pass Filters

HF0AA6380A7**

ELECTRICAL SPECIFICATIONS

Pass Band	6.38 - 8.00GHz	1.2 dB	Max
	6.38 - 8.00GHz	0.74 dB	Typ
	-3dB Cutoff	5.28 GHz	Typ
Rejection	DC - 4.61 GHz	30 dB	Min
	DC - 4.54 GHz	40 dB	Min
Dimension	Thickness	22 Mils	Max
RF Power	Power	2 Watts	Max

[Click here to return to main table.](#)

CLICK HERE TO DOWNLOAD DATA FILES

*Data files contain DXF and S2P files

DIMENSIONS – CASE SIZE A

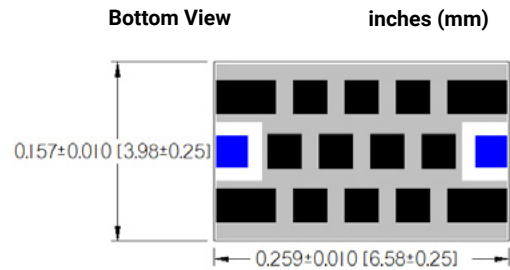

Typical Frequency Response

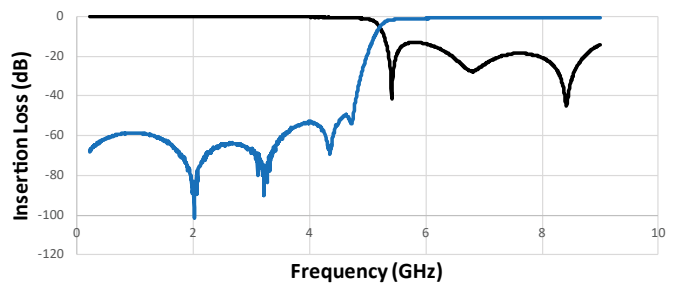

HF0AA6510A7**

ELECTRICAL SPECIFICATIONS

Pass Band	6.51 - 8.00 GHz	1.2 dB	Max
	6.51 - 8.00 GHz	0.83 dB	Typ
	-3dB Cutoff	5.58 GHz	Typ
Rejection	DC - 4.95 GHz	30 dB	Min
	DC - 4.88 GHz	40 dB	Min
Dimension	Thickness	22 Mils	Max
RF Power	Power	2 Watts	Max

[Click here to return to main table.](#)

CLICK HERE TO DOWNLOAD DATA FILES

*Data files contain DXF and S2P files

DIMENSIONS – CASE SIZE A

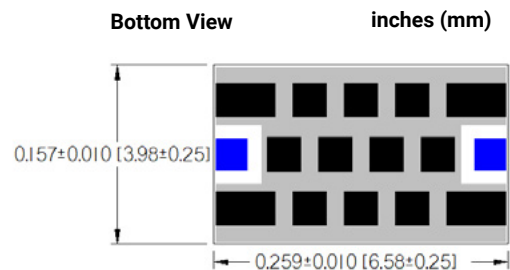

Typical Frequency Response

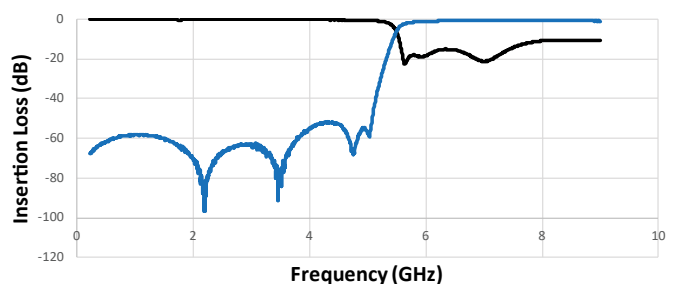

Multilayer Organic (MLO®) Filters

MLO® Low Pass Filters

General Information

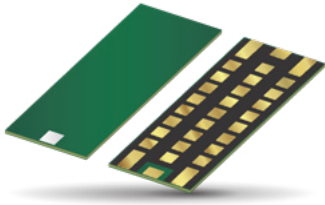

GENERAL DESCRIPTION

The MLO® Low Pass Filters are low profile passive devices with best in class performance based on KYOCERA AVX patented multilayer organic high density interconnect technology. The MLO® low pass filters utilize high dielectric constant and low loss materials to realize high Q passive printed elements, such as inductors and capacitors, in a multilayer stack. This results in a 50Ω Low Pass Filter design. MLO® Low Pass Filters can support both a variety of frequency bands and multiple wireless standards, and are less than 1.0mm in thickness. All filters are expansion matched to most organic PCB materials, thereby resulting in improved reliability over standard Si and ceramic devices.

FEATURES

- Wide Frequency Range
- Excellent Isolation
- Low Loss
- Expansion matched to PCB
- 50Ω Impedance
- Surface Mountable
- RoHS Compliant

APPLICATIONS

- Mobile Communication
- GPS
- Vehicle location systems
- Wireless LANs
- Satellite Receivers
- Instrumentation

LAND GRID ARRAY ADVANTAGES

- Inherent Low Profile
- Excellent Solderability
- Better Heat Dissipation

HOW TO ORDER

LP T Series Low Pass Filters	OB T Case Size 0A = 2616 0B = 3116 0C = 3416 0D = 4016 1E = 4617 2E = 4614 0E = 4617 0F = 5021	A T Type	1330 T Frequency In MHz	A T Standard Testing	7 T Termination 7 - Gold	00 T Package Code 00 - Standard TR - 1000 pcs Tape & Reel TR\250 - 250 pcs Tape & Reel
---	--	------------------------------	--	--	---	---

QUALITY INSPECTION

Finished Parts are 100% electrically tested

TERMINATION

All finishes are compatible with automatic soldering technologies: Pb free reflow, wave soldering, vapor phase, and manual soldering.

OPERATING TEMPERATURE

-55°C to +85°C



For RoHScompliant products, please select correct termination style



S2P FILES, DRAWING AND OTHER INFORMATION AVAILABLE IN LINK ON INDIVIDUAL DATASHEETS

Multilayer Organic (MLO®) Filters

MLO® Low Pass Filters

ELECTRICAL SPECIFICATIONS

Part Number	IL < 1.2dB Passband DC - f0 (GHz)	Passband Typical (dB)	Typical 3dB (GHz)	30dB Rejection		Power (W)	Thickness Mils
				Min (GHz)	Max (GHz)		
LP0FA0054A7**	0.054	-0.9	0.071	0.083	0.700	4 Watts	40
LP0FA0056A7**	0.057	-0.9	0.072	0.089	0.700	4 Watts	40
LP0FA0057A7**	0.057	-0.9	0.073	0.090	0.700	4 Watts	40
LP0EA0076A7**	0.076	-0.9	0.096	0.115	0.800	4 Watts	40
LP0EA0080A7**	0.080	-0.9	0.102	0.121	0.800	4 Watts	40
LP0EA0082A7**	0.082	-0.8	0.105	0.125	0.800	4 Watts	40
LP0DA0102A7**	0.102	-0.9	0.132	0.155	0.900	4 Watts	40
LP0DA0107A7**	0.107	-0.9	0.136	0.160	0.900	4 Watts	40
LP0DA0112A7**	0.112	-0.9	0.143	0.167	0.900	4 Watts	40
LP0AA0141A7**	0.141	-0.8	0.172	0.212	2.000	4 Watts	40
LP0AA0145A7**	0.145	-0.9	0.174	0.224	2.000	4 Watts	40
LP0AA0149A7**	0.149	-0.8	0.182	0.224	2.000	4 Watts	40
LP0AA0153A7**	0.153	-0.8	0.189	0.231	2.000	4 Watts	40
LP0AA0156A7**	0.156	-0.8	0.192	0.236	2.000	4 Watts	40
LP0AA0161A7**	0.161	-0.8	0.197	0.241	2.000	4 Watts	40
LP0AA0171A7**	0.171	-0.8	0.207	0.255	2.000	4 Watts	40
LP0AA0174A7**	0.174	-0.8	0.212	0.260	2.000	4 Watts	40
LP0AA0185A7**	0.185	-0.8	0.220	0.270	2.000	4 Watts	40
LP0AA0194A7**	0.194	-0.8	0.241	0.289	2.000	4 Watts	40
LP0AA0204A7**	0.204	-0.8	0.245	0.293	2.000	4 Watts	40
LP0AA0209A7**	0.209	-0.8	0.252	0.303	2.000	4 Watts	40
LP0AA0279A7**	0.279	-0.8	0.339	0.398	2.000	4 Watts	40
LP0AA0290A7**	0.290	-0.8	0.351	0.415	2.000	4 Watts	40
LP0AA0299A7**	0.299	-0.8	0.363	0.427	2.000	4 Watts	40
LP0AA0316A7**	0.316	-0.8	0.378	0.446	2.000	4 Watts	40
LP0AA0322A7**	0.322	-0.8	0.386	0.454	2.000	4 Watts	40
LP0AA0327A7**	0.327	-0.8	0.392	0.462	2.000	4 Watts	40



Click on part number to see full specifications

**Packaging: 00 = waffle pack, TR = 1000pcs T&R, TR1250 = 250pcs T&R

Multilayer Organic (MLO®) Filters

MLO® Low Pass Filters

ELECTRICAL SPECIFICATIONS

Part Number	IL < 1.2dB	Passband Typical (dB)	Typical 3dB (GHz)	30dB Rejection		40dB Rejection		Power (W)	Thickness Mils
	Passband DC - f0 (GHz)			Min (GHz)	Max (GHz)	Min (GHz)	Max (GHz)		
LP1EA0320A7**	0.320	-0.9	0.37	0.45	3.20	0.46	1.20	4	40
LP0DA0410A7**	0.410	-0.9	0.49	0.58	5.00	0.60	4.00	4	22
LP1EA0500A7**	0.500	-0.9	0.57	0.67	4.50	0.68	2.25	4	40
LP0CA0550A7**	0.550	-0.9	0.67	0.79	6.00	0.81	4.00	4	22
LP0FA0600A7**	0.600	-1.0	0.77	0.93	9.00	0.96	9.00	4	22
LP1EA0720A7**	0.720	-0.8	0.83	0.97	5.00	0.99	5.00	4	40
LP0BA0790A7**	0.790	-0.9	0.94	1.10	9.00	1.12	7.00	4	22
LP0BA0960A7**	0.960	-0.9	1.15	1.34	4.00	-	-	4	22
LP0BA1010A7**	1.010	-0.9	1.22	1.42	4.00	-	-	4	22
LP0BA1030A7**	1.030	-0.9	1.30	1.63	6.47	1.71	6	4	22
LP2EA1080A7**	1.080	-0.8	1.21	1.46	5.00	1.48	3.40	4	40
LP0BA1220A7**	1.220	-0.8	1.37	1.55	5.50	1.89	5.00	4	22
LP0BA1330A7**	1.330	-0.9	1.52	1.72	6.00	-	-	4	22
LP0BA1390A7**	1.390	-0.9	1.57	1.79	6.00	-	-	4	22
LP0AA1590A7**	1.590	-0.8	1.84	2.11	9.00	2.15	7.75	4	40
LP0AA1610A7**	1.610	-0.9	1.80	2.22	9.00	2.32	5.00	4	22
LP0AA1620A7**	1.620	-0.7	1.87	2.15	7.00	2.19	6.00	4	40
LP0AA1630A7**	1.630	-0.7	1.91	2.18	8.00	2.22	3.00	4	40
LP0AA1670A7**	1.670	-0.7	2.00	2.30	8.00	2.36	7.00	4	40
LP2EA1680A7**	1.680	-0.8	1.86	2.18	9.00	2.22	4.00	4	40
LP0AA1680A7**	1.680	-0.7	2.01	2.32	8.00	2.38	7.00	4	40
LP2EA1770A7**	1.770	-0.8	1.97	2.33	5.00	2.37	4.50	4	40
LP0DA1780A7**	1.780	-0.9	1.97	2.27	5.00	2.35	4.00	4	40
LP0DA1800A7**	1.800	-0.8	2.02	2.30	6.00	2.40	4.00	4	40
LP0DA1810A7**	1.810	-0.8	2.04	2.29	6.00	2.48	4.00	4	40
LP0DA1840A7**	1.840	-0.7	2.04	2.27	5.50	2.44	4.00	4	40
LP0DA1880A7**	1.880	-0.8	2.05	2.28	6.00	2.42	4.00	4	40
LP0DA1890A7**	1.890	-0.8	2.13	2.38	7.00	-	-	4	40
LP0DA1950A7**	1.950	-0.8	2.20	2.53	8.00	-	-	4	40
LP0DA2100A7**	2.100	-0.8	2.37	2.68	9.00	2.72	5.11	4	22
LP0DA2140A7**	2.140	-0.7	2.38	2.68	9.00	2.72	5.23	4	22
LP0DA2160A7**	2.160	-0.8	2.41	2.72	5.00	-	-	4	22
LP0DA2190A7**	2.190	-0.6	2.44	2.79	6.50	2.93	4.00	4	40
LP0DA2200A7**	2.200	-0.8	2.50	2.84	5.00	4.00	5.00	4	22
LP0DA2210A7**	2.210	-0.8	2.60	2.98	8.50	3.25	4.25	4	40
LP0DA2260A7**	2.260	-0.8	2.50	2.86	5.00	4.00	5.00	4	22
LP0AA2300A7**	2.300	-0.9	2.56	3.15	9.00	3.26	9.00	4	22
LP0AA2490A7**	2.490	-0.7	2.80	3.98	9.00	3.79	5.00	4	40
LP2EA2530A7**	2.530	-0.7	2.87	3.28	9.00	3.32	6.50	4	40
LP0AA2590A7**	2.590	-0.7	2.89	3.71	9.00	3.87	5.20	4	40
LP2EA2600A7**	2.600	-0.7	2.95	3.40	9.00	3.50	6.00	4	40
LP0AA2640A7**	2.640	-0.8	2.97	3.82	9.00	3.98	5.50	4	40
LP0AA2910A7**	2.910	-0.8	3.43	4.07	9.00	4.80	8.00	4	22
LP0AA2980A7**	2.980	-0.7	3.52	4.17	9.00	4.29	8.00	4	22
LP0AA3100A7**	3.100	-0.7	3.65	4.32	9.00	5.00	8.00	4	22
LP0AA3160A7**	3.160	-0.8	3.47	4.36	9.00	4.47	9.00	4	22
LP0AA4080A7**	4.080	-0.7	5.03	5.62	9.00	5.69	9.00	4	22
LP0AA4150A7**	4.150	-0.6	5.16	5.75	9.00	5.82	9.00	4	22
LP0AA4210A7**	4.210	-0.7	5.28	5.87	9.00	6.16	9.00	4	22
LP0AA4370A7**	4.370	-0.8	4.84	6.00	9.00	6.32	9.00	4	22
LP0AA6160A7**	6.160	-0.9	7.09	8.59	13.00	8.82	11.50	4	22

 Click on part number to see full specifications

**Packaging: 00 = waffle pack, TR = 1000pcs T&R, TR1250 = 250pcs T&R

Multilayer Organic (MLO®) Filters

MLO® Low Pass Filters

LP1EA0320A7**

ELECTRICAL SPECIFICATIONS

Pass Band	DC - 0.320 GHz	1.2 dB	Max
	DC - 0.320 GHz	0.9 dB	Typ
	3dB Cutoff	0.37 GHz	Typ
Rejection	0.45 - 3.20 GHz	30dB	Min
	0.46 - 1.20 GHz	40dB	Min
Dimension	Thickness	40 Mils	Max
RF Power	Power	4 Watts	Max

[Click here to return to main table.](#)

CLICK HERE TO DOWNLOAD DATA FILES

*Data files contain DXF and S2P files

DIMENSIONS – CASE SIZE 1E

Bottom View

inches (mm)

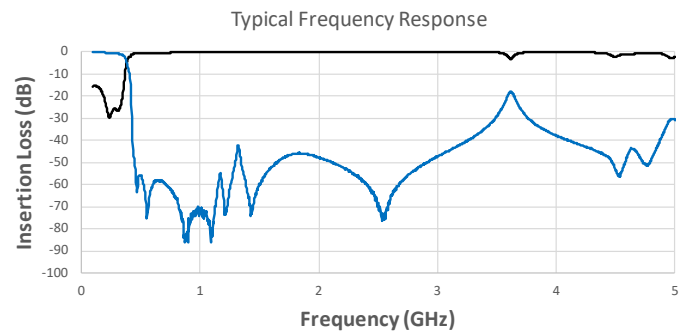
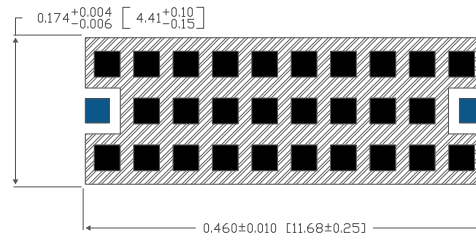

LP0DA0410A7**

ELECTRICAL SPECIFICATIONS

Pass Band	DC - 0.410 GHz	1.2 dB	Max
	DC - 0.410 GHz	0.9 dB	Typ
	3dB Cutoff	0.49 GHz	Typ
Rejection	0.58 - 5.00 GHz	30dB	Min
	0.60 - 4.00 GHz	40dB	Min
Dimension	Thickness	22 Mils	Max
RF Power	Power	4 Watts	Max

[Click here to return to main table.](#)

CLICK HERE TO DOWNLOAD DATA FILES

*Data files contain DXF and S2P files

DIMENSIONS – CASE SIZE D

Bottom View

inches (mm)

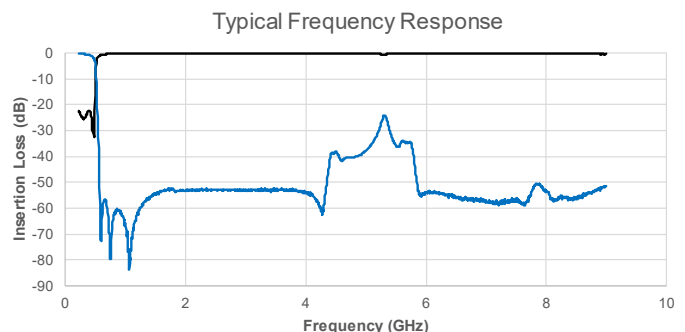
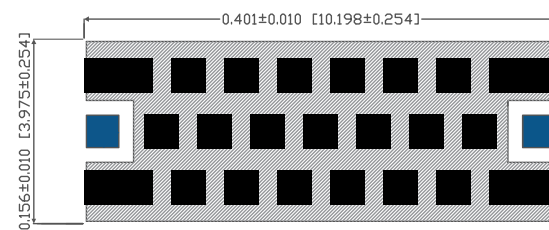

Multilayer Organic (MLO®) Filters

MLO® Low Pass Filters

LP1EA0500A7**

ELECTRICAL SPECIFICATIONS

Pass Band	DC - 0.500 GHz	1.2 dB	Max
	DC - 0.500 GHz	0.9 dB	Typ
	3dB Cutoff	0.57 GHz	Typ
Rejection	0.67 - 4.50 GHz	30dB	Min
	0.68 - 2.25 GHz	40dB	Min
Dimension	Thickness	40 Mils	Max
RF Power	Power	4 Watts	Max

[Click here to return to main table.](#)



CLICK HERE TO DOWNLOAD DATA FILES

*Data files contain DXF and S2P files

DIMENSIONS – CASE SIZE 1E

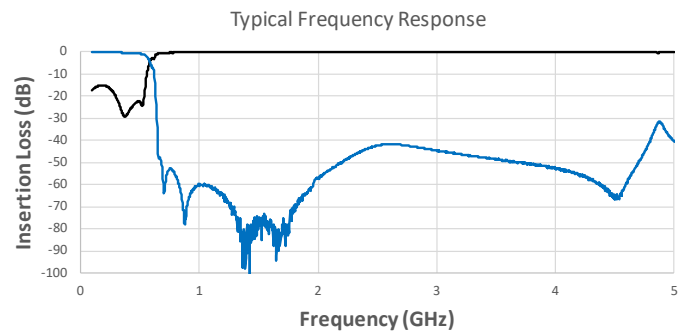
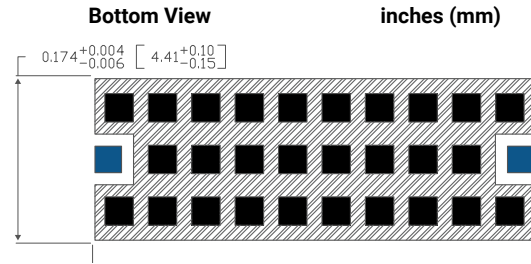

LP0CA0550A7**

ELECTRICAL SPECIFICATIONS

Pass Band	DC - 0.550 GHz	1.2 dB	Max
	DC - 0.550 GHz	0.9 dB	Typ
	3dB Cutoff	0.67 GHz	Typ
Rejection	0.79 - 6.00 GHz	30dB	Min
	0.81 - 4.00 GHz	40dB	Min
Dimension	Thickness	22 Mils	Max
RF Power	Power	4 Watts	Max

[Click here to return to main table.](#)



CLICK HERE TO DOWNLOAD DATA FILES

*Data files contain DXF and S2P files

DIMENSIONS – CASE SIZE C

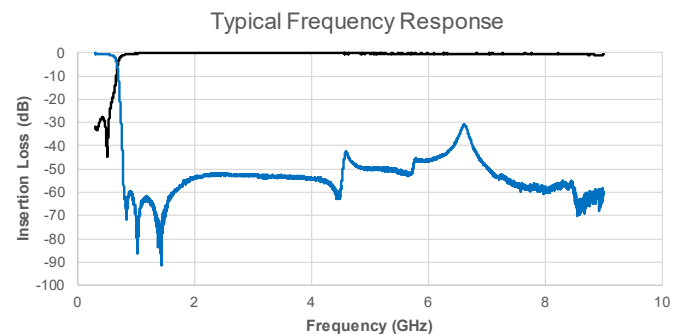
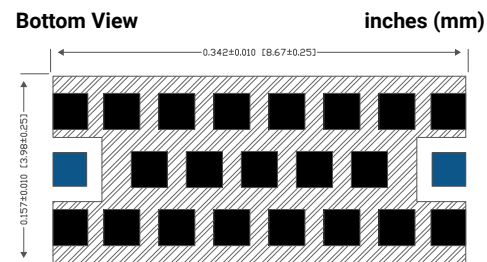

Multilayer Organic (MLO®) Filters

MLO® Low Pass Filters

LP0FA0600A7**

ELECTRICAL SPECIFICATIONS

Pass Band	DC - 0.600 GHz	1.2 dB	Max
	DC - 0.600 GHz	1.0 dB	Typ
	3dB Cutoff	0.77 GHz	Typ
Rejection	0.93 - 9.00 GHz	30dB	Min
	0.96 - 9.00 GHz	40dB	Min
Dimension	Thickness	22 Mils	Max
RF Power	Power	4 Watts	Max

[Click here to return to main table.](#)

CLICK HERE TO DOWNLOAD DATA FILES

*Data files contain DXF and S2P files

DIMENSIONS – CASE SIZE F

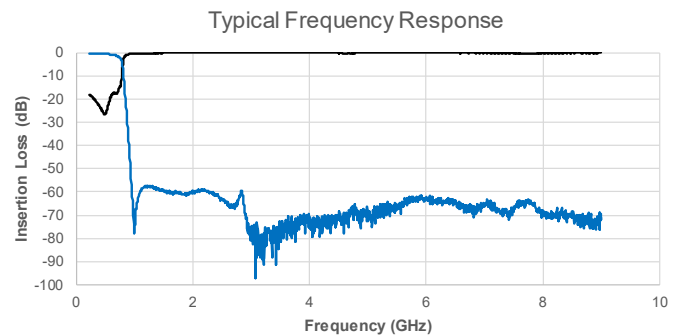
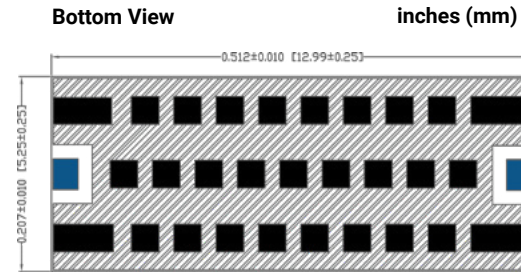

LP1EA0720A7**

ELECTRICAL SPECIFICATIONS

Pass Band	DC - 0.720 GHz	1.2 dB	Max
	DC - 0.720 GHz	0.8 dB	Typ
	3dB Cutoff	0.83 GHz	Typ
Rejection	0.97 - 5.00 GHz	30dB	Min
	0.99 - 5.00 GHz	40dB	Min
Dimension	Thickness	40 Mils	Max
RF Power	Power	4 Watts	Max

[Click here to return to main table.](#)

CLICK HERE TO DOWNLOAD DATA FILES

*Data files contain DXF and S2P files

DIMENSIONS – CASE SIZE 1E

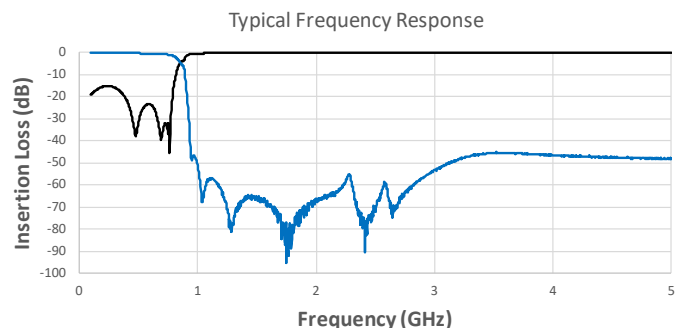
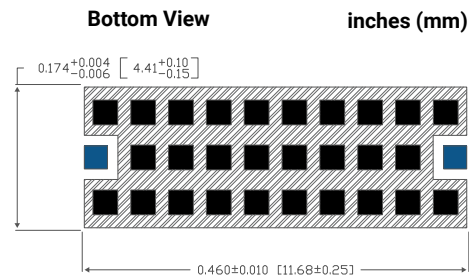

Multilayer Organic (MLO®) Filters

MLO® Low Pass Filters

LP0BA0790A7**

ELECTRICAL SPECIFICATIONS

Pass Band	DC - 0.790 GHz	1.2 dB	Max
	DC - 0.795 GHz	0.9 dB	Typ
	3dB Cutoff	0.94 GHz	Typ
Rejection	1.10 - 9.00 GHz	30dB	Min
	1.12 - 7.00 GHz	40dB	Min
Dimension	Thickness	22 Mils	Max
	RF Power	Power	4 Watts
			Max

[Click here to return to main table.](#)

CLICK HERE TO DOWNLOAD DATA FILES

*Data files contain DXF and S2P files

DIMENSIONS – CASE SIZE B

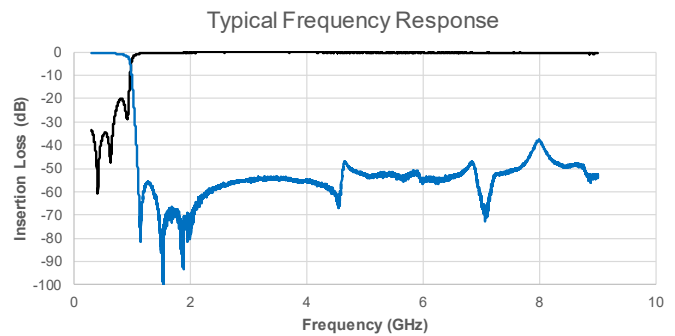
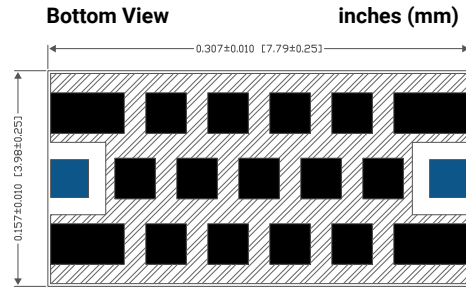

LP0BA0960A7**

ELECTRICAL SPECIFICATIONS

Pass Band	DC - 0.960 GHz	1.2 dB	Max
	DC - 0.960 GHz	0.9 dB	Typ
	3dB Cutoff	1.15 GHz	Typ
Rejection	1.34 - 4.00 GHz	30dB	Min
	- GHz	40dB	Min
Dimension	Thickness	22 Mils	Max
	RF Power	Power	4 Watts
			Max

[Click here to return to main table.](#)

CLICK HERE TO DOWNLOAD DATA FILES

*Data files contain DXF and S2P files

DIMENSIONS – CASE SIZE B

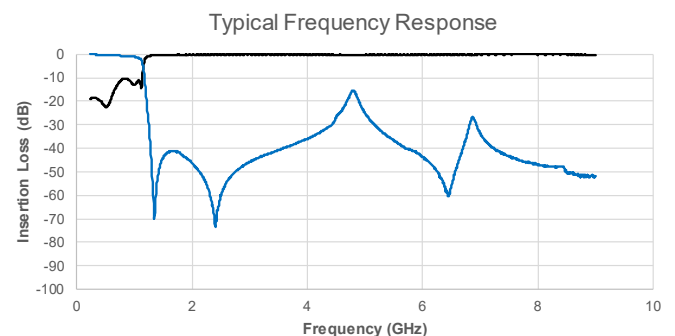
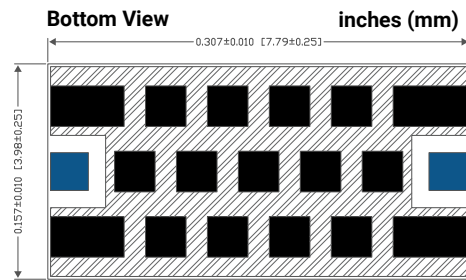

Multilayer Organic (MLO®) Filters

MLO® Low Pass Filters

LP0BA1010A7**

ELECTRICAL SPECIFICATIONS

Pass Band	DC - 1.010 GHz	1.2 dB	Max
	DC - 1.010 GHz	0.9 dB	Typ
	3dB Cutoff	1.22 GHz	Typ
Rejection	1.42 - 4.00 GHz	30dB	Min
	- GHz	40dB	Min
Dimension	Thickness	22 Mils	Max
RF Power	Power	4 Watts	Max

[Click here to return to main table.](#)

CLICK HERE TO DOWNLOAD DATA FILES

*Data files contain DXF and S2P files

DIMENSIONS – CASE SIZE B

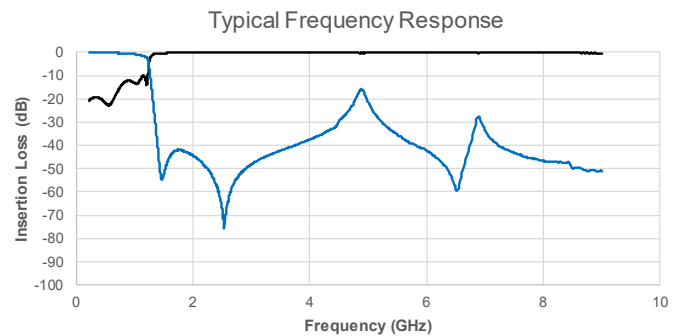
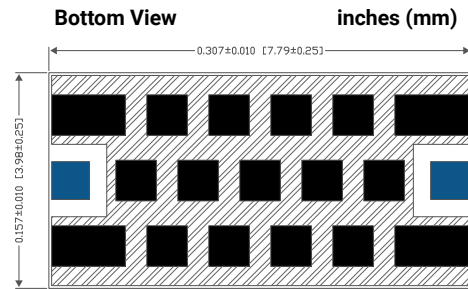

LP0BA1030A7**

ELECTRICAL SPECIFICATIONS

Pass Band	DC - 1.030 GHz	1.2 dB	Max
	DC - 1.030 GHz	0.9 dB	Typ
	3dB Cutoff	1.30 GHz	Typ
Rejection	1.63 - 6.47 GHz	30dB	Min
	1.71 - 6 GHz	40dB	Min
Dimension	Thickness	22 Mils	Max
RF Power	Power	4 Watts	Max

[Click here to return to main table.](#)

CLICK HERE TO DOWNLOAD DATA FILES

*Data files contain DXF and S2P files

DIMENSIONS – CASE SIZE B

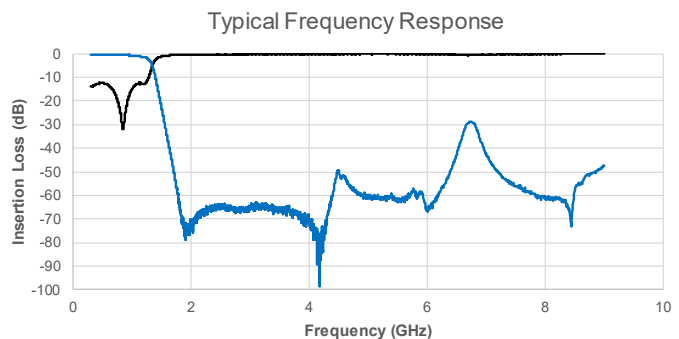
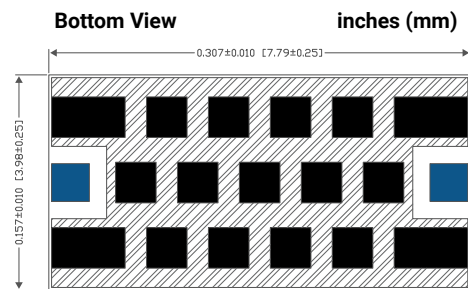

Multilayer Organic (MLO®) Filters

MLO® Low Pass Filters

LP2EA1080A7**

ELECTRICAL SPECIFICATIONS

Pass Band	DC - 1.080 GHz	1.2 dB	Max
	DC - 1.080 GHz	0.8 dB	Typ
	3dB Cutoff	1.21 GHz	Typ
Rejection	1.46 - 5.00 GHz	30dB	Min
	1.48 - 3.40 GHz	40dB	Min
Dimension	Thickness	40 Mils	Max
RF Power	Power	4 Watts	Max

[Click here to return to main table.](#)

CLICK HERE TO DOWNLOAD DATA FILES

*Data files contain DXF and S2P files

DIMENSIONS – CASE SIZE 2E

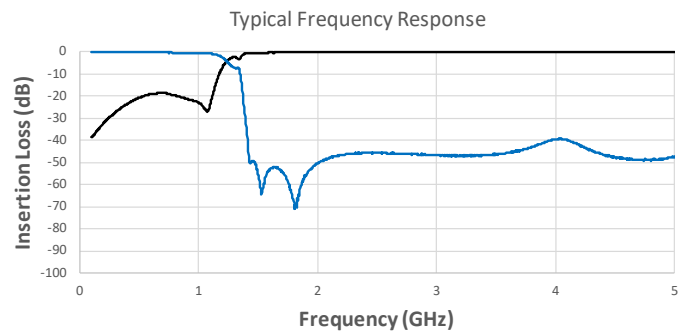
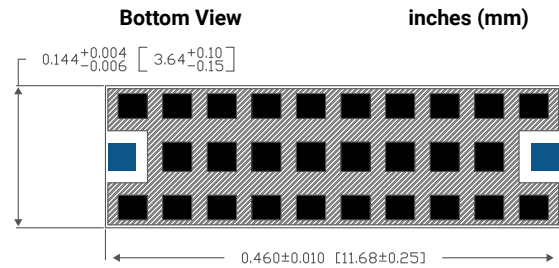

LP0BA1220A7**

ELECTRICAL SPECIFICATIONS

Pass Band	DC - 1.220 GHz	1.2 dB	Max
	DC - 1.220 GHz	0.8 dB	Typ
	3dB Cutoff	1.37 GHz	Typ
Rejection	1.55 - 5.50 GHz	30dB	Min
	1.89 - 5.00 GHz	40dB	Min
Dimension	Thickness	22 Mils	Max
RF Power	Power	4 Watts	Max

[Click here to return to main table.](#)

CLICK HERE TO DOWNLOAD DATA FILES

*Data files contain DXF and S2P files

DIMENSIONS – CASE SIZE B

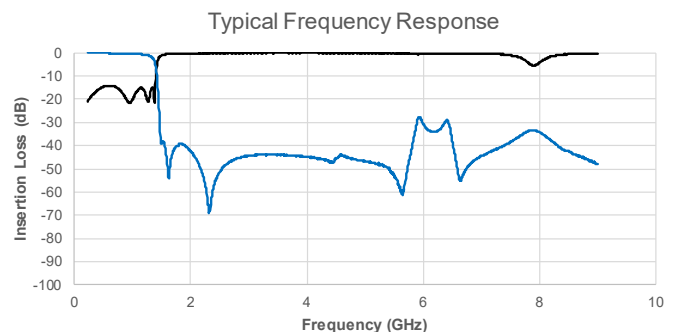
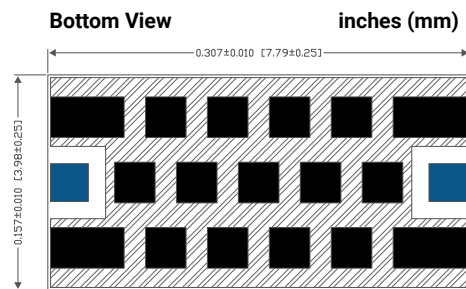

Multilayer Organic (MLO®) Filters

MLO® Low Pass Filters

LP0BA1330A7**

ELECTRICAL SPECIFICATIONS

Pass Band	DC - 1.330 GHz	1.2 dB	Max
	DC - 1.330 GHz	0.9 dB	Typ
	3dB Cutoff	1.52 GHz	Typ
Rejection	1.72 - 6.00 GHz	30dB	Min
	- GHz	40dB	Min
Dimension	Thickness	22 Mils	Max
RF Power	Power	4 Watts	Max

[Click here to return to main table.](#)

CLICK HERE TO DOWNLOAD DATA FILES

*Data files contain DXF and S2P files

DIMENSIONS – CASE SIZE B

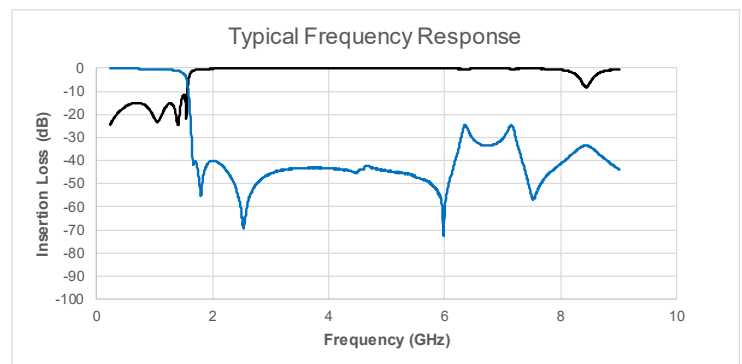
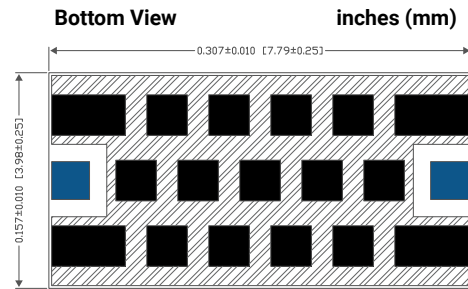

LP0BA1390A7**

ELECTRICAL SPECIFICATIONS

Pass Band	DC - 1.390 GHz	1.2 dB	Max
	DC - 1.390 GHz	0.9 dB	Typ
	3dB Cutoff	1.57 GHz	Typ
Rejection	1.79 - 6.00 GHz	30dB	Min
	- GHz	40dB	Min
Dimension	Thickness	22 Mils	Max
RF Power	Power	4 Watts	Max

[Click here to return to main table.](#)

CLICK HERE TO DOWNLOAD DATA FILES

*Data files contain DXF and S2P files

DIMENSIONS – CASE SIZE B

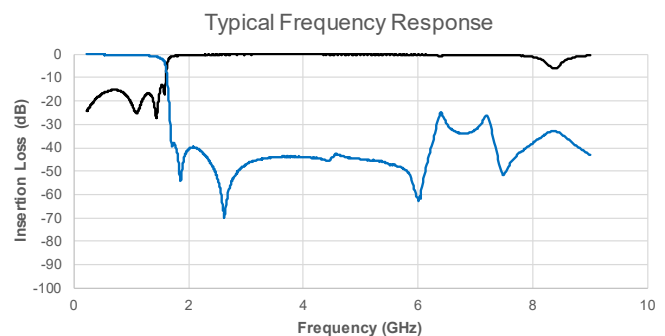
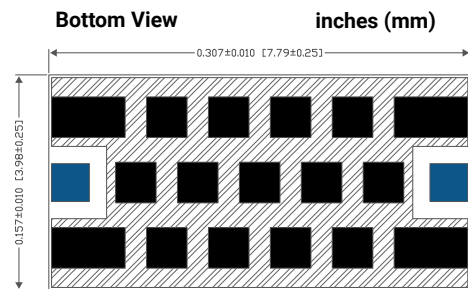

Multilayer Organic (MLO®) Filters

MLO® Low Pass Filters

LP0AA1590A7**

ELECTRICAL SPECIFICATIONS

Pass Band	DC - 1.590 GHz	1.2 dB	Max
	DC - 1.590 GHz	0.8 dB	Typ
	3dB Cutoff	1.84 GHz	Typ
Rejection	2.11 - 9.00 GHz	30dB	Min
	2.15 - 7.75 GHz	40dB	Min
Dimension	Thickness	40 Mils	Max
	RF Power	Power	4 Watts
			Max

[Click here to return to main table.](#)



CLICK HERE TO DOWNLOAD DATA FILES

*Data files contain DXF and S2P files

DIMENSIONS – CASE SIZE A

Bottom View inches (mm)

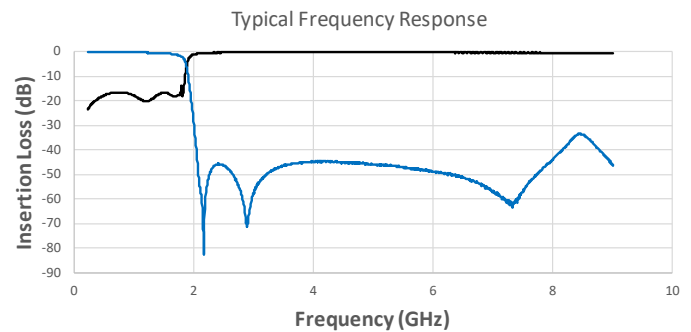
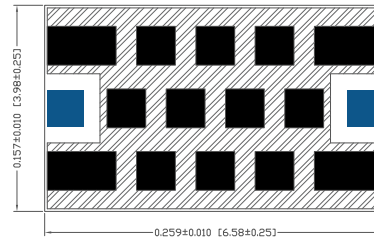

LP0AA1610A7**

ELECTRICAL SPECIFICATIONS

Pass Band	DC - 1.610 GHz	1.2 dB	Max
	DC - 1.610 GHz	0.9 dB	Typ
	3dB Cutoff	1.80 GHz	Typ
Rejection	2.22 - 9.00 GHz	30dB	Min
	2.32 - 5.00 GHz	40dB	Min
Dimension	Thickness	22 Mils	Max
	RF Power	Power	4 Watts
			Max

[Click here to return to main table.](#)



CLICK HERE TO DOWNLOAD DATA FILES

*Data files contain DXF and S2P files

DIMENSIONS – CASE SIZE A

Bottom View inches (mm)

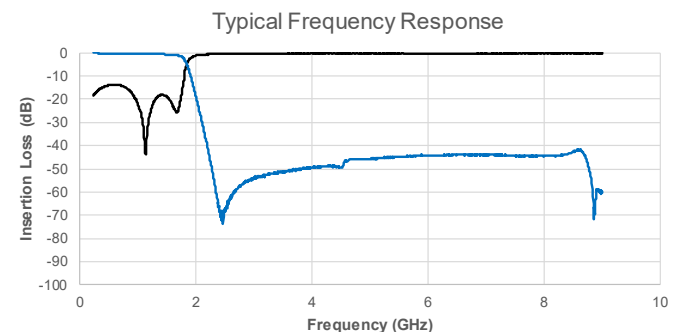
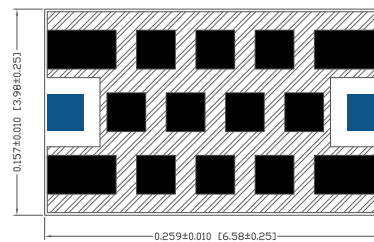

Multilayer Organic (MLO®) Filters

MLO® Low Pass Filters

LP0AA1620A7**

ELECTRICAL SPECIFICATIONS

Pass Band	DC - 1.620 GHz	1.2 dB	Max
	DC - 1.620 GHz	0.7 dB	Typ
	3dB Cutoff	1.87 GHz	Typ
Rejection	2.15 - 7.00 GHz	30dB	Min
	2.19 - 6.00 GHz	40dB	Min
Dimension	Thickness	40 Mils	Max
	RF Power	Power	4 Watts
			Max

[Click here to return to main table.](#)

CLICK HERE TO DOWNLOAD DATA FILES

*Data files contain DXF and S2P files

DIMENSIONS – CASE SIZE A

Bottom View inches (mm)

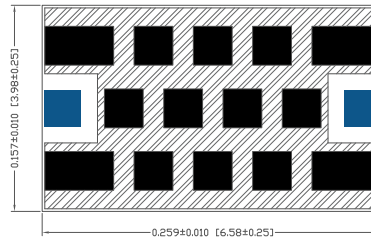

Typical Frequency Response

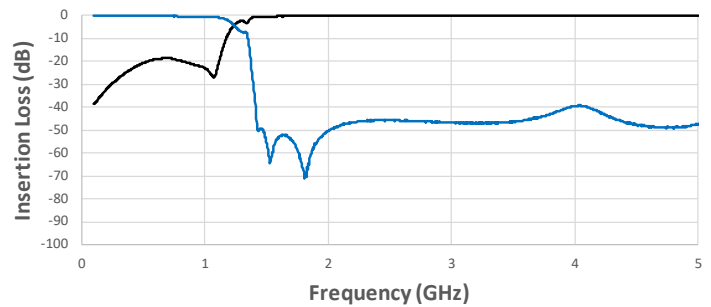

LP0AA1630A7**

ELECTRICAL SPECIFICATIONS

Pass Band	DC - 1.630 GHz	1.2 dB	Max
	DC - 1.630 GHz	0.7 dB	Typ
	3dB Cutoff	1.91 GHz	Typ
Rejection	2.18 - 8.00 GHz	30dB	Min
	2.22 - 3.00 GHz	40dB	Min
Dimension	Thickness	40 Mils	Max
	RF Power	Power	4 Watts
			Max

[Click here to return to main table.](#)

CLICK HERE TO DOWNLOAD DATA FILES

*Data files contain DXF and S2P files

DIMENSIONS – CASE SIZE A

Bottom View inches (mm)

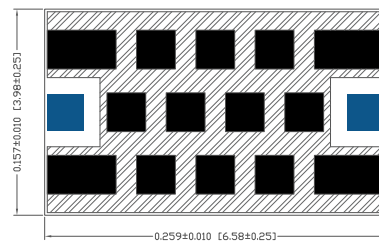

Typical Frequency Response

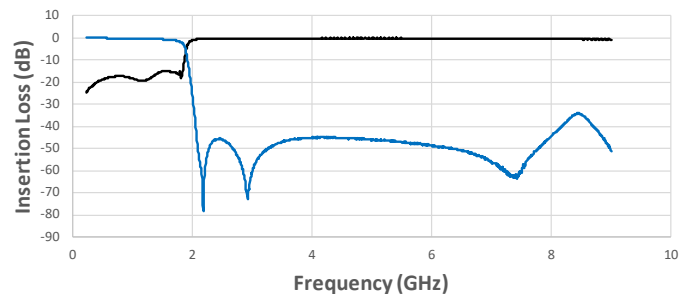

Multilayer Organic (MLO®) Filters

MLO® Low Pass Filters

LP0AA1670A7**

ELECTRICAL SPECIFICATIONS

Pass Band	DC - 1.670 GHz	1.2 dB	Max
	DC - 1.670 GHz	0.7 dB	Typ
	3dB Cutoff	2.00 GHz	Typ
Rejection	2.30 - 8.00 GHz	30dB	Min
	2.36 - 7.00 GHz	40dB	Min
Dimension	Thickness	40 Mils	Max
RF Power	Power	4 Watts	Max

[Click here to return to main table.](#)

CLICK HERE TO DOWNLOAD DATA FILES

*Data files contain DXF and S2P files

DIMENSIONS – CASE SIZE A

Bottom View inches (mm)

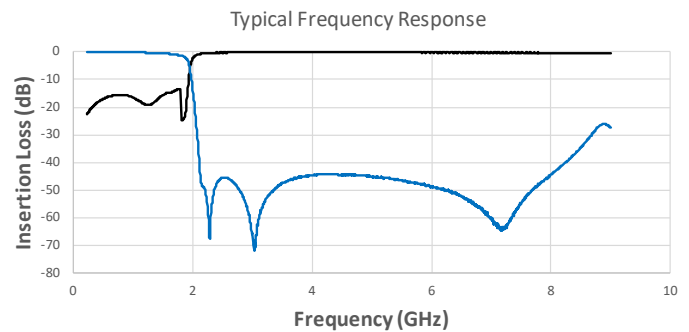
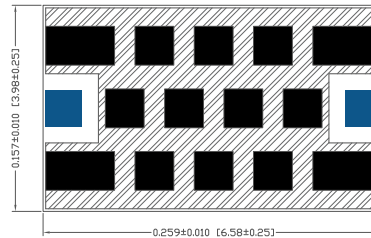

LP2EA1680A7**

ELECTRICAL SPECIFICATIONS

Pass Band	DC - 1.680 GHz	1.2 dB	Max
	DC - 1.680 GHz	0.8 dB	Typ
	3dB Cutoff	1.86 GHz	Typ
Rejection	2.18 - 9.00 GHz	30dB	Min
	2.22 - 4.00 GHz	40dB	Min
Dimension	Thickness	40 Mils	Max
RF Power	Power	4 Watts	Max

[Click here to return to main table.](#)

CLICK HERE TO DOWNLOAD DATA FILES

*Data files contain DXF and S2P files

DIMENSIONS – CASE SIZE 2E

Bottom View inches (mm)

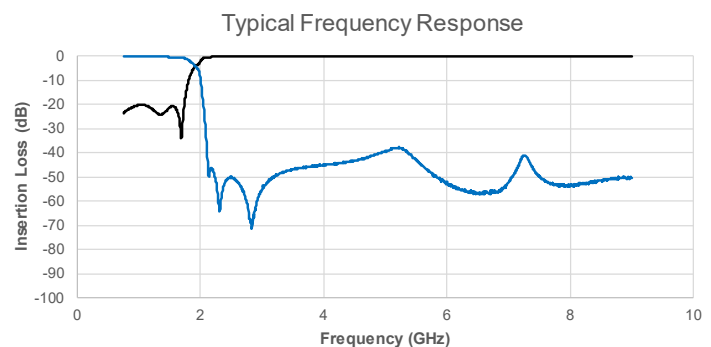
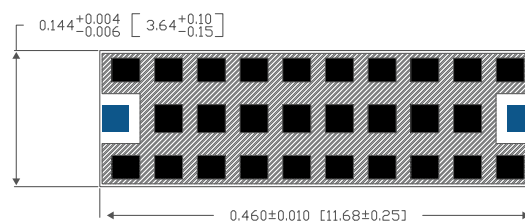

Multilayer Organic (MLO®) Filters

MLO® Low Pass Filters

LP0AA1680A7**

ELECTRICAL SPECIFICATIONS

Pass Band	DC - 1.680 GHz	1.2 dB	Max
	DC - 1.680 GHz	0.7 dB	Typ
	3dB Cutoff	2.01 GHz	Typ
Rejection	2.32 - 8.00 GHz	30dB	Min
	2.38 - 7.00 GHz	40dB	Min
Dimension	Thickness	40 Mils	Max
	RF Power	Power	4 Watts
			Max

[Click here to return to main table.](#)

CLICK HERE TO DOWNLOAD DATA FILES

*Data files contain DXF and S2P files

DIMENSIONS – CASE SIZE A

Bottom View inches (mm)

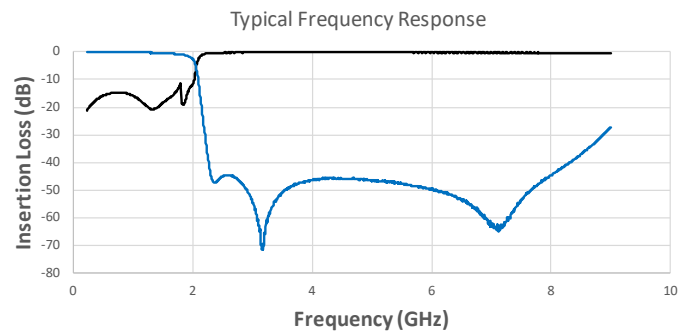
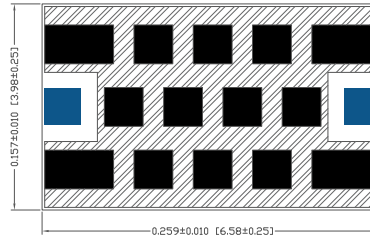

LP2EA1770A7**

ELECTRICAL SPECIFICATIONS

Pass Band	DC - 1.770 GHz	1.2 dB	Max
	DC - 1.770 GHz	0.8 dB	Typ
	3dB Cutoff	1.97 GHz	Typ
Rejection	2.33 - 5.00 GHz	30dB	Min
	2.37 - 4.50 GHz	40dB	Min
Dimension	Thickness	40 Mils	Max
	RF Power	Power	4 Watts
			Max

[Click here to return to main table.](#)

CLICK HERE TO DOWNLOAD DATA FILES

*Data files contain DXF and S2P files

DIMENSIONS – CASE SIZE 2E

Bottom View inches (mm)

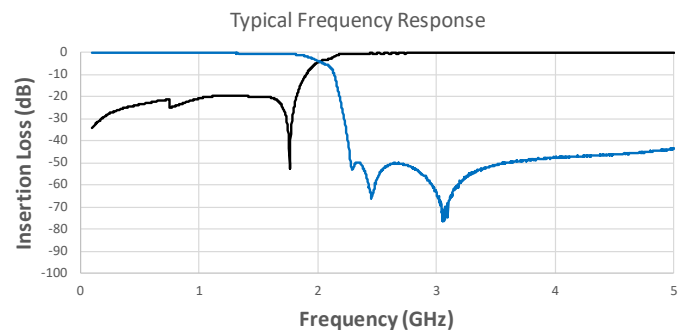
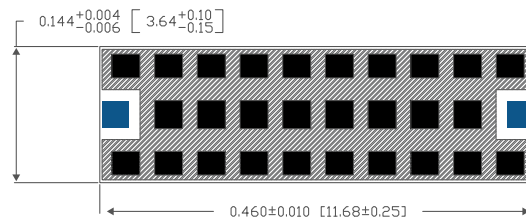

Multilayer Organic (MLO®) Filters

MLO® Low Pass Filters

LP0DA1780A7**

ELECTRICAL SPECIFICATIONS

Pass Band	DC - 1.780 GHz	1.2 dB	Max
	DC - 1.780 GHz	0.9 dB	Typ
	3dB Cutoff	1.97 GHz	Typ
Rejection	2.27 - 5.00 GHz	30dB	Min
	2.35 - 4.00 GHz	40dB	Min
Dimension	Thickness	40 Mils	Max
RF Power	Power	4 Watts	Max

[Click here to return to main table.](#)

CLICK HERE TO DOWNLOAD DATA FILES

*Data files contain DXF and S2P files

DIMENSIONS – CASE SIZE D

Bottom View inches (mm)

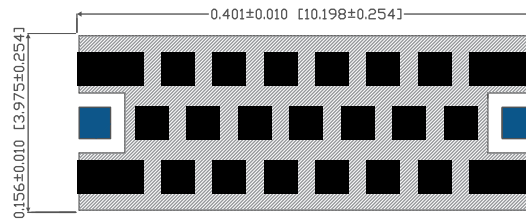

Typical Frequency Response

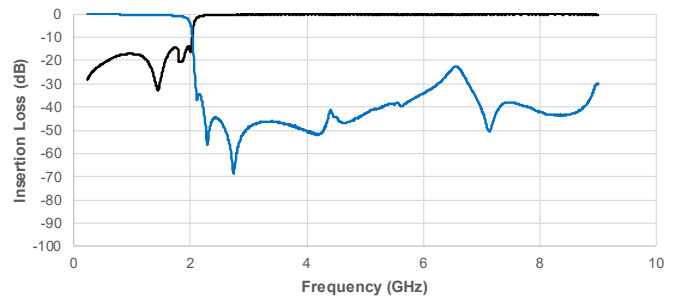

LP0DA1800A7**

ELECTRICAL SPECIFICATIONS

Pass Band	DC - 1.800 GHz	1.2 dB	Max
	DC - 1.800 GHz	0.8 dB	Typ
	3dB Cutoff	2.02 GHz	Typ
Rejection	2.30 - 6.00 GHz	30dB	Min
	2.40 - 4.00 GHz	40dB	Min
Dimension	Thickness	40Mils	Max
RF Power	Power	4 Watts	Max

[Click here to return to main table.](#)

CLICK HERE TO DOWNLOAD DATA FILES

*Data files contain DXF and S2P files

DIMENSIONS – CASE SIZE D

Bottom View inches (mm)

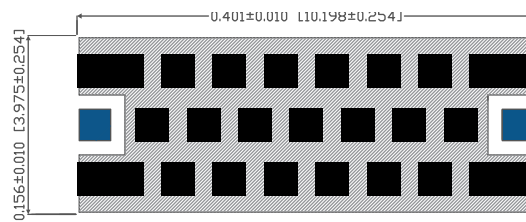

Typical Frequency Response

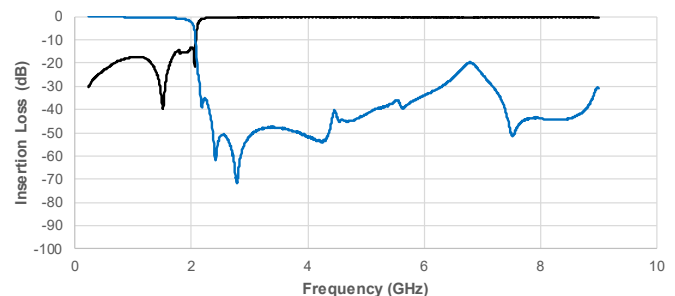

Multilayer Organic (MLO®) Filters

MLO® Low Pass Filters

LP0DA1810A7**

ELECTRICAL SPECIFICATIONS

Pass Band	DC - 1.810 GHz	1.2 dB	Max
	DC - 1.810 GHz	0.8 dB	Typ
	3dB Cutoff	2.04 GHz	Typ
Rejection	2.29 - 6.00 GHz	30dB	Min
	2.48 - 4.00 GHz	40dB	Min
Dimension	Thickness	40 Mils	Max
RF Power	Power	4 Watts	Max

[Click here to return to main table.](#)

CLICK HERE TO DOWNLOAD DATA FILES

*Data files contain DXF and S2P files

DIMENSIONS – CASE SIZE D

Bottom View inches (mm)

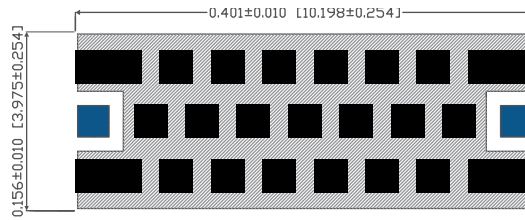

Typical Frequency Response

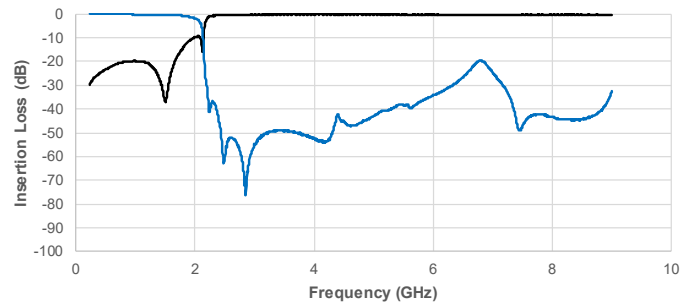

LP0DA1840A7**

ELECTRICAL SPECIFICATIONS

Pass Band	DC - 1.840 GHz	1.2 dB	Max
	DC - 1.840 GHz	0.7 dB	Typ
	3dB Cutoff	2.04 GHz	Typ
Rejection	2.27 - 5.50 GHz	30dB	Min
	2.44 - 4.00 GHz	40dB	Min
Dimension	Thickness	40Mils	Max
RF Power	Power	4 Watts	Max

[Click here to return to main table.](#)

CLICK HERE TO DOWNLOAD DATA FILES

*Data files contain DXF and S2P files

DIMENSIONS – CASE SIZE D

Bottom View inches (mm)

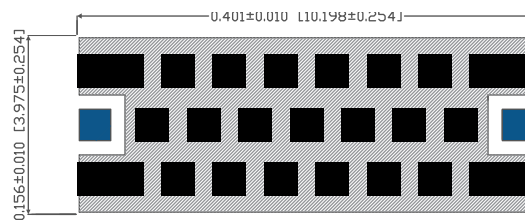

Typical Frequency Response

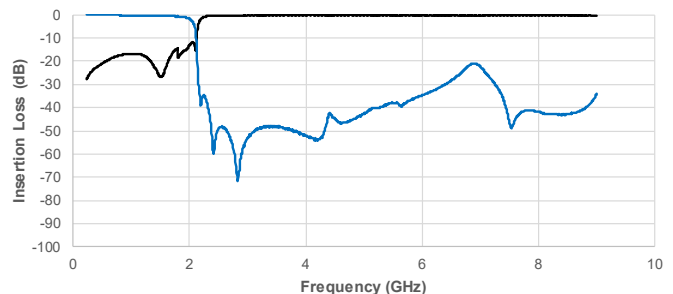

Multilayer Organic (MLO®) Filters

MLO® Low Pass Filters

LP0DA1880A7**

ELECTRICAL SPECIFICATIONS

Pass Band	DC - 1.880 GHz	1.2 dB	Max
	DC - 1.880 GHz	0.8 dB	Typ
	3dB Cutoff	2.05 GHz	Typ
Rejection	2.28 - 6.00 GHz	30dB	Min
	2.42 - 4.00 GHz	40dB	Min
Dimension	Thickness	40 Mils	Max
RF Power	Power	4 Watts	Max

[Click here to return to main table.](#)

CLICK HERE TO DOWNLOAD DATA FILES

*Data files contain DXF and S2P files

DIMENSIONS – CASE SIZE D

Bottom View inches (mm)

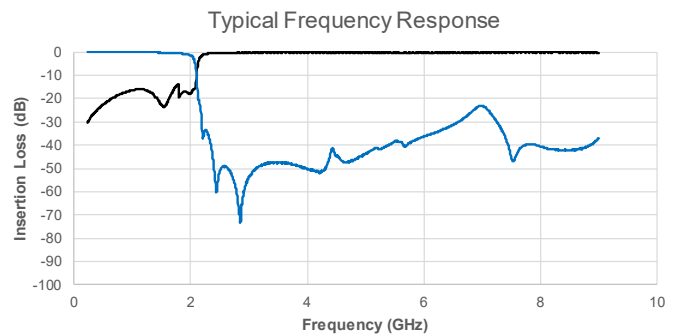
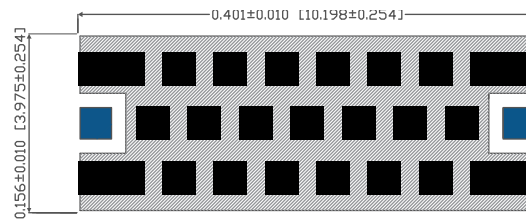

LP0DA1890A7**

ELECTRICAL SPECIFICATIONS

Pass Band	DC - 1.890 GHz	1.2 dB	Max
	DC - 1.890 GHz	0.8 dB	Typ
	3dB Cutoff	2.13 GHz	Typ
Rejection	2.38 - 7.00 GHz	30dB	Min
	- GHz	40dB	Min
Dimension	Thickness	40 Mils	Max
RF Power	Power	4 Watts	Max

[Click here to return to main table.](#)

CLICK HERE TO DOWNLOAD DATA FILES

*Data files contain DXF and S2P files

DIMENSIONS – CASE SIZE D

Bottom View inches (mm)

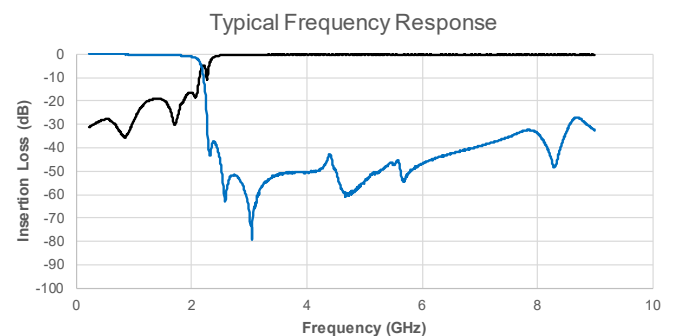
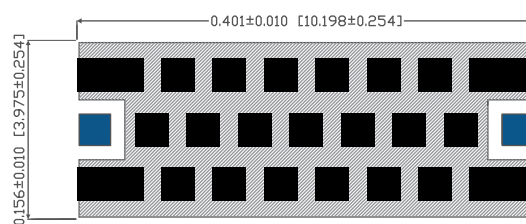

Multilayer Organic (MLO®) Filters

MLO® Low Pass Filters

LP0DA1950A7**

ELECTRICAL SPECIFICATIONS

Pass Band	DC - 1.950 GHz	1.2 dB	Max
	DC - 1.950 GHz	0.8 dB	Typ
	3dB Cutoff	2.20 GHz	Typ
Rejection	2.53 - 8.00 GHz	30dB	Min
	- GHz	40dB	Min
Dimension	Thickness	40 Mils	Max
RF Power	Power	4 Watts	Max

[Click here to return to main table.](#)

CLICK HERE TO DOWNLOAD DATA FILES

*Data files contain DXF and S2P files

DIMENSIONS – CASE SIZE D

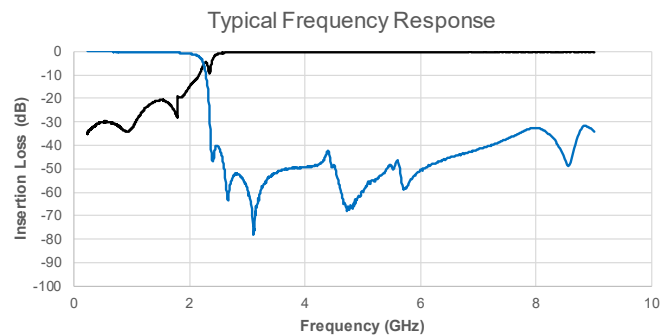
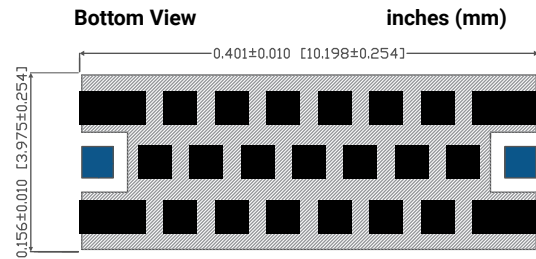

LP0DA2100A7**

ELECTRICAL SPECIFICATIONS

Pass Band	DC - 2.100 GHz	1.2 dB	Max
	DC - 2.100 GHz	0.8 dB	Typ
	3dB Cutoff	2.37 GHz	Typ
Rejection	2.68 - 9.00 GHz	30dB	Min
	2.72 - 5.11 GHz	40dB	Min
Dimension	Thickness	22 Mils	Max
RF Power	Power	4 Watts	Max

[Click here to return to main table.](#)

CLICK HERE TO DOWNLOAD DATA FILES

*Data files contain DXF and S2P files

DIMENSIONS – CASE SIZE D

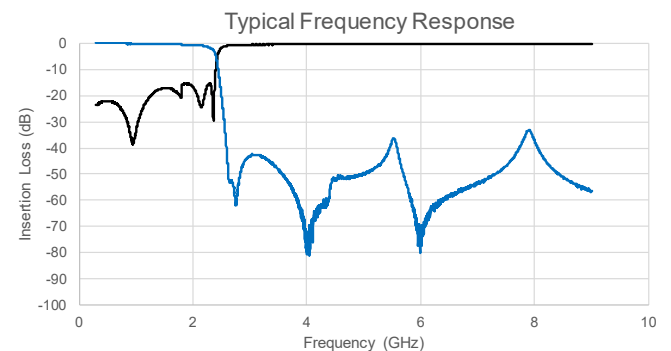
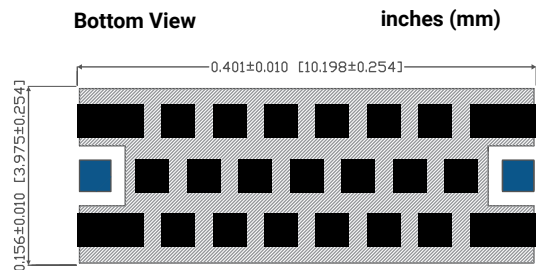

Multilayer Organic (MLO®) Filters

MLO® Low Pass Filters

LP0DA2140A7**

ELECTRICAL SPECIFICATIONS

Pass Band	DC - 2.140 GHz	1.2 dB	Max
	DC - 2.140 GHz	0.7 dB	Typ
	3dB Cutoff	2.38 GHz	Typ
Rejection	2.68 - 9.00 GHz	30dB	Min
	2.72 - 5.23 GHz	40dB	Min
Dimension	Thickness	22 Mils	Max
RF Power	Power	4 Watts	Max

[Click here to return to main table.](#)



CLICK HERE TO DOWNLOAD DATA FILES

*Data files contain DXF and S2P files

DIMENSIONS – CASE SIZE D

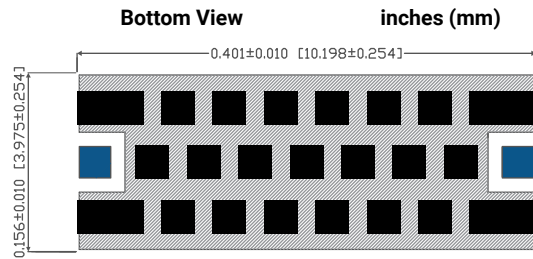

Typical Frequency Response

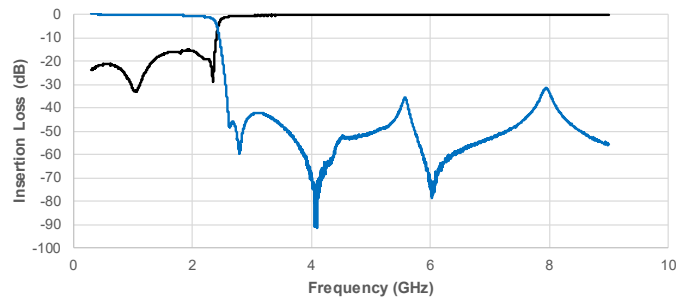

LP0DA2160A7**

ELECTRICAL SPECIFICATIONS

Pass Band	DC - 2.160 GHz	1.2 dB	Max
	DC - 2.160 GHz	0.8 dB	Typ
	3dB Cutoff	2.41 GHz	Typ
Rejection	2.72 - 5.00 GHz	30dB	Min
	- GHz	40dB	Min
Dimension	Thickness	22 Mils	Max
RF Power	Power	4 Watts	Max

[Click here to return to main table.](#)



CLICK HERE TO DOWNLOAD DATA FILES

*Data files contain DXF and S2P files

DIMENSIONS – CASE SIZE D

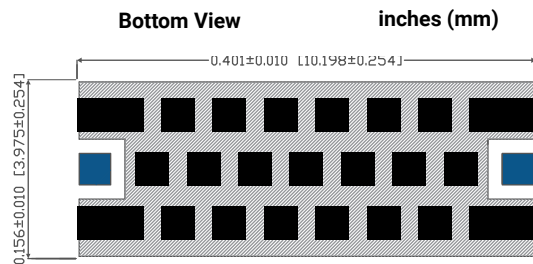

Typical Frequency Response

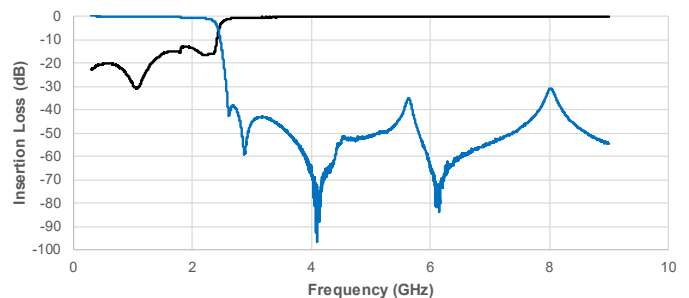

Multilayer Organic (MLO®) Filters

MLO® Low Pass Filters

LP0DA2190A7**

ELECTRICAL SPECIFICATIONS

Pass Band	DC - 2.190 GHz	1.2 dB	Max
	DC - 2.190 GHz	0.6 dB	Typ
	3dB Cutoff	2.44 GHz	Typ
Rejection	2.79 - 6.50 GHz	30dB	Min
	2.93 - 4.00 GHz	40dB	Min
Dimension	Thickness	40 Mils	Max
RF Power	Power	4 Watts	Max

[Click here to return to main table.](#)

CLICK HERE TO DOWNLOAD DATA FILES

*Data files contain DXF and S2P files

DIMENSIONS – CASE SIZE D

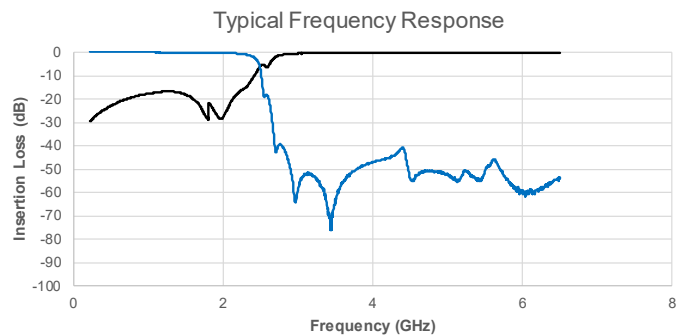
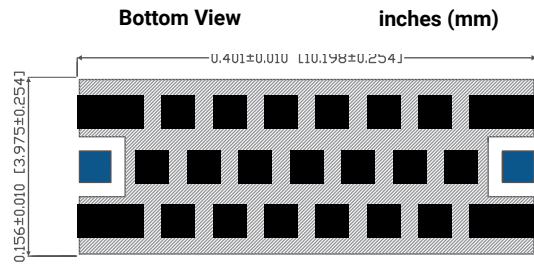

LP0DA2200A7**

ELECTRICAL SPECIFICATIONS

Pass Band	DC - 2.200 GHz	1.2 dB	Max
	DC - 2.200 GHz	0.8 dB	Typ
	3dB Cutoff	2.50 GHz	Typ
Rejection	2.84 - 5.00 GHz	30dB	Min
	4.00 - 5.00 GHz	40dB	Min
Dimension	Thickness	22 Mils	Max
RF Power	Power	4 Watts	Max

[Click here to return to main table.](#)

CLICK HERE TO DOWNLOAD DATA FILES

*Data files contain DXF and S2P files

DIMENSIONS – CASE SIZE D

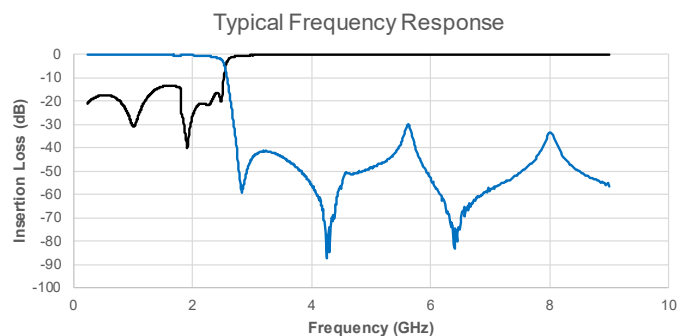
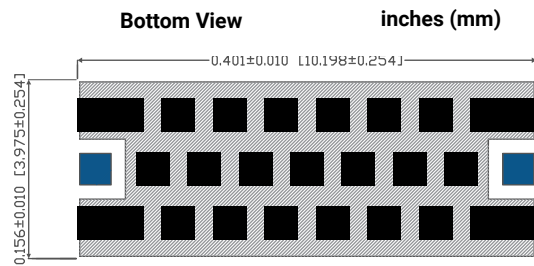

Multilayer Organic (MLO®) Filters

MLO® Low Pass Filters

LP0DA2210A7**

ELECTRICAL SPECIFICATIONS

Pass Band	DC - 2.210 GHz	1.2 dB	Max
	DC - 2.210 GHz	0.8 dB	Typ
	3dB Cutoff	2.60 GHz	Typ
Rejection	2.98 - 8.50 GHz	30dB	Min
	3.25 - 4.25 GHz	40dB	Min
Dimension	Thickness	40 Mils	Max
RF Power	Power	4 Watts	Max

[Click here to return to main table.](#)

CLICK HERE TO DOWNLOAD DATA FILES

*Data files contain DXF and S2P files

DIMENSIONS – CASE SIZE D

Bottom View inches (mm)

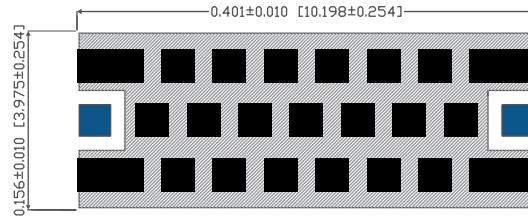

Typical Frequency Response

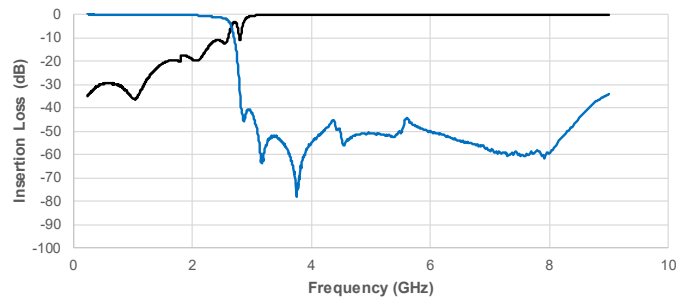

LP0DA2260A7**

ELECTRICAL SPECIFICATIONS

Pass Band	DC - 2.260 GHz	1.2 dB	Max
	DC - 2.260 GHz	0.8 dB	Typ
	3dB Cutoff	2.50 GHz	Typ
Rejection	2.86 - 5.00 GHz	30dB	Min
	4.00 - 5.00 GHz	40dB	Min
Dimension	Thickness	22 Mils	Max
RF Power	Power	4 Watts	Max

[Click here to return to main table.](#)

CLICK HERE TO DOWNLOAD DATA FILES

*Data files contain DXF and S2P files

DIMENSIONS – CASE SIZE D

Bottom View inches (mm)

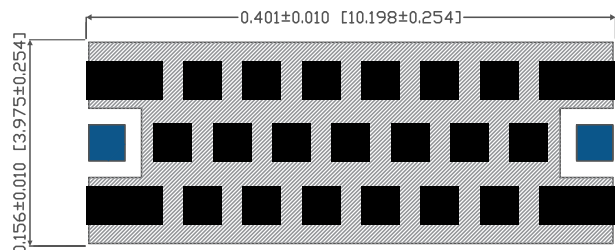

Typical Frequency Response

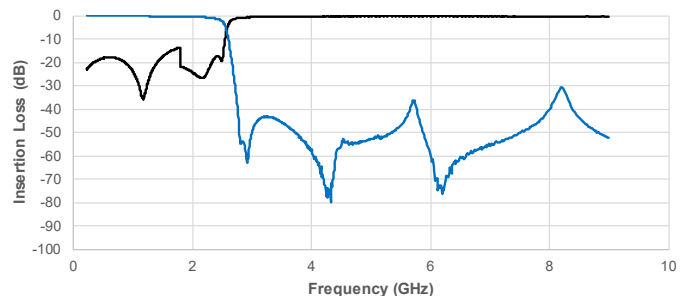

Multilayer Organic (MLO®) Filters

MLO® Low Pass Filters

LP0AA2300A7**

ELECTRICAL SPECIFICATIONS

Pass Band	DC - 2.300 GHz	1.2 dB	Max
	DC - 2.300 GHz	0.9 dB	Typ
	3dB Cutoff	2.56 GHz	Typ
Rejection	3.15 - 9.00 GHz	30dB	Min
	3.26 - 9.00 GHz	40dB	Min
Dimension	Thickness	22 Mils	Max
RF Power	Power	4 Watts	Max

[Click here to return to main table.](#)

CLICK HERE TO DOWNLOAD DATA FILES

*Data files contain DXF and S2P files

DIMENSIONS – CASE SIZE A

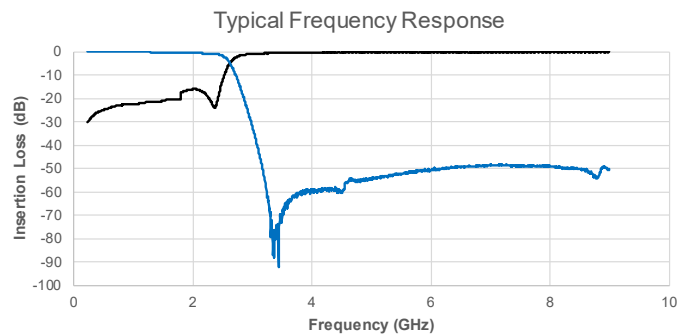
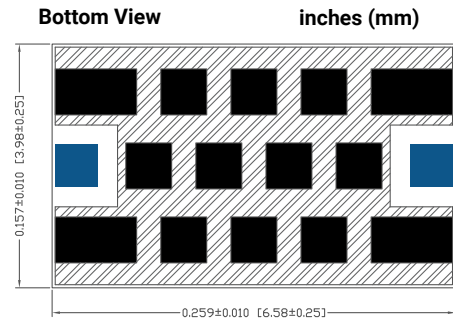

LP0AA2490A7**

ELECTRICAL SPECIFICATIONS

Pass Band	DC - 2.490 GHz	1.2 dB	Max
	DC - 2.490 GHz	0.7 dB	Typ
	3dB Cutoff	2.80 GHz	Typ
Rejection	3.98 - 9.00 GHz	30dB	Min
	3.79 - 5.00 GHz	40dB	Min
Dimension	Thickness	40 Mils	Max
RF Power	Power	4 Watts	Max

[Click here to return to main table.](#)

CLICK HERE TO DOWNLOAD DATA FILES

*Data files contain DXF and S2P files

DIMENSIONS – CASE SIZE A

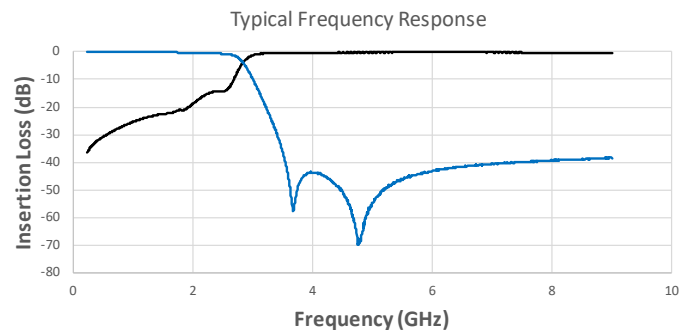
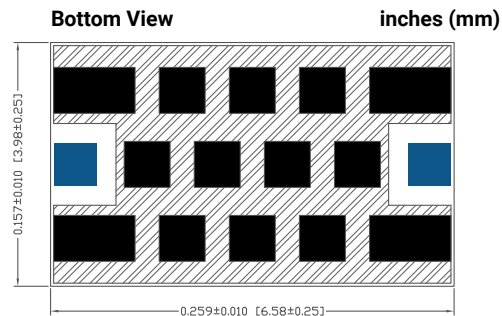

Multilayer Organic (MLO®) Filters

MLO® Low Pass Filters

LP2EA2530A7**

ELECTRICAL SPECIFICATIONS

Pass Band	DC - 2.530 GHz	1.2 dB	Max
	DC - 2.530 GHz	0.7 dB	Typ
	3dB Cutoff	2.87 GHz	Typ
Rejection	3.28 - 9.00 GHz	30dB	Min
	3.32 - 6.50 GHz	40dB	Min
Dimension	Thickness	40 Mils	Max
RF Power	Power	4 Watts	Max

[Click here to return to main table.](#)

CLICK HERE TO DOWNLOAD DATA FILES

*Data files contain DXF and S2P files

DIMENSIONS – CASE SIZE 2E

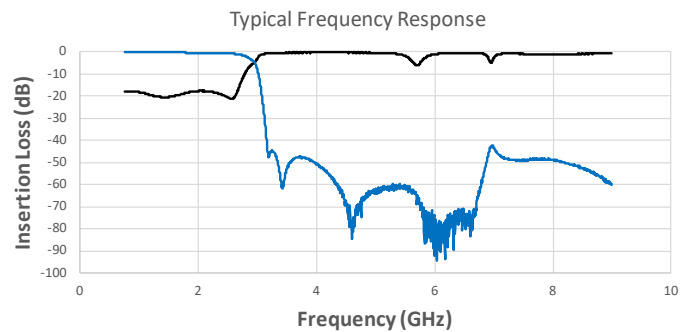
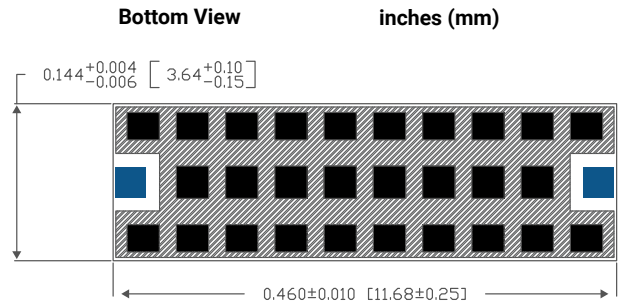

LP0AA2590A7**

ELECTRICAL SPECIFICATIONS

Pass Band	DC - 2.590 GHz	1.2 dB	Max
	DC - 2.590 GHz	0.7 dB	Typ
	3dB Cutoff	2.89 GHz	Typ
Rejection	3.71 - 9.00 GHz	30dB	Min
	3.87 - 5.20 GHz	40dB	Min
Dimension	Thickness	40 Mils	Max
RF Power	Power	4 Watts	Max

[Click here to return to main table.](#)

CLICK HERE TO DOWNLOAD DATA FILES

*Data files contain DXF and S2P files

DIMENSIONS – CASE SIZE A

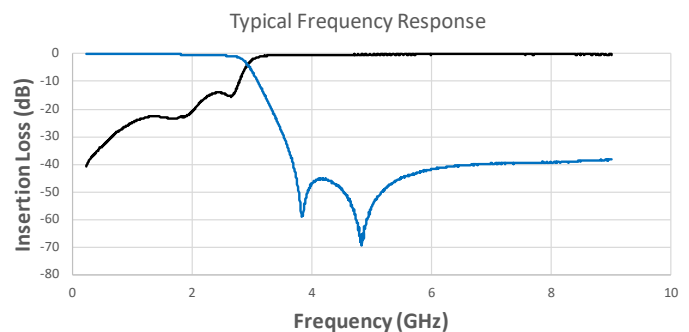
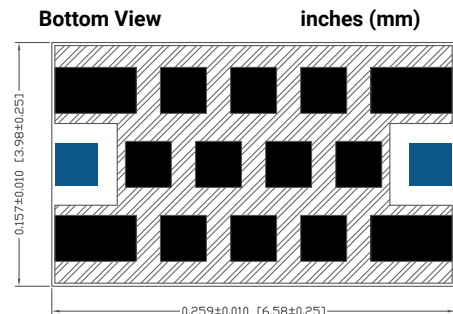

Multilayer Organic (MLO®) Filters

MLO® Low Pass Filters

LP2EA2600A7**

ELECTRICAL SPECIFICATIONS

Pass Band	DC - 2.600 GHz	1.2 dB	Max
	DC - 2.600 GHz	0.7 dB	Typ
	3dB Cutoff	2.95 GHz	Typ
Rejection	3.40 - 9.00 GHz	30dB	Min
	3.50 - 6.00 GHz	40dB	Min
Dimension	Thickness	40 Mils	Max
RF Power	Power	4 Watts	Max

[Click here to return to main table.](#)

CLICK HERE TO DOWNLOAD DATA FILES

*Data files contain DXF and S2P files

DIMENSIONS – CASE SIZE 2E

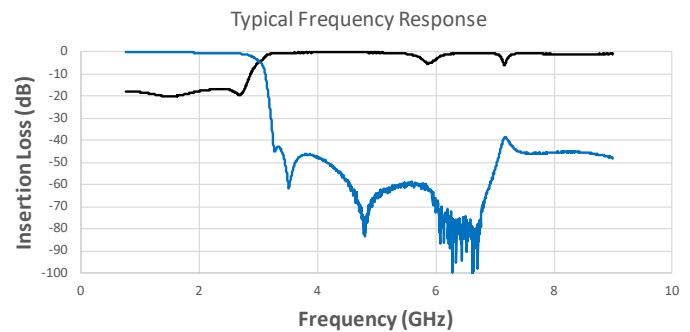
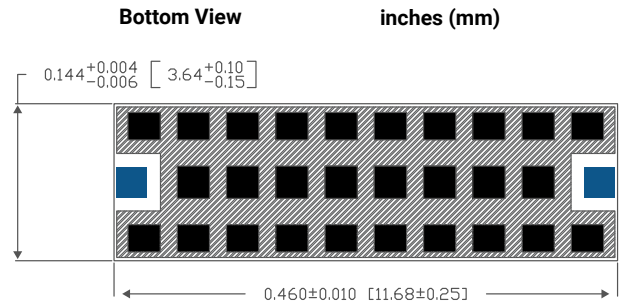

LP0AA2640A7**

ELECTRICAL SPECIFICATIONS

Pass Band	DC - 2.640 GHz	1.2 dB	Max
	DC - 2.640 GHz	0.8 dB	Typ
	3dB Cutoff	2.97 GHz	Typ
Rejection	3.82 - 9.00 GHz	30dB	Min
	3.98 - 5.50 GHz	40dB	Min
Dimension	Thickness	40 Mils	Max
RF Power	Power	4 Watts	Max

[Click here to return to main table.](#)

CLICK HERE TO DOWNLOAD DATA FILES

*Data files contain DXF and S2P files

DIMENSIONS – CASE SIZE A

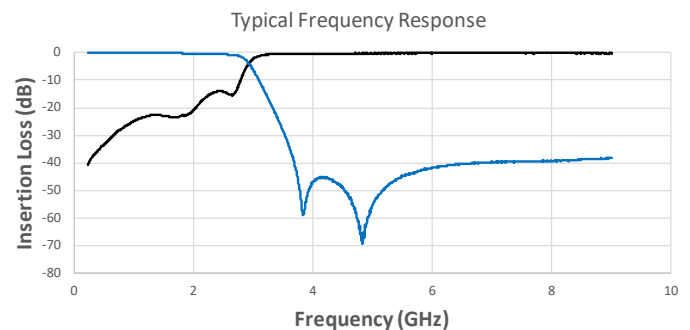
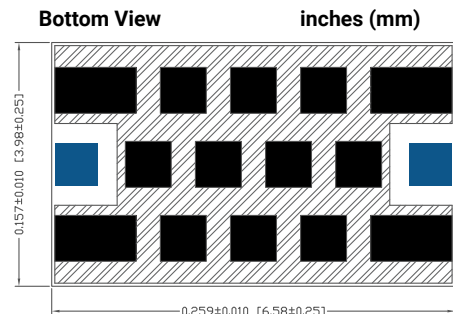

Multilayer Organic (MLO®) Filters

MLO® Low Pass Filters

LP0AA2910A7**

ELECTRICAL SPECIFICATIONS

Pass Band	DC - 2.910 GHz	1.2 dB	Max
	DC - 2.910 GHz	0.8 dB	Typ
	3dB Cutoff	3.43 GHz	Typ
Rejection	4.07 - 9.00 GHz	30dB	Min
	4.80 - 8.00 GHz	40dB	Min
Dimension	Thickness	22 Mils	Max
RF Power	Power	4 Watts	Max

[Click here to return to main table.](#)

CLICK HERE TO DOWNLOAD DATA FILES

*Data files contain DXF and S2P files

DIMENSIONS – CASE SIZE A

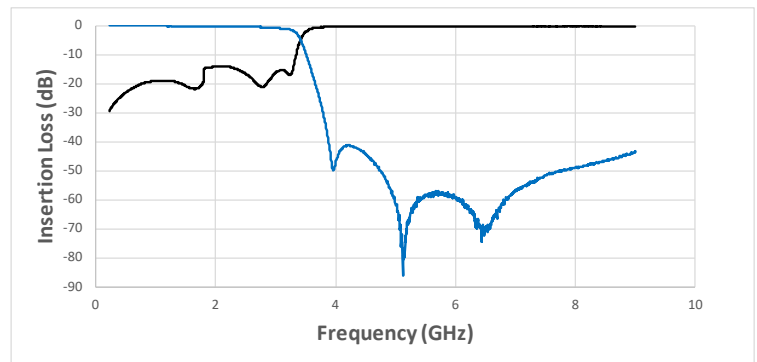
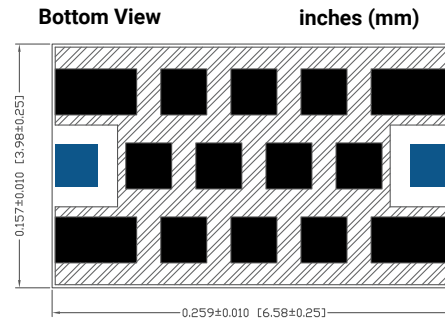

LP0AA2980A7**

ELECTRICAL SPECIFICATIONS

Pass Band	DC - 2.980 GHz	1.2 dB	Max
	DC - 2.980 GHz	0.7 dB	Typ
	3dB Cutoff	3.52 GHz	Typ
Rejection	4.17 - 9.00 GHz	30dB	Min
	4.29 - 8.00 GHz	40dB	Min
Dimension	Thickness	22 Mils	Max
RF Power	Power	4 Watts	Max

[Click here to return to main table.](#)

CLICK HERE TO DOWNLOAD DATA FILES

*Data files contain DXF and S2P files

DIMENSIONS – CASE SIZE A

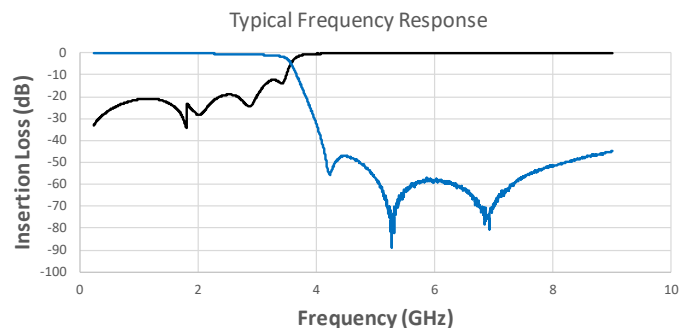
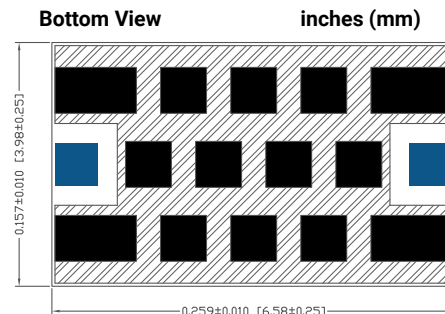

Multilayer Organic (MLO®) Filters

MLO® Low Pass Filters

LP0AA3100A7**

ELECTRICAL SPECIFICATIONS

Pass Band	DC - 3.100 GHz	1.2 dB	Max
	DC - 3.100 GHz	0.7 dB	Typ
	3dB Cutoff	3.65 GHz	Typ
Rejection	4.32 - 9.00 GHz	30dB	Min
	5.00 - 8.00 GHz	40dB	Min
Dimension	Thickness	22 Mils	Max
RF Power	Power	4 Watts	Max

[Click here to return to main table.](#)



CLICK HERE TO DOWNLOAD DATA FILES

*Data files contain DXF and S2P files

DIMENSIONS – CASE SIZE A

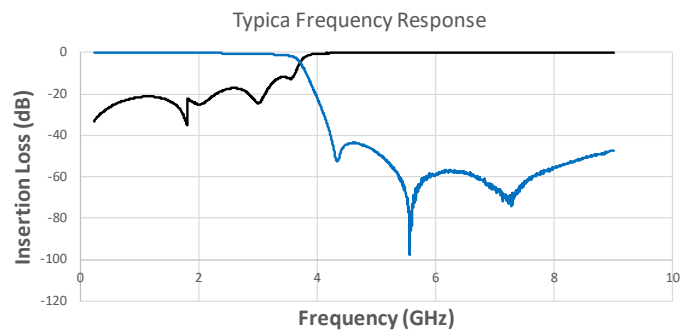
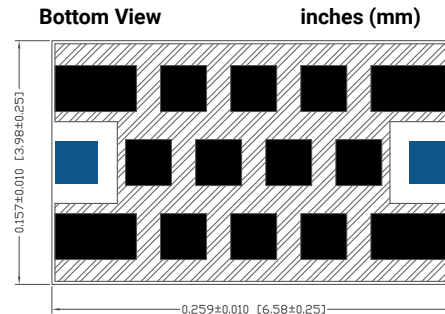

LP0AA3160A7**

ELECTRICAL SPECIFICATIONS

Pass Band	DC - 3.160 GHz	1.2 dB	Max
	DC - 3.160 GHz	0.8 dB	Typ
	3dB Cutoff	3.47 GHz	Typ
Rejection	4.36 - 9.00 GHz	30dB	Min
	4.47 - 9.00 GHz	40dB	Min
Dimension	Thickness	22 Mils	Max
RF Power	Power	4 Watts	Max

[Click here to return to main table.](#)



CLICK HERE TO DOWNLOAD DATA FILES

*Data files contain DXF and S2P files

DIMENSIONS – CASE SIZE A

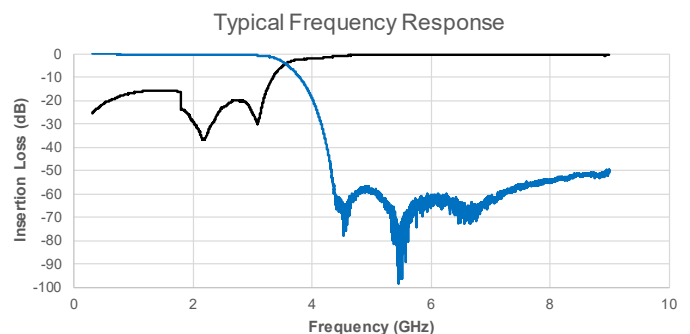
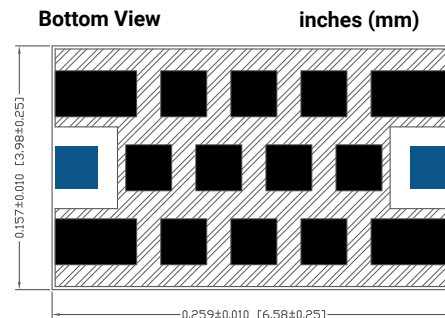

Multilayer Organic (MLO®) Filters

MLO® Low Pass Filters

LP0AA4080A7**

ELECTRICAL SPECIFICATIONS

Pass Band	DC - 4.080 GHz	1.2 dB	Max
	DC - 4.080 GHz	0.7 dB	Typ
	3dB Cutoff	5.03 GHz	Typ
Rejection	5.62 - 9.00 GHz	30dB	Min
	5.69 - 9.00 GHz	40dB	Min
Dimension	Thickness	22 Mils	Max
RF Power	Power	4 Watts	Max

[Click here to return to main table.](#)

CLICK HERE TO DOWNLOAD DATA FILES

*Data files contain DXF and S2P files

DIMENSIONS – CASE SIZE A

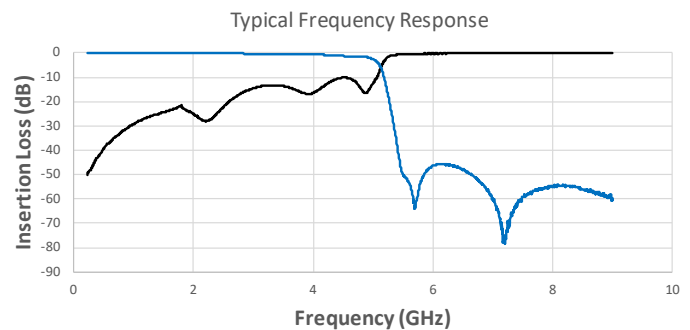
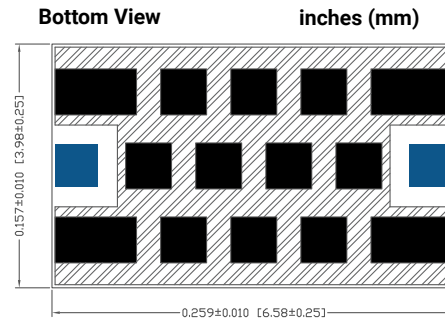

LP0AA4150A7**

ELECTRICAL SPECIFICATIONS

Pass Band	DC - 4.150 GHz	1.2 dB	Max
	DC - 4.150 GHz	0.6 dB	Typ
	3dB Cutoff	5.16 GHz	Typ
Rejection	5.75 - 9.00 GHz	30dB	Min
	5.82 - 9.00 GHz	40dB	Min
Dimension	Thickness	22 Mils	Max
RF Power	Power	4 Watts	Max

[Click here to return to main table.](#)

CLICK HERE TO DOWNLOAD DATA FILES

*Data files contain DXF and S2P files

DIMENSIONS – CASE SIZE A

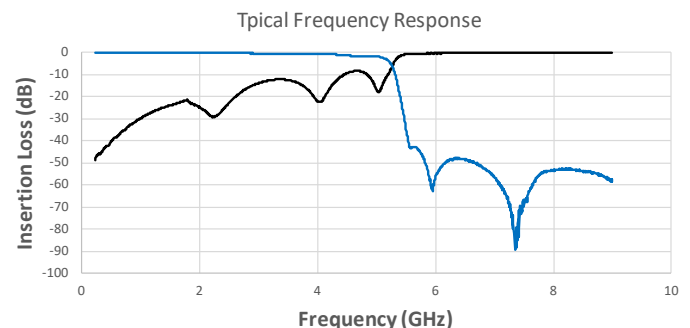
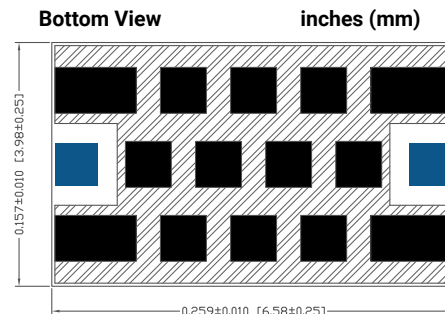

Multilayer Organic (MLO®) Filters

MLO® Low Pass Filters

LP0AA4210A7**

ELECTRICAL SPECIFICATIONS

Pass Band	DC - 4.210 GHz	1.2 dB	Max
	DC - 4.210 GHz	0.7 dB	Typ
	3dB Cutoff	5.28 GHz	Typ
Rejection	5.87 - 9.00 GHz	30dB	Min
	6.16 - 9.00 GHz	40dB	Min
Dimension	Thickness	22 Mils	Max
	RF Power	Power	4 Watts
			Max

[Click here to return to main table.](#)

CLICK HERE TO DOWNLOAD DATA FILES

*Data files contain DXF and S2P files

DIMENSIONS – CASE SIZE A

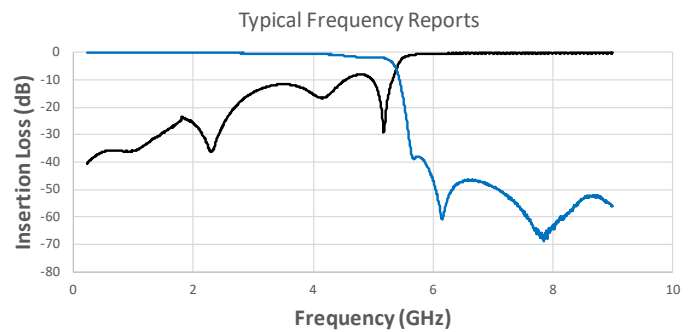
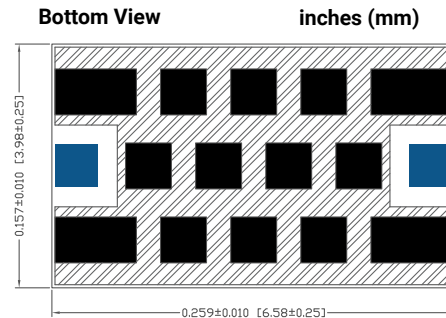

LP0AA4370A7**

ELECTRICAL SPECIFICATIONS

Pass Band	DC - 4.370 GHz	1.2 dB	Max
	DC - 7.370 GHz	0.8 dB	Typ
	3dB Cutoff	4.84 GHz	Typ
Rejection	6.00 - 9.00 GHz	30dB	Min
	6.32 - 9.00 GHz	40dB	Min
Dimension	Thickness	22 Mils	Max
	RF Power	Power	4 Watts
			Max

[Click here to return to main table.](#)

CLICK HERE TO DOWNLOAD DATA FILES

*Data files contain DXF and S2P files

DIMENSIONS – CASE SIZE A

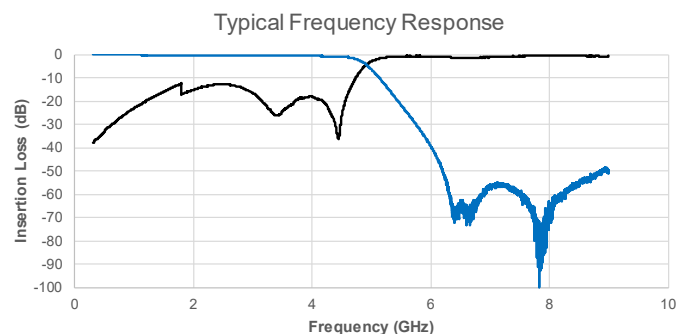
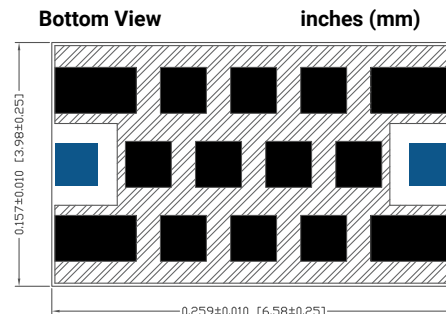

Multilayer Organic (MLO®) Filters

MLO® Low Pass Filters

LP0AA6160A7**

ELECTRICAL SPECIFICATIONS

Pass Band	DC - 6.160 GHz	1.2 dB	Max
	DC - 6.160 GHz	0.9 dB	Typ
	3dB Cutoff	7.09 GHz	Typ
Rejection	8.59 - 13.00 GHz	30dB	Min
	8.82 - 11.50 GHz	40dB	Min
Dimension	Thickness	22 Mils	Max
RF Power	Power	4 Watts	Max

[Click here to return to main table.](#)



CLICK HERE TO DOWNLOAD DATA FILES

*Data files contain DXF and S2P files

DIMENSIONS – CASE SIZE A

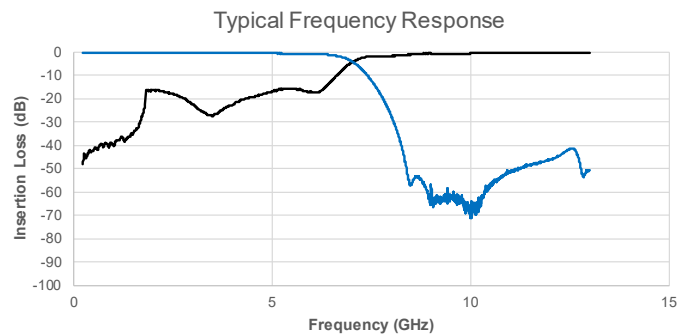
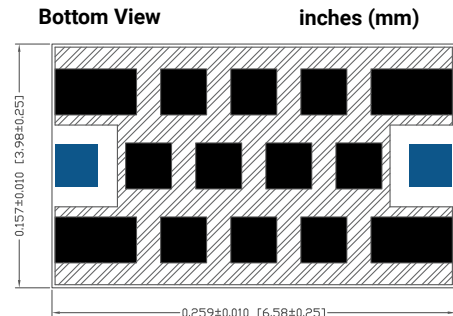

LP0FA0054A7**

ELECTRICAL SPECIFICATIONS

Pass Band	DC - 0.054 GHz	1.2 dB	Max
	DC - 0.054 GHz	0.9 dB	Typ
	-3dB Cutoff	0.071 GHz	Typ
Rejection	0.083 - 0.7 GHz	30 dB	Min
	N/A	40 dB	Min
Dimension	Thickness	40 Mils	Max
RF Power	Power	4 Watts	Max

[Click here to return to main table.](#)



CLICK HERE TO DOWNLOAD DATA FILES

*Data files contain DXF and S2P files

DIMENSIONS – CASE SIZE F

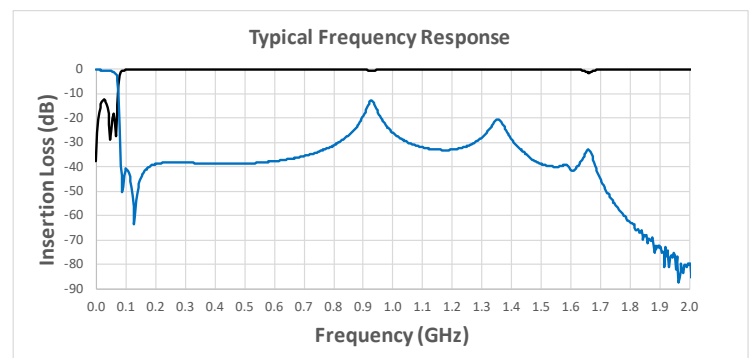
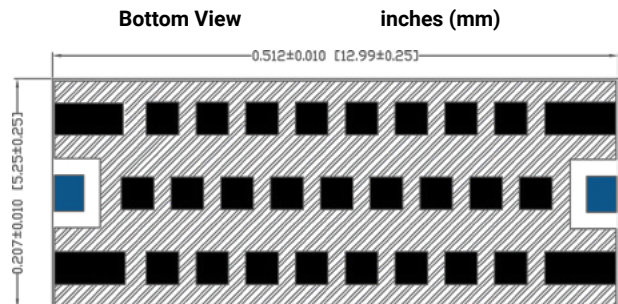

Multilayer Organic (MLO®) Filters

MLO® Low Pass Filters

LP0FA0056A7**

ELECTRICAL SPECIFICATIONS

Pass Band	DC - 0.057 GHz	1.2 dB	Max
	DC - 0.057 GHz	0.9 dB	Typ
	-3dB Cutoff	0.072 GHz	Typ
Rejection	0.089 - 0.7 GHz	30 dB	Min
	N/A	40 dB	Min
Dimension	Thickness	40 Mils	Max
RF Power	Power	4 Watts	Max

[Click here to return to main table.](#)

CLICK HERE TO DOWNLOAD DATA FILES

*Data files contain DXF and S2P files

DIMENSIONS – CASE SIZE F

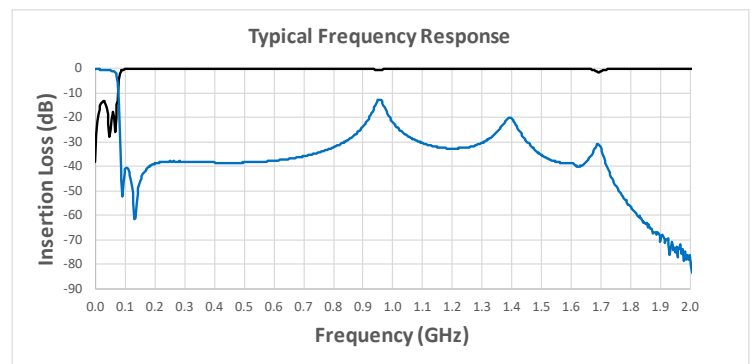
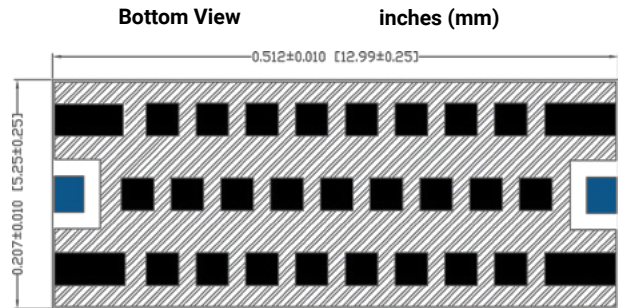

LP0FA0057A7**

ELECTRICAL SPECIFICATIONS

Pass Band	DC - 0.057 GHz	1.2 dB	Max
	DC - 0.057 GHz	0.9 dB	Typ
	-3dB Cutoff	0.073 GHz	Typ
Rejection	0.09 - 0.7 GHz	30 dB	Min
	N/A	40 dB	Min
Dimension	Thickness	40 Mils	Max
RF Power	Power	4 Watts	Max

[Click here to return to main table.](#)

CLICK HERE TO DOWNLOAD DATA FILES

*Data files contain DXF and S2P files

DIMENSIONS – CASE SIZE F

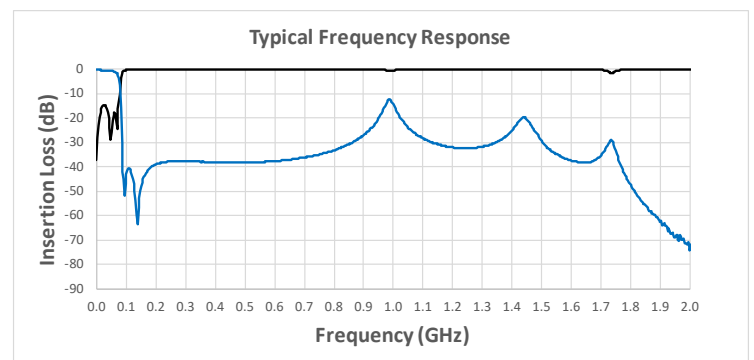
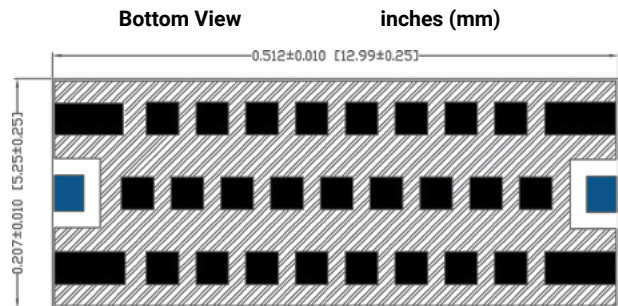

Multilayer Organic (MLO®) Filters

MLO® Low Pass Filters

LP0EA0076A7**

ELECTRICAL SPECIFICATIONS

Pass Band	DC - 0.076 GHz	1.2 dB	Max
	DC - 0.076 GHz	0.9 dB	Typ
	-3dB Cutoff	0.096 GHz	Typ
Rejection	0.115 - 0.8 GHz	30 dB	Min
	N/A	40 dB	Min
Dimension	Thickness	40 Mils	Max
RF Power	Power	4 Watts	Max

[Click here to return to main table.](#)



CLICK HERE TO DOWNLOAD DATA FILES

*Data files contain DXF and S2P files

DIMENSIONS – CASE SIZE E

Bottom View

inches (mm)

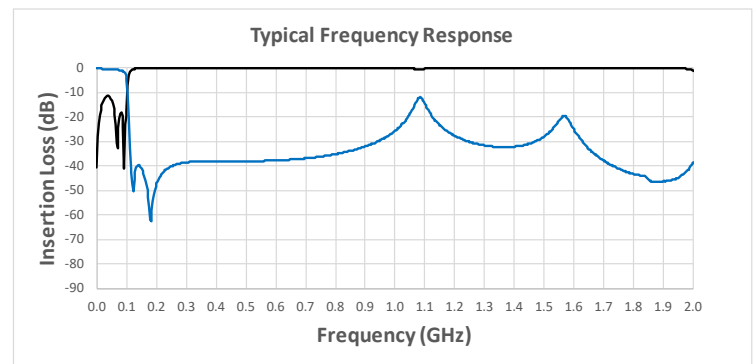
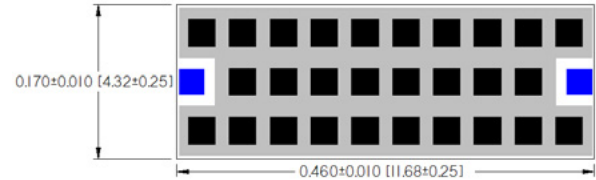

LP0EA0080A7**

ELECTRICAL SPECIFICATIONS

Pass Band	DC - 0.08 GHz	1.2 dB	Max
	DC - 0.08 GHz	0.9 dB	Typ
	-3dB Cutoff	0.102 GHz	Typ
Rejection	0.121 - 0.8 GHz	30 dB	Min
	N/A	40 dB	Min
Dimension	Thickness	40 Mils	Max
RF Power	Power	4 Watts	Max

[Click here to return to main table.](#)



CLICK HERE TO DOWNLOAD DATA FILES

*Data files contain DXF and S2P files

DIMENSIONS – CASE SIZE E

Bottom View

inches (mm)

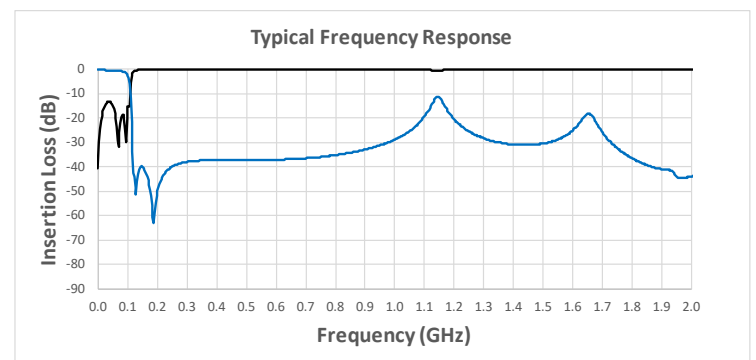
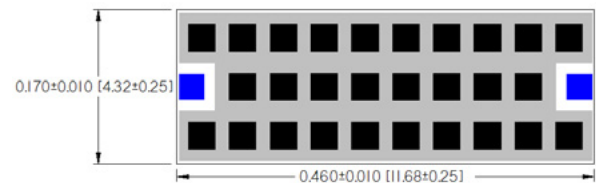

Multilayer Organic (MLO®) Filters

MLO® Low Pass Filters

LP0EA0082A7**

ELECTRICAL SPECIFICATIONS

Pass Band	DC - 0.082 GHz	1.2 dB	Max
	DC - 0.082 GHz	0.8 dB	Typ
	-3dB Cutoff	0.105 GHz	Typ
Rejection	0.125 - 0.8 GHz	30 dB	Min
	N/A	40 dB	Min
Dimension	Thickness	40 Mils	Max
RF Power	Power	4 Watts	Max

[Click here to return to main table.](#)

CLICK HERE TO DOWNLOAD DATA FILES

*Data files contain DXF and S2P files

DIMENSIONS – CASE SIZE E

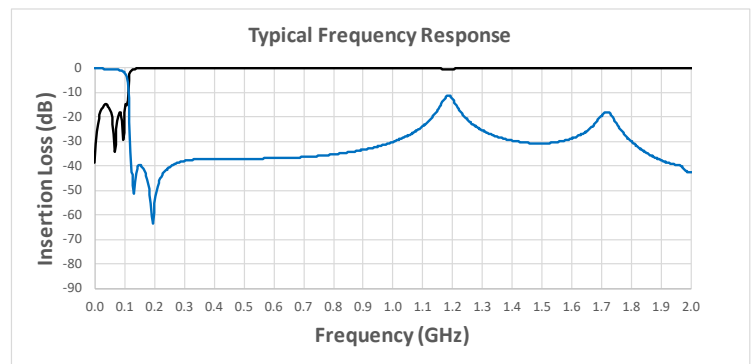
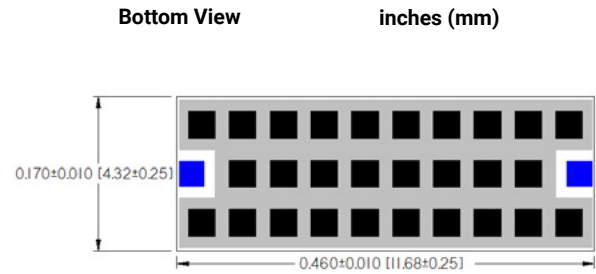

LP0DA0102A7**

ELECTRICAL SPECIFICATIONS

Pass Band	DC - 0.102 GHz	1.2 dB	Max
	DC - 0.102 GHz	0.9 dB	Typ
	-3dB Cutoff	0.132 GHz	Typ
Rejection	0.155 - 0.9 GHz	30 dB	Min
	N/A	40 dB	Min
Dimension	Thickness	40 Mils	Max
RF Power	Power	4 Watts	Max

[Click here to return to main table.](#)

CLICK HERE TO DOWNLOAD DATA FILES

*Data files contain DXF and S2P files

DIMENSIONS – CASE SIZE D

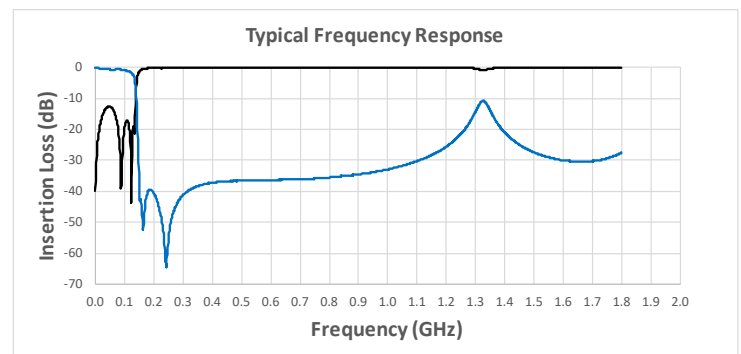
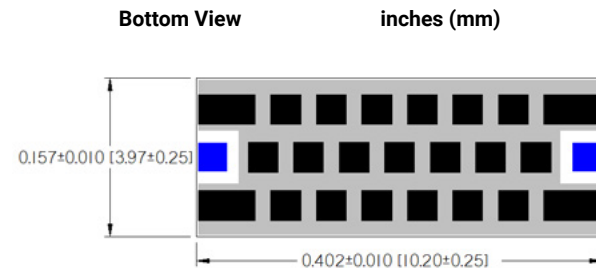

Multilayer Organic (MLO®) Filters

MLO® Low Pass Filters

LP0DA0107A7**

ELECTRICAL SPECIFICATIONS

Pass Band	DC - 0.107 GHz	1.2 dB	Max
	DC - 0.107 GHz	0.9 dB	Typ
	-3dB Cutoff	0.136 GHz	Typ
Rejection	0.16 - 0.9 GHz	30 dB	Min
	N/A	40 dB	Min
Dimension	Thickness	40 Mils	Max
RF Power	Power	4 Watts	Max

[Click here to return to main table.](#)



CLICK HERE TO DOWNLOAD DATA FILES

*Data files contain DXF and S2P files

DIMENSIONS – CASE SIZE D

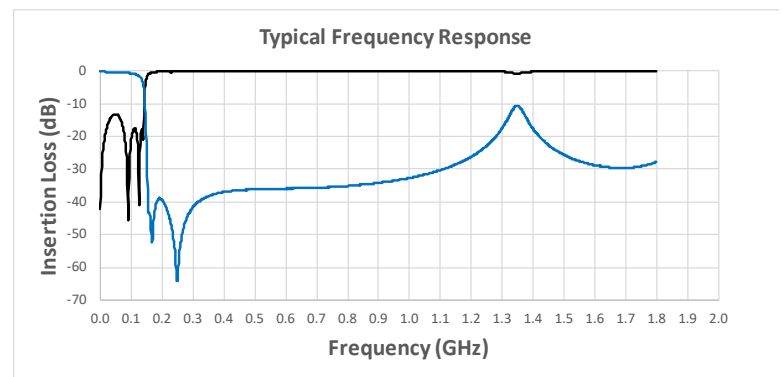
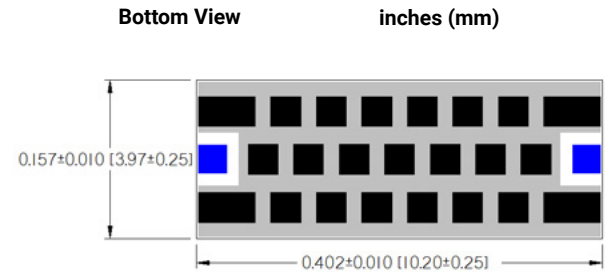

LP0DA0112A7**

ELECTRICAL SPECIFICATIONS

Pass Band	DC - 0.112 GHz	1.2 dB	Max
	DC - 0.112 GHz	0.9 dB	Typ
	-3dB Cutoff	0.143 GHz	Typ
Rejection	0.167 - 0.9 GHz	30 dB	Min
	N/A	40 dB	Min
Dimension	Thickness	40 Mils	Max
RF Power	Power	4 Watts	Max

[Click here to return to main table.](#)



CLICK HERE TO DOWNLOAD DATA FILES

*Data files contain DXF and S2P files

DIMENSIONS – CASE SIZE D

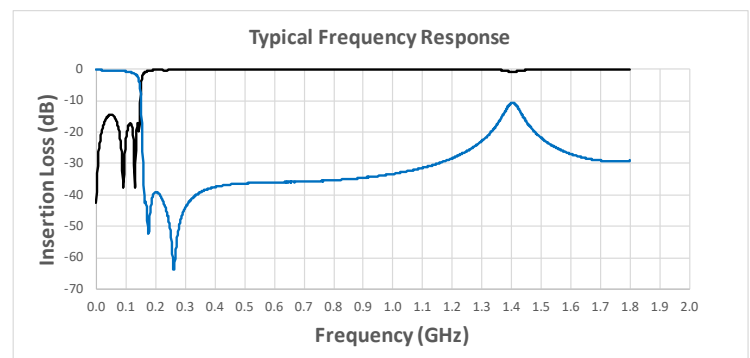
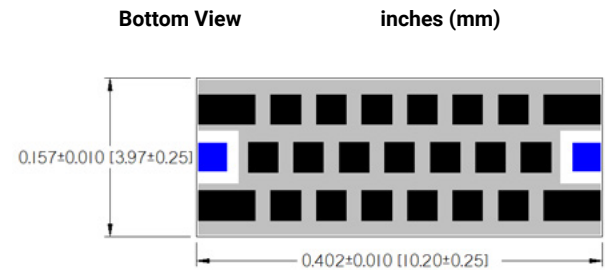

Multilayer Organic (MLO®) Filters

MLO® Low Pass Filters

LP0AA0141A7**

ELECTRICAL SPECIFICATIONS

Pass Band	DC - 0.141 GHz	1.2 dB	Max
	DC - 0.141 GHz	0.8 dB	Typ
	-3dB Cutoff	0.172 GHz	Typ
Rejection	0.212 - 2 GHz	30 dB	Min
	N/A	40 dB	Min
Dimension	Thickness	40 Mils	Max
RF Power	Power	4 Watts	Max

[Click here to return to main table.](#)



CLICK HERE TO DOWNLOAD DATA FILES

*Data files contain DXF and S2P files

DIMENSIONS – CASE SIZE A

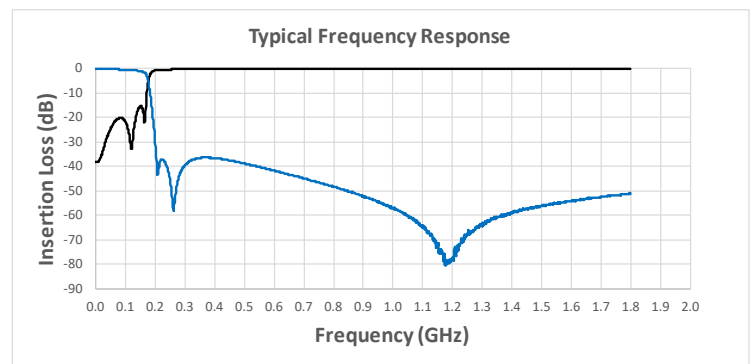
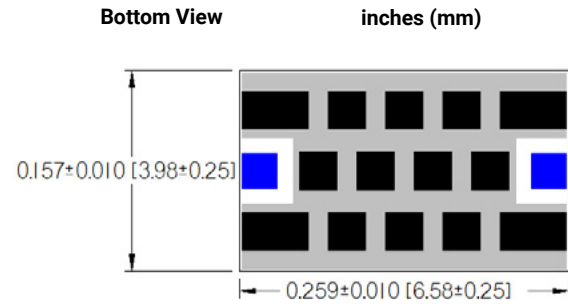

LP0AA0145A7**

ELECTRICAL SPECIFICATIONS

Pass Band	DC - 0.145 GHz	1.2 dB	Max
	DC - 0.145 GHz	0.9 dB	Typ
	-3dB Cutoff	0.174 GHz	Typ
Rejection	0.224 - 2 GHz	30 dB	Min
	N/A	40 dB	Min
Dimension	Thickness	40 Mils	Max
RF Power	Power	4 Watts	Max

[Click here to return to main table.](#)



CLICK HERE TO DOWNLOAD DATA FILES

*Data files contain DXF and S2P files

DIMENSIONS – CASE SIZE A

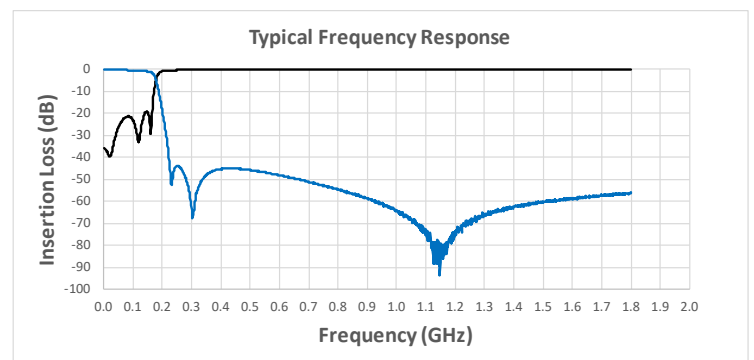
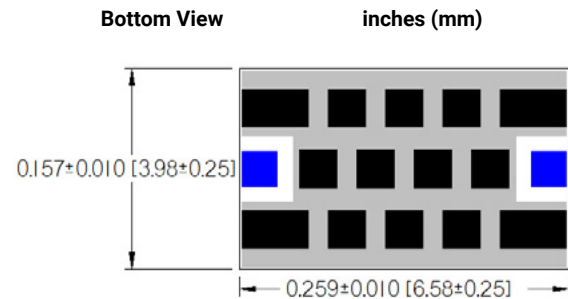

Multilayer Organic (MLO®) Filters

MLO® Low Pass Filters

LP0AA0149A7**

ELECTRICAL SPECIFICATIONS

Pass Band	DC - 0.149 GHz	1.2 dB	Max
	DC - 0.149 GHz	0.8 dB	Typ
	-3dB Cutoff	0.182 GHz	Typ
Rejection	0.224 - 2 GHz	30 dB	Min
	N/A	40 dB	Min
Dimension	Thickness	40 Mils	Max
RF Power	Power	4 Watts	Max

[Click here to return to main table.](#)



CLICK HERE TO DOWNLOAD DATA FILES

*Data files contain DXF and S2P files

DIMENSIONS – CASE SIZE A

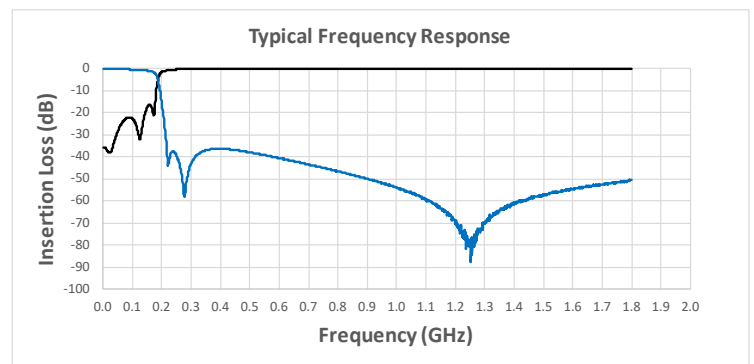
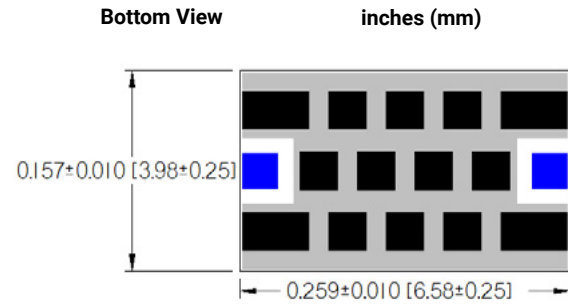

LP0AA0153A7**

ELECTRICAL SPECIFICATIONS

Pass Band	DC - 0.153 GHz	1.2 dB	Max
	DC - 0.153 GHz	0.8 dB	Typ
	-3dB Cutoff	0.189 GHz	Typ
Rejection	0.231 - 2 GHz	30 dB	Min
	N/A	40 dB	Min
Dimension	Thickness	40 Mils	Max
RF Power	Power	4 Watts	Max

[Click here to return to main table.](#)



CLICK HERE TO DOWNLOAD DATA FILES

*Data files contain DXF and S2P files

DIMENSIONS – CASE SIZE A

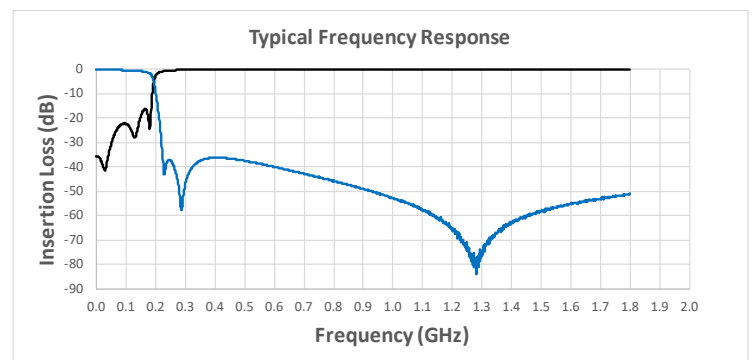
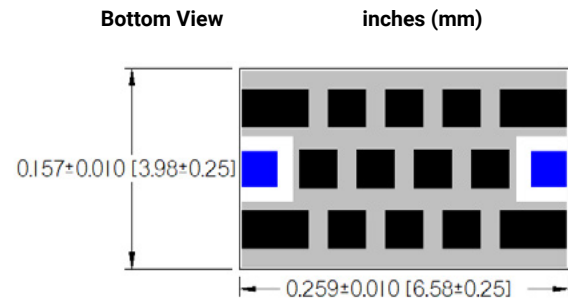

Multilayer Organic (MLO®) Filters

MLO® Low Pass Filters

LP0AA0156A7**

ELECTRICAL SPECIFICATIONS

Pass Band	DC - 0.156 GHz	1.2 dB	Max
	DC - 0.156 GHz	0.8 dB	Typ
	-3dB Cutoff	0.192 GHz	Typ
Rejection	0.236 - 2 GHz	30 dB	Min
	N/A	40 dB	Min
Dimension	Thickness	40 Mils	Max
RF Power	Power	4 Watts	Max

[Click here to return to main table.](#)

CLICK HERE TO DOWNLOAD DATA FILES

*Data files contain DXF and S2P files

DIMENSIONS – CASE SIZE A

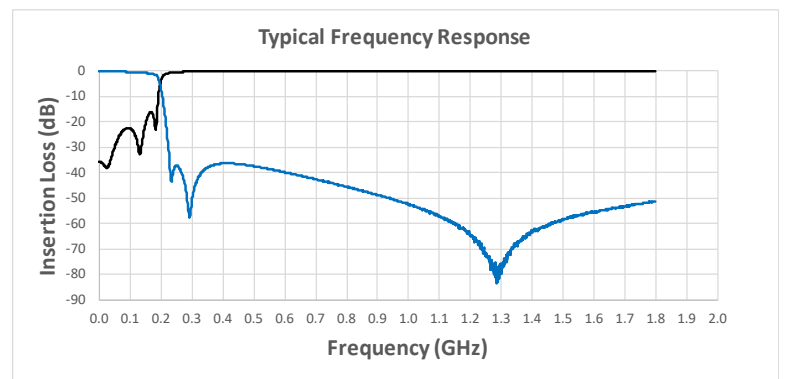
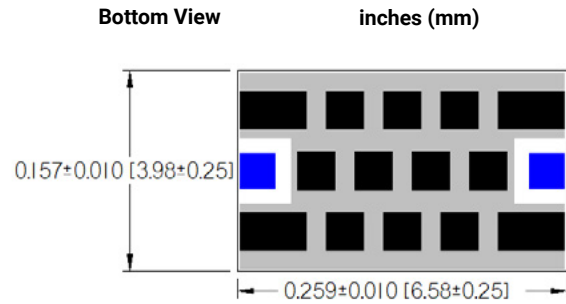

LP0AA0161A7**

ELECTRICAL SPECIFICATIONS

Pass Band	DC - 0.161 GHz	1.2 dB	Max
	DC - 0.161 GHz	0.8 dB	Typ
	-3dB Cutoff	0.197 GHz	Typ
Rejection	0.241 - 2 GHz	30 dB	Min
	N/A	40 dB	Min
Dimension	Thickness	40 Mils	Max
RF Power	Power	4 Watts	Max

[Click here to return to main table.](#)

CLICK HERE TO DOWNLOAD DATA FILES

*Data files contain DXF and S2P files

DIMENSIONS – CASE SIZE A

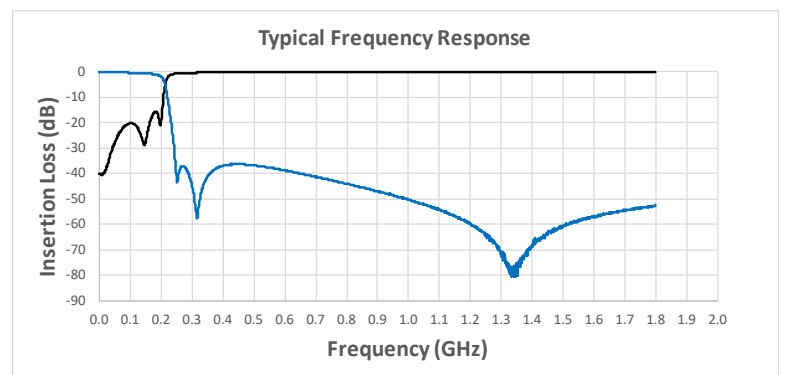
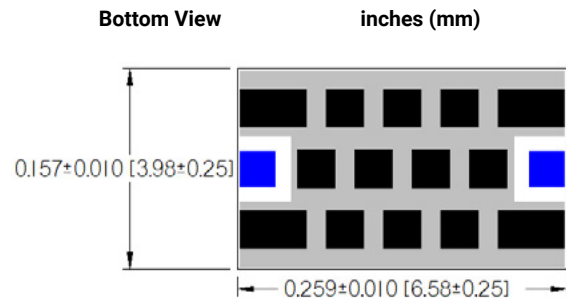

Multilayer Organic (MLO®) Filters

MLO® Low Pass Filters

LP0AA0171A7**

ELECTRICAL SPECIFICATIONS

Pass Band	DC - 0.171 GHz	1.2 dB	Max
	DC - 0.171 GHz	0.8 dB	Typ
	-3dB Cutoff	0.207 GHz	Typ
Rejection	0.255 - 2 GHz	30 dB	Min
	N/A	40 dB	Min
Dimension	Thickness	40 Mils	Max
RF Power	Power	4 Watts	Max

[Click here to return to main table.](#)



CLICK HERE TO DOWNLOAD DATA FILES

*Data files contain DXF and S2P files

DIMENSIONS – CASE SIZE A

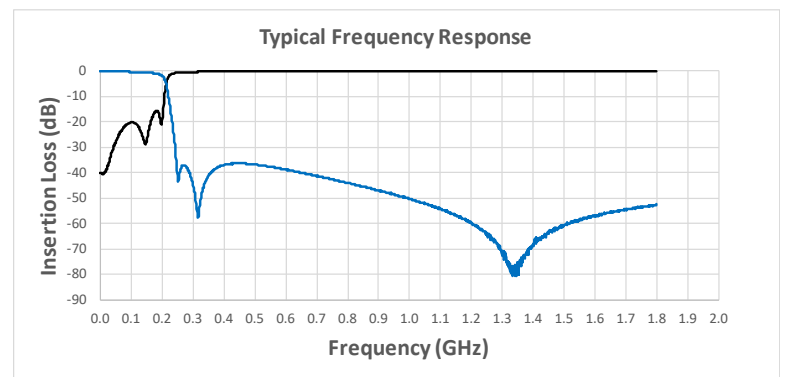
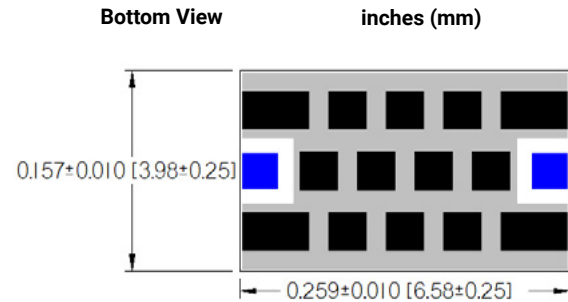

LP0AA0174A7**

ELECTRICAL SPECIFICATIONS

Pass Band	DC - 0.174 GHz	1.2 dB	Max
	DC - 0.174 GHz	0.8 dB	Typ
	-3dB Cutoff	0.212 GHz	Typ
Rejection	0.26 - 2 GHz	30 dB	Min
	N/A	40 dB	Min
Dimension	Thickness	40 Mils	Max
RF Power	Power	4 Watts	Max

[Click here to return to main table.](#)



CLICK HERE TO DOWNLOAD DATA FILES

*Data files contain DXF and S2P files

DIMENSIONS – CASE SIZE A

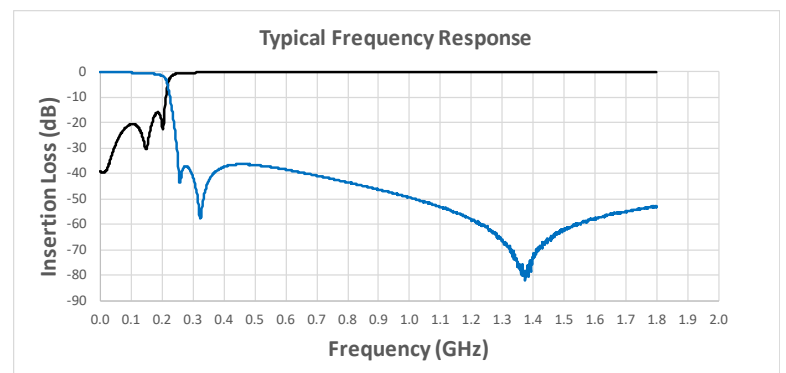
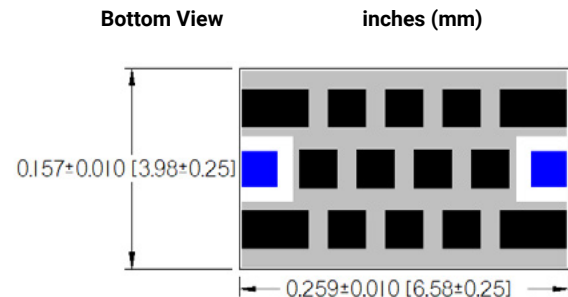

Multilayer Organic (MLO®) Filters

MLO® Low Pass Filters

LP0AA0185A7**

ELECTRICAL SPECIFICATIONS

Pass Band	DC - 0.185 GHz	1.2 dB	Max
	DC - 0.185 GHz	0.8 dB	Typ
	-3dB Cutoff	0.22 GHz	Typ
Rejection	0.27 - 2 GHz	30 dB	Min
	N/A	40 dB	Min
Dimension	Thickness	40 Mils	Max
RF Power	Power	4 Watts	Max

[Click here to return to main table.](#)

CLICK HERE TO DOWNLOAD DATA FILES

*Data files contain DXF and S2P files

DIMENSIONS – CASE SIZE A

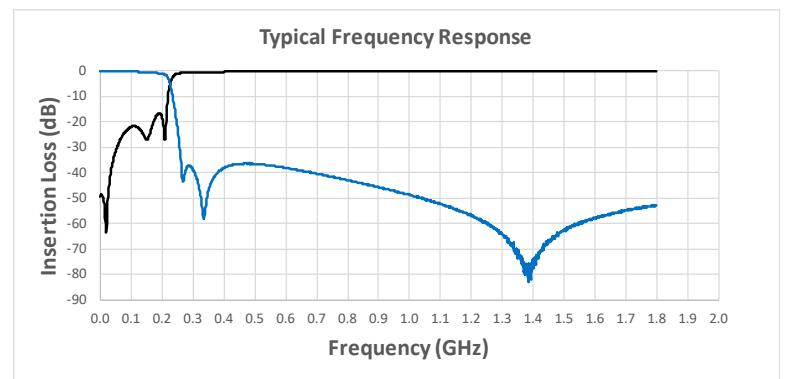
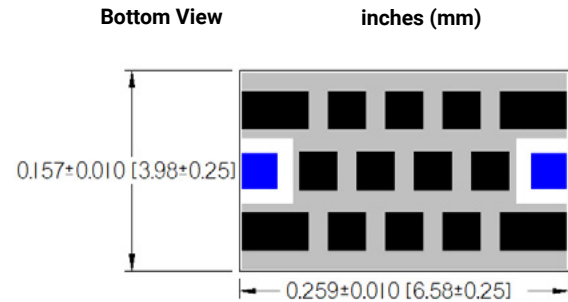

LP0AA0194A7**

ELECTRICAL SPECIFICATIONS

Pass Band	DC - 0.194 GHz	1.2 dB	Max
	DC - 0.194 GHz	0.8 dB	Typ
	-3dB Cutoff	0.241 GHz	Typ
Rejection	0.289 - 2 GHz	30 dB	Min
	N/A	40 dB	Min
Dimension	Thickness	40 Mils	Max
RF Power	Power	4 Watts	Max

[Click here to return to main table.](#)

CLICK HERE TO DOWNLOAD DATA FILES

*Data files contain DXF and S2P files

DIMENSIONS – CASE SIZE A

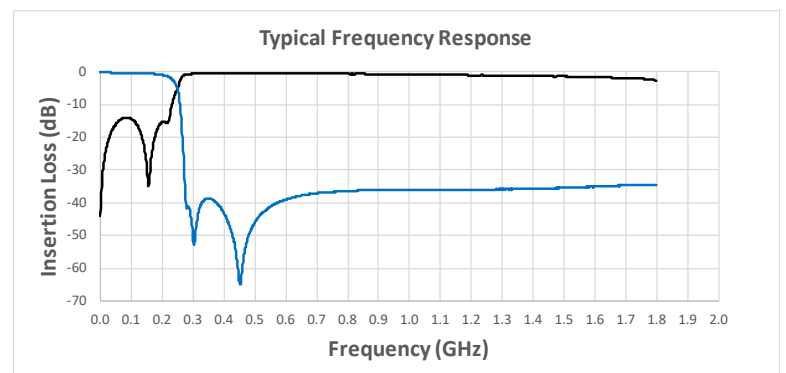
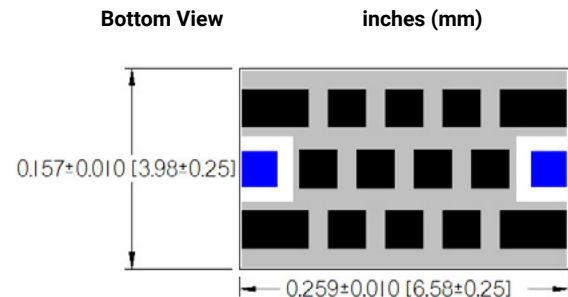

Multilayer Organic (MLO®) Filters

MLO® Low Pass Filters

LP0AA0204A7**

ELECTRICAL SPECIFICATIONS

Pass Band	DC - 0.204 GHz	1.2 dB	Max
	DC - 0.204 GHz	0.8 dB	Typ
	-3dB Cutoff	0.245 GHz	Typ
Rejection	0.293 - 2 GHz	30 dB	Min
	N/A	40 dB	Min
Dimension	Thickness	40 Mils	Max
RF Power	Power	4 Watts	Max

[Click here to return to main table.](#)



CLICK HERE TO DOWNLOAD DATA FILES

*Data files contain DXF and S2P files

DIMENSIONS – CASE SIZE A

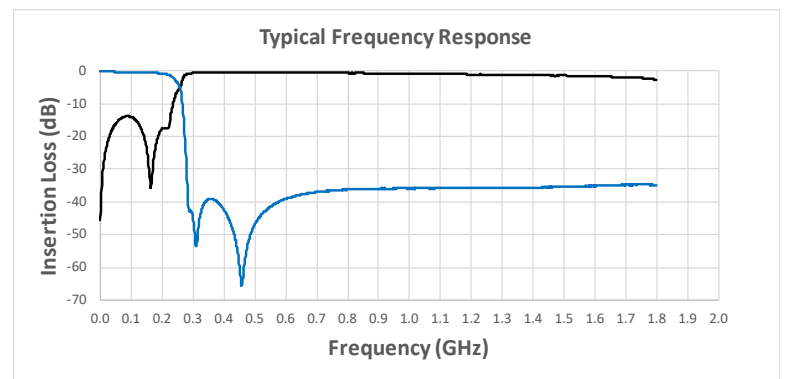
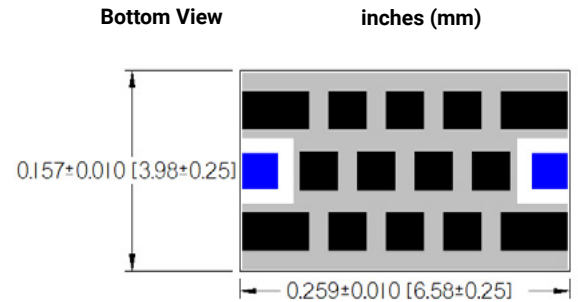

LP0AA0209A7**

ELECTRICAL SPECIFICATIONS

Pass Band	DC - 0.209 GHz	1.2 dB	Max
	DC - 0.209 GHz	0.8 dB	Typ
	-3dB Cutoff	0.252 GHz	Typ
Rejection	0.303 - 2 GHz	30 dB	Min
	N/A	40 dB	Min
Dimension	Thickness	40 Mils	Max
RF Power	Power	4 Watts	Max

[Click here to return to main table.](#)



CLICK HERE TO DOWNLOAD DATA FILES

*Data files contain DXF and S2P files

DIMENSIONS – CASE SIZE A

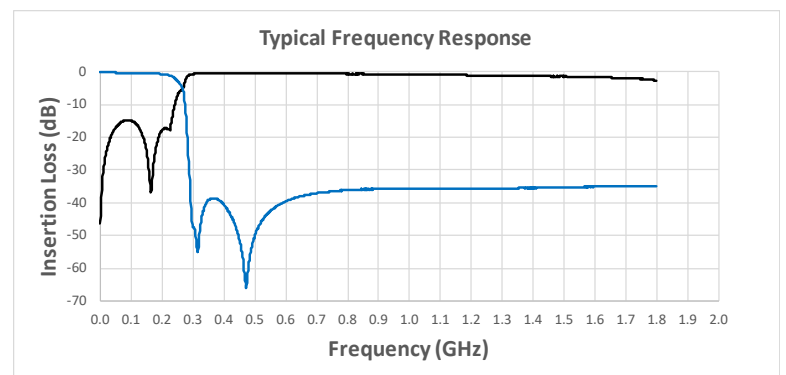
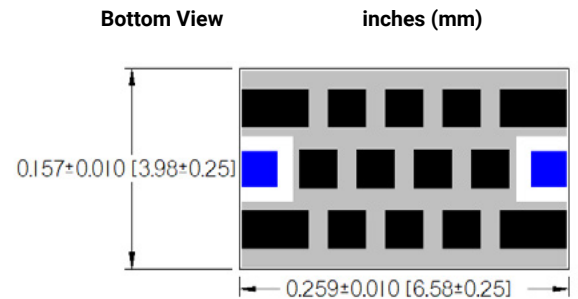

Multilayer Organic (MLO®) Filters

MLO® Low Pass Filters

LP0AA0279A7**

ELECTRICAL SPECIFICATIONS

Pass Band	DC - 0.279 GHz	1.2 dB	Max
	DC - 0.279 GHz	0.8 dB	Typ
	-3dB Cutoff	0.339 GHz	Typ
Rejection	0.398 - 2 GHz	30 dB	Min
	N/A	40 dB	Min
Dimension	Thickness	40 Mils	Max
RF Power	Power	4 Watts	Max

[Click here to return to main table.](#)



CLICK HERE TO DOWNLOAD DATA FILES

*Data files contain DXF and S2P files

DIMENSIONS – CASE SIZE A

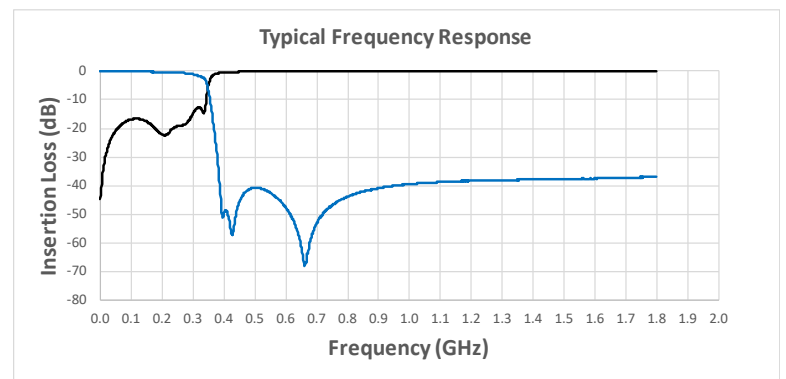
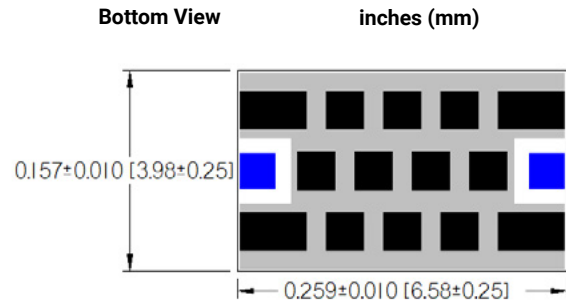

LP0AA0290A7**

ELECTRICAL SPECIFICATIONS

Pass Band	DC - 0.29 GHz	1.2 dB	Max
	DC - 0.29 GHz	0.8 dB	Typ
	-3dB Cutoff	0.351 GHz	Typ
Rejection	0.415 - 2 GHz	30 dB	Min
	N/A	40 dB	Min
Dimension	Thickness	40 Mils	Max
RF Power	Power	4 Watts	Max

[Click here to return to main table.](#)



CLICK HERE TO DOWNLOAD DATA FILES

*Data files contain DXF and S2P files

DIMENSIONS – CASE SIZE A

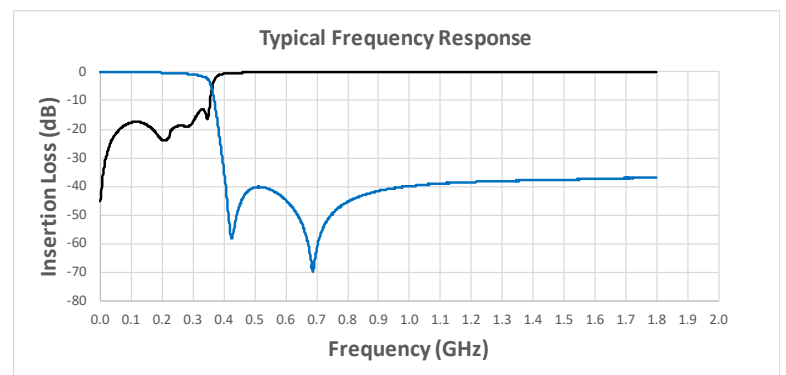
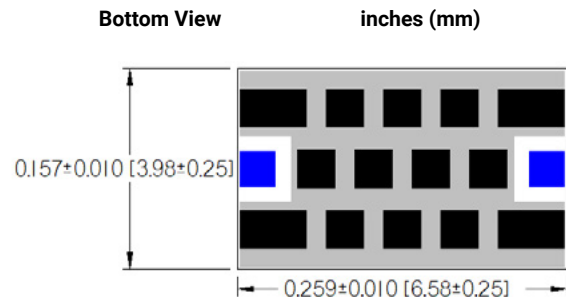

Multilayer Organic (MLO®) Filters

MLO® Low Pass Filters

LP0AA0299A7**

ELECTRICAL SPECIFICATIONS

Pass Band	DC - 0.299 GHz	1.2 dB	Max
	DC - 0.299 GHz	0.8 dB	Typ
	-3dB Cutoff	0.363 GHz	Typ
Rejection	0.427 - 2 GHz	30 dB	Min
	N/A	40 dB	Min
Dimension	Thickness	40 Mils	Max
RF Power	Power	4 Watts	Max

[Click here to return to main table.](#)



CLICK HERE TO DOWNLOAD DATA FILES

*Data files contain DXF and S2P files

DIMENSIONS – CASE SIZE A

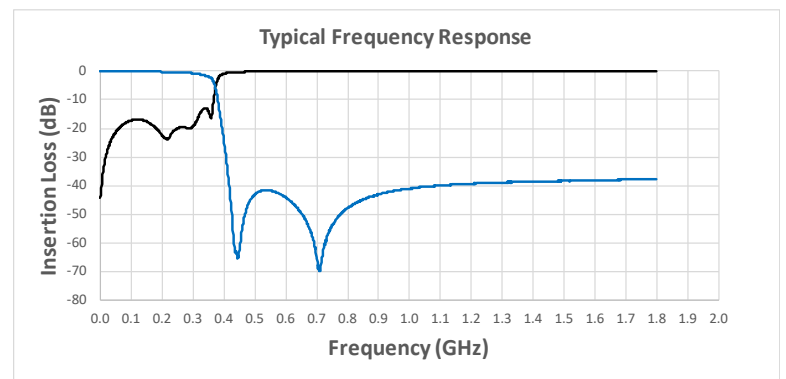
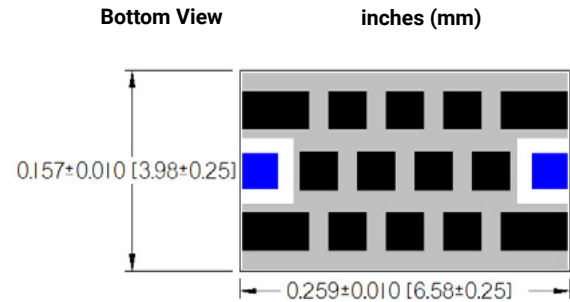

LP0AA0316A7**

ELECTRICAL SPECIFICATIONS

Pass Band	DC - 0.316 GHz	1.2 dB	Max
	DC - 0.316 GHz	0.8 dB	Typ
	-3dB Cutoff	0.378 GHz	Typ
Rejection	0.446 - 2 GHz	30 dB	Min
	N/A	40 dB	Min
Dimension	Thickness	40 Mils	Max
RF Power	Power	4 Watts	Max

[Click here to return to main table.](#)



CLICK HERE TO DOWNLOAD DATA FILES

*Data files contain DXF and S2P files

DIMENSIONS – CASE SIZE A

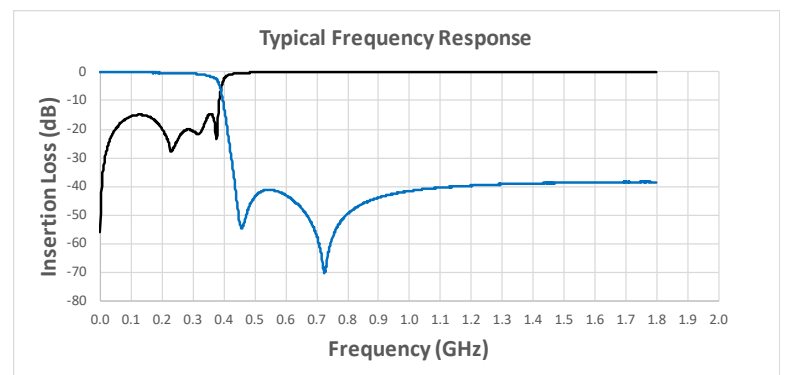
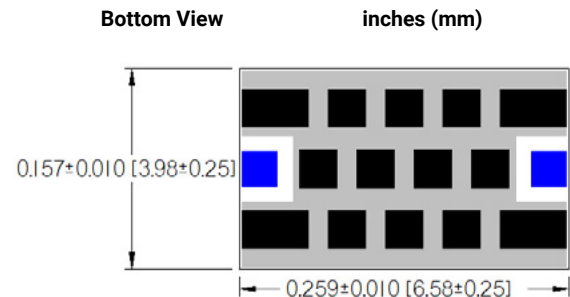

Multilayer Organic (MLO®) Filters

MLO® Low Pass Filters

LP0AA0322A7**

ELECTRICAL SPECIFICATIONS

Pass Band	DC - 0.322 GHz	1.2 dB	Max
	DC - 0.322 GHz	0.8 dB	Typ
	-3dB Cutoff	0.386 GHz	Typ
Rejection	0.454 - 2 GHz	30 dB	Min
	N/A	40 dB	Min
Dimension	Thickness	40 Mils	Max
RF Power	Power	4 Watts	Max

[Click here to return to main table.](#)

CLICK HERE TO DOWNLOAD DATA FILES

*Data files contain DXF and S2P files

DIMENSIONS – CASE SIZE A

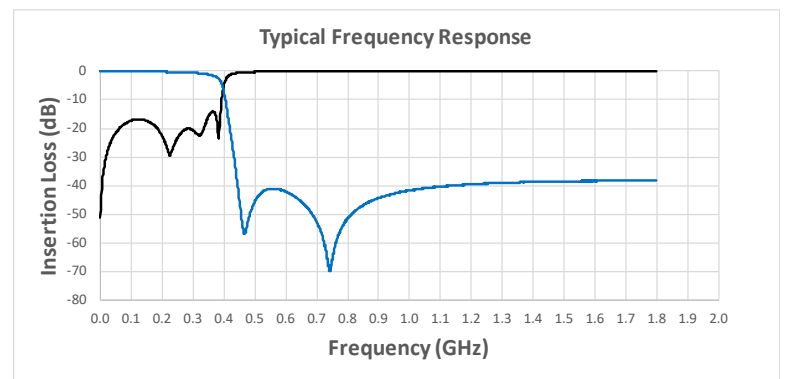
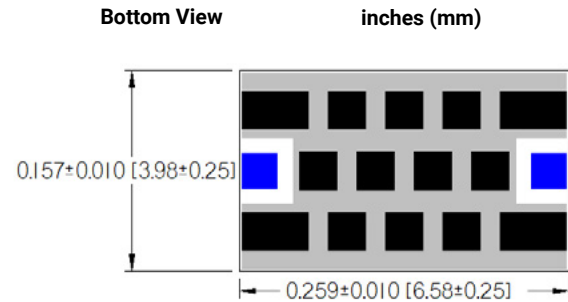

LP0AA0327A7**

ELECTRICAL SPECIFICATIONS

Pass Band	DC - 0.327 GHz	1.2 dB	Max
	DC - 0.327 GHz	0.8 dB	Typ
	-3dB Cutoff	0.392 GHz	Typ
Rejection	0.462 - 2 GHz	30 dB	Min
	N/A	40 dB	Min
Dimension	Thickness	40 Mils	Max
RF Power	Power	4 Watts	Max

[Click here to return to main table.](#)

CLICK HERE TO DOWNLOAD DATA FILES

*Data files contain DXF and S2P files

DIMENSIONS – CASE SIZE A

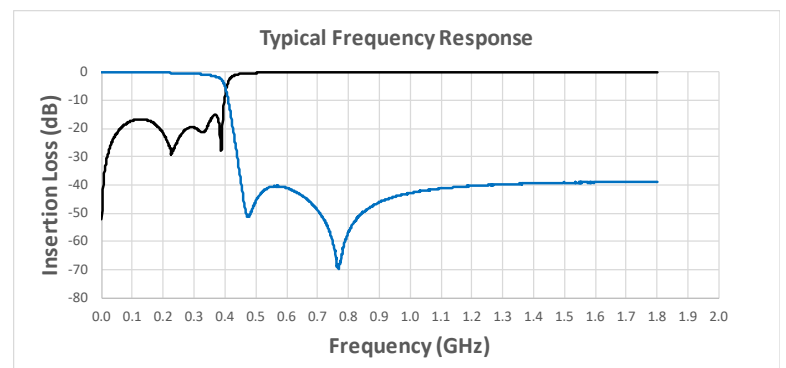
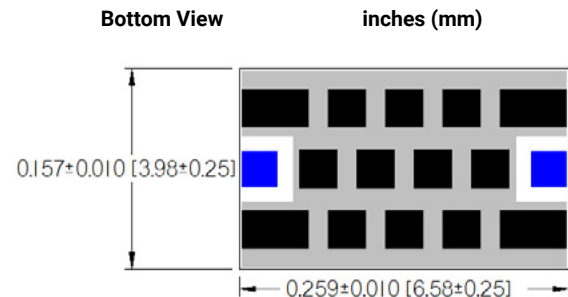

Multilayer Organic (MLO®) Filters

MLO® Band Pass Filters

General Information

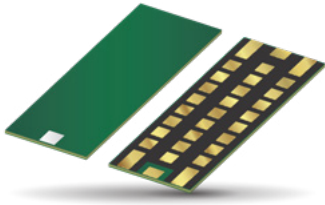

GENERAL DESCRIPTION

The BP series of MLO® High Performance Band Pass Filters exhibit low insertion loss, steep roll-offs, and very high rejection of out of band frequencies. MLO® Band Pass Filters support many frequency bands and multiple wireless standards, and are less than 1.0mm in thickness.

MLO components are low profile devices with best in class performance based on KYOCERA AVX patented multilayer organic high density interconnect technology. MLO components utilize high dielectric constant and low loss materials to realize high Q passive printed elements, such as inductors and capacitors, in a multilayer stack. All MLO components are expansion matched to most organic PCB materials, thereby resulting in improved reliability over standard Si and ceramic devices

FEATURES

- Low insertion loss
- High rejection out-of-band
- Steep roll-off
- 50Ω Impedance
- Expansion matched to PCB
- Surface Mount
- RoHS Compliant

APPLICATIONS

- Wireless Communications Systems
- Military Radios
- EMS Radios
- UAVs
- Basestations
- Wireless access points and terminals
- Instrumentation

LAND GRID ARRAY ADVANTAGES

- Inherent Low Profile
- Excellent Solderability
- Low Parasitics
- Better Heat Dissipation

HOW TO ORDER

BP ↓ Series Band Pass Filters	0F ↓ Case Size 0A = 2616 0B = 3116 0C = 3416 0D = 4016 0E = 4617 0F = 5021	A ↓ Type	1100 ↓ Frequency In MHz	A ↓ Standard Testing	7 ↓ Termination 7 – Gold	00 ↓ Package Code 00 – Waffle Pack TR – 1000 pcs Tape & Reel TR1250 – 250 pcs Tape & Reel
--	--	------------------------------	--	--	---	--

QUALITY INSPECTION

Finished Parts are 100% electrically tested



LEAD-FREE

LEAD-FREE COMPATIBLE COMPONENT



RoHS COMPLIANT

For RoHScompliant products, please select correct termination style

TERMINATION

All finishes are compatible with automatic soldering technologies: Pb free reflow, wave soldering, vapor phase, and manual soldering.

OPERATING TEMPERATURE

-55°C to +85°C



S2P FILES, DRAWING AND OTHER INFORMATION AVAILABLE IN LINK ON INDIVIDUAL DATASHEETS

ELECTRICAL SPECIFICATIONS

Part Number	Fc		Passband Ripple <1.5dB			Insertion Loss < 5dB				Low Band		High Band				Rated RF Power (W)
	GHz	dB	<1.5 dB Ripple			< 5 dB				DC - 30 dB	DC - 40 dB	30 dB		40 dB		
			Min	Max	BW	Min	Max	BW	Typ	Max	Max	Entry	Exit	Entry	Exit	
BP0IA0110A7**	0.110	1.7	0.092	0.135	0.043	0.088	0.138	0.050	2.2	0.688	0.063	0.181	1.000	0.187	0.950	1
BP0IA0115A7**	0.115	1.7	0.094	0.138	0.044	0.090	0.142	0.051	2.4	0.066	0.064	0.187	1.000	0.192	0.950	1
BP0IA0120A7**	0.120	1.7	0.095	0.143	0.048	0.092	0.146	0.054	2.5	0.069	0.066	0.191	1.000	0.197	0.950	1
BP0IA0170A7**	0.170	1.4	0.132	0.224	0.092	0.128	0.228	0.100	2.0	0.096	0.093	0.297	1.000	0.307	0.950	1
BP0IA0175A7**	0.175	1.4	0.135	0.231	0.096	0.132	0.235	0.103	2.3	0.100	0.096	0.304	1.000	0.314	0.950	1
BP0IA0180A7**	0.180	1.6	0.143	0.228	0.085	0.137	0.234	0.097	2.2	0.103	0.099	0.312	1.000	0.322	0.950	1
BP0EA0270A7**	0.270	1.6	0.231	0.316	0.085	0.224	0.325	0.100	2.4	0.161	0.155	0.424	2.000	0.444	2.000	1
BP0EA0280A7**	0.280	1.7	0.234	0.321	0.088	0.227	0.327	0.100	2.2	0.164	0.158	0.431	2.000	0.447	2.000	1
BP0EA0290A7**	0.290	1.7	0.244	0.339	0.096	0.241	0.345	0.105	2.3	0.170	0.164	0.454	2.000	0.473	2.000	1
BP0EA0400A7**	0.400	1.3	0.303	0.494	0.191	0.296	0.500	0.203	1.9	0.215	0.206	0.660	2.500	0.687	2.100	1
BP0EA0420A7**	0.420	1.3	0.316	0.514	0.198	0.309	0.520	0.211	2.0	0.224	0.215	0.690	2.500	0.719	2.000	1
BP0EA0430A7**	0.430	1.3	0.323	0.529	0.207	0.316	0.535	0.219	1.9	0.230	0.221	0.706	2.500	0.736	2.000	1
BP0DA0585A7**	0.585	1.3	0.472	0.735	0.262	0.461	0.745	0.284	2.1	0.360	-	0.985	3.000	-	-	1
BP0DA0595A7**	0.595	1.3	0.478	0.745	0.267	0.467	0.756	0.289	1.9	0.365	-	1.002	3.000	-	-	1
BP0DA0650A7**	0.650	1.3	0.485	0.776	0.291	0.490	0.787	0.297	2.0	0.374	-	1.030	3.000	-	-	1

Click on part number to see full specifications

**Packaging: 00 = waffle pack, TR = 1000pcs T&R, TR1250 = 250pcs T&R



The Important Information/Disclaimer is incorporated in the catalog where these specifications came from or available online at www.kyocera-avx.com/disclaimer/ by reference and should be reviewed in full before placing any order.

Multilayer Organic (MLO®) Filters

MLO® Band Pass Filters

ELECTRICAL SPECIFICATIONS - CONTINUED

Part Number	Fc		Passband Ripple <1.5dB			Insertion Loss < 5dB				Low Band		High Band				Rated RF Power (W)
	GHz	dB	<1.5 dB Ripple			< 5 dB				DC - 30 dB	DC - 40 dB	30 dB		40 dB		
			Min	Max	BW	Min	Max	BW	Typ	Max	Max	Entry	Exit	Entry	Exit	
BP0CA0770A7**	0.770	0.97	0.628	0.954	0.326	0.620	0.970	0.350	1.97	0.480	0.460	1.190	4.500	1.230	4.000	1
BP0CA0810A7**	0.810	1.3	0.668	0.985	0.317	0.657	1.006	0.349	2.00	0.511	0.500	1.256	4.000	1.290	4.000	1
BP0CA0825A7**	0.825	1.3	0.680	0.985	0.305	0.668	1.021	0.353	2.0	0.513	0.504	1.261	4.000	1.296	4.000	1
BP0CA0855A7**	0.855	1.4	0.708	1.032	0.323	0.691	1.053	0.361	2.0	0.542	0.526	1.314	4.000	1.347	3.800	1
BP0CA1070A7**	1.070	1.1	0.887	1.313	0.426	0.864	1.329	0.465	2.1	0.693	0.672	1.647	4.000	1.682	4.000	1
BP0CA1090A7**	1.090	1.3	0.898	1.329	0.431	0.881	1.350	0.469	2.1	0.698	0.683	1.676	4.500	1.716	4.275	1
BP0CA1100A7**	1.100	0.95	0.881	1.365	0.484	0.860	1.390	0.530	1.62	0.680	0.660	1.680	5.000	1.730	4.500	1
BP0FA1100A7**	1.100	1.19	0.915	1.340	0.425	0.870	1.390	0.520	1.97	0.670	0.640	1.720	16.700	1.780	11.110	1
BP0FA1130A7**	1.130	1.35	0.928	1.398	0.470	0.890	1.440	0.550	2.18	0.680	0.660	1.760	15.540	1.790	11.700	1
BP0CA1160A7**	1.160	1.3	0.943	1.340	0.397	0.910	1.397	0.486	2.0	0.719	0.704	1.727	4.750	1.820	4.275	1
BP0FA1190A7**	1.190	1.28	1.031	1.387	0.356	0.990	1.440	0.450	1.96	0.760	0.740	1.740	18.000	1.780	16.290	1
BP0CA1610A7**	1.610	0.89	1.290	2.006	0.716	1.270	2.050	0.780	1.74	1.040	1.020	2.500	9.000	2.570	6.260	1
BP0EA1950A7**	1.950	0.94	1.486	2.573	1.087	1.440	2.640	1.200	1.46	1.190	1.160	3.140	9.000	3.220	7.500	1
BP0EA1980A7**	1.980	0.98	1.506	2.629	1.123	1.470	2.680	1.210	1.43	1.210	1.170	3.270	9.000	3.370	7.620	1
BP0EA2000A7**	2.000	1.8	1.878	2.121	0.243	1.838	2.18	0.343	2.2	1.48	1.454	2.675	9.000	2.729	8.000	1
BP0EA2055A7**	2.055	1.8	1.944	2.180	0.237	1.902	2.223	0.321	2.1	1.518	1.492	2.770	9.000	2.817	8.000	1
BP0EA2090A7**	2.090	1.08	1.580	2.759	1.179	1.450	2.840	1.390	1.33	1.280	1.230	3.400	9.000	3.600	7.920	1
BP0EA2135A7**	2.135	1.8	2.002	2.266	0.263	1.961	2.325	0.363	2.2	1.561	1.529	2.841	9.000	2.882	8.000	1
BP0BA2150A7**	2.150	1.4	1.768	2.548	0.780	1.750	2.579	0.829	1.8	1.344	-	3.305	9.000	-	-	1
BP0BA2260A7**	2.260	1.3	1.838	2.642	0.804	1.820	2.673	0.854	1.9	1.397	-	3.444	9.000	-	-	1
BP0BA2290A7**	2.290	1.2	1.884	2.751	0.868	1.866	2.715	0.849	1.8	1.433	-	3.548	9.000	-	-	1
BP0EA2423A7**	2.423	1.6	2.168	2.646	0.478	2.138	2.746	0.609	2.3	1.758	1.732	3.290	9.000	3.325	9.000	1
BP0EA2500A7**	2.500	1.36	2.084	3.003	0.919	2.020	3.210	1.190	2.38	1.690	1.640	3.710	9.000	3.800	7.500	1
BP0EA2510A7**	2.510	1.6	2.245	2.774	0.529	2.209	2.832	0.623	2.1	1.822	1.796	3.366	9.000	3.402	9.000	1
BP0EA2540A7**	2.540	1.11	2.077	3.161	1.084	2.020	3.210	1.190	1.88	1.700	1.640	3.800	8.300	3.900	7.800	1
BP0EA2568A7**	2.568	1.9	2.286	2.864	0.578	2.256	2.923	0.667	2.1	1.871	1.844	3.485	10.000	3.521	9.000	1
BP0EA2620A7**	2.620	1.55	2.141	3.169	1.028	2.090	3.280	1.190	2.21	1.740	1.680	3.910	7.800	3.960	7.700	1
BP0EA3060A7**	3.060	1.6	2.783	3.340	0.558	2.741	3.42	0.68	2.1	2.261	2.223	4.099	11.000	4.140	10.200	1
BP0EA3123A7**	3.123	1.5	2.847	3.430	0.584	2.799	3.485	0.685	2.2	2.319	2.288	4.153	12.000	4.200	9.000	1
BP0EA3180A7**	3.180	0.84	2.505	4.016	1.510	2.450	4.140	1.690	1.67	1.810	1.750	5.250	18.430	5.460	15.500	1
BP0BA3270A7**	3.270	2.2	3.242	3.314	0.071	3.156	3.381	0.225	2.3	2.334	2.219	4.337	9.000	4.580	9.000	1
BP0BA3280A7**	3.280	2.2	3.225	3.340	0.116	3.150	3.412	0.262	2.2	2.361	2.246	4.376	9.000	4.700	9.000	1
BP0EA3284A7**	3.284	1.5	3.019	3.586	0.567	2.972	3.629	0.657	2.1	2.447	2.292	4.324	11.500	5.091	9.000	1
BP0EA3310A7**	3.310	0.97	2.695	4.107	1.412	2.620	4.190	1.570	1.85	1.910	1.860	5.220	19.050	5.410	15.940	1
BP0BA3350A7**	3.350	2.3	3.282	3.429	0.146	3.208	3.506	0.299	2.3	2.386	2.267	4.480	9.000	4.580	9.000	1
BP0EA3430A7**	3.430	0.83	2.683	4.370	1.687	2.640	4.460	1.820	1.8	1.950	1.890	5.590	20.000	5.830	16.000	1
BP0AA3580A7**	3.580	1.2	2.972	4.304	1.332	2.943	4.351	1.408	1.6	2.068	-	5.292	9.000	6.300	9.000	1
BP0EA3597A7**	3.597	1.9	3.325	3.923	0.597	3.237	3.998	0.76	2.4	2.621	2.538	4.896	10.00	4.93	9.000	1
BP0BA3630A7**	3.630	2.1	3.513	3.746	0.233	3.438	3.829	0.392	2.2	2.594	2.460	4.884	9.000	5.039	9.000	1
BP0AA3700A7**	3.700	1.1	3.046	4.481	1.435	3.020	4.533	1.513	1.8	2.152	-	5.500	9.000	6.300	9.000	1
BP0EA3720A7**	3.720	2	3.408	3.981	0.573	3.319	4.169	0.85	2.5	2.661	2.575	5.051	12.500	5.098	9.000	1
BP0BA3750A7**	3.750	2	3.657	3.835	0.178	3.588	3.918	0.330	2.1	2.694	2.558	5.097	9.000	5.241	9.000	1
BP0AA3790A7**	3.790	1	3.200	4.589	1.389	3.150	4.646	1.496	2.1	2.199	-	5.661	9.000	6.060	9.000	1
BP0EA3827A7**	3.827	2.1	3.508	4.169	0.661	3.408	4.297	0.889	2.4	2.726	2.640	5.180	14.000	5.222	9.000	1
BP0BA3900A7**	3.900	2	3.847	3.960	0.112	3.755	4.058	0.304	2.2	2.735	2.600	5.229	9.000	6.000	9.000	1
BP0EA4260A7**	4.260	1.3	3.389	5.422	2.032	3.325	5.462	2.136	2.0	2.621	2.261	6.920	9.000	-	-	1
BP0EA4363A7**	4.363	1.6	3.933	4.847	0.914	3.863	4.927	1.064	2.2	3.121	3.009	6.019	13.000	6.072	10.500	1
BP0EA4400A7**	4.400	1.1	3.456	5.627	2.171	3.420	5.670	2.250	1.8	2.699	2.613	7.109	9.000	-	-	1
BP0EA4440A7**	4.440	1.1	3.554	5.513	1.959	3.490	5.660	2.170	1.78	2.890	2.790	7.060	13.800	7.390	9.260	1
BP0EA4550A7**	4.550	1.7	4.052	5.071	1.019	3.922	5.16	1.239	2.0	3.196	3.084	6.278	15.500	6.302	11.000	1
BP0EA4583A7**	4.583	1.1	3.542	5.932	2.390	3.521	5.979	2.459	1.6	2.770	2.667	7.400	9.000	-	-	1
BP0EA4600A7**	4.600	1.14	3.806	5.696	1.890	3.660	5.780	2.120	1.79	2.990	2.900	7.150	9.680	7.500	9.550	1
BP0EA4649A7**	4.649	1.8	4.371	5.285	0.914	4.016	5.381	1.365	2.7	3.259	3.159	6.497	12.000	6.596	11.000	1
BP0EA4680A7**	4.680	1.18	3.743	5.776	2.033	3.700	5.930	2.230	1.77	3.050	2.960	7.370	9.860	7.730	8.400	1

Click on part number to see full specifications

**Packaging: 00 = waffle pack, TR = 1000pcs T&R, TR\250 = 250pcs T&R

Multilayer Organic (MLO®) Filters

MLO® Band Pass Filters

MECHANICAL DIMENSIONS:

inches (mm)

Case Size	Length	Width	Height
A 2616	0.259±0.010 (6.579±0.254)	0.157±0.010 (3.975±0.254)	Varies - see part specification
B 3116	0.306±0.010 (7.785±0.254)	0.156±0.010 (3.975±0.254)	Varies - see part specification
C 3416	0.342±0.010 (8.674±0.254)	0.157±0.010 (3.975±0.254)	Varies - see part specification
D 4016	0.401±0.010 (10.198±0.254)	0.156±0.010 (3.975±0.254)	Varies - see part specification
E 4617	0.460±0.010 (11.684±0.254)	0.170±0.010 (4.318±0.254)	Varies - see part specification
E1 4617	0.460±0.010 (11.684±0.254)	0.174±0.010 (4.4196±0.254)	Varies - see part specification
E2 4614	0.460±0.010 (11.684±0.254)	0.144±0.010 (3.6576±0.254)	Varies - see part specification
F 5021	0.512±0.010 (12.992±0.254)	0.207±0.010 (5.245±0.254)	Varies - see part specification
I 6025	.600±0.010 (15.24±0.254)	0.250±0.010 (6.35±0.254)	Varies - see part specification

BP01A0110A7**

ELECTRICAL SPECIFICATIONS

	Min (GHz)	Max (GHz)		
Pass Band	0.110		1.7	dB Fc Typ
	0.088	0.138	5.0	dB Max
	0.088	0.138	2.2	dB Typ
	0.092	0.135	1.5	dB Ripple
Rejection	DC	0.688	30	dB Min
	0.181	1.000	30	dB Min
	DC	0.063	40	dB Min
	0.187	0.950	40	dB Min
Dimension	Thickness		40	Mils Max
RF Power	Power		1	Watts Max

[Click here to return to main table.](#)

CLICK HERE TO DOWNLOAD DATA FILES

*Data files contain DXF and S2P files

DIMENSIONS – CASE SIZE I

Bottom View inches (mm)

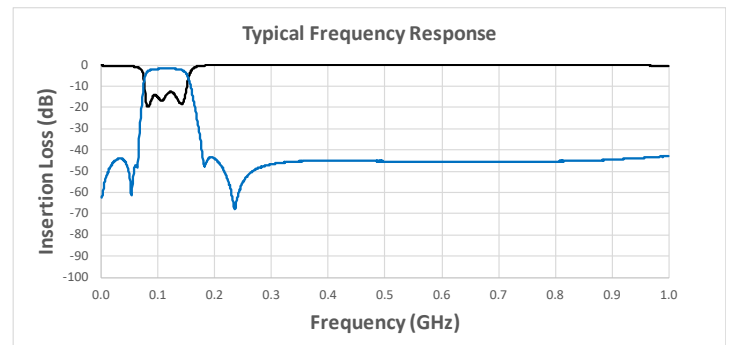
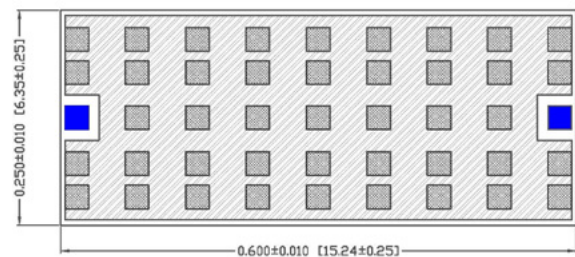

Multilayer Organic (MLO®) Filters

MLO® Band Pass Filters

BP01A0115A7**

ELECTRICAL SPECIFICATIONS

	Min (GHz)	Max (GHz)		
Pass Band	0.115		1.7	dB Fc Typ
	0.090	0.142	5.0	dB Max
	0.090	0.142	2.4	dB Typ
	0.094	0.138	1.5	dB Ripple
Rejection	DC	0.066	30	dB Min
	0.187	1.000	30	dB Min
	DC	0.064	40	dB Min
	0.192	0.950	40	dB Min
Dimension	Thickness		40	Mils Max
RF Power	Power		1	Watts Max

[Click here to return to main table.](#)



CLICK HERE TO DOWNLOAD DATA FILES

*Data files contain DXF and S2P files

DIMENSIONS – CASE SIZE I

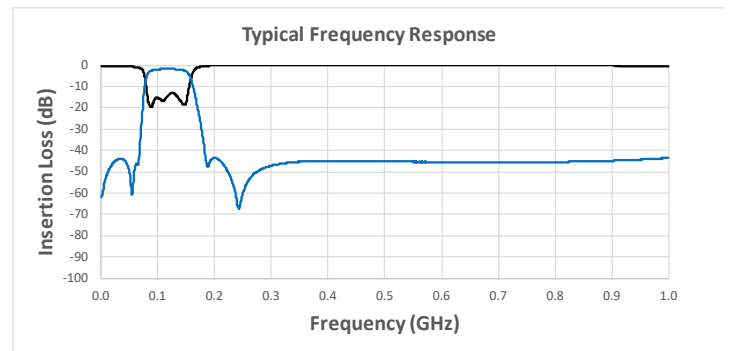
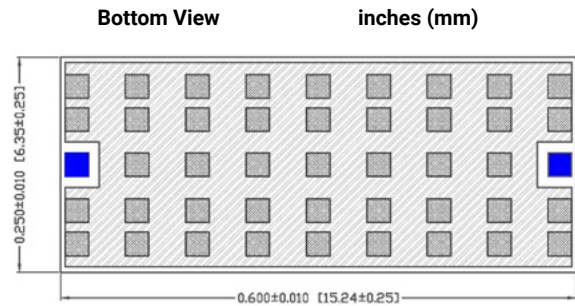

BP01A0120A7**

ELECTRICAL SPECIFICATIONS

	Min (GHz)	Max (GHz)		
Pass Band	0.120		1.7	dB Fc Typ
	0.092	0.146	5.0	dB Max
	0.092	0.146	2.5	dB Typ
	0.095	0.143	1.5	dB Ripple
Rejection	DC	0.069	30	dB Min
	0.191	1.000	30	dB Min
	DC	0.066	40	dB Min
	0.197	0.950	40	dB Min
Dimension	Thickness		40	Mils Max
RF Power	Power		1	Watts Max

[Click here to return to main table.](#)



CLICK HERE TO DOWNLOAD DATA FILES

*Data files contain DXF and S2P files

DIMENSIONS – CASE SIZE I

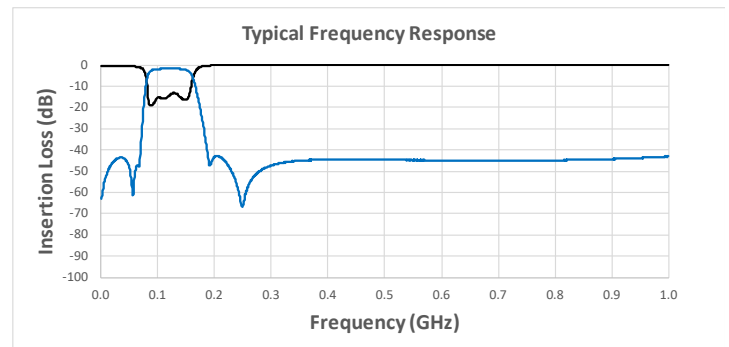
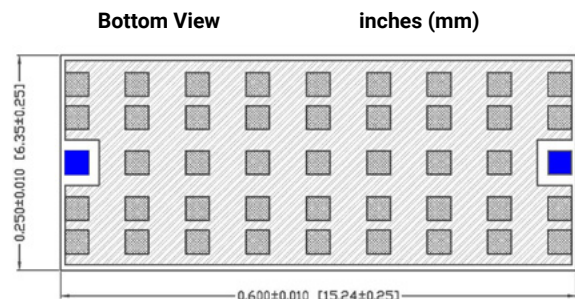

Multilayer Organic (MLO®) Filters

MLO® Band Pass Filters

BP01A0170A7**

ELECTRICAL SPECIFICATIONS

	Min (GHz)	Max (GHz)		
Pass Band	0.170		1.4	dB Fc Typ
	0.128	0.228	5.0	dB Max
	0.128	0.228	2	dB Typ
	0.132	0.224	1.5	dB Ripple
Rejection	DC	0.096	30	dB Min
	0.297	1.000	30	dB Min
	DC	0.093	40	dB Min
	0.307	0.950	40	dB Min
Dimension	Thickness		40	Mils Max
RF Power	Power		1	Watts Max

[Click here to return to main table.](#)



CLICK HERE TO DOWNLOAD DATA FILES

*Data files contain DXF and S2P files

DIMENSIONS – CASE SIZE I

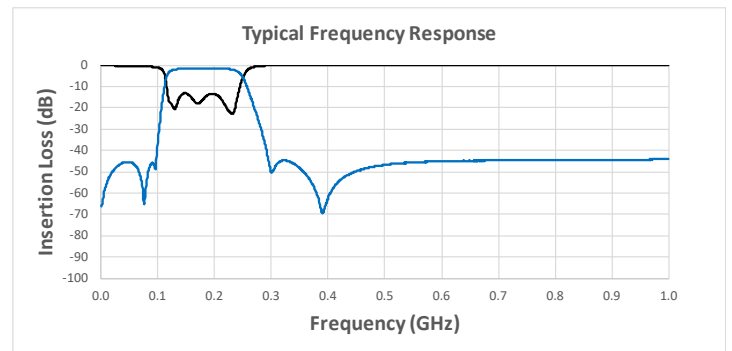
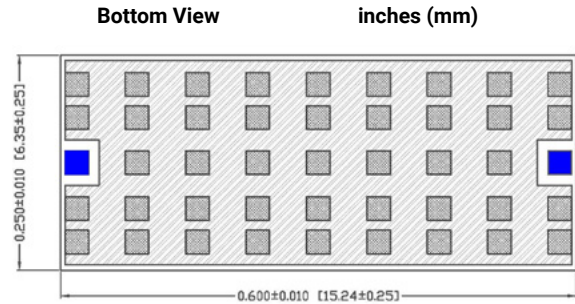

BP01A0175A7**

ELECTRICAL SPECIFICATIONS

	Min (GHz)	Max (GHz)		
Pass Band	0.175		1.4	dB Fc Typ
	0.132	0.235	5.0	dB Max
	0.132	0.235	2.3	dB Typ
	0.135	0.231	1.5	dB Ripple
Rejection	DC	0.100	30	dB Min
	0.304	1.000	30	dB Min
	DC	0.096	40	dB Min
	0.314	0.950	40	dB Min
Dimension	Thickness		40	Mils Max
RF Power	Power		1	Watts Max

[Click here to return to main table.](#)



CLICK HERE TO DOWNLOAD DATA FILES

*Data files contain DXF and S2P files

DIMENSIONS – CASE SIZE I

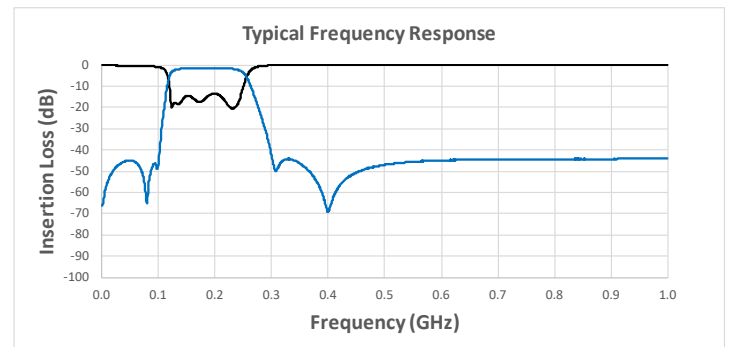
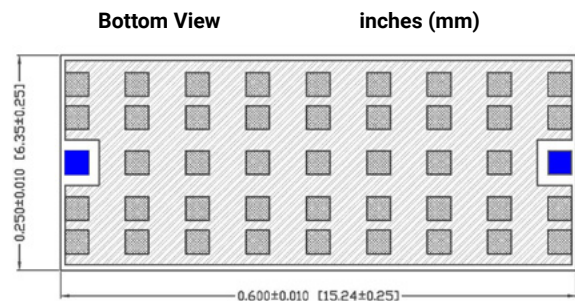

Multilayer Organic (MLO®) Filters

MLO® Band Pass Filters

BP0IA0180A7**

ELECTRICAL SPECIFICATIONS

	Min (GHz)	Max (GHz)		
Pass Band	0.180		1.6	dB Fc Typ
	0.137	0.234	5.0	dB Max
	0.137	0.234	2.2	dB Typ
	0.143	0.228	1.5	dB Ripple
Rejection	DC	0.103	30	dB Min
	0.312	1.000	30	dB Min
	DC	0.099	40	dB Min
Dimension	Thickness		40	Mils Max
	RF Power		Power	1

[Click here to return to main table.](#)

CLICK HERE TO DOWNLOAD DATA FILES

*Data files contain DXF and S2P files

DIMENSIONS – CASE SIZE I

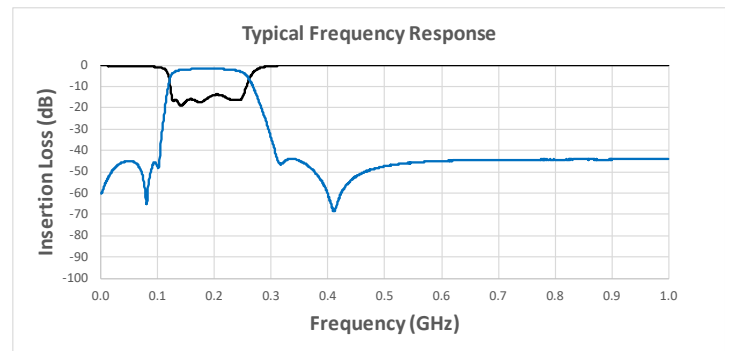
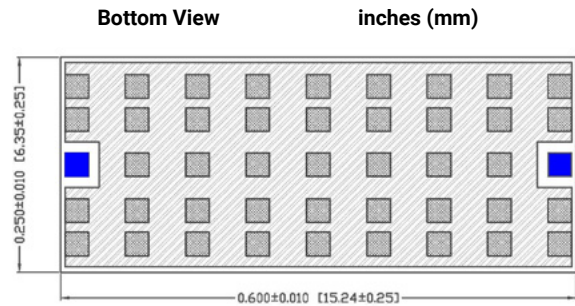

BP0EA0270A7**

ELECTRICAL SPECIFICATIONS

	Min (GHz)	Max (GHz)		
Pass Band	0.270		1.6	dB Fc Typ
	0.224	0.325	5.0	dB Max
	0.224	0.325	2.4	dB Typ
	0.231	0.316	1.5	dB Ripple
Rejection	DC	0.161	30	dB Min
	0.424	2.000	30	dB Min
	DC	0.155	40	dB Min
Dimension	Thickness		40	Mils Max
	RF Power		Power	1

[Click here to return to main table.](#)

CLICK HERE TO DOWNLOAD DATA FILES

*Data files contain DXF and S2P files

DIMENSIONS – CASE SIZE E

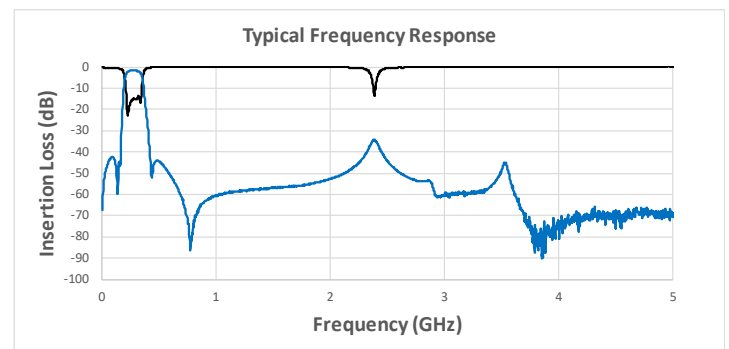
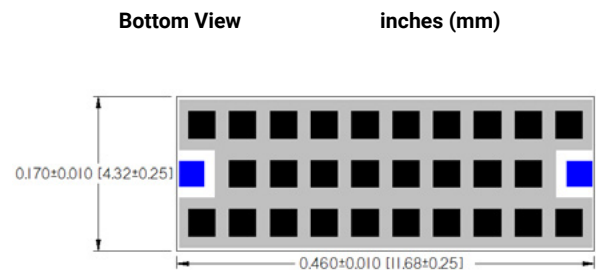

Multilayer Organic (MLO®) Filters

MLO® Band Pass Filters

BPOEA0280A7**

ELECTRICAL SPECIFICATIONS

	Min (GHz)	Max (GHz)		
Pass Band	0.280		1.7	dB Fc Typ
	0.227	0.327	5.0	dB Max
	0.227	0.327	2.2	dB Typ
	0.234	0.321	1.5	dB Ripple
Rejection	DC	0.164	30	dB Min
	0.431	2.000	30	dB Min
	DC	0.158	40	dB Min
	0.447	2.000	40	dB Min
Dimension	Thickness		40	Mils Max
RF Power	Power		1	Watts Max

[Click here to return to main table.](#)



CLICK HERE TO DOWNLOAD DATA FILES

*Data files contain DXF and S2P files

DIMENSIONS – CASE SIZE E

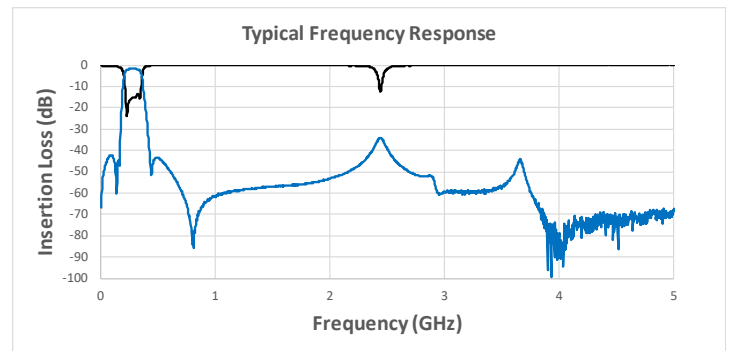
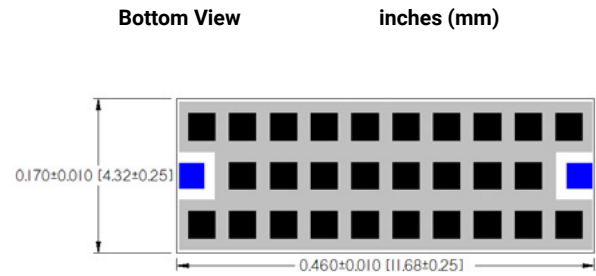

BPOEA0290A7**

ELECTRICAL SPECIFICATIONS

	Min (GHz)	Max (GHz)		
Pass Band	0.290		1.7	dB Fc Typ
	0.241	0.345	5.0	dB Max
	0.241	0.345	2.3	dB Typ
	0.244	0.339	1.5	dB Ripple
Rejection	DC	0.170	30	dB Min
	0.454	2.000	30	dB Min
	DC	0.164	40	dB Min
	0.473	2.000	40	dB Min
Dimension	Thickness		40	Mils Max
RF Power	Power		1	Watts Max

[Click here to return to main table.](#)



CLICK HERE TO DOWNLOAD DATA FILES

*Data files contain DXF and S2P files

DIMENSIONS – CASE SIZE E

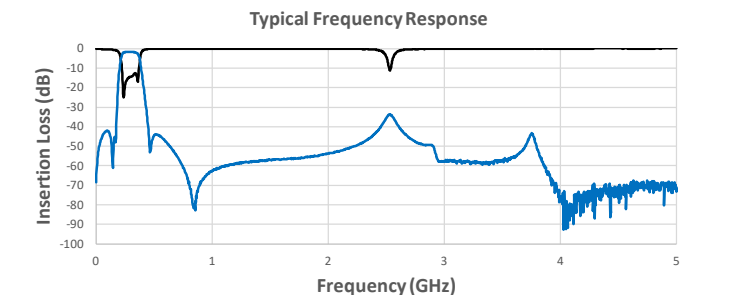
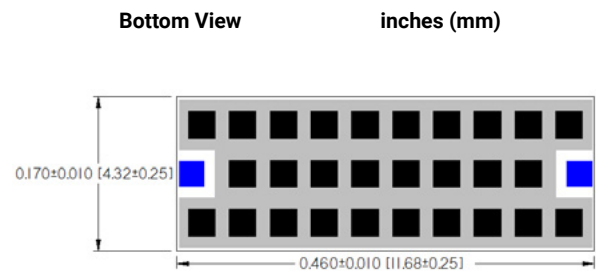

Multilayer Organic (MLO®) Filters

MLO® Band Pass Filters

BP0EA0400A7**

ELECTRICAL SPECIFICATIONS

	Min (GHz)	Max (GHz)		
Pass Band	0.400		1.3	dB Fc Typ
	0.296	0.500	5.0	dB Max
	0.296	0.500	1.9	dB Typ
	0.303	0.494	1.5	dB Ripple
Rejection	DC	0.215	30	dB Min
	0.660	2.500	30	dB Min
	DC	0.206	40	dB Min
Dimension	Thickness		40	Mils Max
	RF Power		Power	1 Watts Max

[Click here to return to main table.](#)

CLICK HERE TO DOWNLOAD DATA FILES

*Data files contain DXF and S2P files

DIMENSIONS – CASE SIZE E

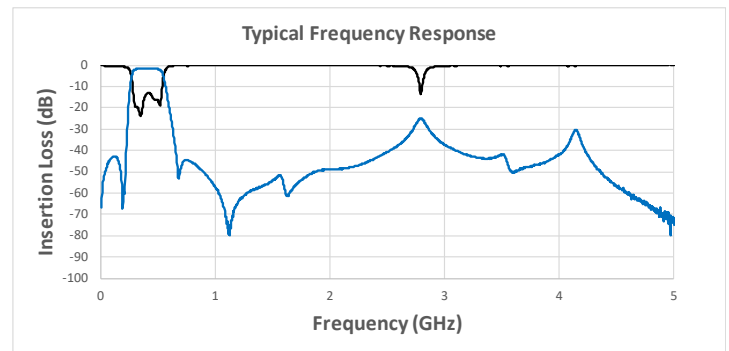
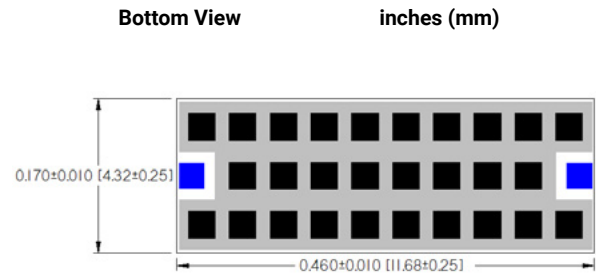

BP0EA0420A7**

ELECTRICAL SPECIFICATIONS

	Min (GHz)	Max (GHz)		
Pass Band	0.420		1.3	dB Fc Typ
	0.309	0.520	5.0	dB Max
	0.309	0.520	2	dB Typ
	0.316	0.514	1.5	dB Ripple
Rejection	DC	0.224	30	dB Min
	0.690	2.500	30	dB Min
	DC	0.215	40	dB Min
Dimension	Thickness		40	Mils Max
	RF Power		Power	1 Watts Max

[Click here to return to main table.](#)

CLICK HERE TO DOWNLOAD DATA FILES

*Data files contain DXF and S2P files

DIMENSIONS – CASE SIZE E

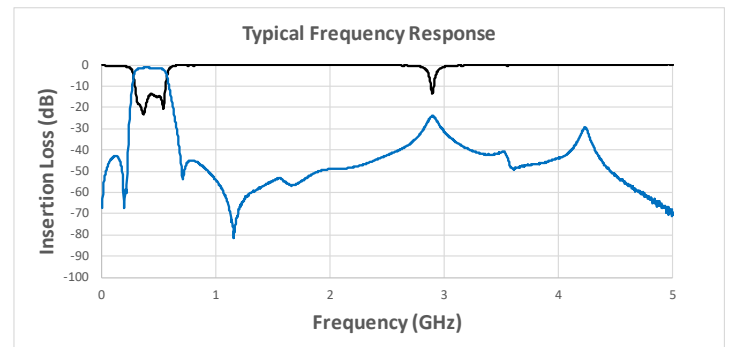
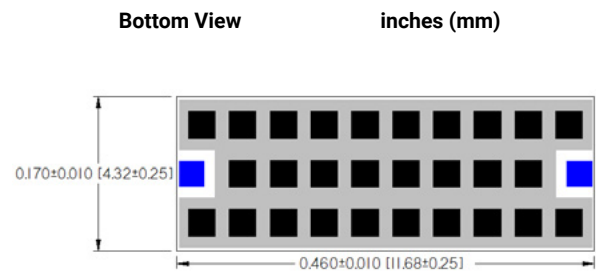

Multilayer Organic (MLO®) Filters

MLO® Band Pass Filters

BP0EA0430A7**

ELECTRICAL SPECIFICATIONS

	Min (GHz)	Max (GHz)		
Pass Band	0.430		1.3	dB Fc Typ
	0.316	0.535	5.0	dB Max
	0.316	0.535	1.9	dB Typ
	0.323	0.529	1.5	dB Ripple
Rejection	DC	0.230	30	dB Min
	0.706	2.500	30	dB Min
	DC	0.221	40	dB Min
	0.736	2.000	40	dB Min
Dimension	Thickness		40	Mils Max
RF Power	Power		1	Watts Max

[Click here to return to main table.](#)



CLICK HERE TO DOWNLOAD DATA FILES

*Data files contain DXF and S2P files

DIMENSIONS – CASE SIZE E

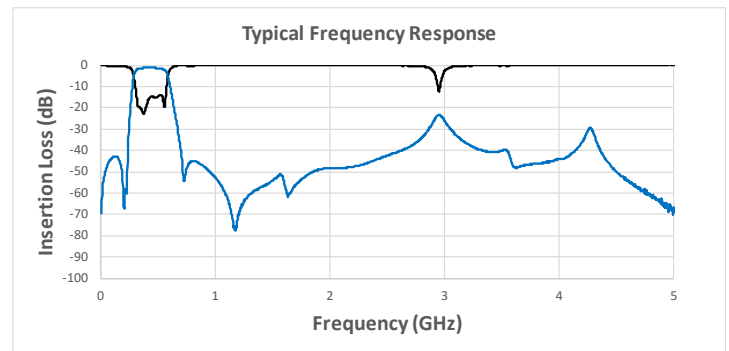
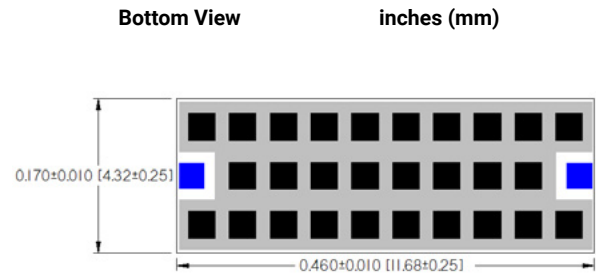

BP0DA0585A7**

ELECTRICAL SPECIFICATIONS

	Min (GHz)	Max (GHz)		
Pass Band	0.585		1.3	dB Fc Typ
	0.461	0.745	5.0	dB Max
	0.461	0.745	2.1	dB Typ
	0.472	0.735	1.5	dB Ripple
Rejection	DC	0.360	30	dB Min
	0.985	3.000	30	dB Min
Dimension	Thickness		40	Mils Max
RF Power	Power		1	Watts Max

[Click here to return to main table.](#)



CLICK HERE TO DOWNLOAD DATA FILES

*Data files contain DXF and S2P files

DIMENSIONS – CASE SIZE D

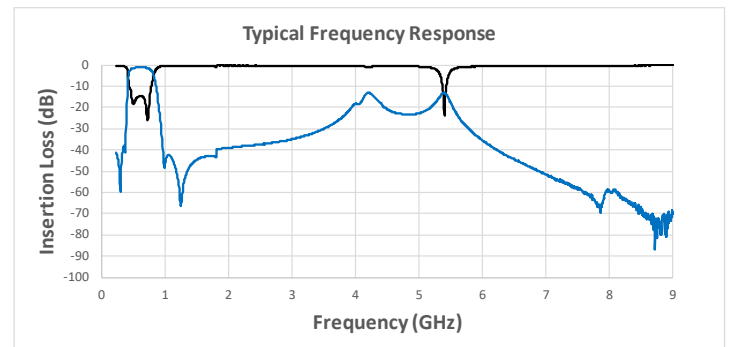
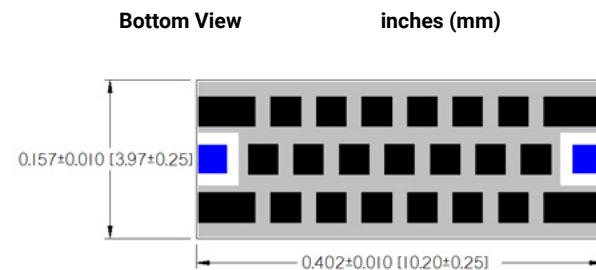

Multilayer Organic (MLO®) Filters

MLO® Band Pass Filters

BP0DA0595A7**

ELECTRICAL SPECIFICATIONS

	Min (GHz)	Max (GHz)		
Pass Band	0.595		1.3	dB Fc Typ
	0.467	0.756	5.0	dB Max
	0.467	0.756	1.9	dB Typ
	0.478	0.745	1.5	dB Ripple
Rejection	DC	0.365	30	dB Min
	1.002	3.000	30	dB Min
Dimension	Thickness		40	Mils Max
RF Power	Power		1	Watts Max

[Click here to return to main table.](#)



CLICK HERE TO DOWNLOAD DATA FILES

*Data files contain DXF and S2P files

DIMENSIONS – CASE SIZE D

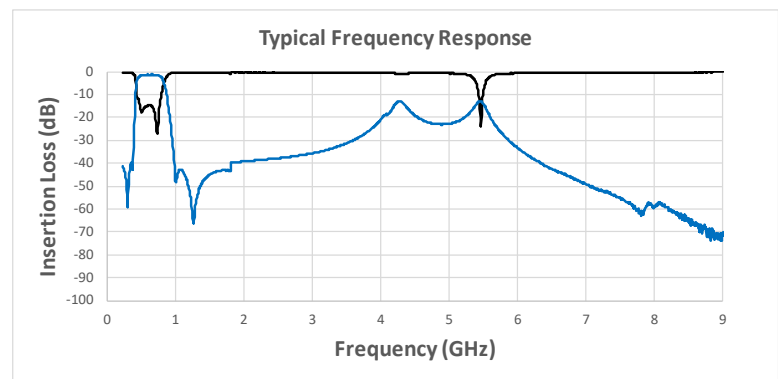
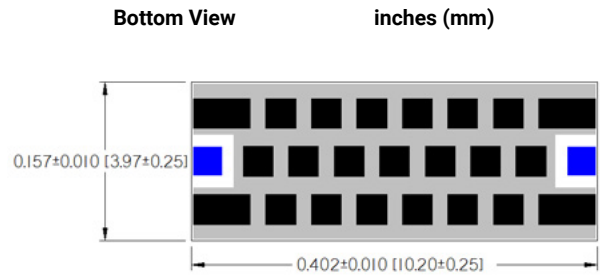

BP0DA0650A7**

ELECTRICAL SPECIFICATIONS

	Min (GHz)	Max (GHz)		
Pass Band	0.650		1.3	dB Fc Typ
	0.490	0.787	5.0	dB Max
	0.490	0.787	2	dB Typ
	0.485	0.776	1.5	dB Ripple
Rejection	DC	0.374	30	dB Min
	1.030	3.000	30	dB Min
Dimension	Thickness		40	Mils Max
RF Power	Power		1	Watts Max

[Click here to return to main table.](#)



CLICK HERE TO DOWNLOAD DATA FILES

*Data files contain DXF and S2P files

DIMENSIONS – CASE SIZE D

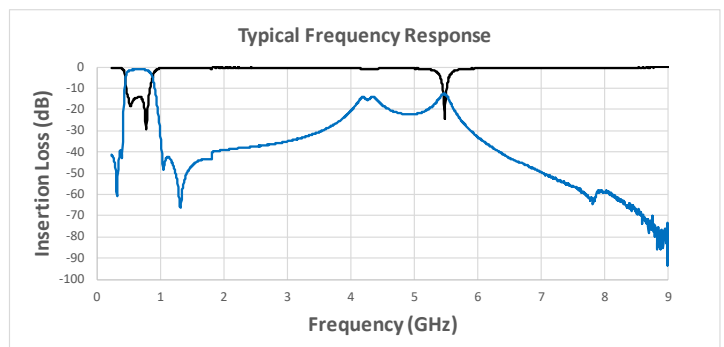
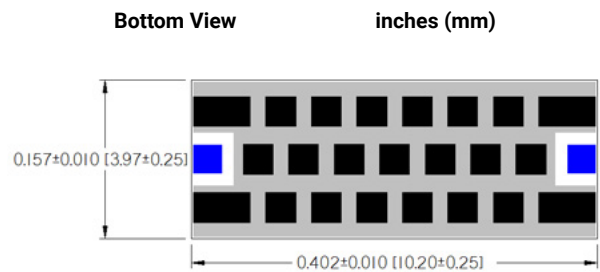

Multilayer Organic (MLO®) Filters

MLO® Band Pass Filters

BPOCA0770A7**

ELECTRICAL SPECIFICATIONS

	Min (GHz)	Max (GHz)		
Pass Band	0.770		0.97	dB Fc Typ
	0.620	0.970	5.0	dB Max
	0.620	0.970	1.97	dB Typ
	0.628	0.954	1.5	dB Ripple
Rejection	DC	0.480	30	dB Min
	1.190	4.500	30	dB Min
	DC	0.460	40	dB Min
	1.230	4.000	40	dB Min
Dimension	Thickness		22	Mils Max
RF Power	Power		1	Watts Max

[Click here to return to main table.](#)



CLICK HERE TO DOWNLOAD DATA FILES

*Data files contain DXF and S2P files

DIMENSIONS – CASE SIZE C

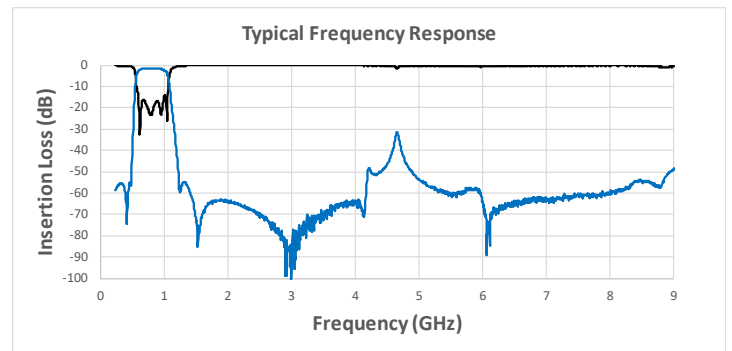
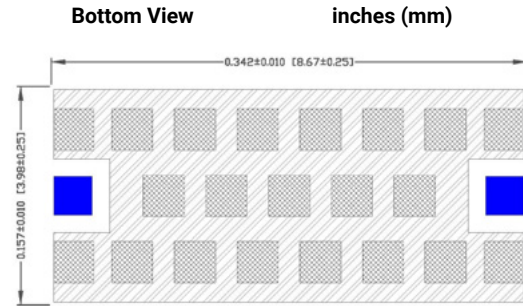

BPOCA0810A7**

ELECTRICAL SPECIFICATIONS

	Min (GHz)	Max (GHz)		
Pass Band	0.810		1.3	dB Fc Typ
	0.657	1.006	5.0	dB Max
	0.657	1.006	2	dB Typ
	0.668	0.985	1.5	dB Ripple
Rejection	DC	0.511	30	dB Min
	1.256	4.000	30	dB Min
	DC	0.500	40	dB Min
	1.290	4.000	40	dB Min
Dimension	Thickness		40	Mils Max
RF Power	Power		1	Watts Max

[Click here to return to main table.](#)



CLICK HERE TO DOWNLOAD DATA FILES

*Data files contain DXF and S2P files

DIMENSIONS – CASE SIZE C

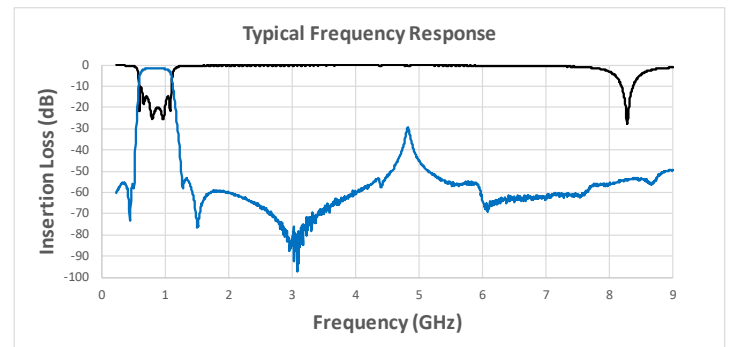
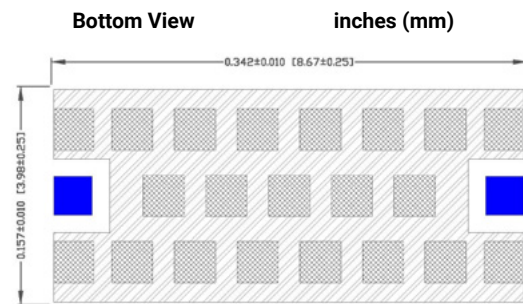

Multilayer Organic (MLO®) Filters

MLO® Band Pass Filters

BP0CA0825A7**

ELECTRICAL SPECIFICATIONS

	Min (GHz)	Max (GHz)		
Pass Band	0.825		1.3	dB Fc Typ
	0.668	1.021	5.0	dB Max
	0.668	1.021	2	dB Typ
	0.680	0.985	1.5	dB Ripple
Rejection	DC	0.513	30	dB Min
	1.261	4.000	30	dB Min
	DC	0.504	40	dB Min
Dimension	Thickness		40	Mils Max
	RF Power		Power	1 Watts Max

[Click here to return to main table.](#)

CLICK HERE TO DOWNLOAD DATA FILES

*Data files contain DXF and S2P files

DIMENSIONS – CASE SIZE C

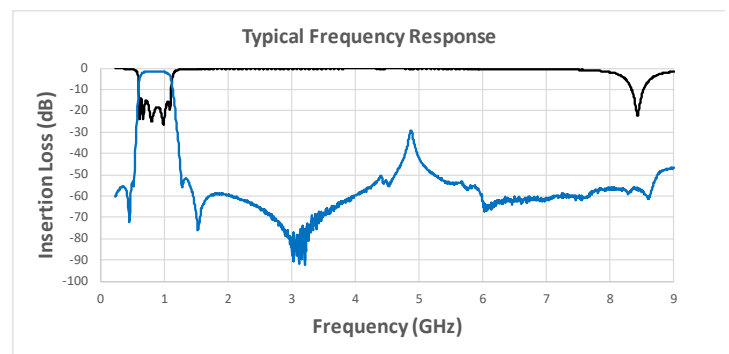
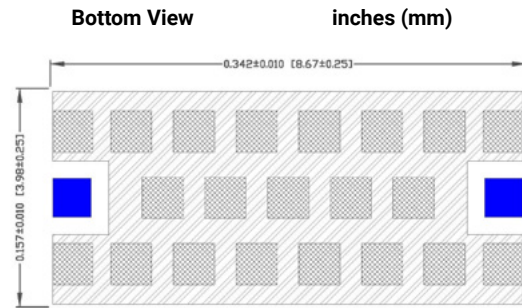

BP0CA0855A7**

ELECTRICAL SPECIFICATIONS

	Min (GHz)	Max (GHz)		
Pass Band	0.855		1.4	dB Fc Typ
	0.691	1.053	5.0	dB Max
	0.691	1.053	2	dB Typ
	0.708	1.032	1.5	dB Ripple
Rejection	DC	0.542	30	dB Min
	1.314	4.000	30	dB Min
	DC	0.526	40	dB Min
Dimension	Thickness		40	Mils Max
	RF Power		Power	1 Watts Max

[Click here to return to main table.](#)

CLICK HERE TO DOWNLOAD DATA FILES

*Data files contain DXF and S2P files

DIMENSIONS – CASE SIZE C

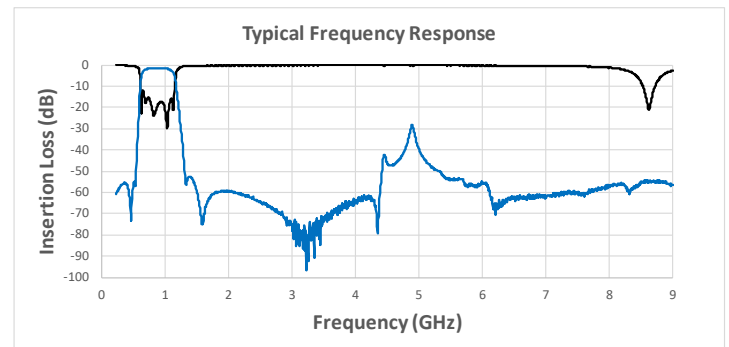
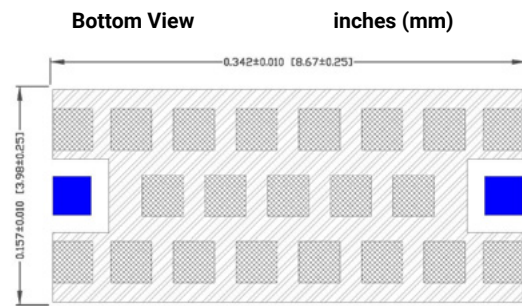

Multilayer Organic (MLO®) Filters

MLO® Band Pass Filters

BP0CA1070A7**

ELECTRICAL SPECIFICATIONS

	Min (GHz)	Max (GHz)		
Pass Band	1.070		1.1	dB Fc Typ
	0.864	1.329	5.0	dB Max
	0.864	1.329	2.1	dB Typ
	0.887	1.313	1.5	dB Ripple
Rejection	DC	0.693	30	dB Min
	1.647	4.000	30	dB Min
	DC	0.672	40	dB Min
Dimension	Thickness		40	Mils Max
RF Power	Power		1	Watts Max

[Click here to return to main table.](#)



CLICK HERE TO DOWNLOAD DATA FILES

*Data files contain DXF and S2P files

DIMENSIONS – CASE SIZE C

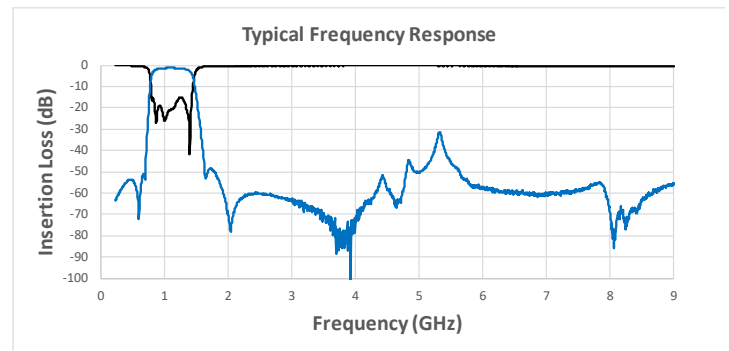
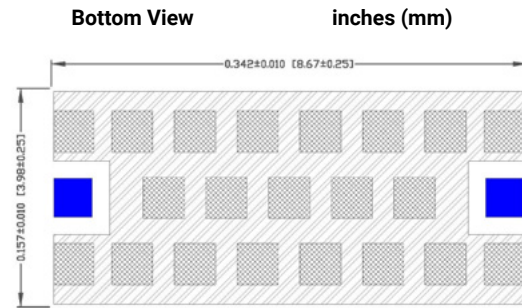

BP0CA1090A7**

ELECTRICAL SPECIFICATIONS

	Min (GHz)	Max (GHz)		
Pass Band	1.090		1.3	dB Fc Typ
	0.881	1.350	5.0	dB Max
	0.881	1.350	2.1	dB Typ
	0.898	1.329	1.5	dB Ripple
Rejection	DC	0.698	30	dB Min
	1.676	4.500	30	dB Min
	DC	0.683	40	dB Min
Dimension	Thickness		40	Mils Max
RF Power	Power		1	Watts Max

[Click here to return to main table.](#)



CLICK HERE TO DOWNLOAD DATA FILES

*Data files contain DXF and S2P files

DIMENSIONS – CASE SIZE C

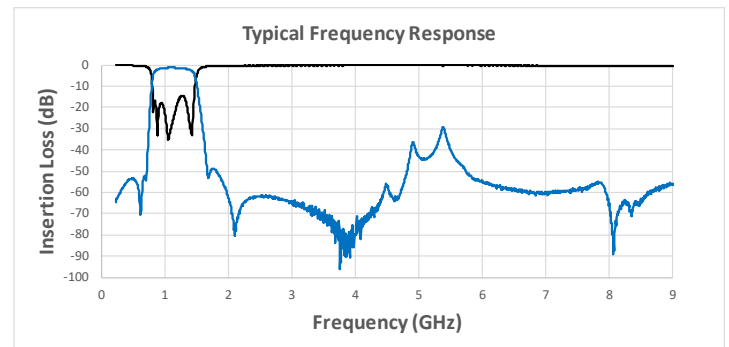
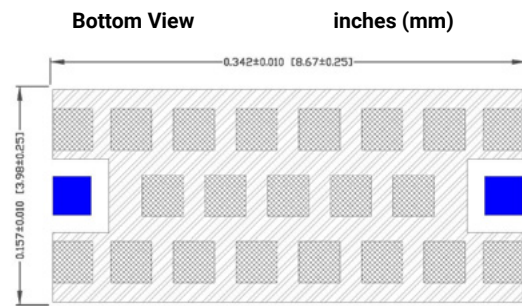

Multilayer Organic (MLO®) Filters

MLO® Band Pass Filters

BP0CA1100A7**

ELECTRICAL SPECIFICATIONS

	Min (GHz)	Max (GHz)		
Pass Band	1.100		0.95	dB Fc Typ
	0.860	1.390	5.0	dB Max
	0.860	1.390	1.62	dB Typ
	0.881	1.365	1.5	dB Ripple
Rejection	DC	0.680	30	dB Min
	1.680	5.000	30	dB Min
	DC	0.660	40	dB Min
	1.730	4.500	40	dB Min
Dimension	Thickness		22	Mils Max
RF Power	Power		1	Watts Max

[Click here to return to main table.](#)



CLICK HERE TO DOWNLOAD DATA FILES

*Data files contain DXF and S2P files

DIMENSIONS – CASE SIZE C

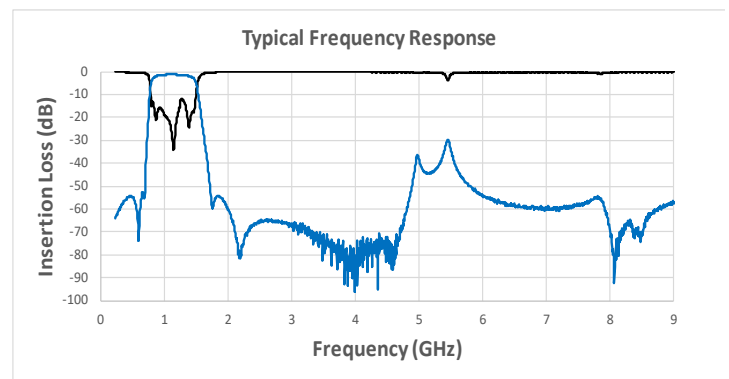
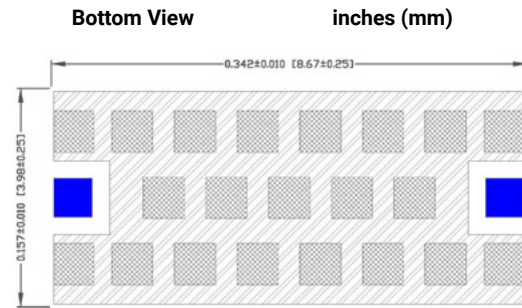

BP0FA1100A7**

ELECTRICAL SPECIFICATIONS

	Min (GHz)	Max (GHz)		
Pass Band	1.100		1.19	dB Fc Typ
	0.870	1.390	5.0	dB Max
	0.870	1.390	1.97	dB Typ
	0.915	1.340	1.5	dB Ripple
Rejection	DC	0.670	30	dB Min
	1.720	16.700	30	dB Min
	DC	0.640	40	dB Min
	1.780	11.110	40	dB Min
Dimension	Thickness		22	Mils Max
RF Power	Power		1	Watts Max

[Click here to return to main table.](#)



CLICK HERE TO DOWNLOAD DATA FILES

*Data files contain DXF and S2P files

DIMENSIONS – CASE SIZE F

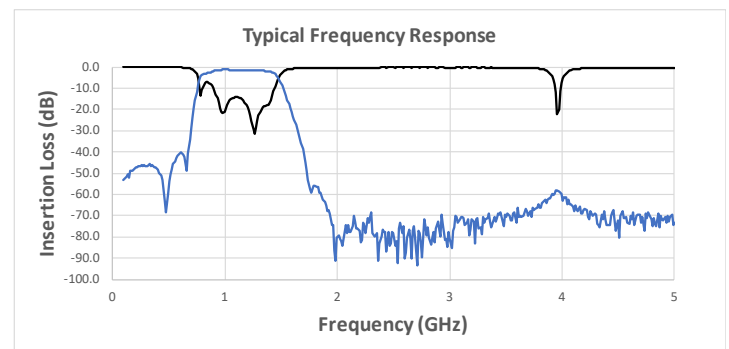
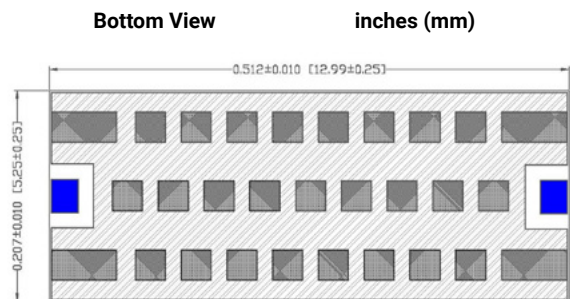

Multilayer Organic (MLO®) Filters

MLO® Band Pass Filters

BP0FA1130A7**

ELECTRICAL SPECIFICATIONS

	Min (GHz)	Max (GHz)		
Pass Band	1.130		1.35	dB Fc Typ
	0.890	1.440	5.0	dB Max
	0.890	1.440	2.18	dB Typ
	0.928	1.398	1.5	dB Ripple
Rejection	DC	0.680	30	dB Min
	1.760	15.540	30	dB Min
	DC	0.660	40	dB Min
	1.790	11.700	40	dB Min
Dimension	Thickness		22	Mils Max
RF Power	Power		1	Watts Max

[Click here to return to main table.](#)



CLICK HERE TO DOWNLOAD DATA FILES

*Data files contain DXF and S2P files

DIMENSIONS – CASE SIZE F

Bottom View

inches (mm)

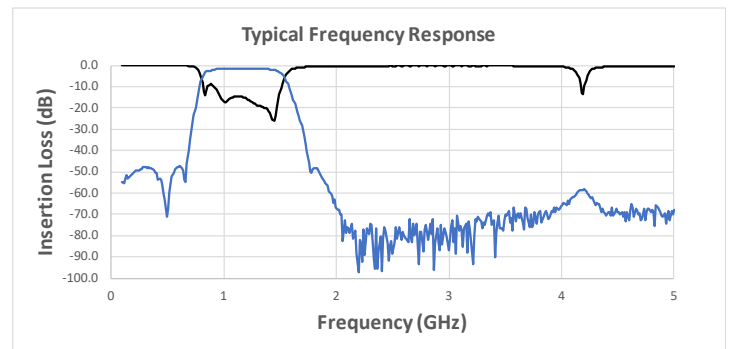
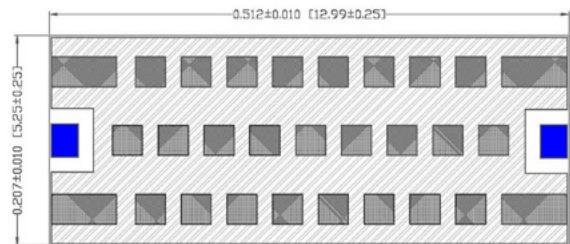

BP0CA1160A7**

ELECTRICAL SPECIFICATIONS

	Min (GHz)	Max (GHz)		
Pass Band	1.160		1.3	dB Fc Typ
	0.910	1.397	5.0	dB Max
	0.910	1.397	2	dB Typ
	0.943	1.340	1.5	dB Ripple
Rejection	DC	0.719	30	dB Min
	1.727	4.750	30	dB Min
	DC	0.704	40	dB Min
	1.820	4.275	40	dB Min
Dimension	Thickness		40	Mils Max
RF Power	Power		1	Watts Max

[Click here to return to main table.](#)



CLICK HERE TO DOWNLOAD DATA FILES

*Data files contain DXF and S2P files

DIMENSIONS – CASE SIZE C

Bottom View

inches (mm)

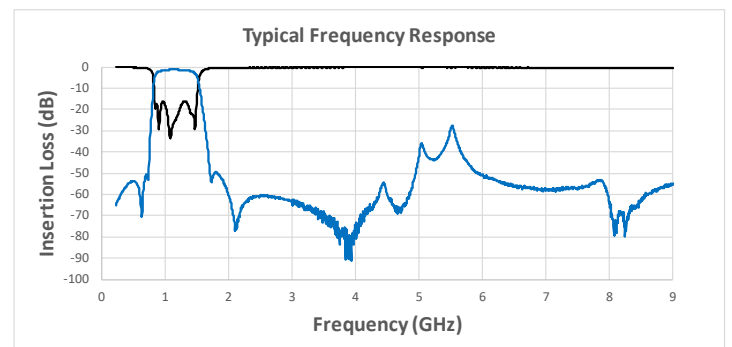
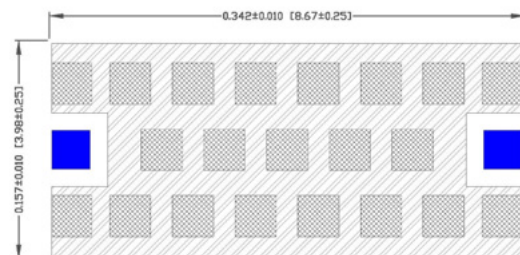

Multilayer Organic (MLO®) Filters

MLO® Band Pass Filters

BP0FA1190A7**

ELECTRICAL SPECIFICATIONS

	Min (GHz)	Max (GHz)		
Pass Band	1.190		1.28	dB Fc Typ
	0.990	1.440	5.0	dB Max
	0.990	1.440	1.96	dB Typ
	1.031	1.387	1.5	dB Ripple
Rejection	DC	0.760	30	dB Min
	1.740	18.000	30	dB Min
	DC	0.740	40	dB Min
	1.780	16.290	40	dB Min
Dimension	Thickness		22	Mils Max
RF Power	Power		1	Watts Max

[Click here to return to main table.](#)



CLICK HERE TO DOWNLOAD DATA FILES

*Data files contain DXF and S2P files

DIMENSIONS – CASE SIZE F

Bottom View

inches (mm)

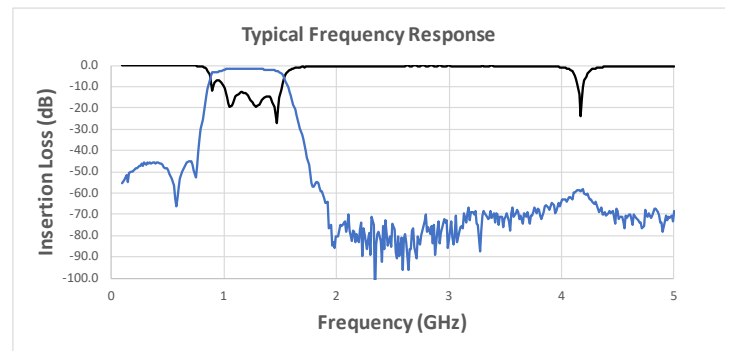
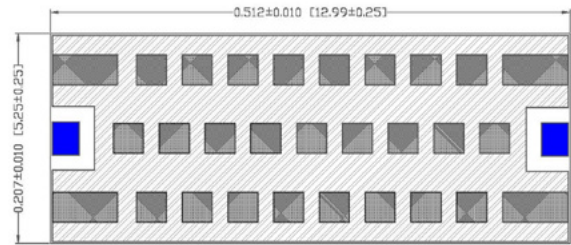

BP0CA1610A7**

ELECTRICAL SPECIFICATIONS

	Min (GHz)	Max (GHz)		
Pass Band	1.610		0.89	dB Fc Typ
	1.270	2.050	5.0	dB Max
	1.270	2.050	1.74	dB Typ
	1.290	2.006	1.5	dB Ripple
Rejection	DC	1.040	30	dB Min
	2.500	9.000	30	dB Min
	DC	1.020	40	dB Min
	2.570	6.260	40	dB Min
Dimension	Thickness		22	Mils Max
RF Power	Power		1	Watts Max

[Click here to return to main table.](#)



CLICK HERE TO DOWNLOAD DATA FILES

*Data files contain DXF and S2P files

DIMENSIONS – CASE SIZE C

Bottom View

inches (mm)

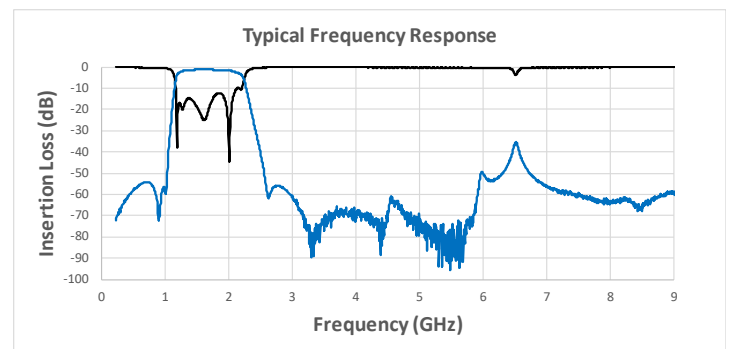
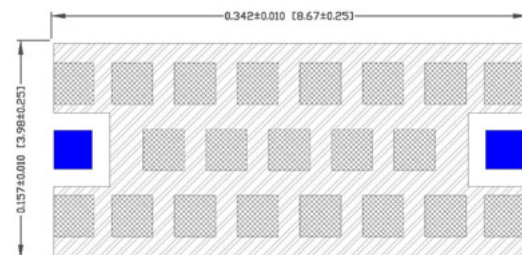

Multilayer Organic (MLO®) Filters

MLO® Band Pass Filters

BP0EA1950A7**

ELECTRICAL SPECIFICATIONS

	Min (GHz)	Max (GHz)		
Pass Band	1.950		0.94	dB Fc Typ
	1.440	2.640	5.0	dB Max
	1.440	2.640	1.46	dB Typ
	1.486	2.573	1.5	dB Ripple
Rejection	DC	1.190	30	dB Min
	3.140	9.000	30	dB Min
	DC	1.160	40	dB Min
	3.220	7.500	40	dB Min
Dimension	Thickness		22	Mils Max
RF Power	Power		1	Watts Max

[Click here to return to main table.](#)



CLICK HERE TO DOWNLOAD DATA FILES

*Data files contain DXF and S2P files

DIMENSIONS – CASE SIZE E

Bottom View

inches (mm)

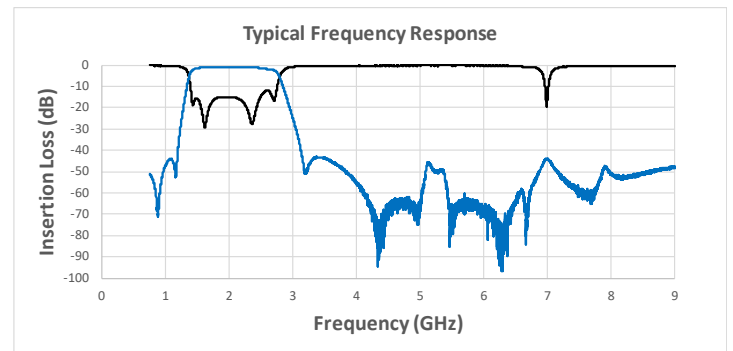
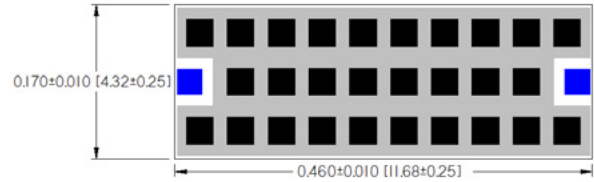

BP0EA1980A7**

ELECTRICAL SPECIFICATIONS

	Min (GHz)	Max (GHz)		
Pass Band	1.980		0.98	dB Fc Typ
	1.470	2.680	5.0	dB Max
	1.470	2.680	1.43	dB Typ
	1.506	2.629	1.5	dB Ripple
Rejection	DC	1.210	30	dB Min
	3.270	9.000	30	dB Min
	DC	1.170	40	dB Min
	3.370	7.620	40	dB Min
Dimension	Thickness		22	Mils Max
RF Power	Power		1	Watts Max

[Click here to return to main table.](#)



CLICK HERE TO DOWNLOAD DATA FILES

*Data files contain DXF and S2P files

DIMENSIONS – CASE SIZE E

Bottom View

inches (mm)

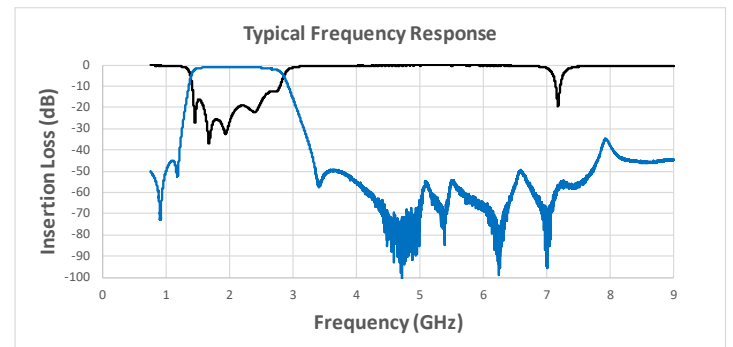
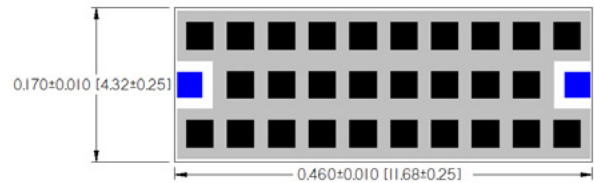

Multilayer Organic (MLO®) Filters

MLO® Band Pass Filters

BP0EA2000A7**

ELECTRICAL SPECIFICATIONS

	Min (GHz)	Max (GHz)		
Pass Band	2.000		1.8	dB Fc Typ
	1.838	2.180	5.0	dB Max
	1.838	2.180	2.2	dB Typ
	1.878	2.121	1.5	dB Ripple
Rejection	DC	1.480	30	dB Min
	2.675	9.000	30	dB Min
	DC	1.454	40	dB Min
	2.729	8.000	40	dB Min
Dimensions	Thickness		22	Mils Max
RF Power	Power		1	Watts Max

[Click here to return to main table.](#)

DIMENSIONS – CASE SIZE E

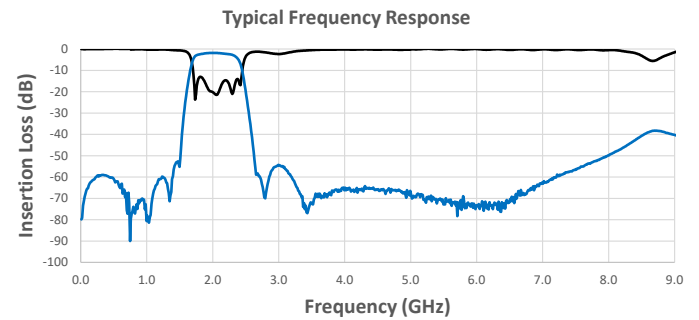
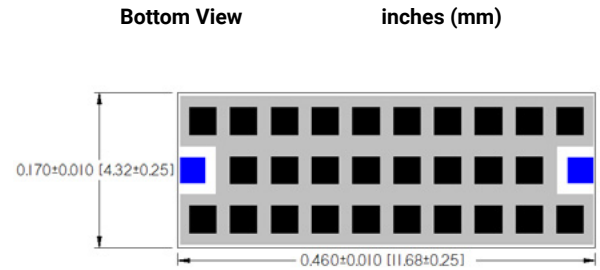

*Data files contain DXF and S2P files

BP0EA2055A7**

ELECTRICAL SPECIFICATIONS

	Min (GHz)	Max (GHz)		
Pass Band	2.055		1.8	dB Fc Typ
	1.902	2.223	5.0	dB Max
	1.902	2.223	2.1	dB Typ
	1.944	2.180	1.5	dB Ripple
Rejection	DC	1.518	30	dB Min
	2.770	9.000	30	dB Min
	DC	1.492	40	dB Min
	2.817	8.000	40	dB Min
Dimensions	Thickness		22	Mils Max
RF Power	Power		1	Watts Max

[Click here to return to main table.](#)

DIMENSIONS – CASE SIZE E

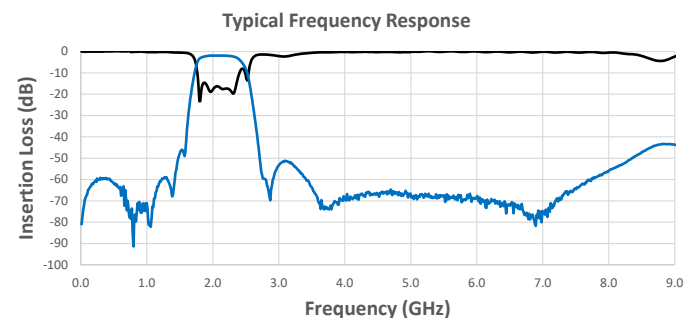
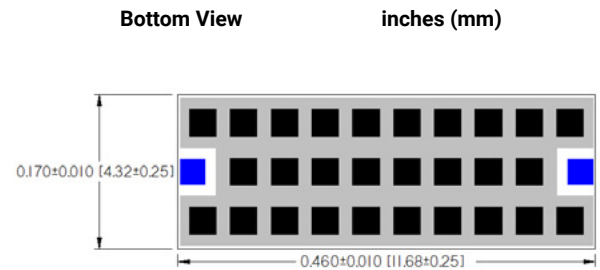

CLICK HERE TO DOWNLOAD DATA FILES

*Data files contain DXF and S2P files

Multilayer Organic (MLO®) Filters

MLO® Band Pass Filters

BP0EA2090A7**

ELECTRICAL SPECIFICATIONS

	Min (GHz)	Max (GHz)		
Pass Band	2.090		1.08	dB Fc Typ
	1.450	2.840	5.0	dB Max
	1.450	2.840	1.33	dB Typ
	1.580	2.759	1.5	dB Ripple
Rejection	DC	1.280	30	dB Min
	3.400	9.000	30	dB Min
	DC	1.230	40	dB Min
	3.600	7.920	40	dB Min
Dimension	Thickness		22	Mils Max
RF Power	Power		1	Watts Max

[Click here to return to main table.](#)

CLICK HERE TO DOWNLOAD DATA FILES

*Data files contain DXF and S2P files

DIMENSIONS – CASE SIZE E

Bottom View

inches (mm)

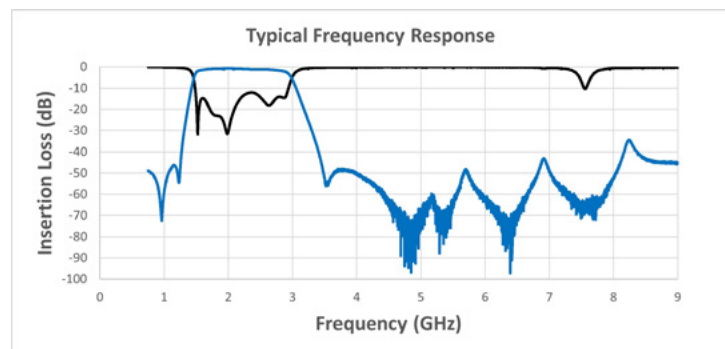
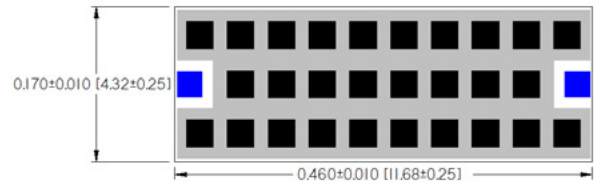

BP0EA2135A7**

ELECTRICAL SPECIFICATIONS

	Min (GHz)	Max (GHz)		
Pass Band	2.135		1.8	dB Fc Typ
	1.961	2.325	5.0	dB Max
	1.961	2.325	2.2	dB Typ
	2.002	2.266	1.5	dB Ripple
Rejection	DC	1.561	30	dB Min
	2.841	9.000	30	dB Min
	DC	1.529	40	dB Min
	2.882	8.000	40	dB Min
Dimensions	Thickness		22	Mils Max
RF Power	Power		1	Watts Max

[Click here to return to main table.](#)

CLICK HERE TO DOWNLOAD DATA FILES

*Data files contain DXF and S2P files

DIMENSIONS – CASE SIZE E

Bottom View

inches (mm)

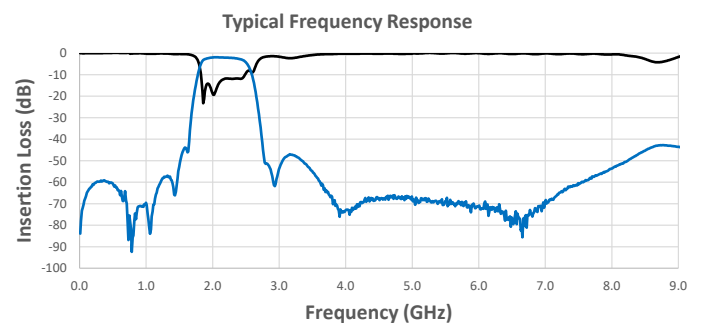
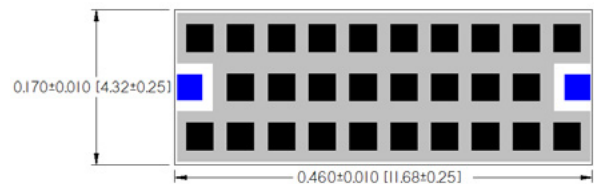

Multilayer Organic (MLO®) Filters

MLO® Band Pass Filters



BP0BA2150A7**

ELECTRICAL SPECIFICATIONS

	Min (GHz)	Max (GHz)		
Pass Band	2.150		1.4	dB Fc Typ
	1.750	2.579	5.0	dB Max
	1.750	2.579	1.8	dB Typ
	1.768	2.548	1.5	dB Ripple
Rejection	DC	1.344	30	dB Min
	3.305	9.000	30	dB Min
Dimensions	Thickness		40	Mils Max
RF Power	Power		1	Watts Max

Click here to return to main table.



CLICK HERE TO DOWNLOAD DATA FILES

*Data files contain DXF and S2P files

DIMENSIONS – CASE SIZE B

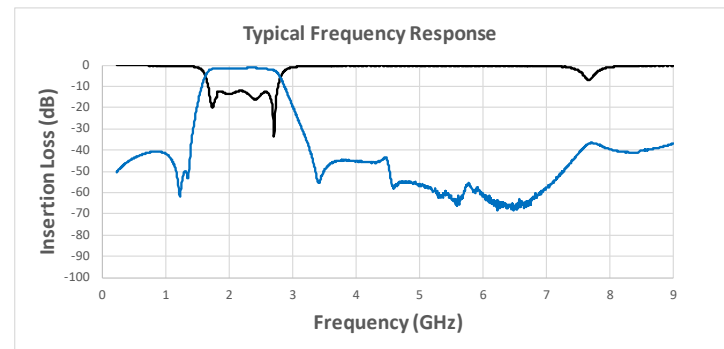
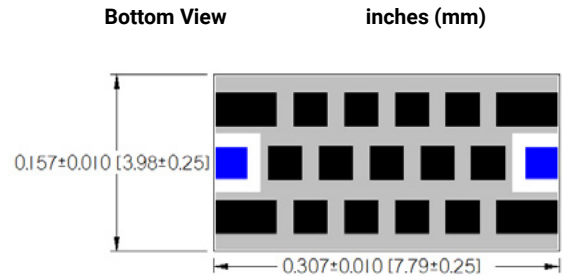

BP0BA2260A7**

ELECTRICAL SPECIFICATIONS

	Min (GHz)	Max (GHz)		
Pass Band	2.260		1.3	dB Fc Typ
	1.820	2.673	5.0	dB Max
	1.820	2.673	1.9	dB Typ
	1.838	2.642	1.5	dB Ripple
Rejection	DC	1.397	30	dB Min
	3.444	9.000	30	dB Min
Dimension	Thickness		40	Mils Max
RF Power	Power		1	Watts Max

Click here to return to main table.



CLICK HERE TO DOWNLOAD DATA FILES

*Data files contain DXF and S2P files

DIMENSIONS – CASE SIZE B

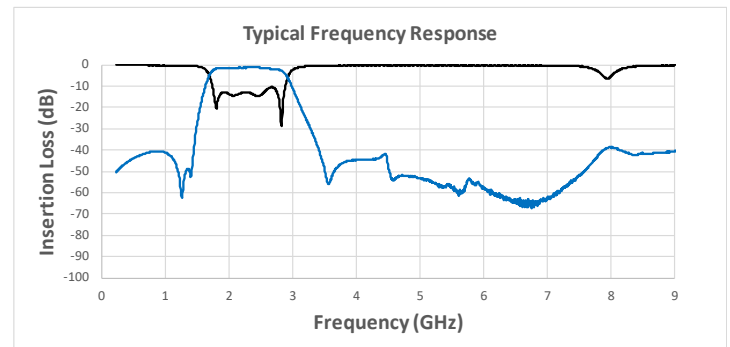
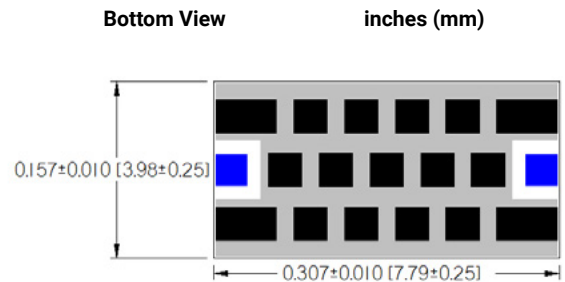

Multilayer Organic (MLO®) Filters

MLO® Band Pass Filters

BP0BA2290A7**

ELECTRICAL SPECIFICATIONS

	Min (GHz)	Max (GHz)		
Pass Band	2.290		1.2	dB Fc Typ
	1.866	2.715	5.0	dB Max
	1.866	2.715	1.8	dB Typ
	1.884	2.751	1.5	dB Ripple
Rejection	DC	1.433	30	dB Min
	3.548	9.000	30	dB Min
Dimension	Thickness		40	Mils Max
RF Power	Power		1	Watts Max

[Click here to return to main table.](#)



CLICK HERE TO DOWNLOAD DATA FILES

*Data files contain DXF and S2P files

DIMENSIONS – CASE SIZE B

Bottom View

inches (mm)

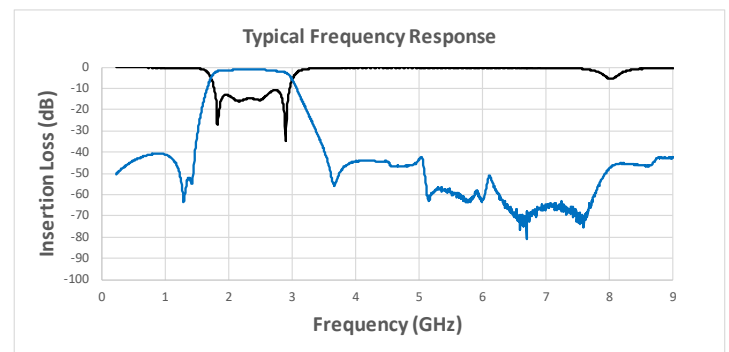
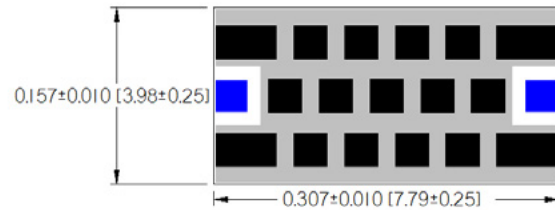

BP0EA2423A7**

ELECTRICAL SPECIFICATIONS

	Min (GHz)	Max (GHz)		
Pass Band	2.423		1.6	dB Fc Typ
	2.138	2.746	5.0	dB Max
	2.138	2.746	2.3	dB Typ
	2.168	2.646	1.5	dB Ripple
Rejection	DC	1.758	30	dB Min
	3.290	9.000	30	dB Min
	DC	1.732	40	dB Min
Dimensions	Thickness		22	Mils Max
	Power		1	Watts Max

[Click here to return to main table.](#)



CLICK HERE TO DOWNLOAD DATA FILES

*Data files contain DXF and S2P files

DIMENSIONS – CASE SIZE E

Bottom View

inches (mm)

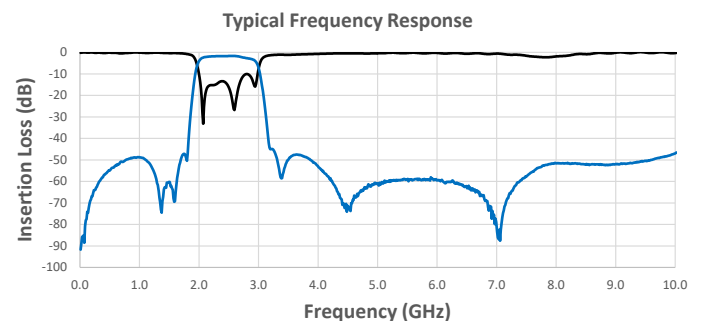
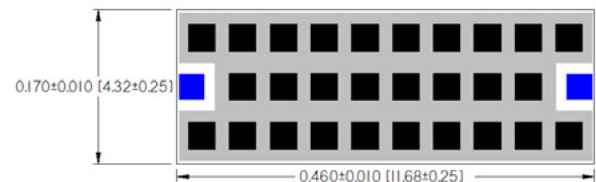

Multilayer Organic (MLO®) Filters

MLO® Band Pass Filters

BP0EA2500A7**

ELECTRICAL SPECIFICATIONS

	Min (GHz)	Max (GHz)		
Pass Band	2.500		1.36	dB Fc Typ
	2.020	3.210	5.0	dB Max
	2.020	3.210	2.38	dB Typ
	2.084	3.003	1.5	dB Ripple
Rejection	DC	1.690	30	dB Min
	3.710	9.000	30	dB Min
	DC	1.640	40	dB Min
	3.800	7.500	40	dB Min
Dimension	Thickness		22	Mils Max
RF Power	Power		1	Watts Max

[Click here to return to main table.](#)



CLICK HERE TO DOWNLOAD DATA FILES

*Data files contain DXF and S2P files

DIMENSIONS – CASE SIZE E

Bottom View inches (mm)

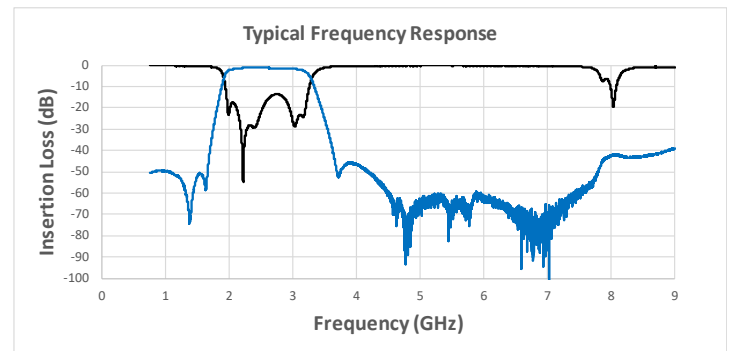
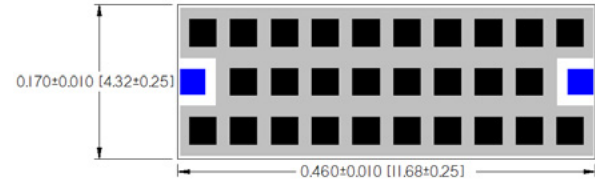

BP0EA2510A7**

ELECTRICAL SPECIFICATIONS

	Min (GHz)	Max (GHz)		
Pass Band	2.510		1.6	dB Fc Typ
	2.209	2.832	5.0	dB Max
	2.209	2.832	2.1	dB Typ
	2.245	2.774	1.5	dB Ripple
Rejection	DC	1.822	30	dB Min
	3.366	9.000	30	dB Min
	DC	1.796	40	dB Min
	3.402	9.000	40	dB Min
Dimensions	Thickness		22	Mils Max
RF Power	Power		1	Watts Max

[Click here to return to main table.](#)



CLICK HERE TO DOWNLOAD DATA FILES

*Data files contain DXF and S2P files

DIMENSIONS – CASE SIZE E

Bottom View inches (mm)

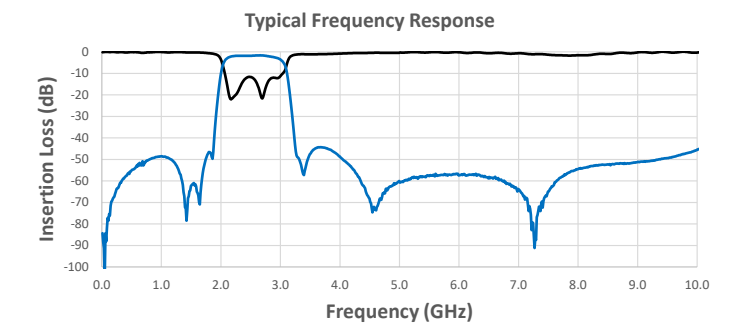
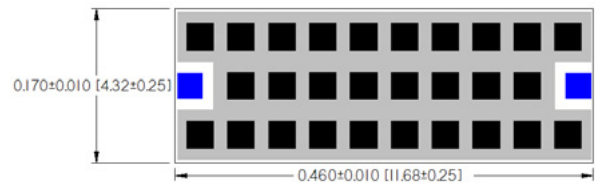

Multilayer Organic (MLO®) Filters

MLO® Band Pass Filters

BP0EA2540A7**

ELECTRICAL SPECIFICATIONS

	Min (GHz)	Max (GHz)		
Pass Band	2.540		1.11	dB Fc Typ
	2.020	3.210	5.0	dB Max
	2.020	3.210	1.88	dB Typ
	2.077	3.161	1.5	dB Ripple
Rejection	DC	1.700	30	dB Min
	3.800	8.300	30	dB Min
	DC	1.640	40	dB Min
	3.900	7.800	40	dB Min
Dimension	Thickness		22	Mils Max
RF Power	Power		1	Watts Max

[Click here to return to main table.](#)



CLICK HERE TO DOWNLOAD DATA FILES

*Data files contain DXF and S2P files

DIMENSIONS – CASE SIZE E

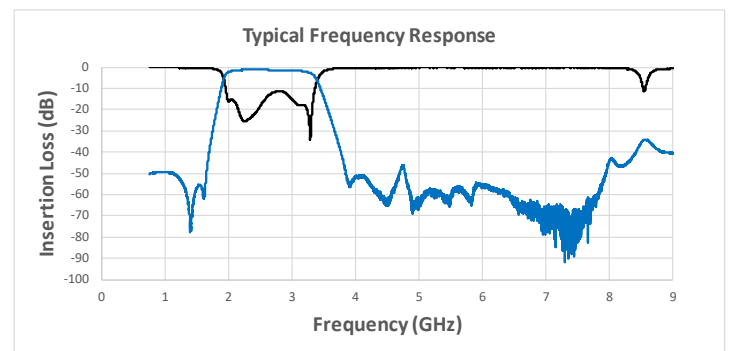
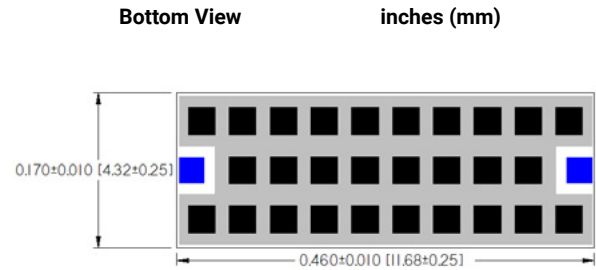

BP0EA2568A7**

ELECTRICAL SPECIFICATIONS

	Min (GHz)	Max (GHz)		
Pass Band	2.568		1.9	dB Fc Typ
	2.256	2.923	5.0	dB Max
	2.256	2.923	2.1	dB Typ
	2.286	2.864	1.5	dB Ripple
Rejection	DC	1.871	30	dB Min
	3.485	10.000	30	dB Min
	DC	1.844	40	dB Min
	3.521	9.000	40	dB Min
Dimensions	Thickness		22	Mils Max
RF Power	Power		1	Watts Max

[Click here to return to main table.](#)



CLICK HERE TO DOWNLOAD DATA FILES

*Data files contain DXF and S2P files

DIMENSIONS – CASE SIZE E

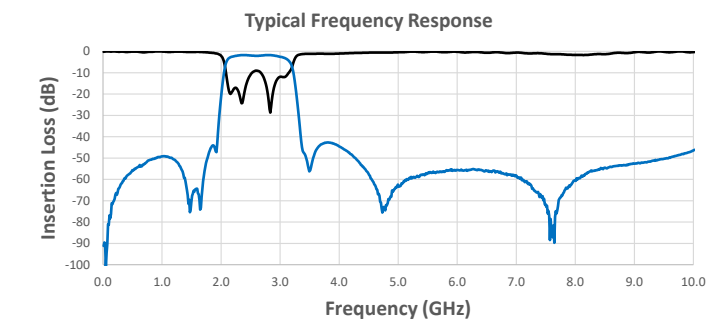
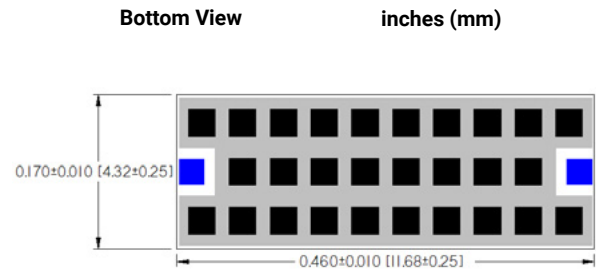

Multilayer Organic (MLO®) Filters

MLO® Band Pass Filters

BP0EA2620A7**

ELECTRICAL SPECIFICATIONS

	Min (GHz)	Max (GHz)		
Pass Band	2.620		1.55	dB Fc Typ
	2.090	3.280	5.0	dB Max
	2.090	3.280	2.21	dB Typ
	2.141	3.169	1.5	dB Ripple
Rejection	DC	1.740	30	dB Min
	3.910	7.800	30	dB Min
	DC	1.680	40	dB Min
	3.960	7.700	40	dB Min
Dimension	Thickness		22	Mils Max
RF Power	Power		1	Watts Max

[Click here to return to main table.](#)

CLICK HERE TO DOWNLOAD DATA FILES

*Data files contain DXF and S2P files

DIMENSIONS – CASE SIZE E

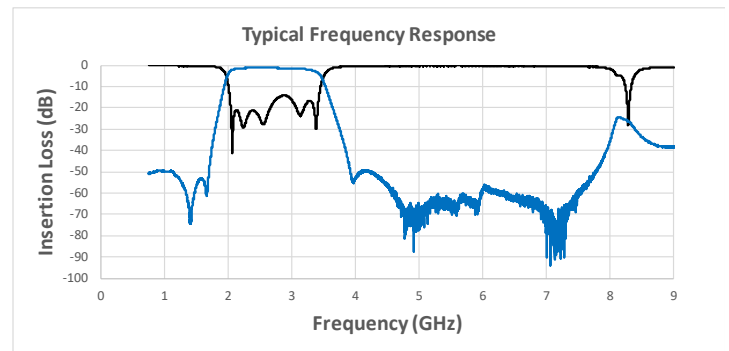
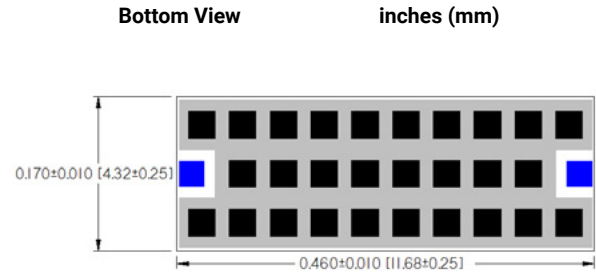

BP0EA3060A7**

ELECTRICAL SPECIFICATIONS

	Min (GHz)	Max (GHz)		
Pass Band	3.060		1.6	dB Fc Typ
	2.741	3.420	5.0	dB Max
	2.741	3.420	2.1	dB Typ
	2.783	3.340	1.5	dB Ripple
Rejection	DC	2.261	30	dB Min
	4.099	11.000	30	dB Min
	DC	2.223	40	dB Min
	4.140	10.200	40	dB Min
Dimensions	Thickness		22	Mils Max
RF Power	Power		1	Watts Max

[Click here to return to main table.](#)

CLICK HERE TO DOWNLOAD DATA FILES

*Data files contain DXF and S2P files

DIMENSIONS – CASE SIZE E

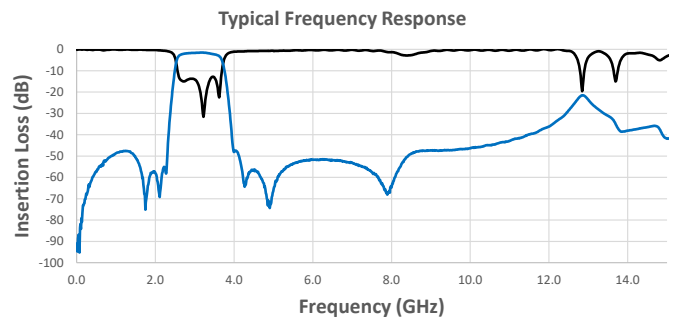
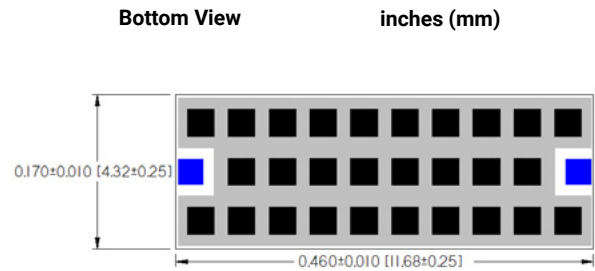

Multilayer Organic (MLO®) Filters

MLO® Band Pass Filters

BP0EA3123A7**

ELECTRICAL SPECIFICATIONS

	Min (GHz)	Max (GHz)		
Pass Band	3.123		1.5	dB Fc Typ
	2.799	3.485	5.0	dB Max
	2.799	3.485	2.2	dB Typ
	2.847	3.430	1.5	dB Ripple
Rejection	DC	2.319	30	dB Min
	4.153	12.000	30	dB Min
	DC	2.288	40	dB Min
	4.200	9.000	40	dB Min
Dimensions	Thickness		22	Mils Max
RF Power	Power		1	Watts Max

[Click here to return to main table.](#)



CLICK HERE TO DOWNLOAD DATA FILES

*Data files contain DXF and S2P files

DIMENSIONS – CASE SIZE E

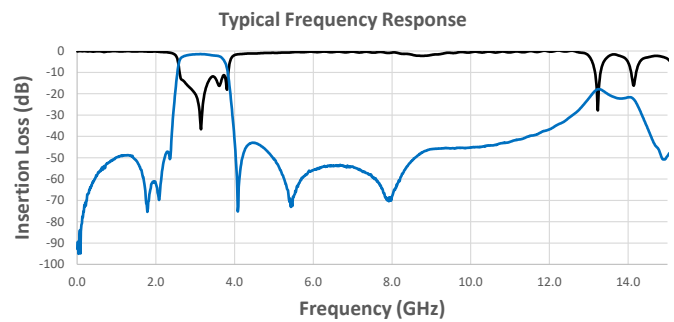
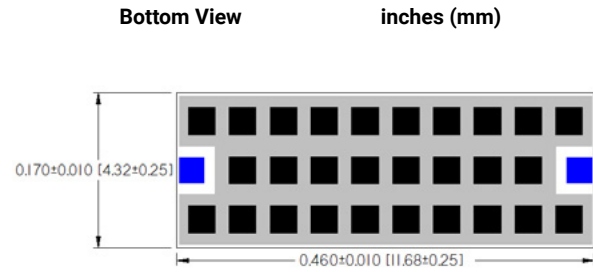

BP0EA3180A7**

ELECTRICAL SPECIFICATIONS

	Min (GHz)	Max (GHz)		
Pass Band	3.180		0.84	dB Fc Typ
	2.450	4.140	5.0	dB Max
	2.450	4.140	1.67	dB Typ
	2.505	4.016	1.5	dB Ripple
Rejection	DC	1.810	30	dB Min
	5.250	18.430	30	dB Min
	DC	1.750	40	dB Min
	5.460	15.500	40	dB Min
Dimension	Thickness		22	Mils Max
RF Power	Power		1	Watts Max

[Click here to return to main table.](#)



CLICK HERE TO DOWNLOAD DATA FILES

*Data files contain DXF and S2P files

DIMENSIONS – CASE SIZE E

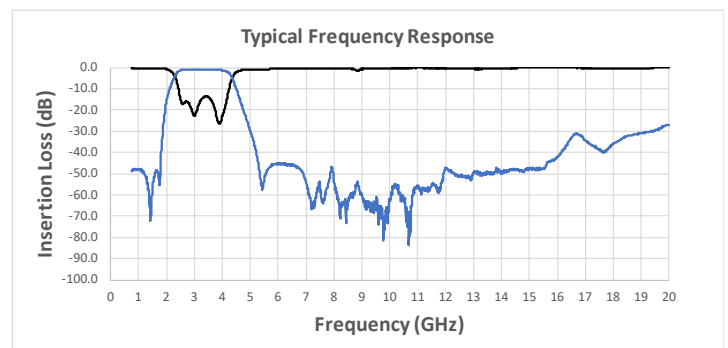
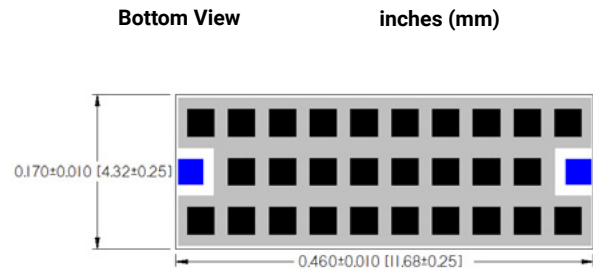

Multilayer Organic (MLO®) Filters

MLO® Band Pass Filters

BP0BA3270A7**

ELECTRICAL SPECIFICATIONS

	Min (GHz)	Max (GHz)		
Pass Band	3.270		2.2	dB Fc Typ
	3.156	3.381	5.0	dB Max
	3.156	3.381	2.3	dB Typ
	3.242	3.314	1.5	dB Ripple
Rejection	DC	2.334	30	dB Min
	4.337	9.000	30	dB Min
	DC	2.219	40	dB Min
Dimension	Thickness		22	Mils Max
	RF Power		Power	1

[Click here to return to main table.](#)



CLICK HERE TO DOWNLOAD DATA FILES

*Data files contain DXF and S2P files

DIMENSIONS – CASE SIZE B

Bottom View

inches (mm)

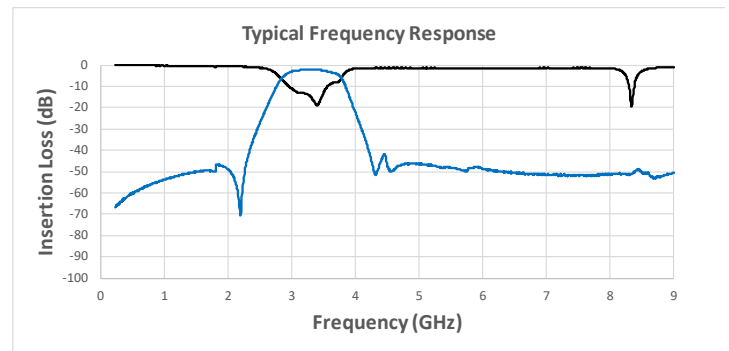
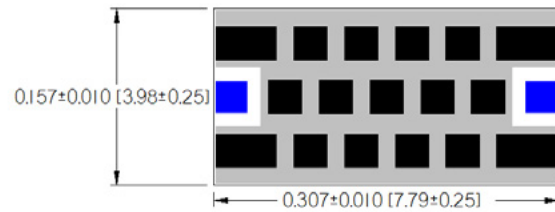

BP0BA3280A7**

ELECTRICAL SPECIFICATIONS

	Min (GHz)	Max (GHz)		
Pass Band	3.280		2.2	dB Fc Typ
	3.150	3.412	5.0	dB Max
	3.150	3.412	2.2	dB Typ
	3.225	3.340	1.5	dB Ripple
Rejection	DC	2.361	30	dB Min
	4.376	9.000	30	dB Min
	DC	2.246	40	dB Min
Dimension	Thickness		22	Mils Max
	RF Power		Power	1

[Click here to return to main table.](#)



CLICK HERE TO DOWNLOAD DATA FILES

*Data files contain DXF and S2P files

DIMENSIONS – CASE SIZE B

Bottom View

inches (mm)

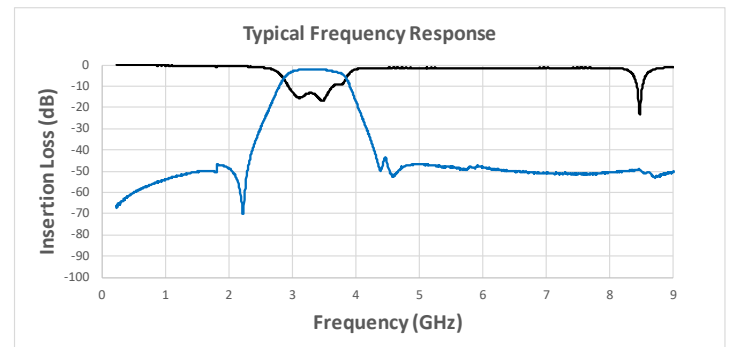
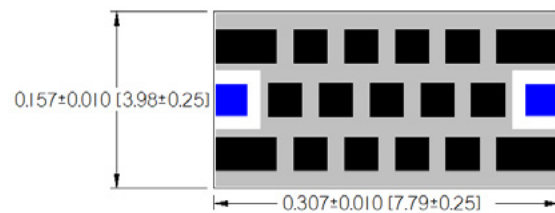

Multilayer Organic (MLO®) Filters

MLO® Band Pass Filters

BP0EA3284A7**

ELECTRICAL SPECIFICATIONS

	Min (GHz)	Max (GHz)		
Pass Band	3.284		1.5	dB Fc Typ
	2.972	3.629	5.0	dB Max
	2.972	3.629	2.1	dB Typ
	3.019	3.586	1.5	dB Ripple
Rejection	DC	2.447	30	dB Min
	4.324	11.500	30	dB Min
	DC	2.292	40	dB Min
Dimensions	Thickness		22	Mils Max
	RF Power		Power	1 Watts Max

[Click here to return to main table.](#)



CLICK HERE TO DOWNLOAD DATA FILES

*Data files contain DXF and S2P files

DIMENSIONS – CASE SIZE E

Bottom View

inches (mm)

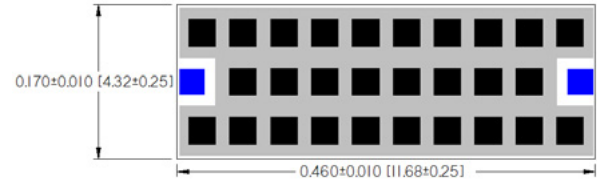

Typical Frequency Response

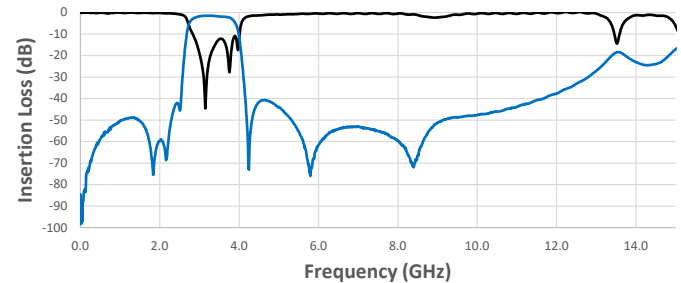

BP0EA3310A7**

ELECTRICAL SPECIFICATIONS

	Min (GHz)	Max (GHz)		
Pass Band	3.310		0.97	dB Fc Typ
	2.620	4.190	5.0	dB Max
	2.620	4.190	1.85	dB Typ
	2.695	4.107	1.5	dB Ripple
Rejection	DC	1.910	30	dB Min
	5.220	19.050	30	dB Min
	DC	1.860	40	dB Min
Dimension	Thickness		22	Mils Max
RF Power	Power		1	Watts Max

[Click here to return to main table.](#)



CLICK HERE TO DOWNLOAD DATA FILES

*Data files contain DXF and S2P files

DIMENSIONS – CASE SIZE E

Bottom View

inches (mm)

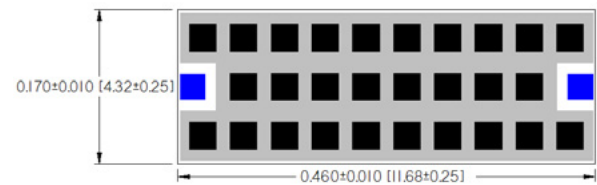

Typical Frequency Response

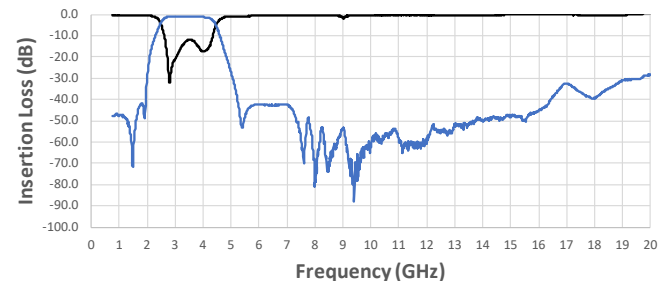

Multilayer Organic (MLO®) Filters

MLO® Band Pass Filters

BP0BA3350A7**

ELECTRICAL SPECIFICATIONS

	Min (GHz)	Max (GHz)		
Pass Band	3.350		2.3	dB Fc Typ
	3.208	3.506	5.0	dB Max
	3.208	3.506	2.3	dB Typ
	3.282	3.429	1.5	dB Ripple
Rejection	DC	2.386	30	dB Min
	4.480	9.000	30	dB Min
	DC	2.267	40	dB Min
	4.580	9.000	40	dB Min
Dimension	Thickness		22	Mils Max
RF Power	Power		1	Watts Max

[Click here to return to main table.](#)



CLICK HERE TO DOWNLOAD DATA FILES

*Data files contain DXF and S2P files

DIMENSIONS – CASE SIZE B

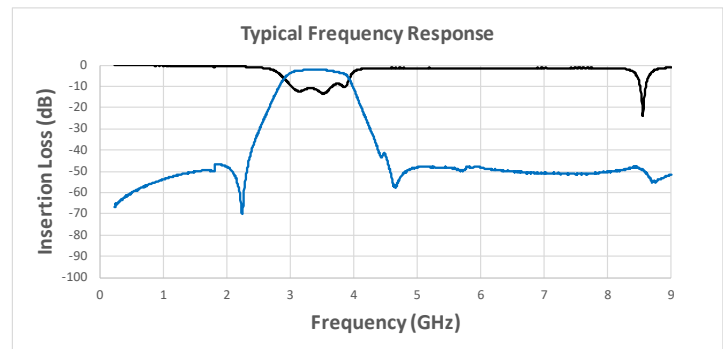
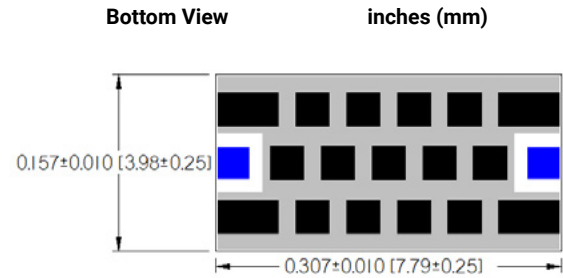

BP0EA3430A7**

ELECTRICAL SPECIFICATIONS

	Min (GHz)	Max (GHz)		
Pass Band	3.430		0.83	dB Fc Typ
	2.640	4.460	5.0	dB Max
	2.640	4.460	1.8	dB Typ
	2.683	4.370	1.5	dB Ripple
Rejection	DC	1.950	30	dB Min
	5.590	20.000	30	dB Min
	DC	1.890	40	dB Min
	5.830	16.000	40	dB Min
Dimension	Thickness		22	Mils Max
RF Power	Power		1	Watts Max

[Click here to return to main table.](#)



CLICK HERE TO DOWNLOAD DATA FILES

*Data files contain DXF and S2P files

DIMENSIONS – CASE SIZE E

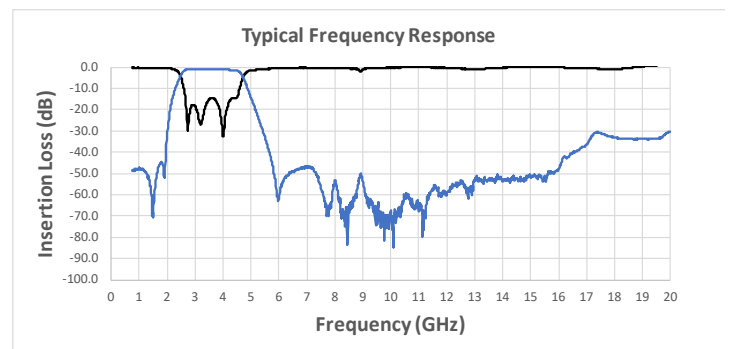
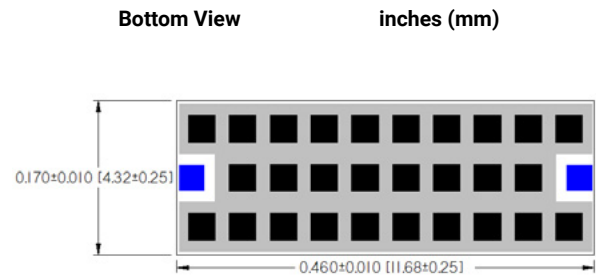

Multilayer Organic (MLO®) Filters

MLO® Band Pass Filters

BP0AA3580A7**

ELECTRICAL SPECIFICATIONS

	Min (GHz)	Max (GHz)		
Pass Band	3.580		1.2	dB Fc Typ
	2.943	4.351	5.0	dB Max
	2.943	4.351	1.6	dB Typ
	2.972	4.304	1.5	dB Ripple
Rejection	DC	2.068	30	dB Min
	5.292	9.000	30	dB Min
	6.300	9.000	40	dB Min
Dimension	Thickness		22	Mils Max
RF Power	Power		1	Watts Max

[Click here to return to main table.](#)



CLICK HERE TO DOWNLOAD DATA FILES

*Data files contain DXF and S2P files

DIMENSIONS – CASE SIZE A

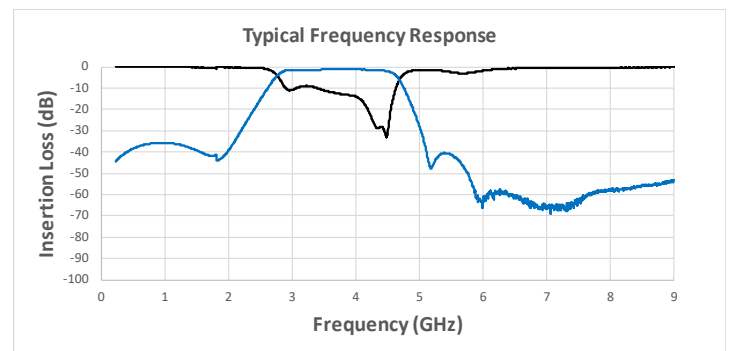
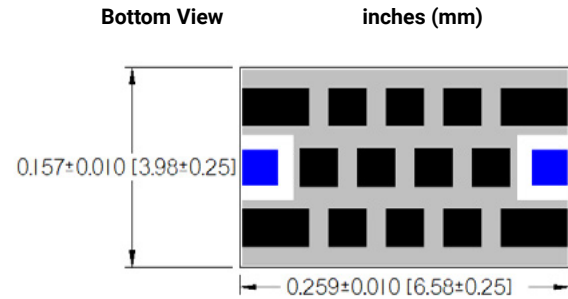

BP0EA3597A7**

ELECTRICAL SPECIFICATIONS

	Min (GHz)	Max (GHz)		
Pass Band	3.597		1.9	dB Fc Typ
	3.237	3.998	5.0	dB Max
	3.237	3.998	2.4	dB Typ
	3.325	3.923	1.5	dB Ripple
Rejection	DC	2.621	30	dB Min
	4.896	10.000	30	dB Min
	DC	2.538	40	dB Min
Dimensions	Thickness		22	Mils Max
RF Power	Power		1	Watts Max

[Click here to return to main table.](#)



CLICK HERE TO DOWNLOAD DATA FILES

*Data files contain DXF and S2P files

DIMENSIONS – CASE SIZE E

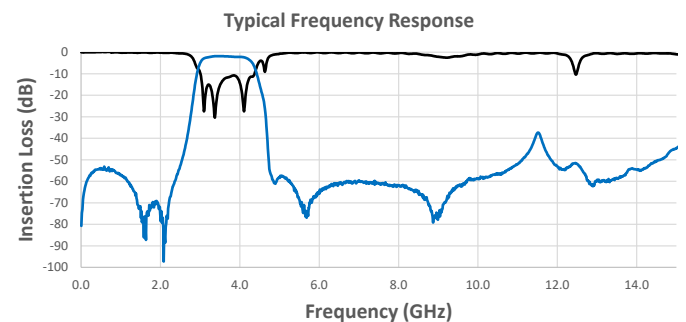
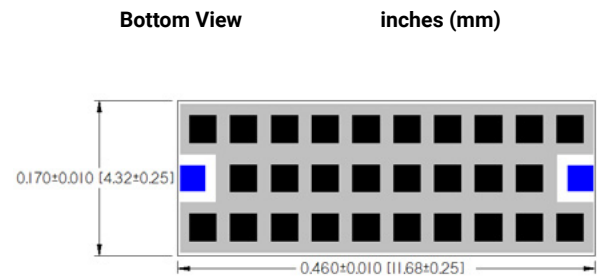

Multilayer Organic (MLO®) Filters

MLO® Band Pass Filters

BP0BA3630A7**

ELECTRICAL SPECIFICATIONS

	Min (GHz)	Max (GHz)		
Pass Band	3.630		2.1	dB Fc Typ
	3.438	3.829	5.0	dB Max
	3.438	3.829	2.2	dB Typ
	3.513	3.746	1.5	dB Ripple
Rejection	DC	2.594	30	dB Min
	4.884	9.000	30	dB Min
	DC	2.460	40	dB Min
5.039	9.000	40	dB Min	
Dimension	Thickness		22	Mils Max
RF Power	Power		1	Watts Max

[Click here to return to main table.](#)

CLICK HERE TO DOWNLOAD DATA FILES

*Data files contain DXF and S2P files

DIMENSIONS – CASE SIZE B

Bottom View inches (mm)

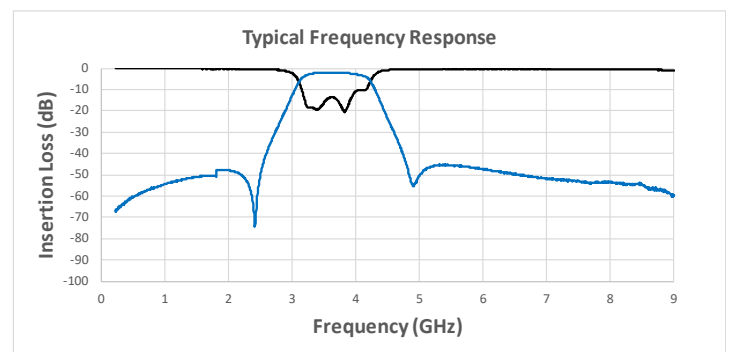
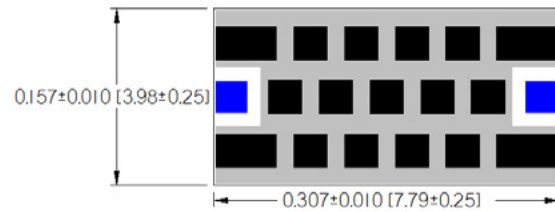

BP0AA3700A7**

ELECTRICAL SPECIFICATIONS

	Min (GHz)	Max (GHz)		
Pass Band	3.700		1.1	dB Fc Typ
	3.020	4.533	5.0	dB Max
	3.020	4.533	1.8	dB Typ
	3.046	4.481	1.5	dB Ripple
Rejection	DC	2.152	30	dB Min
	5.500	9.000	30	dB Min
	6.300	9.000	40	dB Min
Dimension	Thickness		22	Mils Max
RF Power	Power		2	Watts Max

[Click here to return to main table.](#)

CLICK HERE TO DOWNLOAD DATA FILES

*Data files contain DXF and S2P files

DIMENSIONS – CASE SIZE A

Bottom View inches (mm)

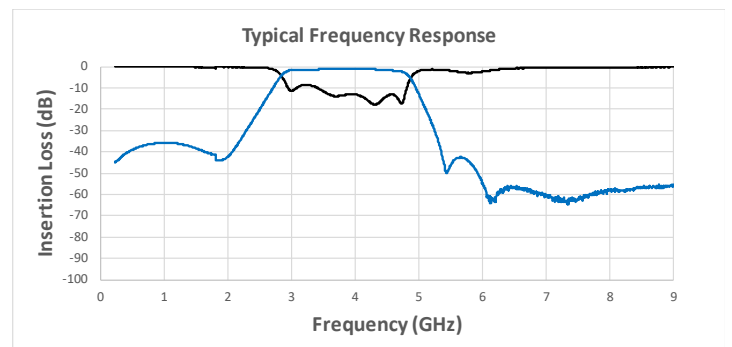
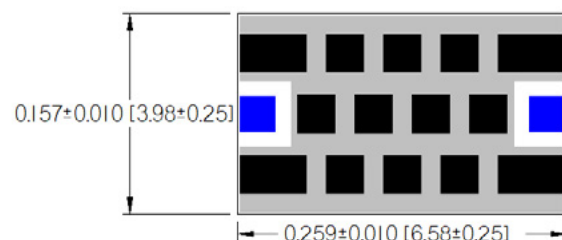

Multilayer Organic (MLO®) Filters

MLO® Band Pass Filters

BP0EA3720A7**

ELECTRICAL SPECIFICATIONS

	Min (GHz)	Max (GHz)		
Pass Band	3.720		2	dB Fc Typ
	3.319	4.169	5.0	dB Max
	3.319	4.169	2.5	dB Typ
	3.408	3.981	1.5	dB Ripple
Rejection	DC	2.661	30	dB Min
	5.051	12.500	30	dB Min
	DC	2.575	40	dB Min
Dimensions	Thickness		22	Mils Max
	RF Power		1	Watts Max

[Click here to return to main table.](#)

CLICK HERE TO DOWNLOAD DATA FILES

*Data files contain DXF and S2P files

DIMENSIONS – CASE SIZE E

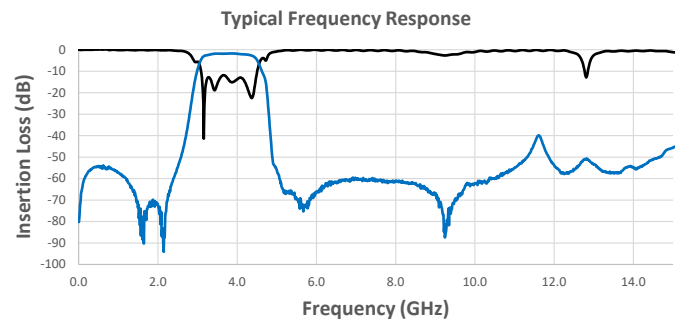
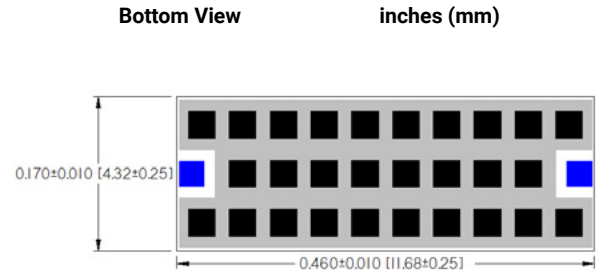

BP0BA3750A7**

ELECTRICAL SPECIFICATIONS

	Min (GHz)	Max (GHz)		
Pass Band	3.750		2.0	dB Fc Typ
	3.588	3.918	5.0	dB Max
	3.588	3.918	2.1	dB Typ
	3.657	3.835	1.5	dB Ripple
Rejection	DC	2.694	30	dB Min
	5.097	9.000	30	dB Min
	DC	2.558	40	dB Min
Dimension	Thickness		22	Mils Max
RF Power	Power		2	Watts Max

[Click here to return to main table.](#)

CLICK HERE TO DOWNLOAD DATA FILES

*Data files contain DXF and S2P files

DIMENSIONS – CASE SIZE B

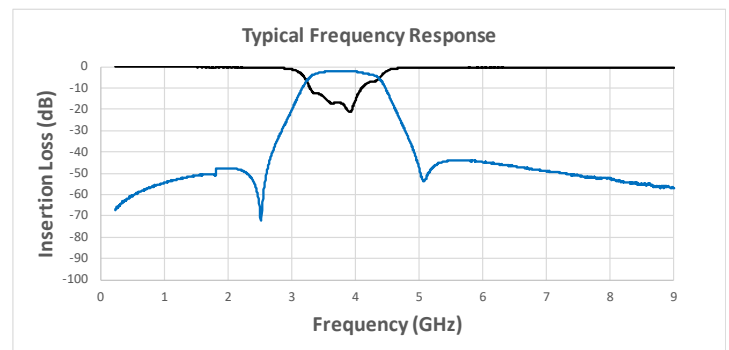
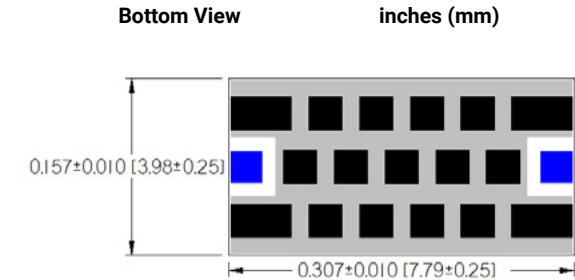

Multilayer Organic (MLO®) Filters

MLO® Band Pass Filters

BP0AA3790A7**

ELECTRICAL SPECIFICATIONS

	Min (GHz)	Max (GHz)		
Pass Band	3.790		1.0	dB Fc Typ
	3.150	4.646	5.0	dB Max
	3.150	4.646	2.1	dB Typ
	3.200	4.589	1.5	dB Ripple
Rejection	DC	2.199	30	dB Min
	5.661	9.000	30	dB Min
	6.060	9.000	40	dB Min
Dimension	Thickness		22	Mils Max
RF Power	Power		2	Watts Max

[Click here to return to main table.](#)



CLICK HERE TO DOWNLOAD DATA FILES

*Data files contain DXF and S2P files

DIMENSIONS – CASE SIZE A

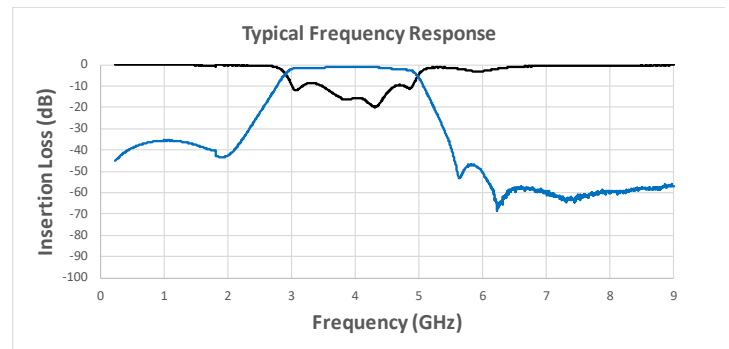
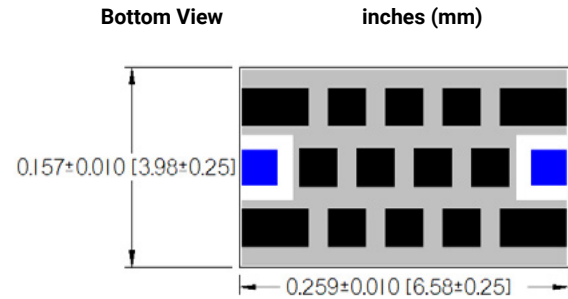

BP0EA3827A7**

ELECTRICAL SPECIFICATIONS

	Min (GHz)	Max (GHz)		
Pass Band	3.827		2.1	dB Fc Typ
	3.408	4.297	5.0	dB Max
	3.408	4.297	2.4	dB Typ
	3.508	4.169	1.5	dB Ripple
Rejection	DC	2.726	30	dB Min
	5.180	14.000	30	dB Min
	DC	2.640	40	dB Min
Dimensions	Thickness		22	Mils Max
RF Power	Power		1	Watts Max

[Click here to return to main table.](#)



CLICK HERE TO DOWNLOAD DATA FILES

*Data files contain DXF and S2P files

DIMENSIONS – CASE SIZE E

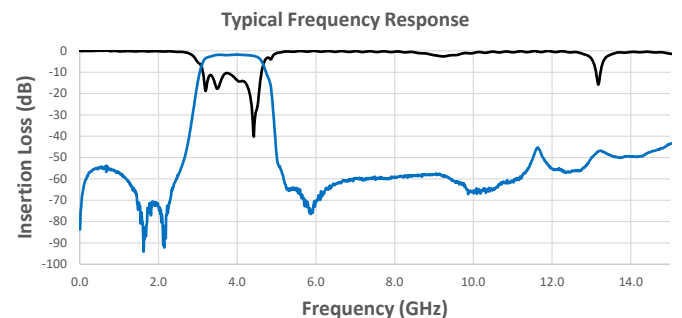
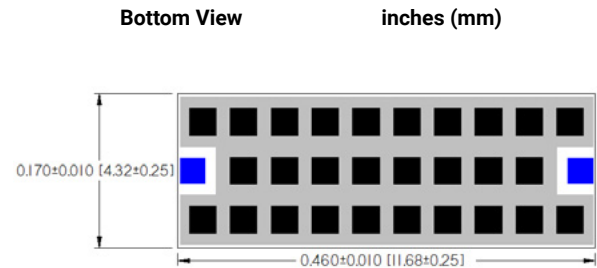

Multilayer Organic (MLO®) Filters

MLO® Band Pass Filters

BP0BA3900A7**

ELECTRICAL SPECIFICATIONS

	Min (GHz)	Max (GHz)		
Pass Band	3.900		2.0	dB Fc Typ
	3.755	4.058	5.0	dB Max
	3.755	4.058	2.2	dB Typ
	3.847	3.960	1.5	dB Ripple
Rejection	DC	2.735	30	dB Min
	5.229	9.000	30	dB Min
	DC	2.600	40	dB Min
Dimension	Thickness		22	Mils Max
	RF Power		Power	2

[Click here to return to main table.](#)



CLICK HERE TO DOWNLOAD DATA FILES

*Data files contain DXF and S2P files

DIMENSIONS – CASE SIZE B

Bottom View

inches (mm)

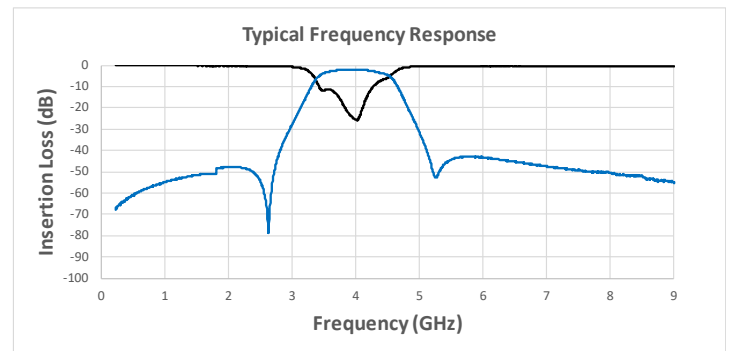
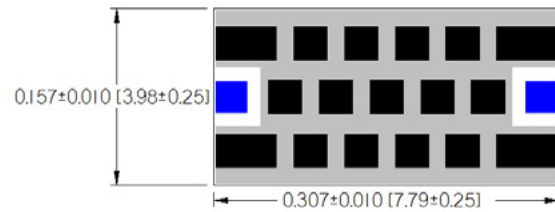

BP0EA4260A7**

ELECTRICAL SPECIFICATIONS

	Min (GHz)	Max (GHz)		
Pass Band	4.260		1.3	dB Fc Typ
	3.325	5.462	5.0	dB Max
	3.325	5.462	2.0	dB Typ
	3.389	5.422	1.5	dB Ripple
Rejection	DC	2.621	30	dB Min
	6.920	9.000	30	dB Min
	DC	2.261	40	dB Min
Dimension	Thickness		22	Mils Max
	RF Power		Power	2

[Click here to return to main table.](#)



CLICK HERE TO DOWNLOAD DATA FILES

*Data files contain DXF and S2P files

DIMENSIONS – CASE SIZE E

Bottom View

inches (mm)

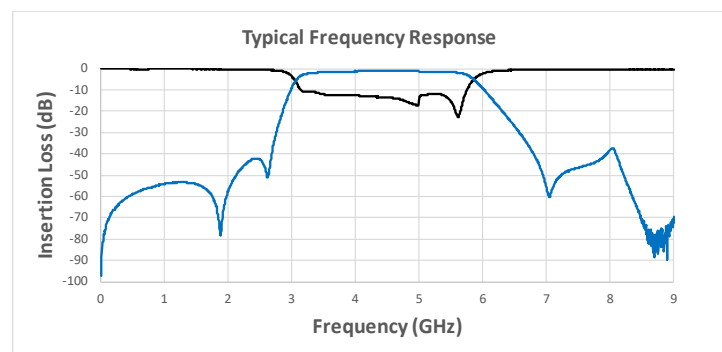
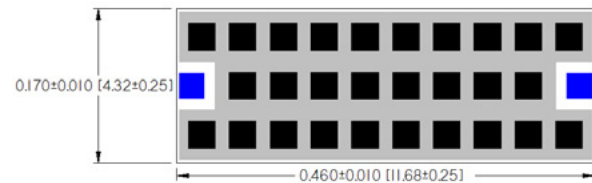

Multilayer Organic (MLO®) Filters

MLO® Band Pass Filters

BP0EA4363A7**

ELECTRICAL SPECIFICATIONS

	Min (GHz)	Max (GHz)		
Pass Band	4.363		1.6	dB Fc Typ
	3.863	4.927	5.0	dB Max
	3.863	4.927	2.2	dB Typ
	3.933	4.847	1.5	dB Ripple
Rejection	DC	3.121	30	dB Min
	6.019	13.000	30	dB Min
	DC	3.009	40	dB Min
	6.072	10.500	40	dB Min
Dimensions	Thickness		22	Mils Max
RF Power	Power		1	Watts Max

[Click here to return to main table.](#)

CLICK HERE TO DOWNLOAD DATA FILES

*Data files contain DXF and S2P files

DIMENSIONS – CASE SIZE E

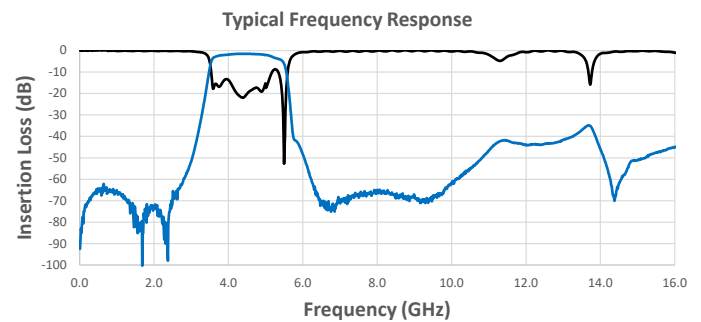
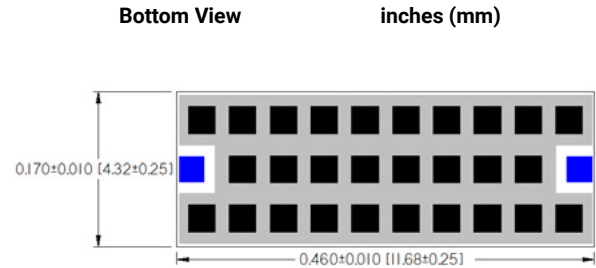

BP0EA4400A7**

ELECTRICAL SPECIFICATIONS

	Min (GHz)	Max (GHz)		
Pass Band	4.400		1.1	dB Fc Typ
	3.420	5.670	5.0	dB Max
	3.420	5.670	1.8	dB Typ
	3.456	5.627	1.5	dB Ripple
Rejection	DC	2.699	30	dB Min
	7.109	9.000	30	dB Min
	DC	2.613	40	dB Min
Dimension	Thickness		22	Mils Max
RF Power	Power		2	Watts Max

[Click here to return to main table.](#)

CLICK HERE TO DOWNLOAD DATA FILES

*Data files contain DXF and S2P files

DIMENSIONS – CASE SIZE E

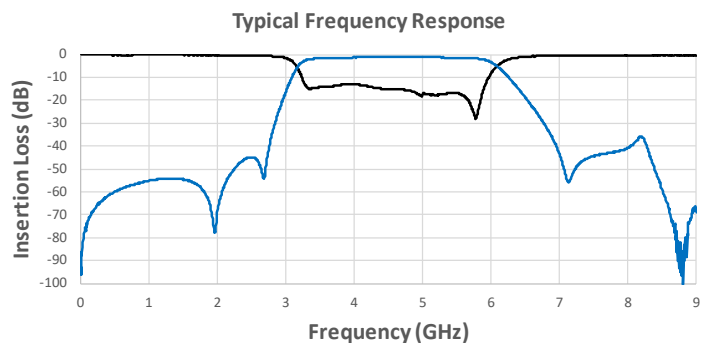
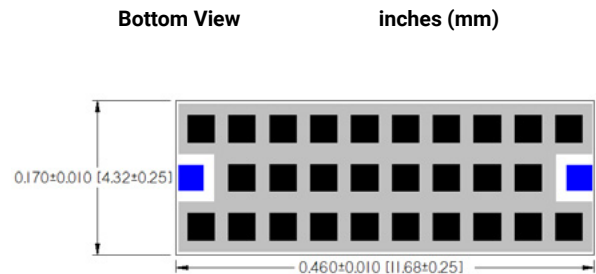

Multilayer Organic (MLO®) Filters

MLO® Band Pass Filters



BPOEA4440A7**

ELECTRICAL SPECIFICATIONS

	Min (GHz)	Max (GHz)		
Pass Band	4.440		1.1	dB Fc Typ
	3.490	5.660	5.0	dB Max
	3.490	5.660	1.8	dB Typ
	3.554	5.513	1.5	dB Ripple
Rejection	DC	2.827	30	dB Min
	7.079	9.025	30	dB Min
	DC	2.736	40	dB Min
7.419	7.838	40	dB Min	
Dimension	Thickness		22	Mils Max
RF Power	Power		2	Watts Max

[Click here to return to main table.](#)



CLICK HERE TO DOWNLOAD DATA FILES

*Data files contain DXF and S2P files

DIMENSIONS – CASE SIZE E

Bottom View

inches (mm)

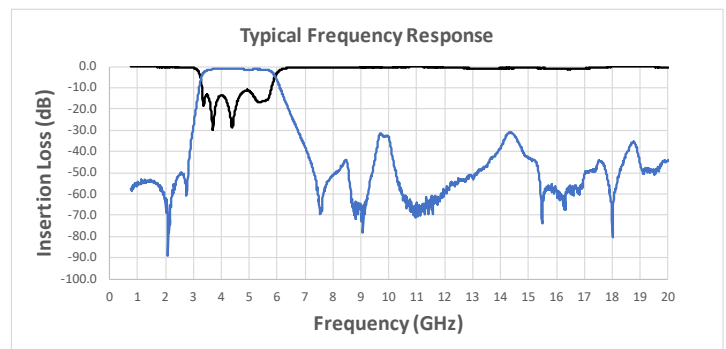
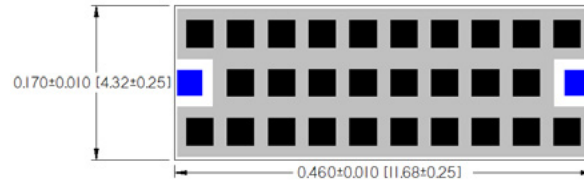

BPOEA4550A7**

ELECTRICAL SPECIFICATIONS

	Min (GHz)	Max (GHz)		
Pass Band	4.550		1.7	dB Fc Typ
	3.922	5.160	5.0	dB Max
	3.922	5.160	2	dB Typ
	4.052	5.071	1.5	dB Ripple
Rejection	DC	3.196	30	dB Min
	6.278	15.500	30	dB Min
	DC	3.196	40	dB Min
6.302	11.000	40	dB Min	
Dimensions	Thickness		22	Mils Max
RF Power	Power		1	Watts Max

[Click here to return to main table.](#)



CLICK HERE TO DOWNLOAD DATA FILES

*Data files contain DXF and S2P files

DIMENSIONS – CASE SIZE E

Bottom View

inches (mm)

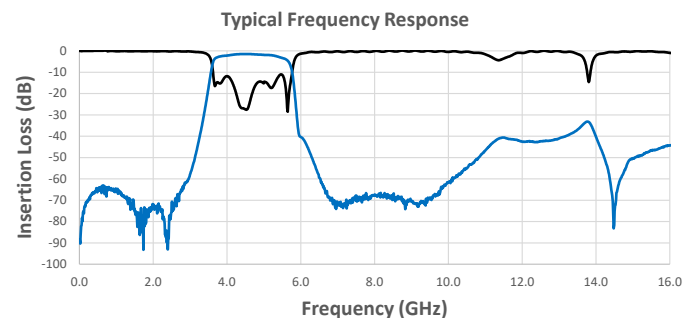
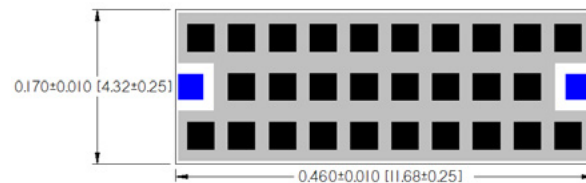

Multilayer Organic (MLO®) Filters

MLO® Band Pass Filters

BP0EA4583A7**

ELECTRICAL SPECIFICATIONS

	Min (GHz)	Max (GHz)		
Pass Band	4.583		1.1	dB Fc Typ
	3.521	5.979	5.0	dB Max
	3.521	5.979	1.6	dB Typ
	3.542	5.932	1.5	dB Ripple
Rejection	DC	2.770	30	dB Min
	7.419	9.000	30	dB Min
	DC	2.667	40	dB Min
Dimension	Thickness		22	Mils Max
RF Power	Power		2	Watts Max

[Click here to return to main table.](#)



CLICK HERE TO DOWNLOAD DATA FILES

*Data files contain DXF and S2P files

DIMENSIONS – CASE SIZE E

Bottom View

inches (mm)

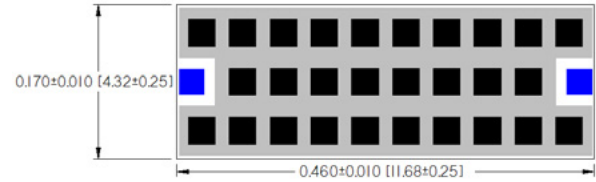

Typical Frequency Response

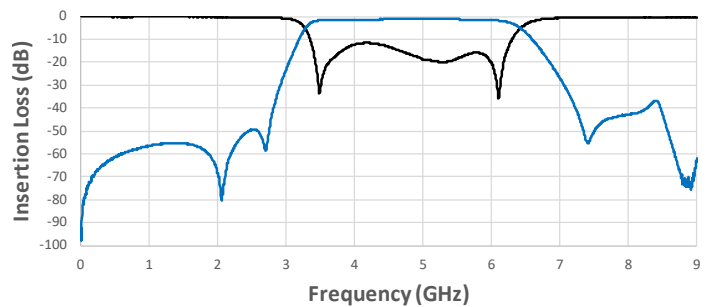

BP0EA4600A7**

ELECTRICAL SPECIFICATIONS

	Min (GHz)	Max (GHz)		
Pass Band	4.600		3.8	dB Fc Typ
	3.660	5.780	5.0	dB Max
	3.660	5.780	1.8	dB Typ
	3.806	5.696	1.5	dB Ripple
Rejection	DC	2.990	30	dB Min
	7.150	9.680	30	dB Min
	DC	2.900	40	dB Min
Dimension	Thickness		22	Mils Max
RF Power	Power		2	Watts Max

[Click here to return to main table.](#)



CLICK HERE TO DOWNLOAD DATA FILES

*Data files contain DXF and S2P files

DIMENSIONS – CASE SIZE E

Bottom View

inches (mm)

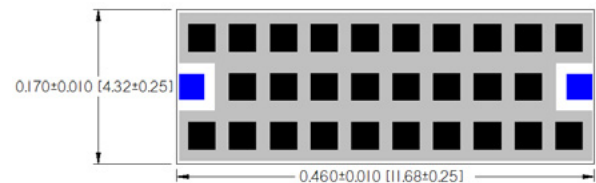

Typical Frequency Response

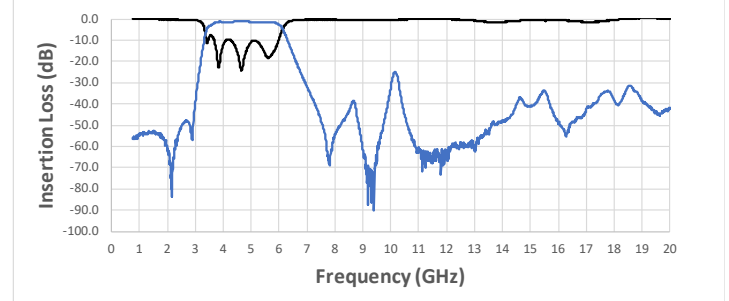

Multilayer Organic (MLO®) Filters

MLO® Band Pass Filters

BP0EA4649A7**

ELECTRICAL SPECIFICATIONS

	Min (GHz)	Max (GHz)		
Pass Band	4.649		1.8	dB Fc Typ
	4.016	5.381	5.0	dB Max
	4.016	5.381	2.7	dB Typ
	4.371	5.285	1.5	dB Ripple
Rejection	DC	3.259	30	dB Min
	6.497	12.000	30	dB Min
	DC	3.159	40	dB Min
Dimensions	Thickness		22	Mils Max
	RF Power		Power	1

[Click here to return to main table.](#)



CLICK HERE TO DOWNLOAD DATA FILES

*Data files contain DXF and S2P files

DIMENSIONS – CASE SIZE E

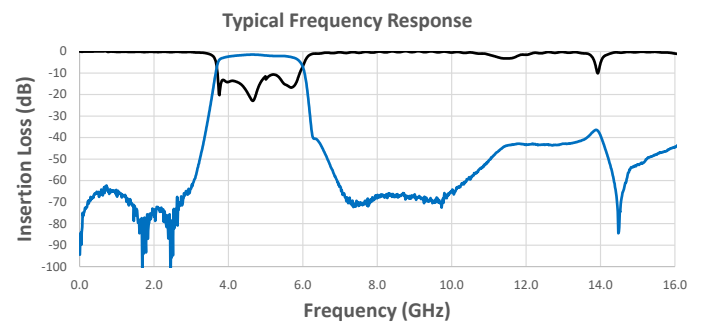
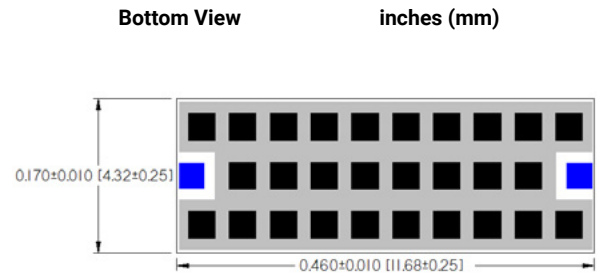

BP0EA4680A7**

ELECTRICAL SPECIFICATIONS

	Min (GHz)	Max (GHz)		
Pass Band	4.680		1.2	dB Fc Typ
	3.700	5.930	5.0	dB Max
	3.700	5.930	1.8	dB Typ
	3.743	5.776	1.5	dB Ripple
Rejection	DC	3.050	30	dB Min
	7.370	9.860	30	dB Min
	DC	2.960	40	dB Min
Dimension	Thickness		22	Mils Max
RF Power	Power		2	Watts Max

[Click here to return to main table.](#)



CLICK HERE TO DOWNLOAD DATA FILES

*Data files contain DXF and S2P files

DIMENSIONS – CASE SIZE E

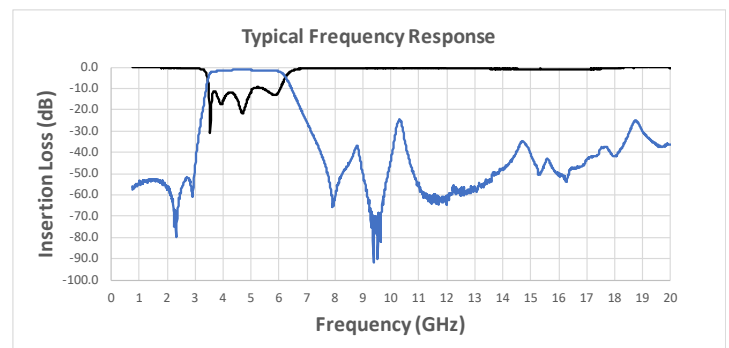
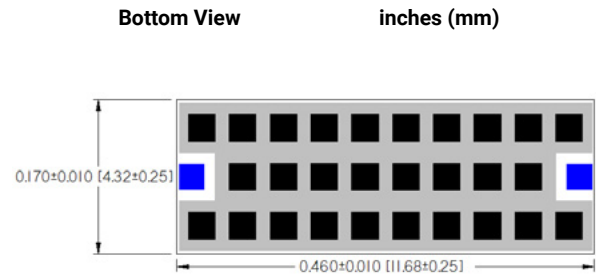

Multilayer Organic (MLO®) Filters

MLO® X Band Filters

General Information

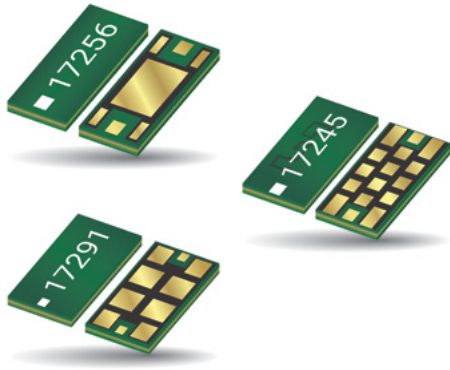

GENERAL DESCRIPTION

MLO® X Band Filters are low profile passive devices with best in class performance based on KYOCERA AVX's patented multilayer organic high density interconnect technology. MLO® X Band Filters utilize high dielectric constant and low loss materials to realize high Q passive printed elements, such as inductors and capacitors, in a multilayer stack. This results in a 50Ω MLO® X Band Filters design. MLO® X Band Filters can support both a variety of frequency bands and multiple wireless standards, and are less than 1.0mm in thickness. All filters are expansion matched to most organic PCB materials, thereby resulting in improved reliability over standard Si and ceramic devices.

FEATURES

- Wide Frequency Range
- Excellent Isolation
- Low Loss
- Expansion matched to PCB
- 50Ω Impedance
- Surface Mountable
- RoHS Compliant

APPLICATIONS

- Satellite
- Communications
- Radar
- Maritime Communications

LAND GRID ARRAY ADVANTAGES

- Inherent Low Profile
- Excellent Solderability
- Better Heat Dissipation

HOW TO ORDER

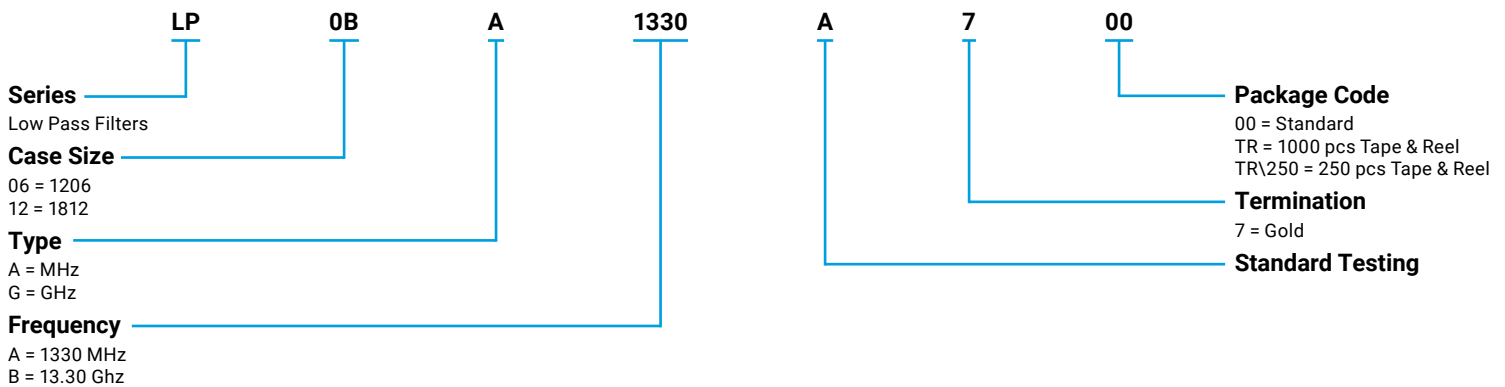

QUALITY INSPECTION

Finished Parts are 100% electrically tested

TERMINATION

All finishes are compatible with automatic soldering technologies: Pb free reflow, wave soldering, vapor phase, and manual soldering.

OPERATING TEMPERATURE

-55°C to +85°C



S2P FILES, DRAWING AND OTHER INFORMATION AVAILABLE IN LINK ON INDIVIDUAL DATASHEETS

Multilayer Organic (MLO®) Filters

MLO® X Band Filters

LOW PASS X BAND FILTERS

Part Number	IL <1.5 dB Passband DC- Fo (GHz)	Passband Typical	Typical 3dB	30 dB Rejection		Footprint	Thickness	
				Min	Max		Typical	Max
LP0AA7640A700	7.640	0.9	8.624	10.427	16.000	A	16	22
LP0AA7720A700	7.719	0.9	8.909	9.764	16.000	A	16	22
LP0AA8200A700	8.204	0.9	9.123	10.752	16.000	A	16	22
LP06A8750A700	8.750	0.9	10.21	12.926	28.500	1206	9	13
LP06A9230A700	9.232	0.9	10.75	13.073	28.500	1206	9	13
LP06A9410A700	9.421	0.9	11.51	13.787	28.500	1206	9	13
LP12G1020A700	10.213	0.9	12.31	13.923	20.653	1812	16	22
LP12G1040A700	10.441	0.9	12.92	14.952	21.100	1812	16	22
LP12G1070A700	10.697	0.9	12.94	14.69	21.651	1812	16	22

 Click on part number to see full specifications

HIGH PASS X BAND FILTERS

Part number	IL <2 dB Passband		Passband Typical	Typical 3dB	30 dB Rejection	Footprint	Thickness	
	Min	Max					Typical	Max
HF12A7750A700	7.746	19.000	1	6.985	6004	1812	26	28
HF12A8000A700	8.007	19.000	1	7.199	6173	1812	26	28
HF12A8360A700	8.357	19.000	1	7.448	6399	1812	26	28
HF06G1270A700	12.695	27.550	1	10.43	8360	1206	26	28
HF06G1280A700	12.747	28.158	1	10.58	8337	1206	26	28
HF06G1340A700	13.440	28.757	1	11.14	8824	1206	26	28

 Click on part number to see full specifications

Multilayer Organic (MLO®) Filters

MLO® X Band Low Pass Filters

LP0AA7640A7**

ELECTRICAL SPECIFICATIONS

Pass Band	DC - 7.64	1.5 dB	Max
	DC - 7.64	0.9 dB	Typical
	3dB cutoff	8.624 dB	Typical
Rejection	10.427 - 16.000	30 dB	Min
Dimension	Thickness	16 mils	Typical
		22 mils	Max

[Click here to return to main table.](#)



CLICK HERE TO DOWNLOAD DATA FILES

*Data files contain DXF and S2P files

DIMENSIONS – CASE SIZE A

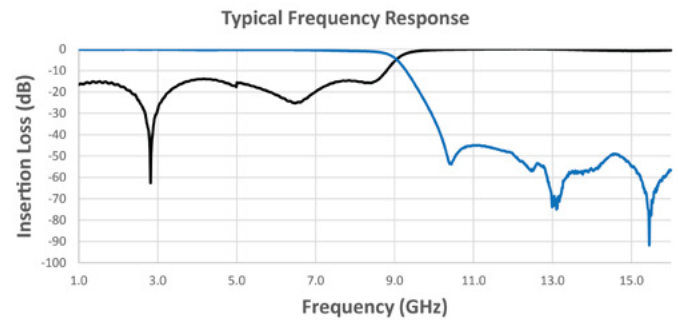
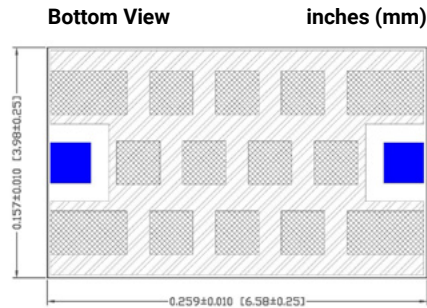

LP0AA7720A7**

ELECTRICAL SPECIFICATIONS

Pass Band	DC - 7.719	1.5 dB	Max
	DC - 7.719	0.9 dB	Typical
	3dB cutoff	8.909 dB	Typical
Rejection	9.764 - 16.000	30 dB	Min
Dimension	Thickness	16 mils	Typical
		22 mils	Max

[Click here to return to main table.](#)



CLICK HERE TO DOWNLOAD DATA FILES

*Data files contain DXF and S2P files

DIMENSIONS – CASE SIZE A

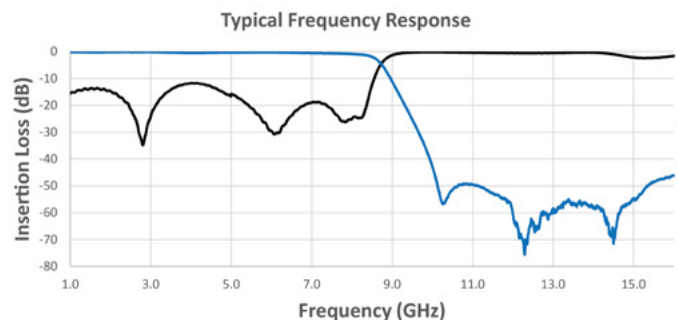
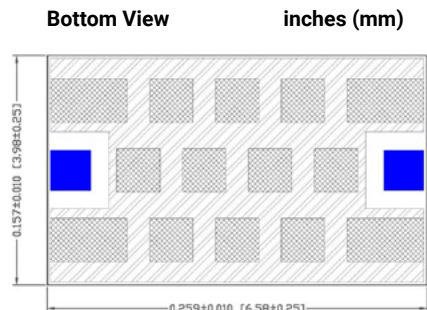

Multilayer Organic (MLO®) Filters

MLO® X Band Low Pass Filters

LP0AA8200A7**

ELECTRICAL SPECIFICATIONS

Pass Band	DC - 8.204	1.5 dB	Max
	DC - 8.204	0.9 dB	Typical
	3dB cutoff	9.123 dB	Typical
Rejection	10.752 - 16.000	30 dB	Min
Dimension	Thickness	16 mils	Typical
		22 mils	Max

[Click here to return to main table.](#)

DIMENSIONS – CASE SIZE A

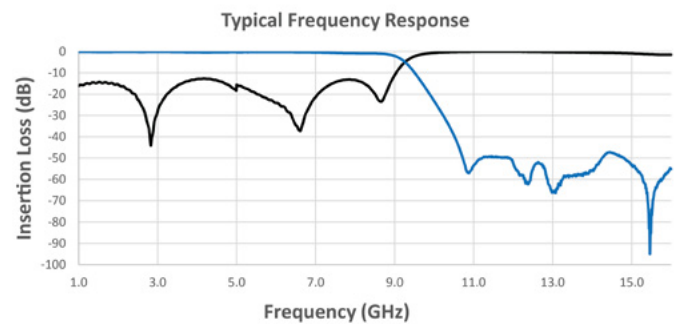
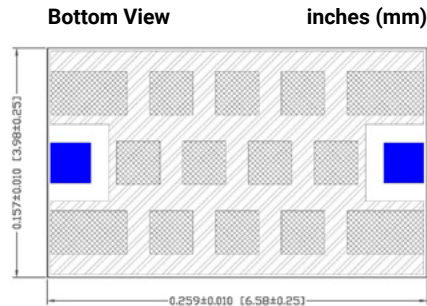

[CLICK HERE TO DOWNLOAD DATA FILES](#)

*Data files contain DXF and S2P files

LP06A8750A7**

ELECTRICAL SPECIFICATIONS

Pass Band	DC - 8.75	1.5 dB	Max
	DC - 8.75	0.9 dB	Typical
	3dB cutoff	10.21 dB	Typical
Rejection	12.926 - 28.500	30 dB	Min
Dimension	Thickness	9 mils	Typical
		13 mils	Max

[Click here to return to main table.](#)

DIMENSIONS – CASE SIZE 1206

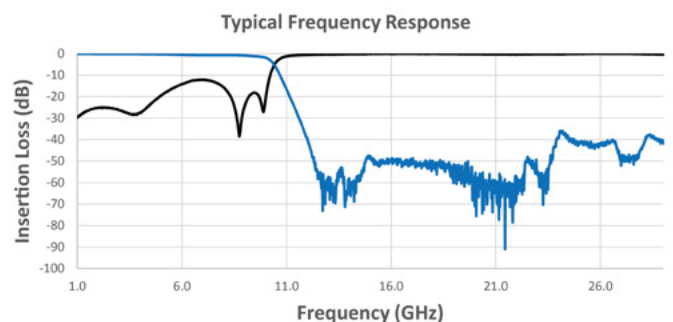
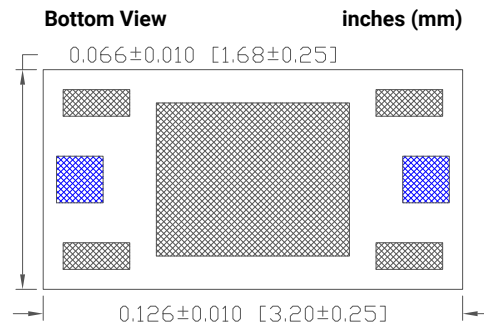

[CLICK HERE TO DOWNLOAD DATA FILES](#)

*Data files contain DXF and S2P files

Multilayer Organic (MLO®) Filters

MLO® X Band Low Pass Filters

LP06A9230A7**

ELECTRICAL SPECIFICATIONS

Pass Band	DC - 9.232	1.5 dB	Max
	DC - 9.232	0.9 dB	Typical
	3dB cutoff	10.75 dB	Typical
Rejection	13.073 - 28.500	30 dB	Min
Dimension	Thickness	9 mils	Typical
		13 mils	Max

[Click here to return to main table.](#)

CLICK HERE TO DOWNLOAD DATA FILES

*Data files contain DXF and S2P files

DIMENSIONS – CASE SIZE 1206

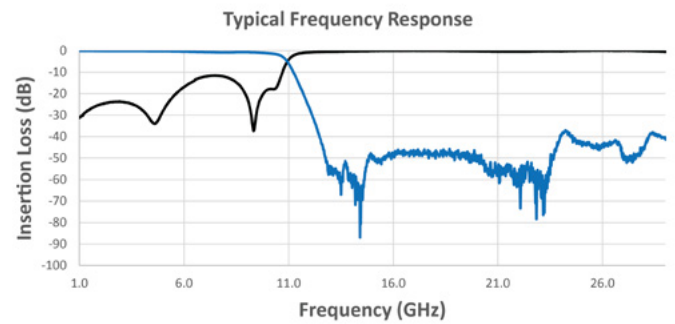
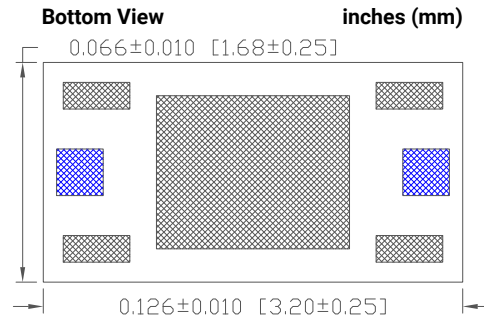

LP06A9410A7**

ELECTRICAL SPECIFICATIONS

Pass Band	DC - 9.421	1.5 dB	Max
	DC - 9.421	0.9 dB	Typical
	3dB cutoff	11.51 dB	Typical
Rejection	13.787 - 28.500	30 dB	Min
Dimension	Thickness	9 mils	Typical
		13 mils	Max

[Click here to return to main table.](#)

CLICK HERE TO DOWNLOAD DATA FILES

*Data files contain DXF and S2P files

DIMENSIONS – CASE SIZE 1206

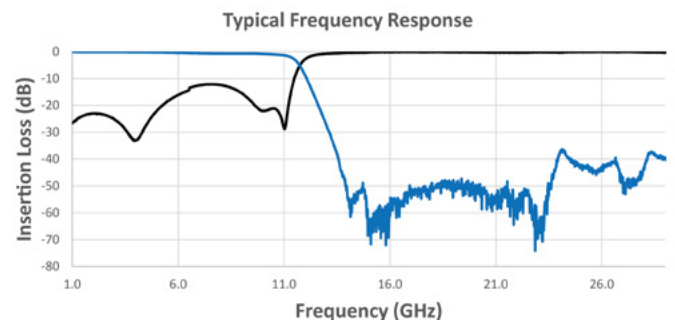
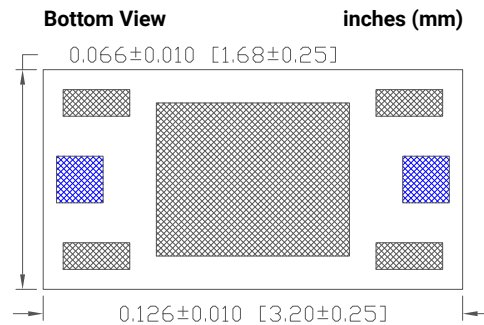

Multilayer Organic (MLO®) Filters

MLO® X Band Low Pass Filters

LP12G1020A7**

ELECTRICAL SPECIFICATIONS

Pass Band	DC - 10.213	1.5 dB	Max
	DC - 10.213	0.9 dB	Typical
	3dB cutoff	12.31 dB	Typical
Rejection	13.923 - 20.653	30 dB	Min
Dimension	Thickness	16 mils	Typical
		22 mils	Max

[Click here to return to main table.](#)



CLICK HERE TO DOWNLOAD DATA FILES

*Data files contain DXF and S2P files

DIMENSIONS – CASE SIZE 1812

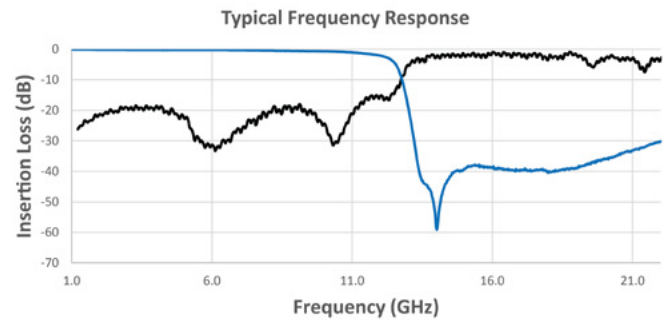
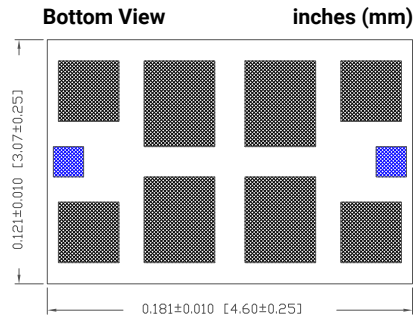

LP12G1040A7**

ELECTRICAL SPECIFICATIONS

Pass Band	DC - 10.441	1.5 dB	Max
	DC - 10.441	0.9 dB	Typical
	3dB cutoff	12.92 dB	Typical
Rejection	14.952 - 21.100	30 dB	Min
Dimension	Thickness	16 mils	Typical
		22 mils	Max

[Click here to return to main table.](#)



CLICK HERE TO DOWNLOAD DATA FILES

*Data files contain DXF and S2P files

DIMENSIONS – CASE SIZE 1812

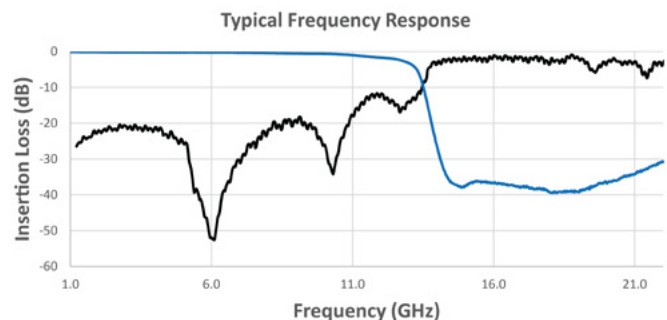
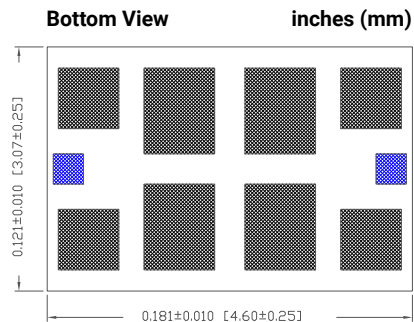

Multilayer Organic (MLO®) Filters

MLO® X Band Low Pass Filters

LP12G1070A7**

ELECTRICAL SPECIFICATIONS

Pass Band	DC - 10.697	1.5 dB	Max
	DC - 10.697	0.9 dB	Typical
	3dB cutoff	12.94 dB	Typical
Rejection	14.690 - 21.651	30 dB	Min
Dimension	Thickness	16 mils	Typical
		22 mils	Max

[Click here to return to main table.](#)



CLICK HERE TO DOWNLOAD DATA FILES

*Data files contain DXF and S2P files

DIMENSIONS – CASE SIZE 1812

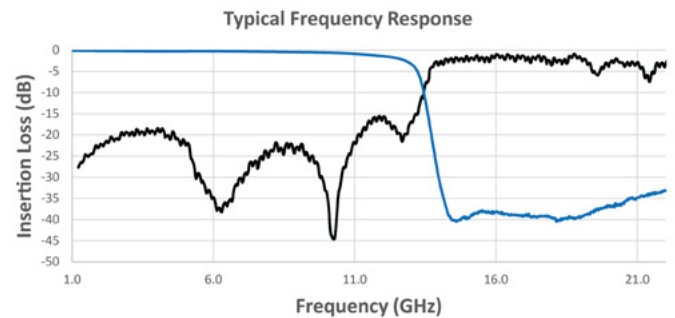
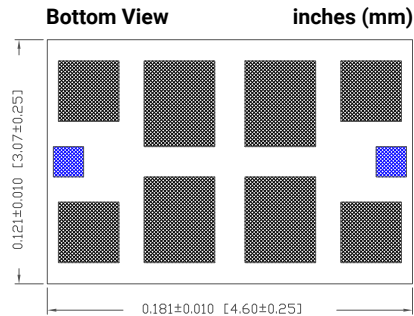

HF12A7750A7**

ELECTRICAL SPECIFICATIONS

Pass Band	DC - 7.746	2 dB	Max
	DC - 7.746	1 dB	Typical
	3dB cutoff	6.985 dB	Typical
Rejection	DC - 6.004	30 dB	Min
Dimension	Thickness	26 mils	Typical
		28 mils	Max

[Click here to return to main table.](#)



CLICK HERE TO DOWNLOAD DATA FILES

*Data files contain DXF and S2P files

DIMENSIONS – CASE SIZE 1812

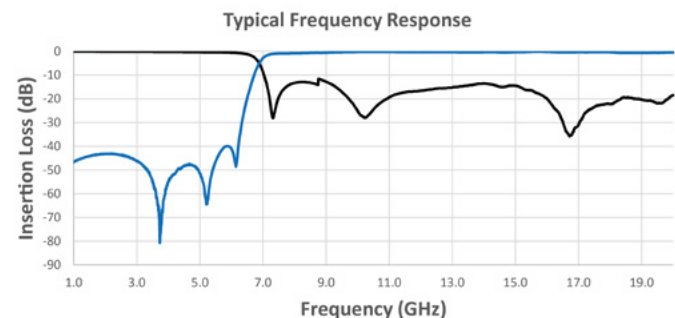
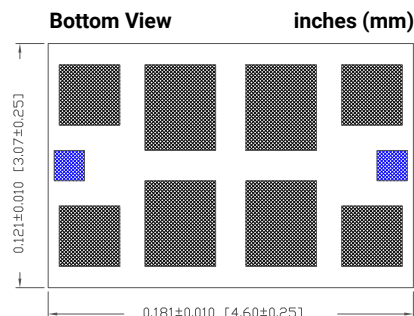

Multilayer Organic (MLO®) Filters

MLO® X Band High Pass Filters

HF12A8000A7**

ELECTRICAL SPECIFICATIONS

Pass Band	DC - 8.007	2 dB	Max
	DC - 8.007	1 dB	Typical
	3dB cutoff	7.199 dB	Typical
Rejection	DC - 6.173	30 dB	Min
Dimension	Thickness	26 mils	Typical
		28 mils	Max

[Click here to return to main table.](#)



CLICK HERE TO DOWNLOAD DATA FILES

*Data files contain DXF and S2P files

DIMENSIONS – CASE SIZE 1812

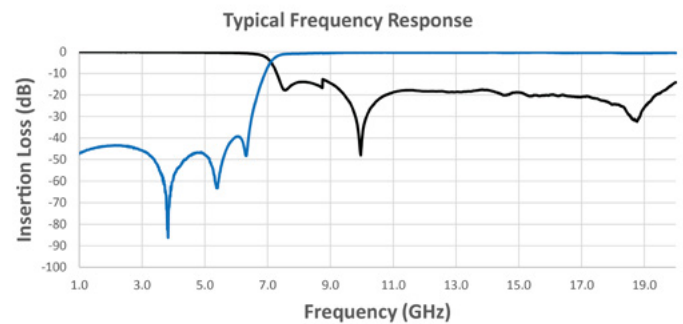
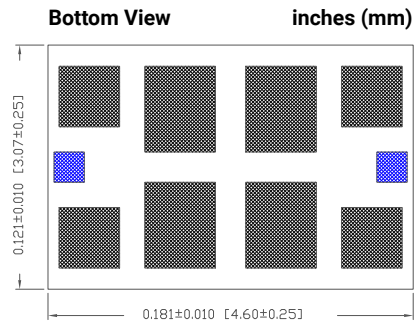

HF12A8360A7**

ELECTRICAL SPECIFICATIONS

Pass Band	DC - 8.357	2 dB	Max
	DC - 8.357	1 dB	Typical
	3dB cutoff	7.448 dB	Typical
Rejection	DC - 6.399	30 dB	Min
Dimension	Thickness	26 mils	Typical
		28 mils	Max

[Click here to return to main table.](#)



CLICK HERE TO DOWNLOAD DATA FILES

*Data files contain DXF and S2P files

DIMENSIONS – CASE SIZE 1812

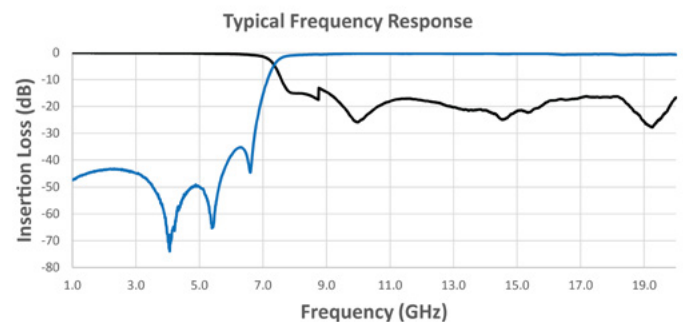
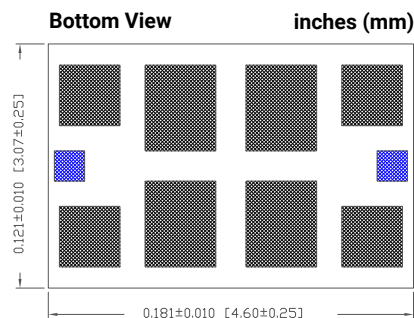

Multilayer Organic (MLO®) Filters

MLO® X Band High Pass Filters

HF06G1270A7**

ELECTRICAL SPECIFICATIONS

Pass Band	DC - 12.695	2 dB	Max
	DC - 12.695	1 dB	Typical
	3dB cutoff	10.43 dB	Typical
Rejection	DC - 8.360	30 dB	Min
Dimension	Thickness	26 mils	Typical
		28 mils	Max

[Click here to return to main table.](#)

CLICK HERE TO DOWNLOAD DATA FILES

*Data files contain DXF and S2P files

DIMENSIONS – CASE SIZE 1206

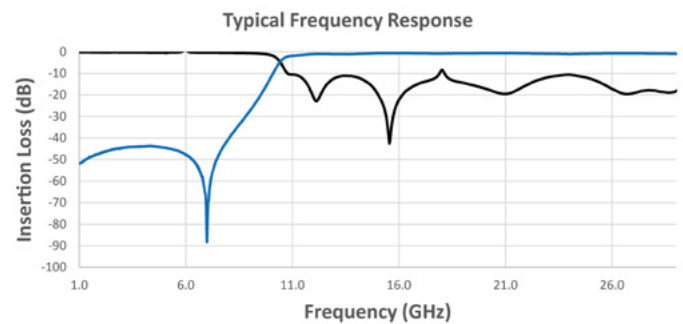
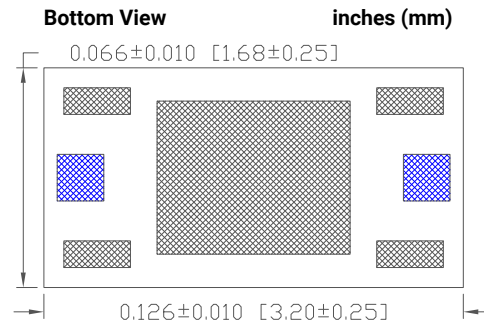

HF06G1280A7**

ELECTRICAL SPECIFICATIONS

Pass Band	DC - 12.747	2 dB	Max
	DC - 12.747	1 dB	Typical
	3dB cutoff	10.58 dB	Typical
Rejection	DC - 8.337	30 dB	Min
Dimension	Thickness	26 mils	Typical
		28 mils	Max

[Click here to return to main table.](#)

CLICK HERE TO DOWNLOAD DATA FILES

*Data files contain DXF and S2P files

DIMENSIONS – CASE SIZE 1206

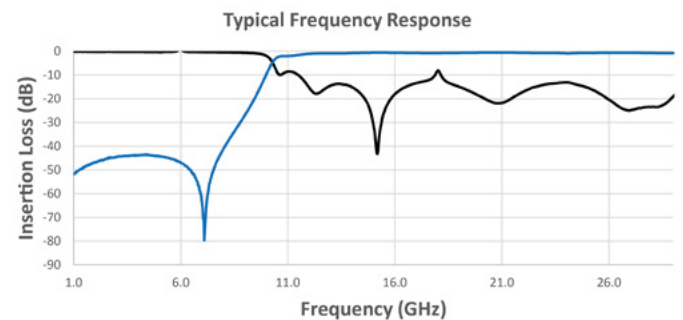
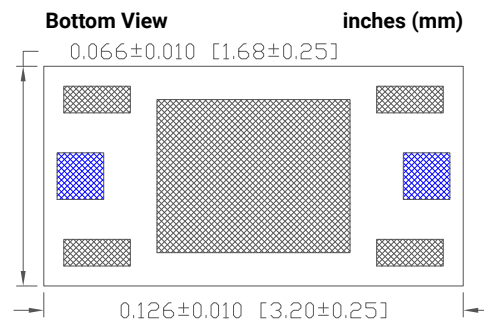

Multilayer Organic (MLO®) Filters

MLO® X Band High Pass Filters

HF06G1340A7**

ELECTRICAL SPECIFICATIONS

Pass Band	DC - 13.44	2 dB	Max
	DC - 13.44	1 dB	Typical
	3dB cutoff	11.14 dB	Typical
Rejection	DC - 8.824	30 dB	Min
Dimension	Thickness	26 mils	Typical
		28 mils	Max

[Click here to return to main table.](#)

DIMENSIONS – CASE SIZE 1206

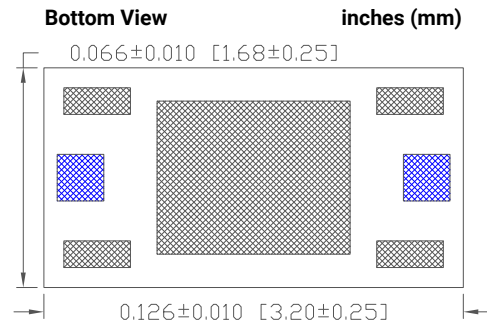

CLICK HERE TO DOWNLOAD DATA FILES

*Data files contain DXF and S2P files

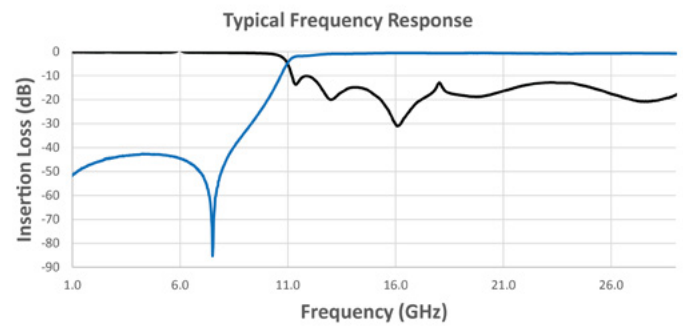

Multilayer Organic (MLO®) Filters

Mechanical Specifications, Pad Layout, and Mounting Recommendations

Footprint A



MECHANICAL SPECIFICATIONS

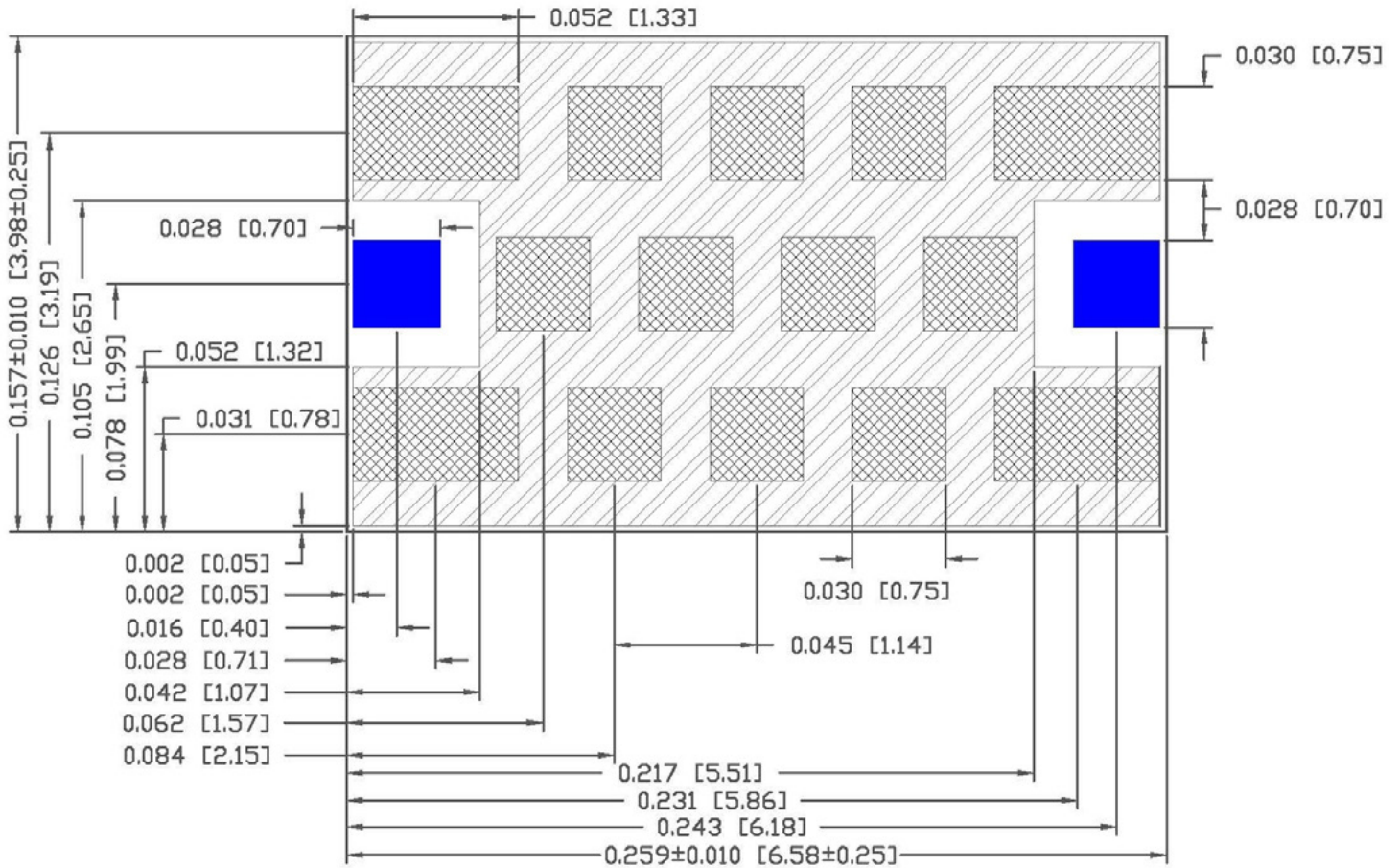

Input / output pads shown in Blue. Grounding pads shown in gray.

Dimensions in inches [mm]

Tolerances are +/-0.002 [0.05], unless noted.

Dimensions nominal unless otherwise noted.

All contact areas are gold plated, including I/O pads.

100 mil cavity height above device. Please contact factory if alternate clearance is needed

Multilayer Organic (MLO®) Filters

Mechanical Specifications, Pad Layout, and Mounting Recommendations

Footprint A



SUGGESTED PCB LAYOUT

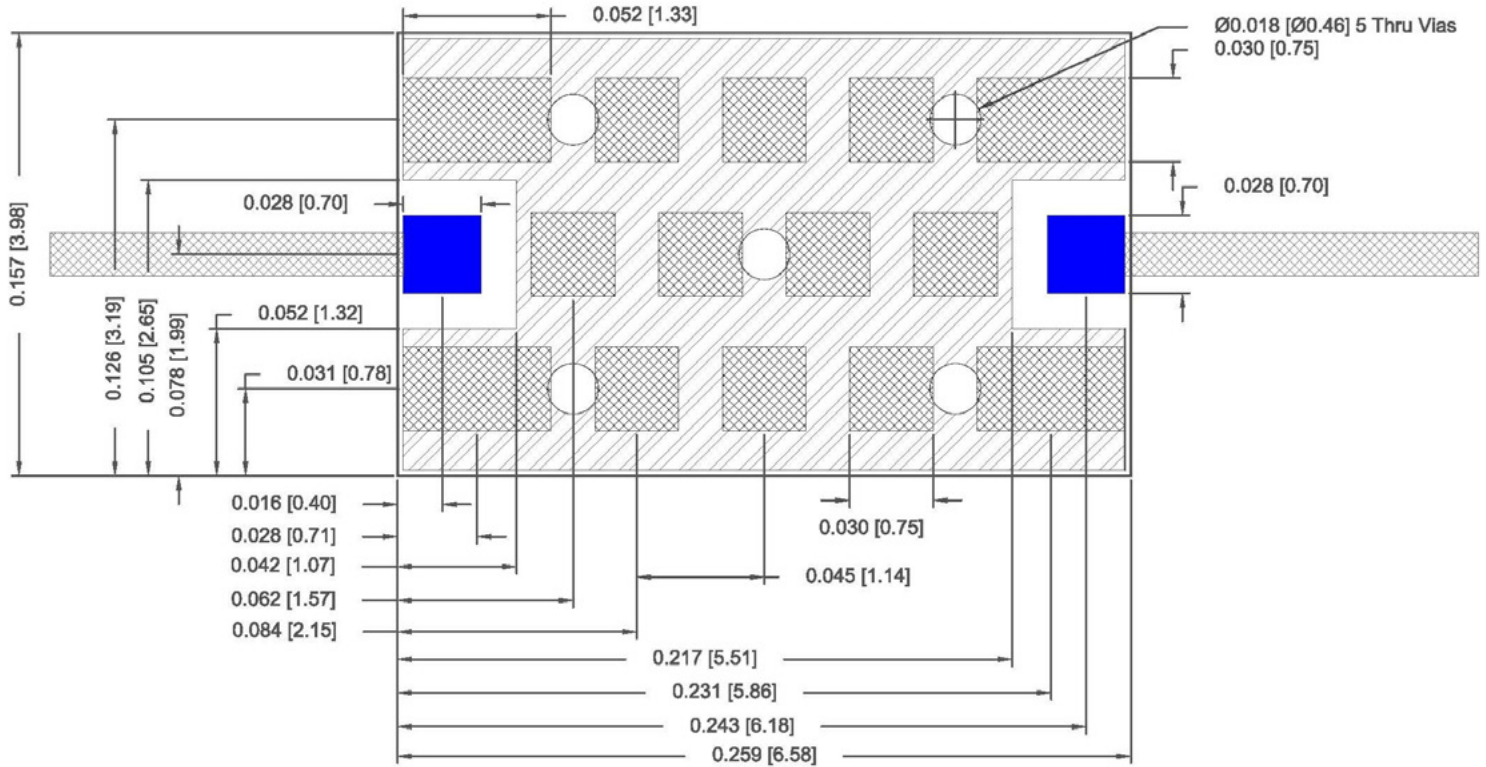

Dimensions in inches [mm].

Dimensions nominal unless otherwise noted.

Line width for I/O pads should be designed to match 50-ohm characteristic impedance, depending on PCB material and thickness. Grounding for these lines not shown.

Please see DXF file in part data package.

All contact areas are gold plated, including I/O pads.

Grounding is solid copper under solder mask, with solder mask defined pads for ground openings. I/O pads are not shorted to ground.

Multilayer Organic (MLO®) Filters

Mechanical Specifications, Pad Layout, and Mounting Recommendations

Footprint A



PAD CONNECTIONS

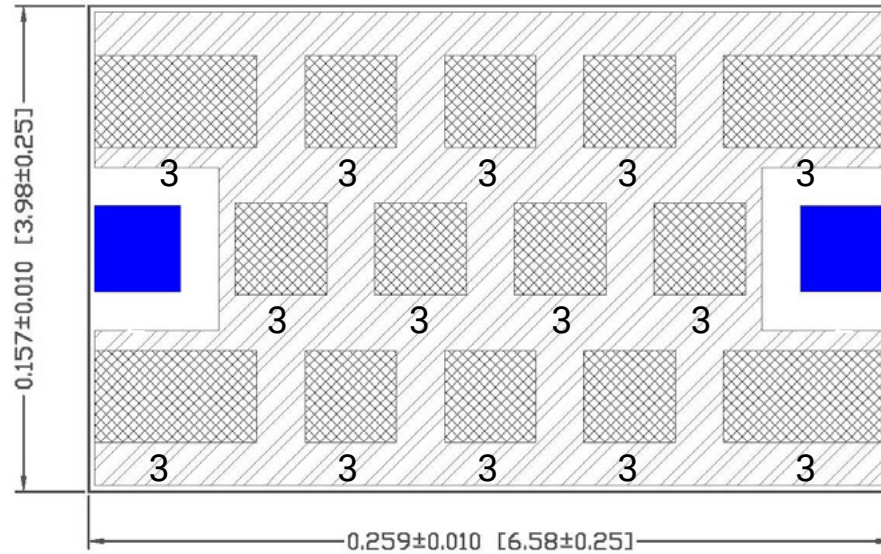

Pins 1 & 2 are input / output. Shown in Blue.

Pin 3 - grounding pads. Shown in gray.

Dimensions in inches [mm]

Multilayer Organic (MLO®) Filters

Mechanical Specifications, Pad Layout, and Mounting Recommendations

Footprint B



MECHANICAL SPECIFICATIONS

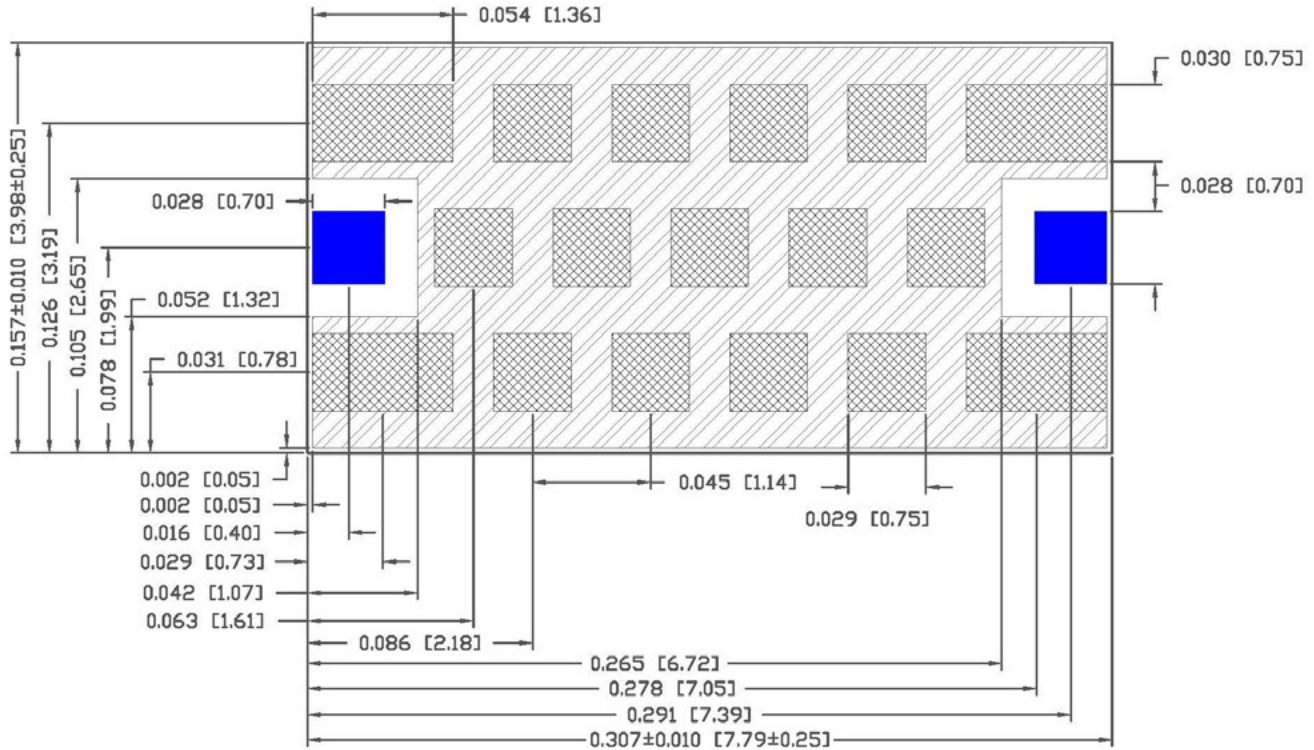

Input / output pads shown in Blue. Grounding pads shown in gray.

Dimensions in inches [mm]

Tolerances are +/-0.002 [0.05], unless noted.

Dimensions nominal unless otherwise noted.

All contact areas are gold plated, including I/O pads.

100 mil cavity height above device. Please contact factory if alternate clearance is needed

Multilayer Organic (MLO®) Filters

Mechanical Specifications, Pad Layout, and Mounting Recommendations

Footprint B



SUGGESTED PCB LAYOUT

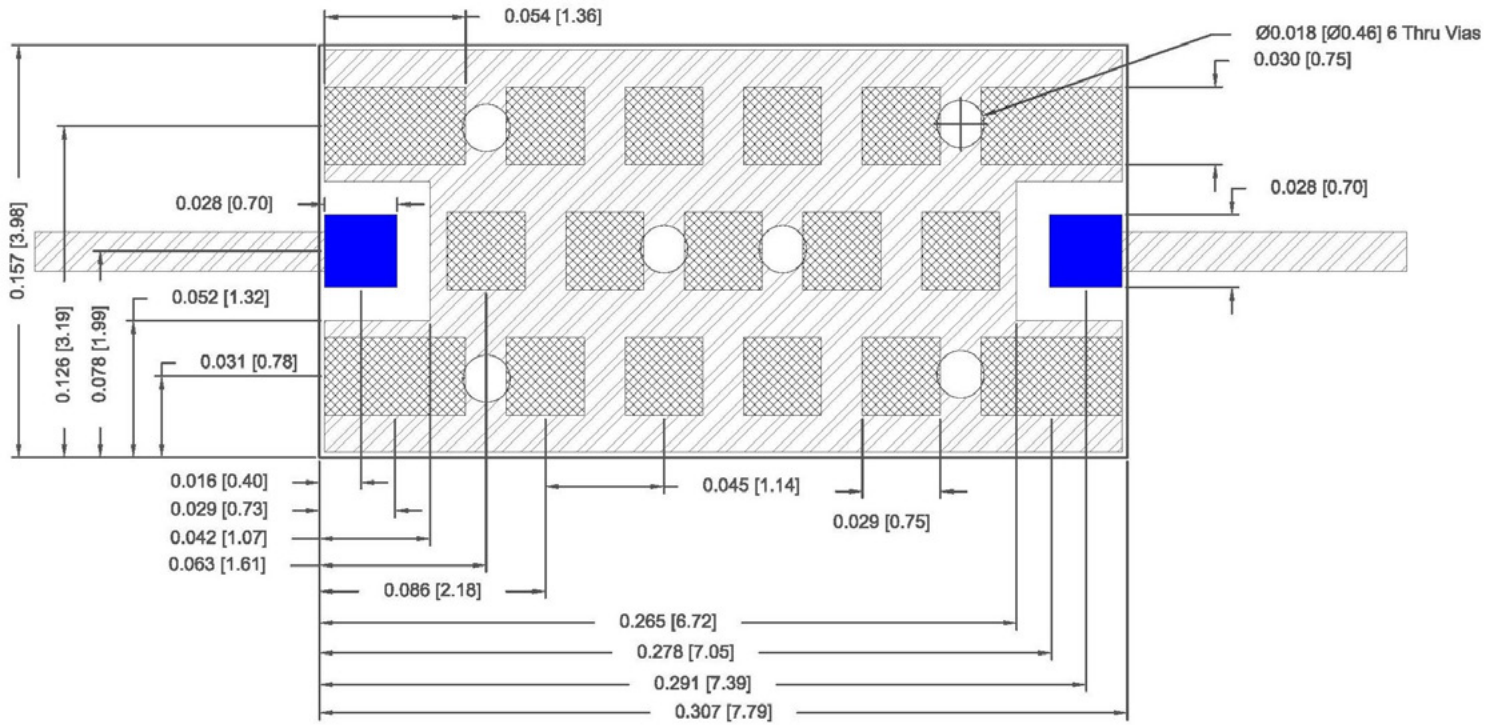

Dimensions in inches [mm].

Dimensions nominal unless otherwise noted.

Line width for I/O pads should be designed to match 50-ohm characteristic impedance, depending on PCB material and thickness. Grounding for these lines not shown.

Please see DXF file in part data package.

All contact areas are gold plated, including I/O pads.

Grounding is solid copper under solder mask, with solder mask defined pads for ground openings. I/O pads are not shorted to ground.

Multilayer Organic (MLO®) Filters

Mechanical Specifications, Pad Layout, and Mounting Recommendations

Footprint B

PAD CONNECTIONS

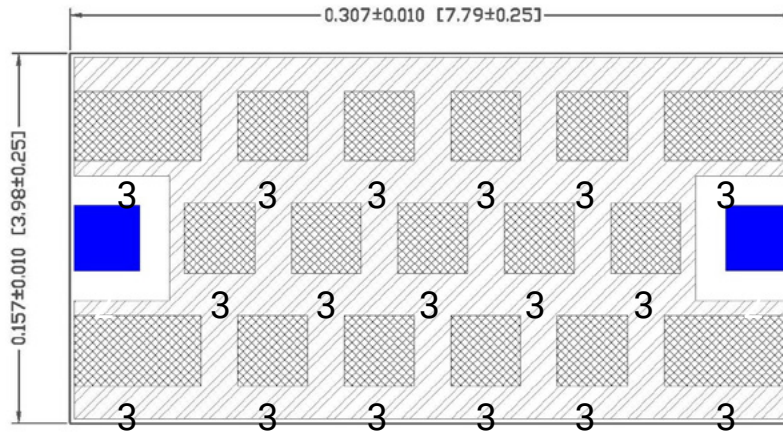

Pins 1 & 2 are input / output. Shown in Blue.
Pin 3 - grounding pads. Shown in gray.
Dimensions in inches [mm]

Multilayer Organic (MLO®) Filters

Mechanical Specifications, Pad Layout, and Mounting Recommendations

Footprint C



MECHANICAL SPECIFICATIONS

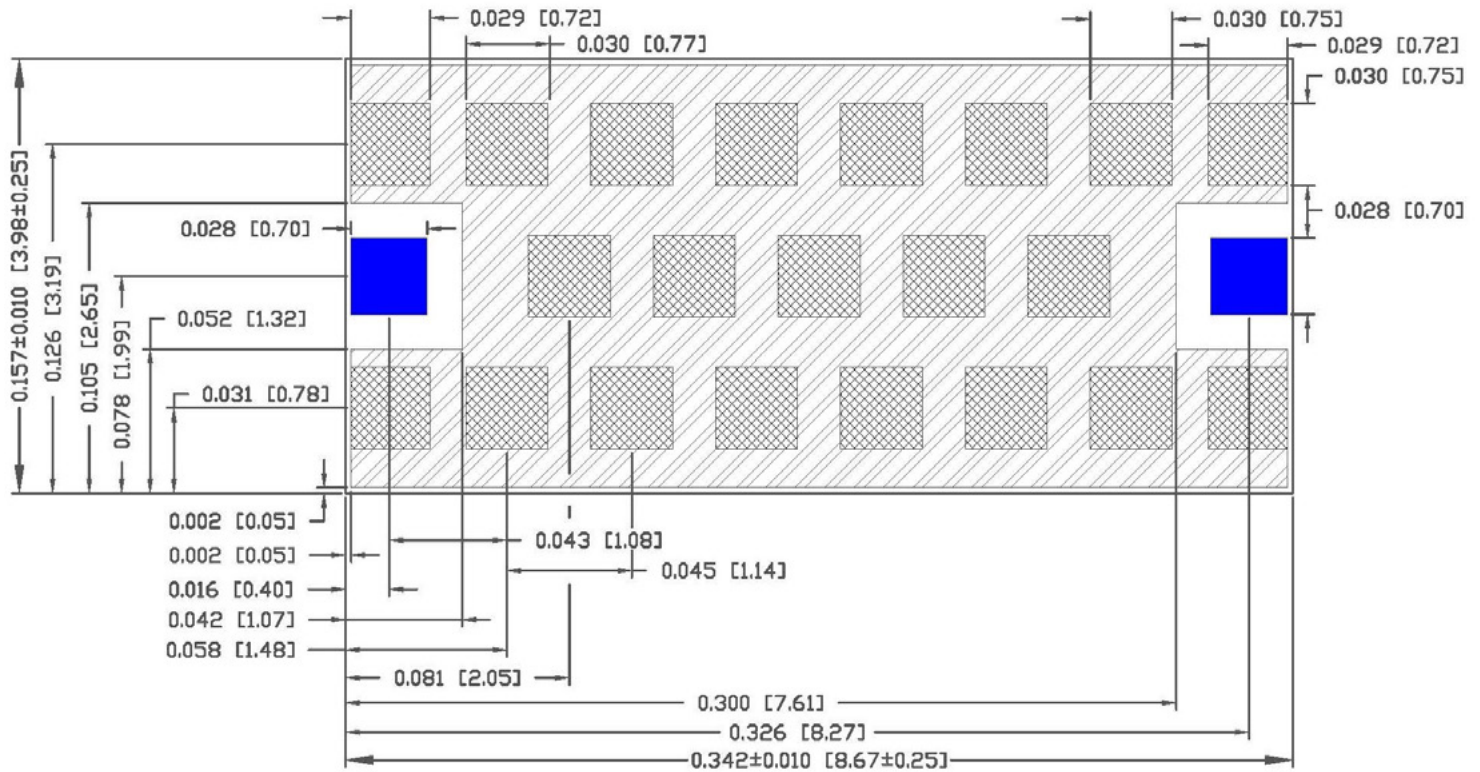

Input / output pads shown in Blue. Grounding pads shown in gray.

Dimensions in inches [mm]

Tolerances are +/-0.002 [0.05], unless noted.

Dimensions nominal unless otherwise noted.

All contact areas are gold plated, including I/O pads.

100 mil cavity height above device. Please contact factory if alternate clearance is needed

Multilayer Organic (MLO®) Filters

Mechanical Specifications, Pad Layout, and Mounting Recommendations

Footprint C

SUGGESTED PCB LAYOUT

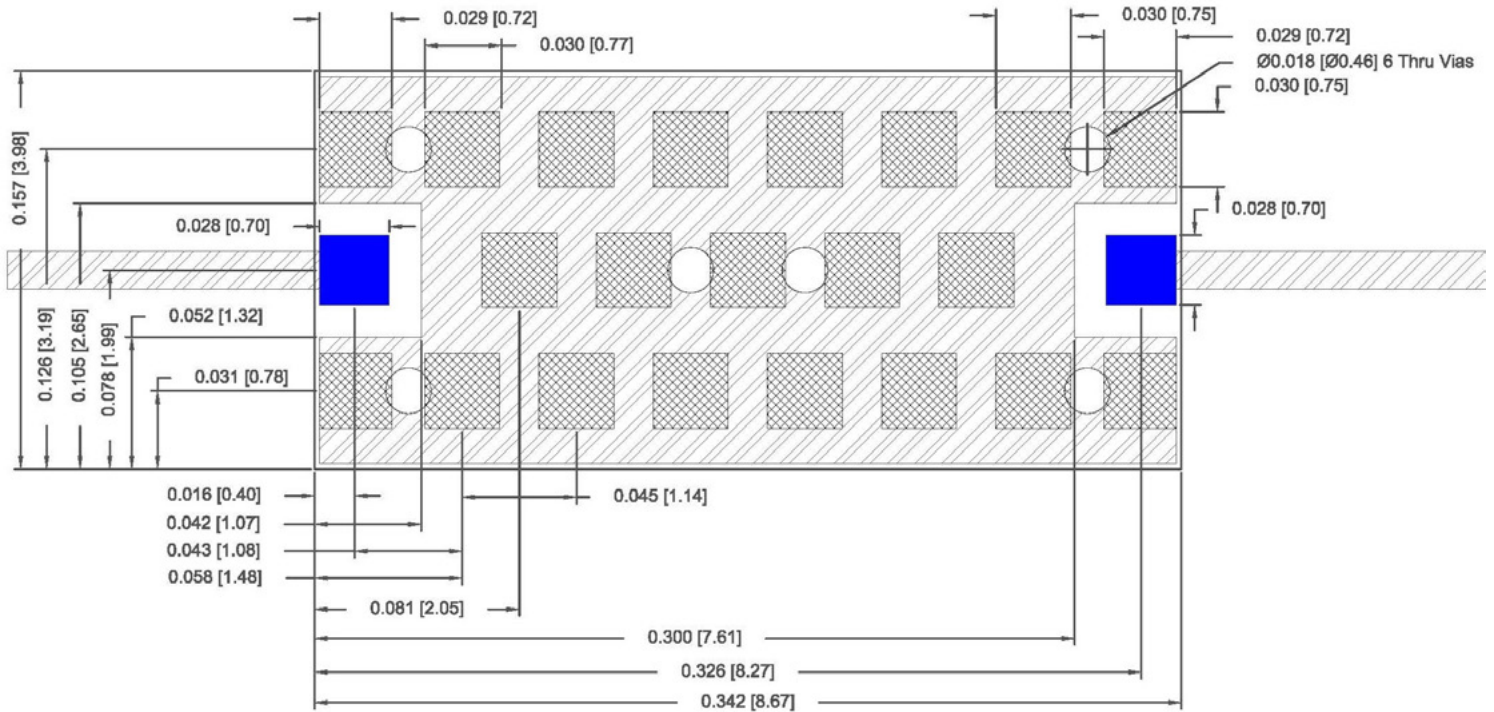

Dimensions in inches [mm].

Dimensions nominal unless otherwise noted.

Line width for I/O pads should be designed to match 50-ohm characteristic impedance, depending on PCB material and thickness. Grounding for these lines not shown.

Please see DXF file in part data package.

All contact areas are gold plated, including I/O pads.

Grounding is solid copper under solder mask, with solder mask defined pads for ground openings. I/O pads are not shorted to ground.

Multilayer Organic (MLO®) Filters

Mechanical Specifications, Pad Layout, and Mounting Recommendations

Footprint C



PAD CONNECTIONS

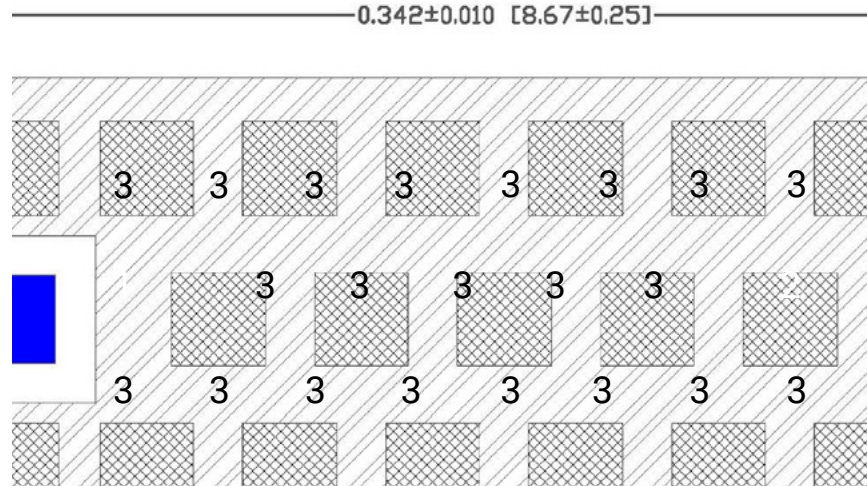

Pins 1 & 2 are input / output. Shown in Blue.
Pin 3 - grounding pads. Shown in gray.
Dimensions in inches [mm]

Multilayer Organic (MLO®) Filters

Mechanical Specifications, Pad Layout, and Mounting Recommendations

Footprint D



MECHANICAL SPECIFICATIONS

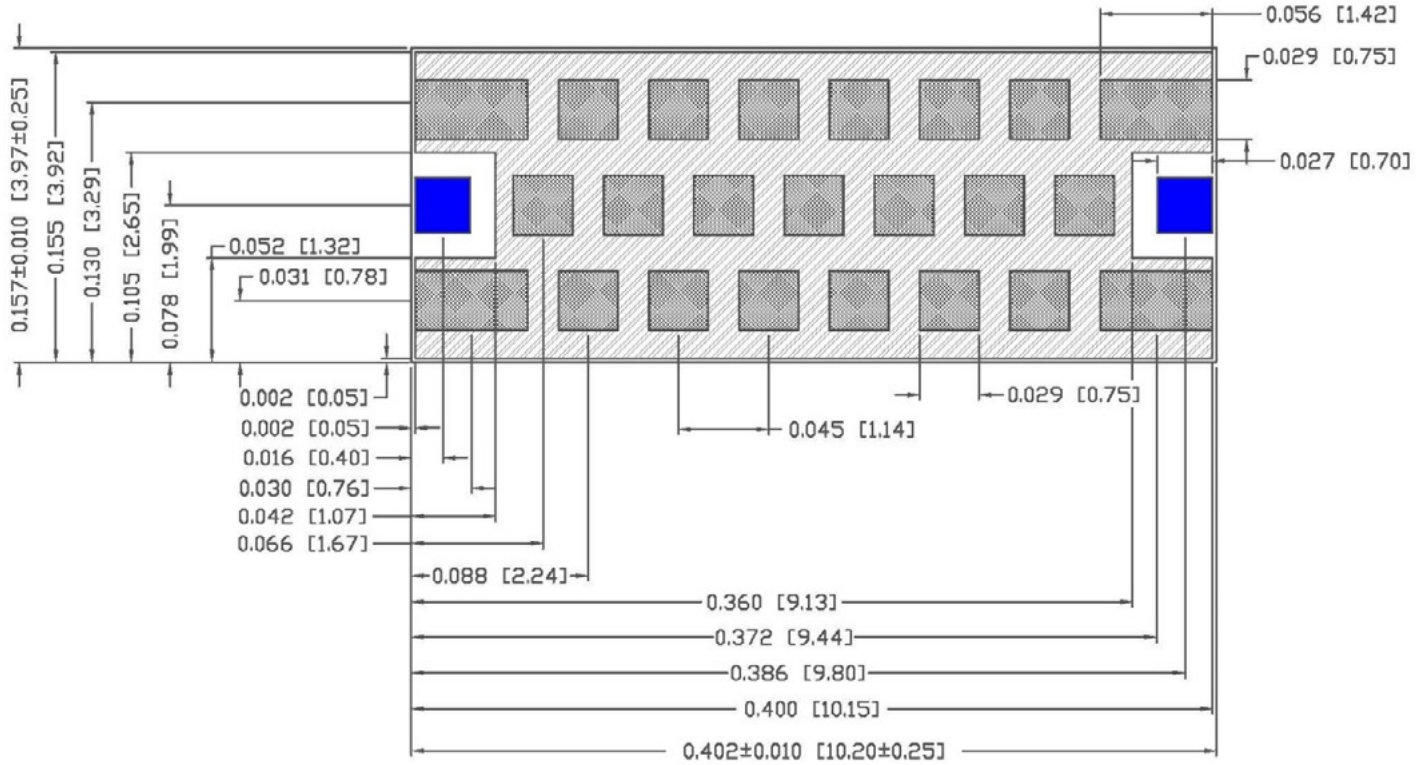

Input / output pads shown in Blue. Grounding pads shown in gray.

Dimensions in inches [mm]

Tolerances are +/-0.002 [0.05], unless noted.

Dimensions nominal unless otherwise noted.

All contact areas are gold plated, including I/O pads.

100 mil cavity height above device. Please contact factory if alternate clearance is needed

Multilayer Organic (MLO®) Filters

Mechanical Specifications, Pad Layout, and Mounting Recommendations

Footprint D



SUGGESTED PCB LAYOUT

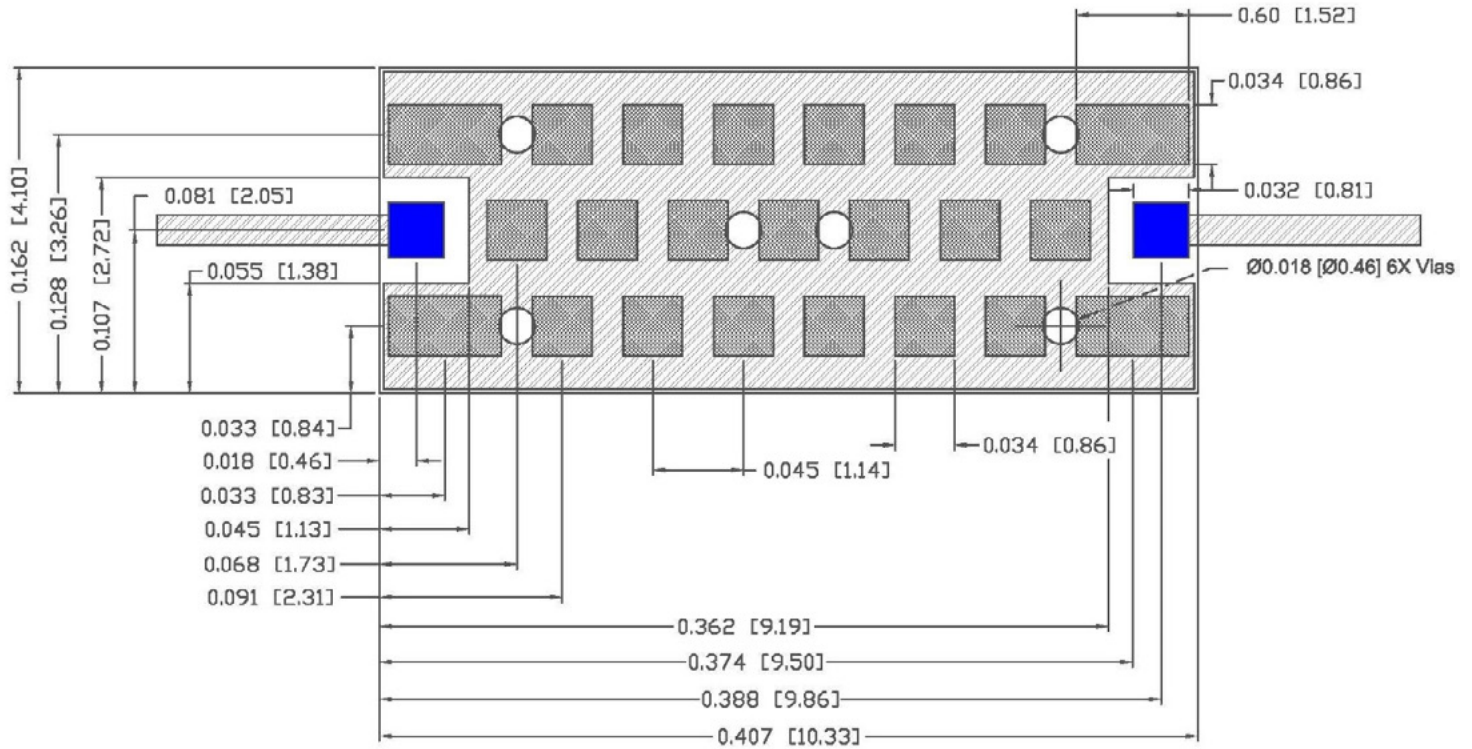

Dimensions in inches [mm].

Dimensions nominal unless otherwise noted.

Line width for I/O pads should be designed to match 50-ohm characteristic impedance, depending on PCB material and thickness. Grounding for these lines not shown. Please see DXF file in part data package.

All contact areas are gold plated, including I/O pads.

Grounding is solid copper under solder mask, with solder mask defined pads for ground openings. I/O pads are not shorted to ground.

Multilayer Organic (MLO®) Filters

Mechanical Specifications, Pad Layout, and Mounting Recommendations

Footprint D

PAD CONNECTIONS

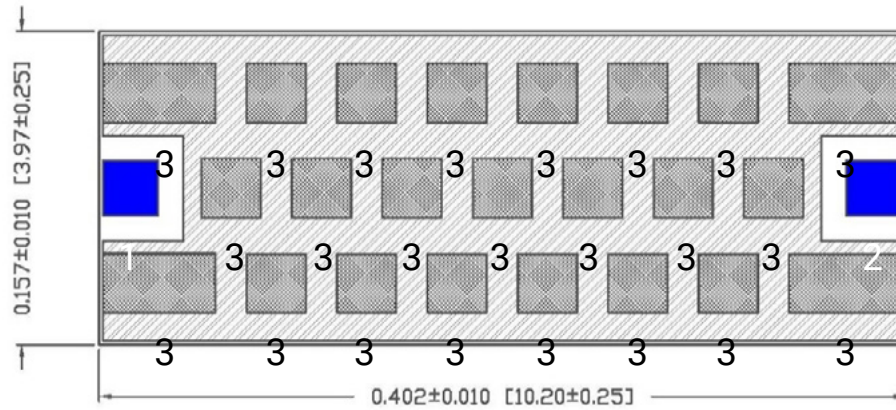

Pins 1 & 2 are input / output. Shown in Blue.
Pin 3 - grounding pads. Shown in gray.
Dimensions in inches [mm]

Multilayer Organic (MLO®) Filters

Mechanical Specifications, Pad Layout, and Mounting Recommendations

Footprint E



MECHANICAL SPECIFICATIONS

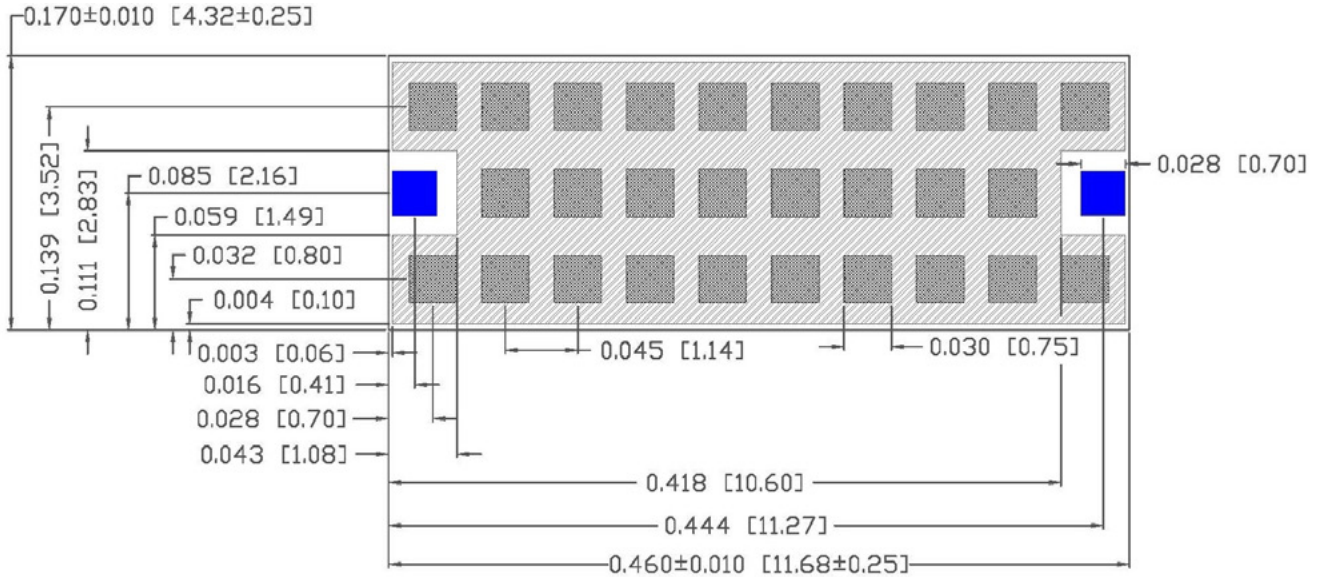

Input / output pads shown in Blue. Grounding pads shown in gray.
 Dimensions in inches [mm]
 Tolerances are +/-0.002 [0.05], unless noted.
 Dimensions nominal unless otherwise noted.
 All contact areas are gold plated, including I/O pads.
 100 mil cavity height above device. Please contact factory if alternate clearance is needed

Multilayer Organic (MLO®) Filters

Mechanical Specifications, Pad Layout, and Mounting Recommendations

Footprint E

SUGGESTED PCB LAYOUT

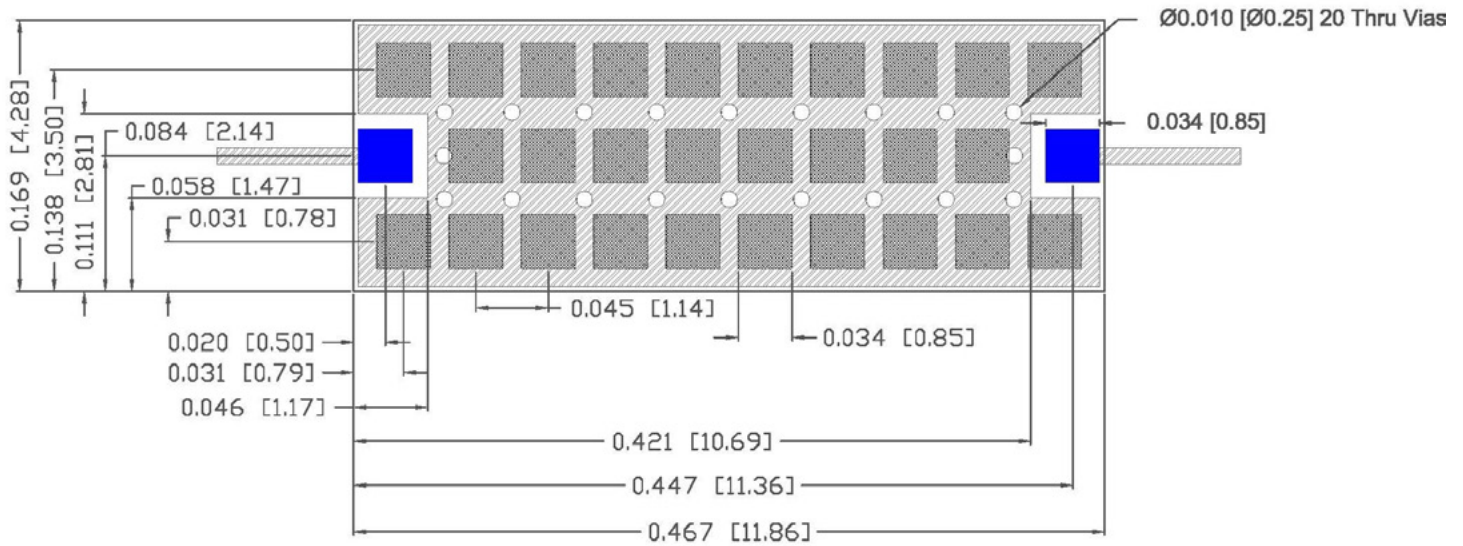

Dimensions in inches [mm].

Dimensions nominal unless otherwise noted.

Line width for I/O pads should be designed to match 50-ohm characteristic impedance, depending on PCB material and thickness. Grounding for these lines not shown. Please see DXF file in part data package.

All contact areas are gold plated, including I/O pads.

Grounding is solid copper under solder mask, with solder mask defined pads for ground openings. I/O pads are not shorted to ground.

Multilayer Organic (MLO®) Filters

Mechanical Specifications, Pad Layout, and Mounting Recommendations

Footprint E



PAD CONNECTIONS

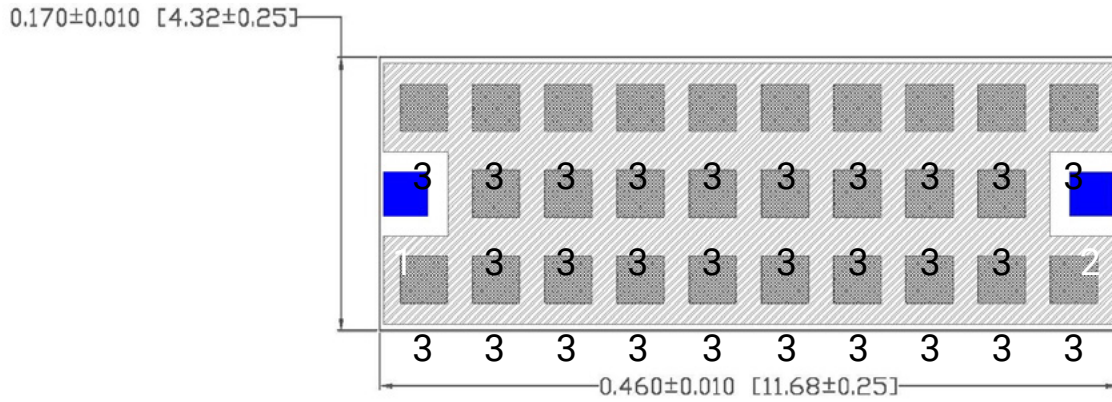

Pins 1 & 2 are input / output. Shown in Blue.
 Pin 3 - grounding pads. Shown in gray.
 Dimensions in inches [mm]

Multilayer Organic (MLO®) Filters

Mechanical Specifications, Pad Layout, and Mounting Recommendations

Footprint E1



MECHANICAL SPECIFICATIONS

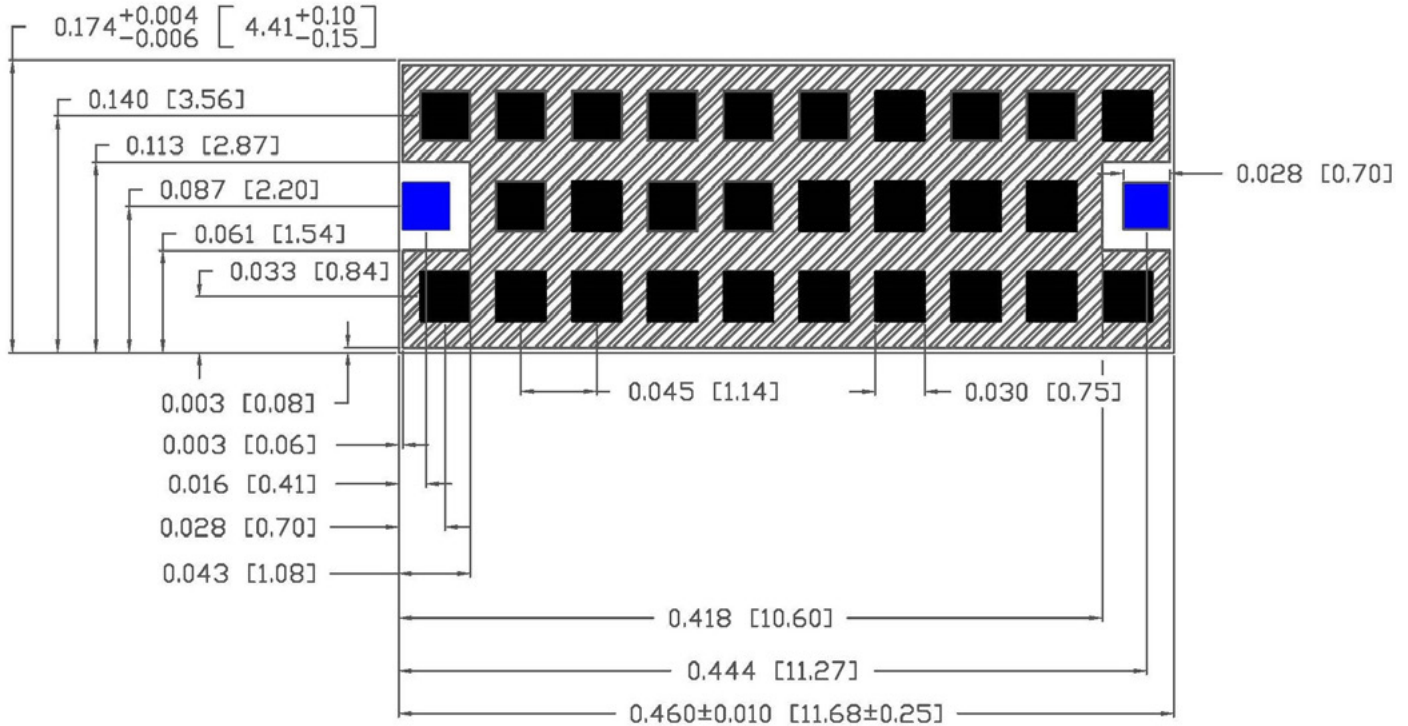

Input / output pads shown in Blue. Grounding pads shown in black.

Dimensions in inches [mm]

Tolerances are +/-0.002 [0.05], unless noted.

Dimensions nominal unless otherwise noted.

All contact areas are gold plated, including I/O pads.

100 mil cavity height above device. Please contact factory if alternate clearance is needed

Multilayer Organic (MLO®) Filters

Mechanical Specifications, Pad Layout, and Mounting Recommendations

Footprint E1



SUGGESTED PCB LAYOUT

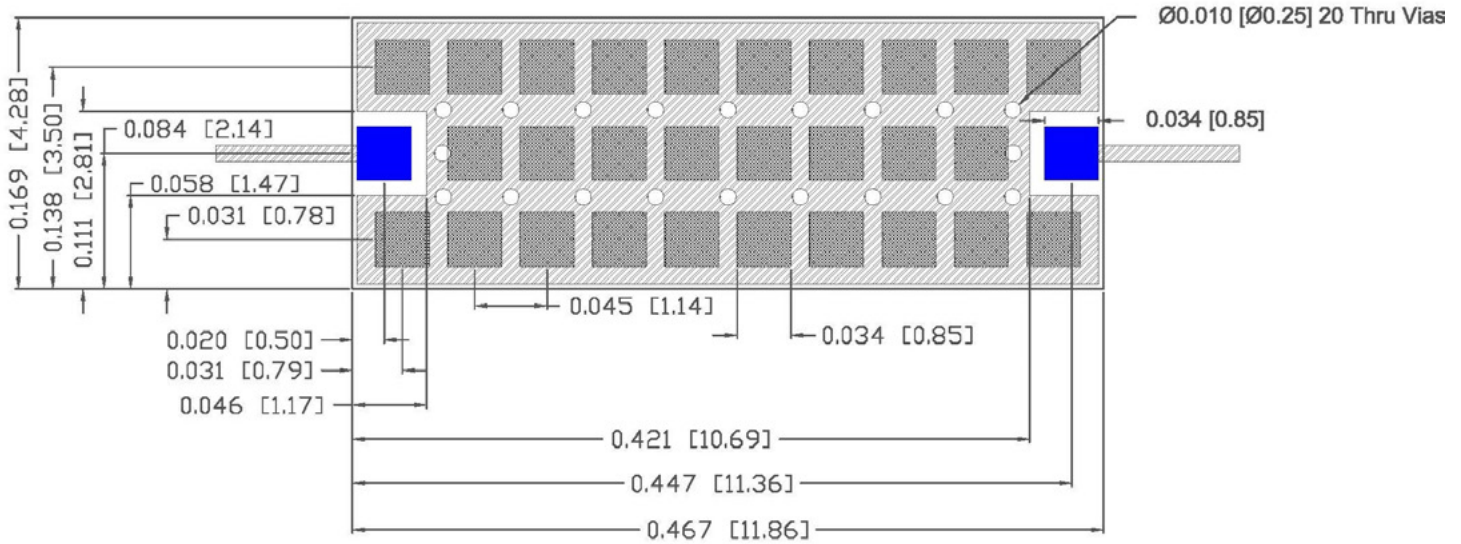

Dimensions in inches [mm].

Dimensions nominal unless otherwise noted.

Line width for I/O pads should be designed to match 50-ohm characteristic impedance, depending on PCB material and thickness. Grounding for these lines not shown.

Please see DXF file in part data package.

All contact areas are gold plated, including I/O pads.

Grounding is solid copper under solder mask, with solder mask defined pads for ground openings. I/O pads are not shorted to ground.

Multilayer Organic (MLO®) Filters

Mechanical Specifications, Pad Layout, and Mounting Recommendations

Footprint E1

PAD CONNECTIONS

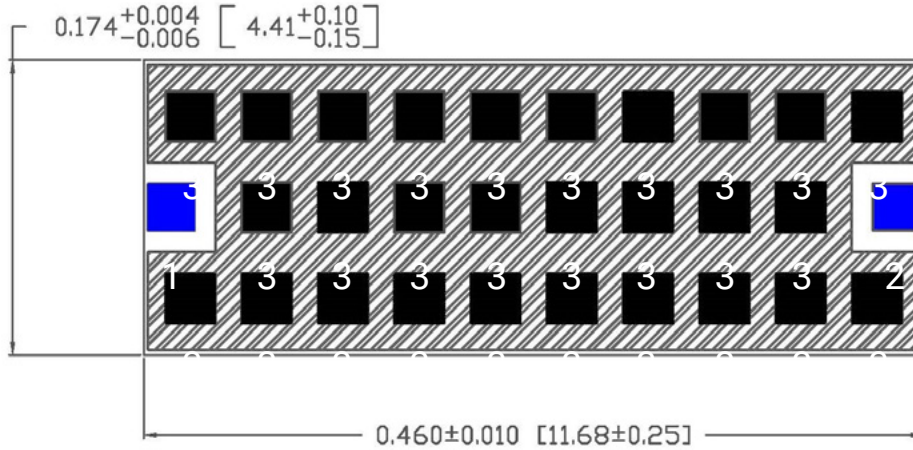

Pins 1 & 2 are input / output. Shown in Blue.
 Pin 3 - grounding pads. Shown in black.
 Dimensions in inches [mm]

Multilayer Organic (MLO®) Filters

Mechanical Specifications, Pad Layout, and Mounting Recommendations

Footprint E2



MECHANICAL SPECIFICATIONS

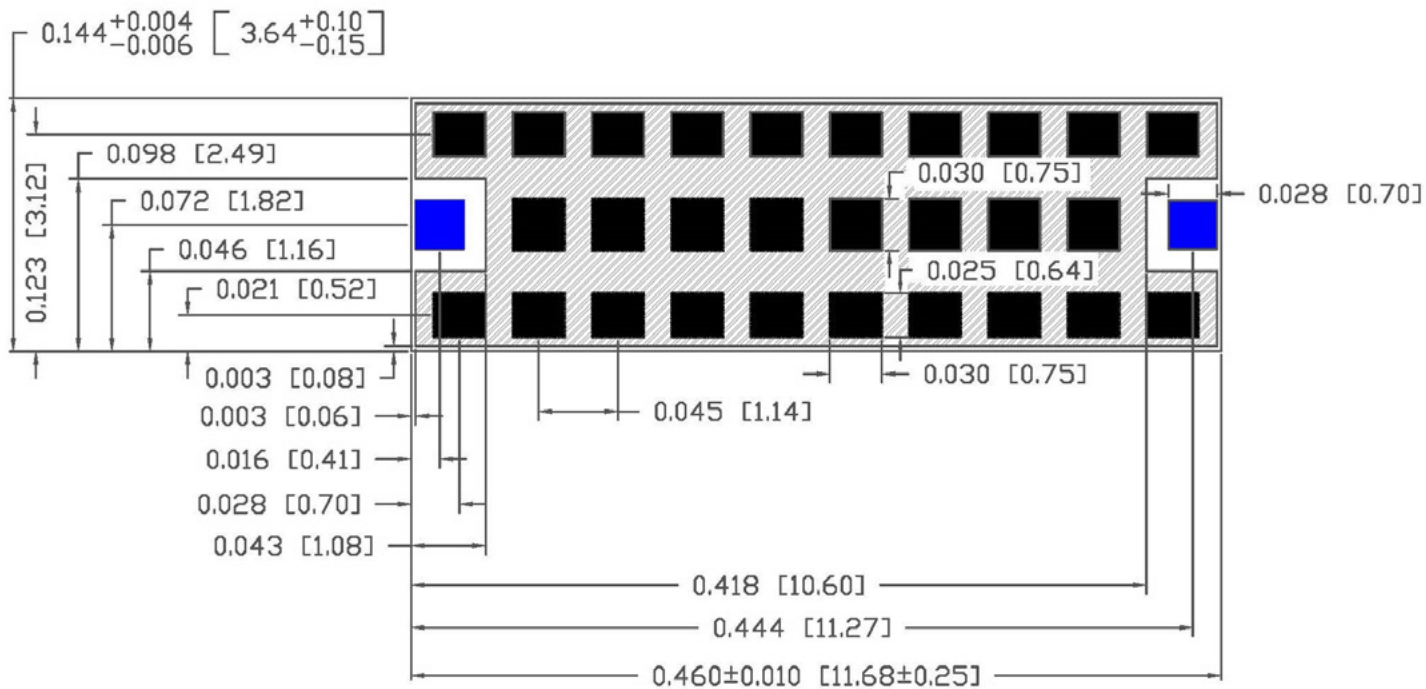

Input / output pads shown in Blue. Grounding pads shown in black.

Dimensions in inches [mm]

Tolerances are +/-0.002 [0.05], unless noted.

Dimensions nominal unless otherwise noted.

All contact areas are gold plated, including I/O pads.

100 mil cavity height above device. Please contact factory if alternate clearance is needed

Multilayer Organic (MLO®) Filters

Mechanical Specifications, Pad Layout, and Mounting Recommendations

Footprint E2

SUGGESTED PCB LAYOUT

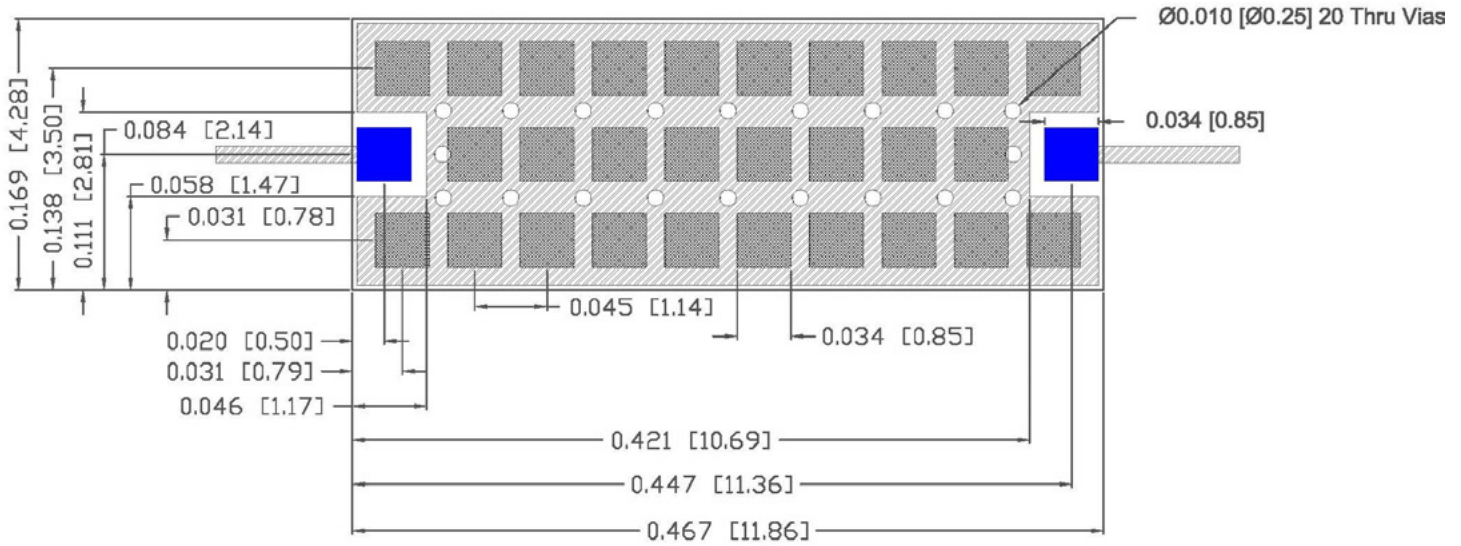

Dimensions in inches [mm].

Dimensions nominal unless otherwise noted.

Line width for I/O pads should be designed to match 50-ohm characteristic impedance, depending on PCB material and thickness. Grounding for these lines not shown. Please see DXF file in part data package.

All contact areas are gold plated, including I/O pads.

Grounding is solid copper under solder mask, with solder mask defined pads for ground openings. I/O pads are not shorted to ground.

Multilayer Organic (MLO®) Filters

Mechanical Specifications, Pad Layout, and Mounting Recommendations

Footprint E2

PAD CONNECTIONS

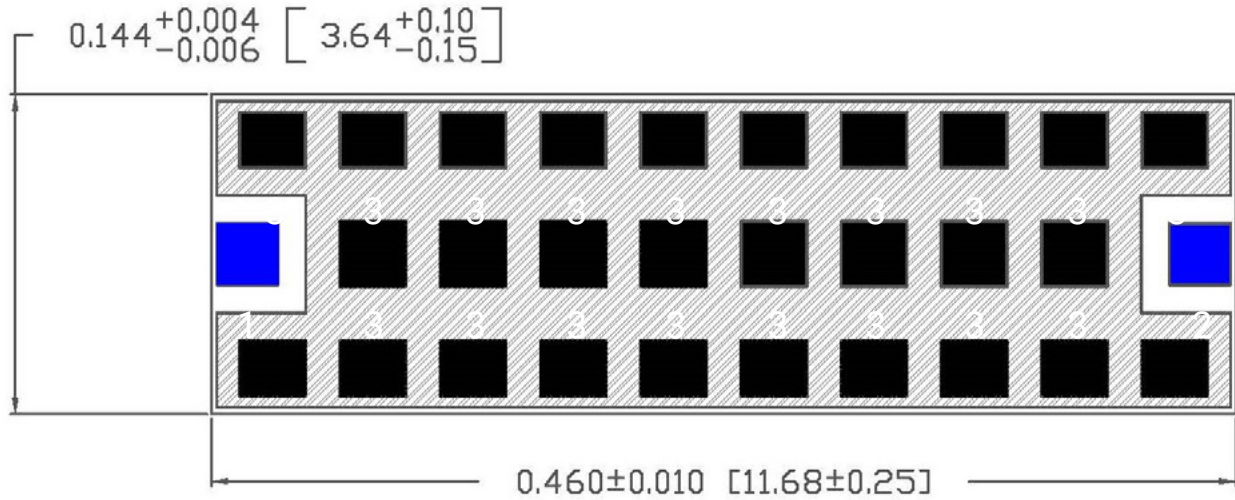

Pins 1 & 2 are input / output. Shown in Blue.
Pin 3 - grounding pads. Shown in Black.
Dimensions in inches [mm]

Multilayer Organic (MLO®) Filters

Mechanical Specifications, Pad Layout, and Mounting Recommendations

Footprint F



MECHANICAL SPECIFICATIONS

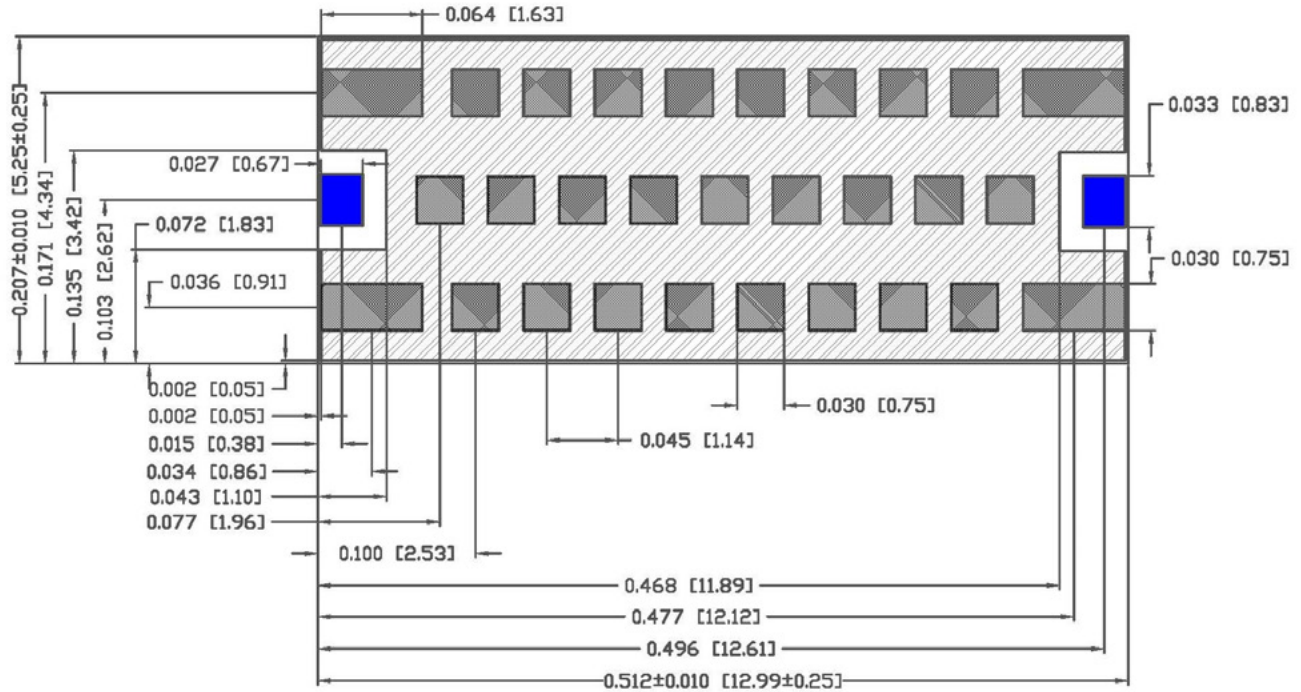

Input / output pads shown in Blue. Grounding pads shown in gray.

Dimensions in inches [mm]

Tolerances are +/-0.002 [0.05], unless noted.

Dimensions nominal unless otherwise noted.

All contact areas are gold plated, including I/O pads.

100 mil cavity height above device. Please contact factory if alternate clearance is needed

Multilayer Organic (MLO®) Filters

Mechanical Specifications, Pad Layout, and Mounting Recommendations

Footprint F



SUGGESTED PCB LAYOUT

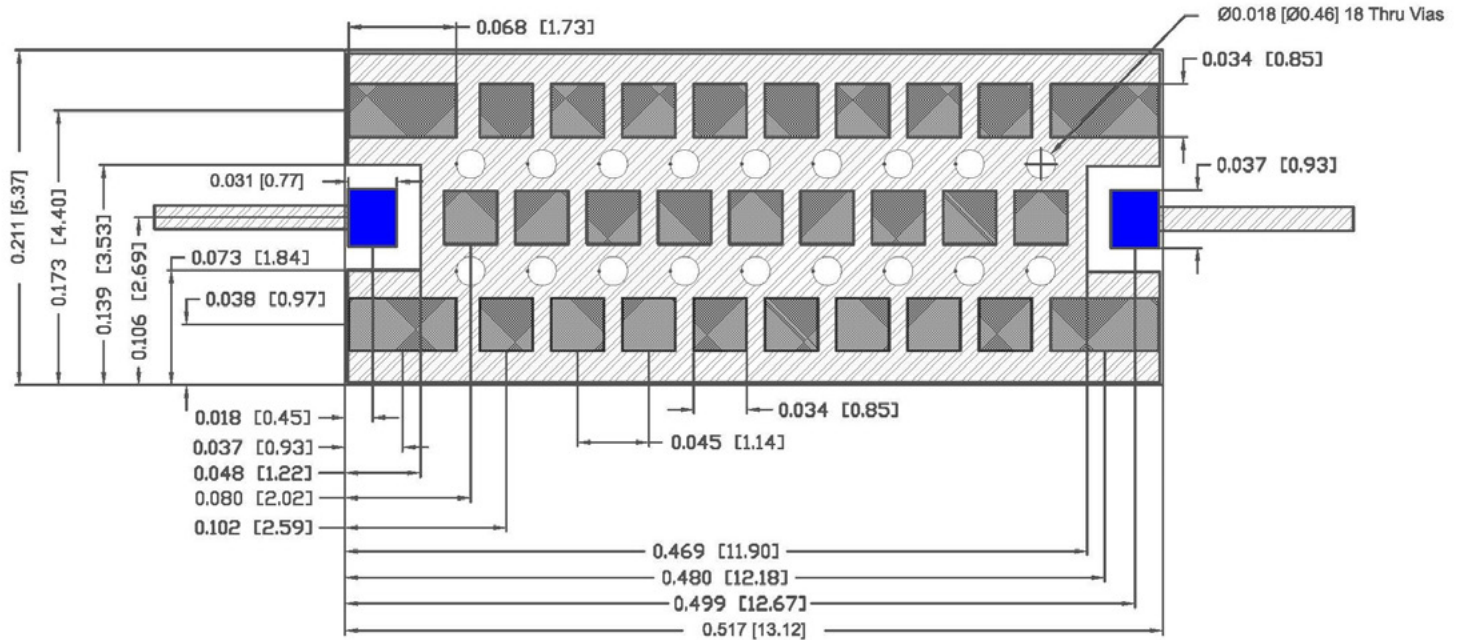

Dimensions in inches [mm].

Dimensions nominal unless otherwise noted.

Line width for I/O pads should be designed to match 50-ohm characteristic impedance, depending on PCB material and thickness. Grounding for these lines not shown. Please see DXF file in part data package.

All contact areas are gold plated, including I/O pads.

Grounding is solid copper under solder mask, with solder mask defined pads for ground openings. I/O pads are not shorted to ground.

Multilayer Organic (MLO®) Filters

Mechanical Specifications, Pad Layout, and Mounting Recommendations

Footprint F

PAD CONNECTIONS

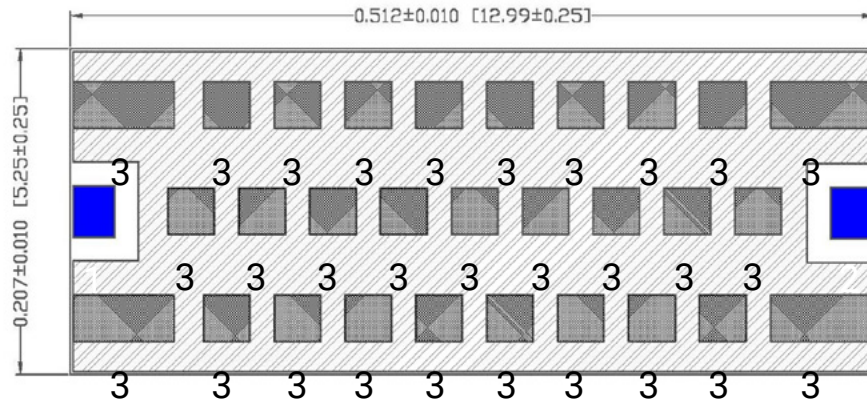

Pins 1 & 2 are input / output. Shown in Blue.
Pin 3 - grounding pads. Shown in gray.
Dimensions in inches [mm]

Multilayer Organic (MLO®) Filters

Mechanical Specifications, Pad Layout, and Mounting Recommendations



MOUNTING RECOMMENDATIONS

AUTOMATED SMT ASSEMBLY

The following section describes the guidelines for automated SMT assembly of MLO® RF devices which are typically Land Grid Array (LGA) packages or side termination SMT packages.

Control of solder and solder paste volume is critical for surface mount assembly of MLO® RF devices onto the PCB.

Stencil thickness and aperture openings should be adjusted according to the optimal solder volume. The following are general recommendations for SMT mounting of MLO® devices onto the PCB.

SMT REFLOW PROFILE

Common IR or convection reflow SMT processes shall be used for the assembly. Standard SMT reflow profiles, for eutectic and Pb free solders, can be used to surface mount the MLO® devices onto the PCB. In all cases, a temperature gradient of 3°C/sec, or less, should be maintained to prevent warpage of the package and to ensure that all joints reflow properly. Additional soak time and slower preheating time may be required

to improve the out-gassing of solder paste. In addition, the reflow profile depends on the PCB density and the type of solder paste used. Standard no-clean solder paste is generally recommended. If another type of flux is used, complete removal of flux residual may be necessary. Example of a typical lead free reflow profile is shown below.

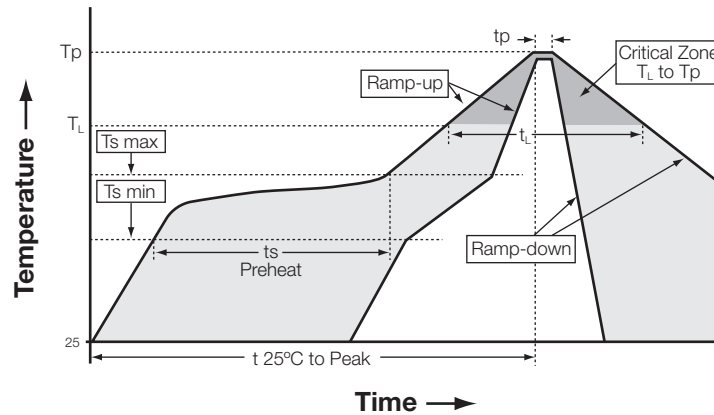

Figure A. Typical Lead Free Profile and Parameters

Profile Parameter	Pb free, Convection, IR/Convection
Ramp-up rate (Tsmax to Tp)	3°C/second max.
Preheat temperature (Ts min to Ts max)	150°C to 200°C
Preheat time (ts)	60 – 180 seconds
Time above TL, 217°C (t _L)	60 – 120 seconds
Peak temperature (Tp)	260°C
Time within 5°C of peak temperature (tp)	10 – 20 seconds
Ramp-down rate	4°C/second max.
Time 25°C to peak temperature	6 minutes max.

Multilayer Organic (MLO®) Capacitors

General Information



GENERAL DESCRIPTION

Based on its patented multilayer low loss organic (MLO®) technology. These new capacitors represent a paradigm shift from traditional ceramic and thin film passive SMD components. Multilayer Organic Capacitors (MLOC) are polymer based capacitors that use high conductivity copper interconnects in a multilayer fashion. The ability to fabricate these components on large area substrates and state of the art laser direct imaging allow for improved cost benefits and tolerance control. The end result is a state of the art low ESR and high SRF low profile RF capacitor that can support frequencies well above one GHz. Additionally MLOCs are expansion matched to printed circuit boards to allow for improved reliability.

FEATURES

- Low ESR
- Hi-Q®
- High Self Resonance
- Tight Tolerance
- Low Dielectric Absorption (0.0015%)

APPLICATIONS

- RF Power Amplifiers
- Low Noise Amplifiers
- Filter Networks
- Instrumentation

HOW TO ORDER

ML	03	7	1	1R8	P	A	P	2A
Style	Case Size 03 = 0603	Voltage Code 5 = 50V V = 250V	Temperature Coefficient Code 1 = 0±30ppm	Capacitance EIA Capacitance Code in pF. First two digits = significant figures or "R" for decimal place. Third digit = number of zeros or after "R" significant figures.	Capacitance Tolerance Code P = ± 0.02 pF A = ± .05 pF B = ±.10 pF C = ±.25 pF D = ±.5 pF F = ±1% G = ±2% J = ±5%	Failure Rate Code A = Not Applicable	Termination Style Code T = Ni, Sn	Packaging Code 2A = 7" Reel Unmarked

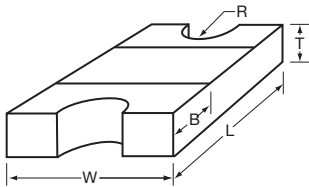

MECHANICAL DIMENSIONS: inches (millimeters)

Case	Length (L)	Width (W)	Thickness (T)	Band Width (B)	Castellation Radius (R)
0603	0.063 ± 0.004 (1.600 ± 0.102)	0.033 ± 0.004 (0.838 ± 0.102)	0.025 ± 0.004 (0.635 ± 0.102)	0.015 ± 0.005 (0.381 ± 0.127)	0.008 ± 0.002 (0.203 ± 0.051)

TAPE & REEL: All tape and reel specifications are in compliance with EIA RS481 (equivalent to IEC 286 part 3).

- 8mm carrier
- 7" reel, 3,000 pcs per reel

Multilayer Organic (MLO®) Capacitors

Mechanical & Environmental Specifications

ENVIRONMENTAL CHARACTERISTICS

TEST	CONDITIONS	REQUIREMENT
Life (Endurance) MIL-STD-202F Method 108A	125°C, 2UR, 1000 hours	No visible damage $\Delta C/C \leq 2\%$ for $C \geq 5pF$ $\Delta C/C \leq 0.25pF$ for $C < 5pF$
Accelerated Damp Heat Steady State MIL-STD-202F Method 103B	85°C, 85% RH, UR, 1000 hours	No visible damage $\Delta C/C \leq 2\%$ for $C \geq 5pF$ $\Delta C/C \leq 0.25pF$ for $C < 5pF$
Temperature Cycling MIL-STD-202F Method 107E MIL-STD-883D Method 1010.7	-55°C to +125°C, 15 cycles – MLO®	No visible damage $\Delta C/C \leq 2\%$ for $C \geq 5pF$ $\Delta C/C \leq 0.25pF$ for $C < 5pF$
Resistance to Solder Heat IEC-68-2-58	260°C \pm 5°C for 10 secs.	C remains within initial limits

MECHANICAL SPECIFICATIONS

TEST	CONDITIONS	REQUIREMENT
Solderability IEC-68-2-58	Components completely immersed in a solder bath at 235°C for 2 secs.	Terminations to be well tinned, minimum 95% coverage
Leach Resistance IEC-68-2-58	Components completely immersed in a solder bath at 260 \pm 5°C for 60 secs.	Dissolution of termination faces $\leq 15\%$ of area Dissolution of termination edges $\leq 25\%$ of length
Adhesion MIL-STD-202F Method 211A	A force of 5N applied for 10 secs.	No visible damage
Termination Bond Strength IEC-68-2-21 Amend. 2	Tested as shown in diagram	No visible damage $C/C \leq 2\%$ for $C \geq 5pF$ $\Delta C/C \leq 0.25pF$ for $C < 5pF$
Robustness of Termination IEC-68-2-21 Amend. 2	A force of 5N applied for 10 secs.	No visible damage
Storage	12 months minimum with components stored in "as received" packaging	Good solderability

QUALITY & RELIABILITY

MLO® capacitors utilize high density interconnect wiring technology on well established low loss organic materials.

FINAL QUALITY INSPECTION

Finished parts are tested for standard electrical parameters and visual/mechanical characteristics. Each production lot is 100% evaluated for: capacitance and proof voltage at 2.5 U_R . In addition, production is periodically evaluated for:

- Average capacitance with histogram printout for capacitance distribution;
- IR and Breakdown Voltage distribution;
- Temperature Coefficient;
- Solderability;
- Dimensional, mechanical and temperature stability.

QUALITY ASSURANCE

The reliability of these multilayer organic capacitors has been extensively

studied. Various methods and standards have been used to ensure a high quality component including JEDEC, Mil Spec and IPC testing. KYOCERA AVX quality assurance policy is based on well established international industry standards. The reliability of the capacitors is determined by accelerated testing under the following conditions:

Life (Endurance)	125°C, 2U _R , 1000 hours
Accelerated Damp Heat Steady State	85°C, 85% RH, U _R , 1000 hours.

TABLE I: CASE SIZE ML03

Cap. pF	Cap. Tol.	WVDC	Cap. pF	Cap. Tol.	WVDC	Cap. pF	Cap. Tol.	WVDC
0.1	P, A, B	50, 250	1.3	P, A, B, C	50, 250	3.0	P, A, B, C	50, 250
0.2	P, A, B	50, 250	1.4	P, A, B, C	50, 250	3.3	P, A, B, C	50, 250
0.3	P, A, B	50, 250	1.5	P, A, B, C	50, 250	3.6	P, A, B, C	50, 250
0.4	P, A, B	50, 250	1.6	P, A, B, C	50, 250	3.9	P, A, B, C	50, 250
0.5	P, A, B, C	50, 250	1.7	P, A, B, C	50, 250			
0.6	P, A, B, C	50, 250	1.8	P, A, B, C	50, 250			
0.7	P, A, B, C	50, 250	1.9	P, A, B, C	50, 250			
0.8	P, A, B, C	50, 250	2.0	P, A, B, C	50, 250			
0.9	P, A, B, C	50, 250	2.2	P, A, B, C	50, 250			
1.0	P, A, B, C	50, 250	2.4	P, A, B, C	50, 250			
1.1	P, A, B, C	50, 250	2.5	P, A, B, C	50, 250			
1.2	P, A, B, C	50, 250	2.7	P, A, B, C	50, 250			

Note: Capacitance measured at 1MHz.

Typical ESR vs. Frequency
MLO® 0603

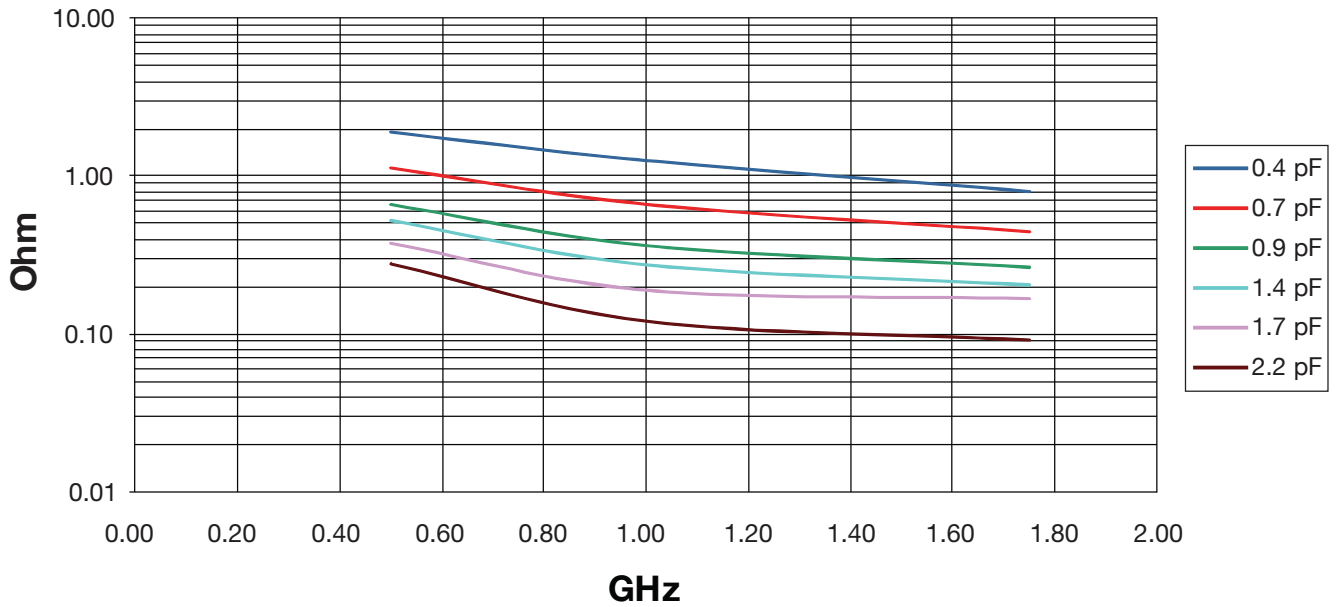

Typical Q vs. Frequency
MLO® 0603

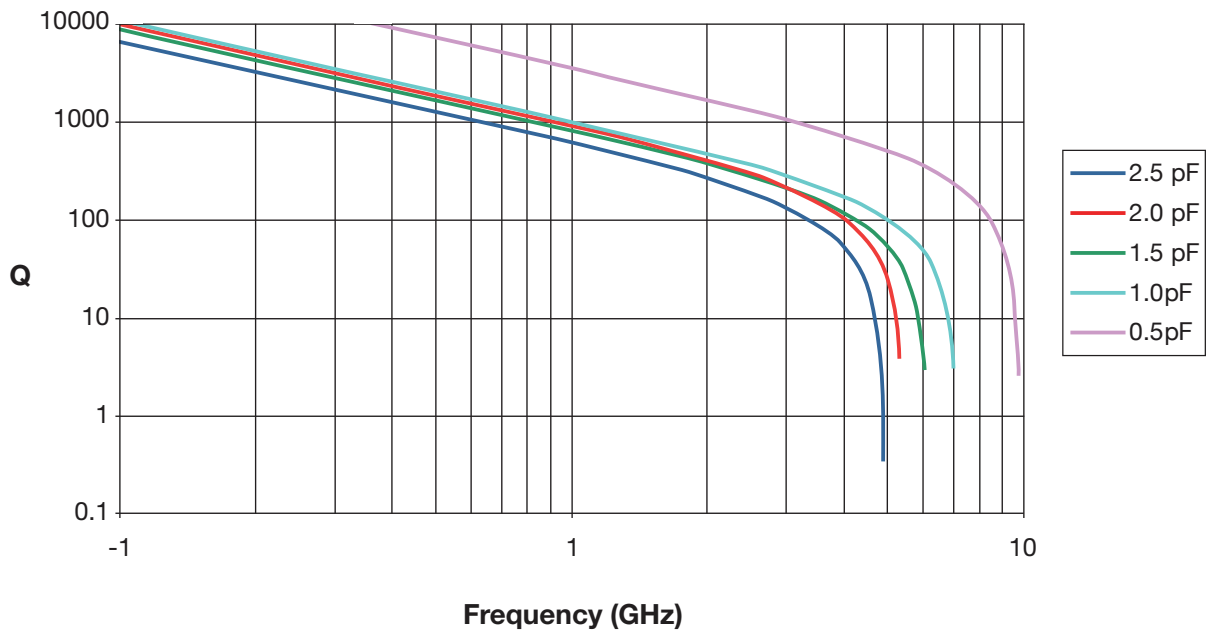

Typical Self Resonant Frequency vs. Capacitance
MLO® 0603

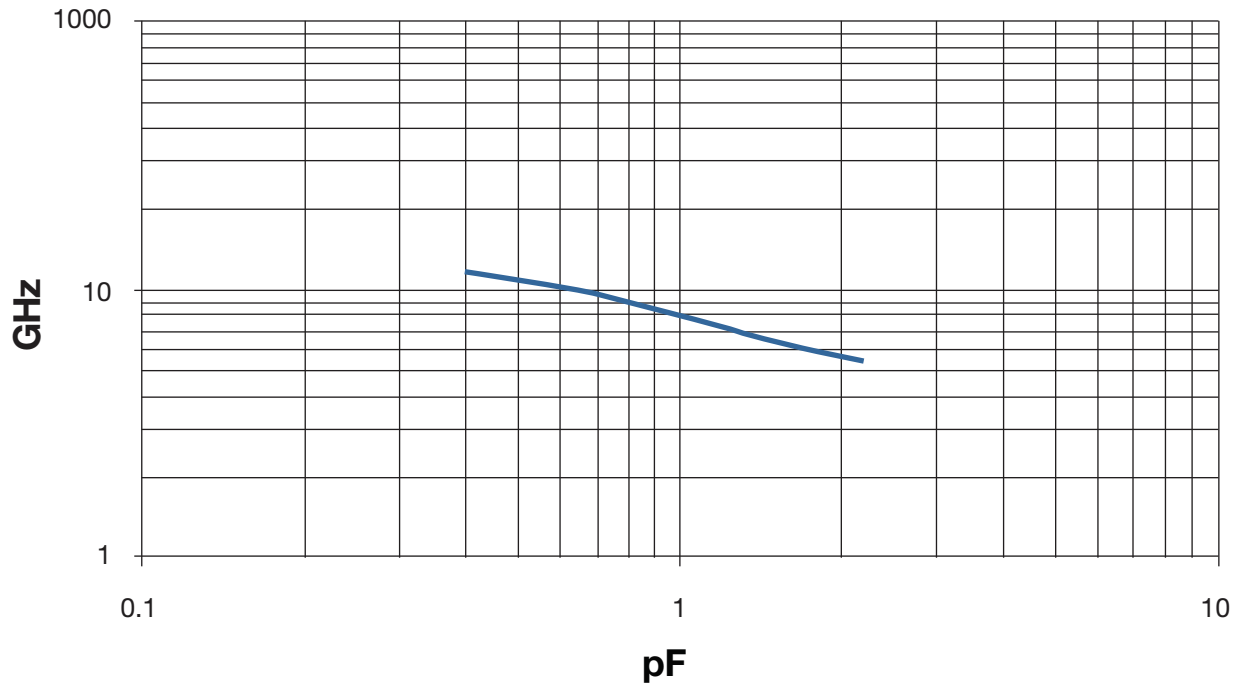

Multilayer Organic (MLO®) Diplexers

0603 WLAN/BT

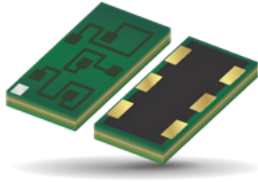

MLO® TECHNOLOGY

The 0603 diplexer is a best in class low profile multilayer organic passive device that is based on KYOCERA AVX patented multilayer organic high density interconnect technology. The MLO™ diplexer uses high dielectric constant and low loss materials to realize high Q passive printed elements such as inductors, and capacitors in a multilayer stack up. The MLO™ diplexers can support multiple wireless standards such as WCDMA, CDMA, WLAN, GSM, and BT. These diplexers are less than 0.5mm in height and are ideally suited for band switching for dual band systems. All diplexers are expansion matched to printed circuit boards thereby resulting in improved reliability vs. ceramic and Si components.

APPLICATIONS

- WiFi
- WiMax
- GPS
- Cellular Bands

LAND GRID ARRAY ADVANTAGES

- Inherent Low Profile
- Excellent Solderability
- Low Parasitics
- High Heat Dissipation

HOW TO ORDER

DP **03** **B** **5425** **7** **TR**

Type Size Design Frequency (MHz) Finish Packaging
 7 = Au
 T = NiSn
 Tape & Reel



COMPONENT DIMENSIONS AND FUNCTIONS

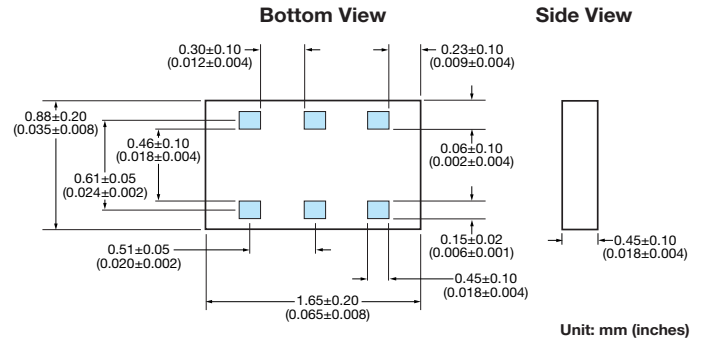

Terminal No.	Terminal Name
1	GND
2	Common
3	GND
4	Low Frequency Port
5	GND
6	High Frequency Port

PART NUMBER: DP03B54257TR

Electrical Characteristics @ 25°C

No.	Parameter	Freq. (MHz)	Port	Specification	Typ. value	Unit
1	Insertion Loss	2400-2496	Low	0.55 max	0.40	dB
2	Insertion Loss	4900-5950	High	1.2 max	0.80	dB
3	Attenuation	500-2700	High	28 min	35	dB
4	Attenuation	9800-11900	High	10 min	14	dB
6	Attenuation	4800-4992	Low	20 min	25	dB
7	Attenuation	4900-5950	Low	23 min	27	dB
8	Attenuation	7200-7500	Low	26 min	30	dB
9	Isolation	500-2700	Low-High	28 min	35	dB
10	Isolation	4900-5950	Low-High	22 min	25	dB
11	VSWR	2400-2500	Ant	2.0 max	1.5	-
12	VSWR	4900-5950	Ant	2.0 max	1.3	-
13	VSWR	2400-2500	Low	2.0 max	1.5	-
14	VSWR	4900-5950	High	2.0 max	1.3	-

ORIENTATION IN TAPE

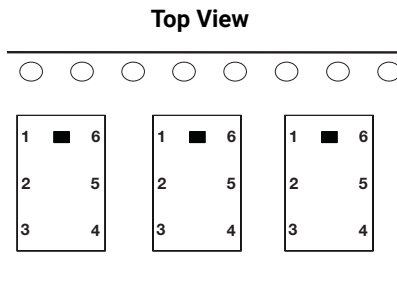

POWER CAPACITY

4.5W Maximum

Mechanical Characteristics @ 25°C

Size [mm(inches)]	1.65 x 0.88 (0.065 x 0.035)
Height [mm(inches)]	0.42 (0.017)
Volume (mm^3)	0.77

S PARAMETER MEASUREMENTS

LOW BAND PORT ATTENUATION

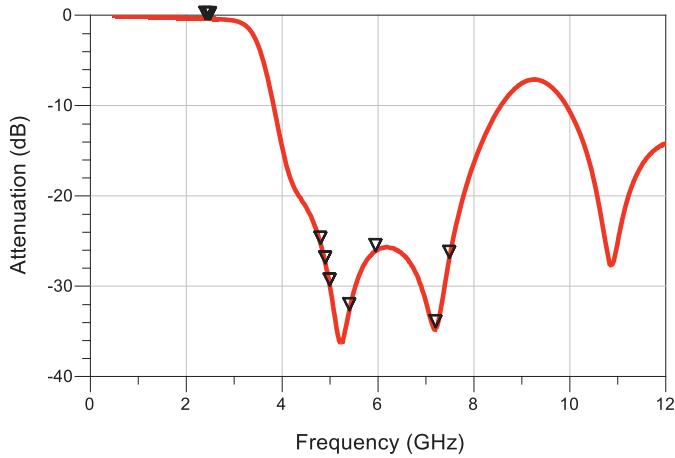

Low Band Attenuation

Frequency	Attenuation
4.800 GHz	25.302
4.992 GHz	29.935
4.900 GHz	27.471
5.400 GHz	32.647
5.590 GHz	26.099
7.200 GHz	34.531
7.488 GHz	26.860

HIGH BAND PORT ATTENUATION

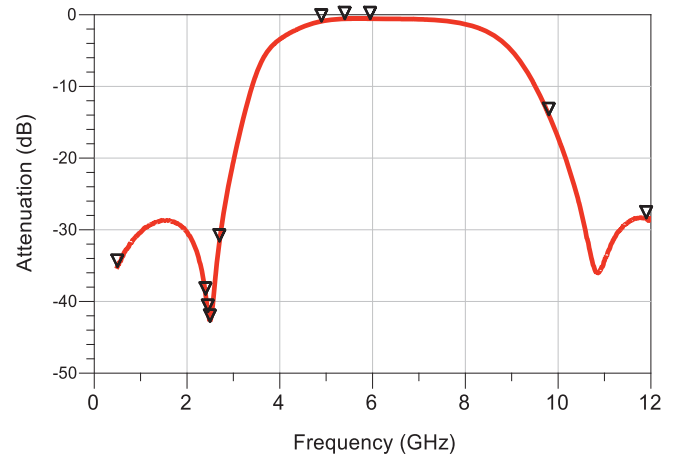

High Band Attenuation

Frequency	Attenuation
0.500 GHz	35.133
2.400 GHz	39.019
2.450 GHz	41.406
2.496 GHz	42.793
2.700 GHz	31.607
9.800 GHz	13.967
11.90 GHz	28.352

LOW BAND INSERTION LOSS

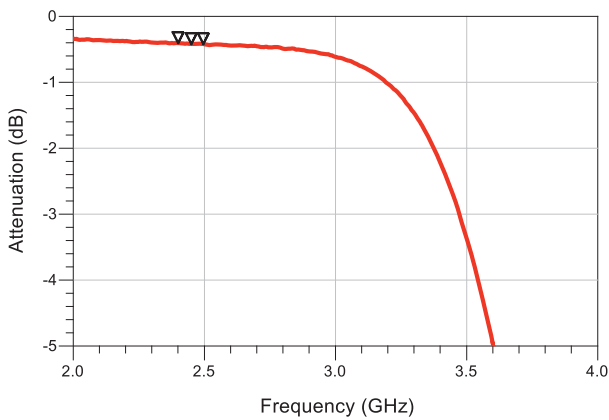

Low Band Insertion Loss

Frequency	Insertion Loss
2.400 GHz	0.404
2.450 GHz	0.418
2.496 GHz	0.420

HIGH BAND INSERTION LOSS

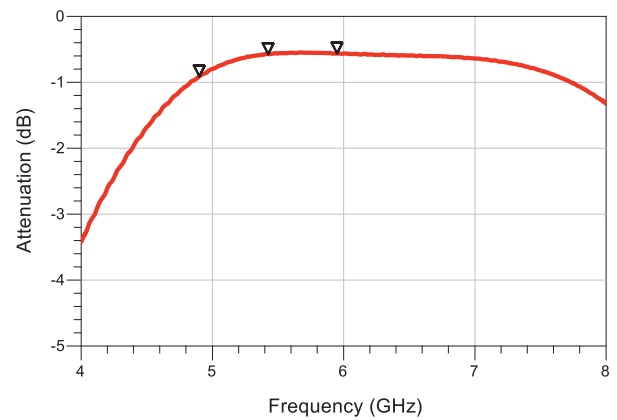

High Band Insertion Loss

Frequency	Insertion Loss
4.900 GHz	0.909
5.400 GHz	0.577
5.950 GHz	0.562

Multilayer Organic (MLO®) Diplexers

0603 WLAN/BT

S PARAMETER MEASUREMENTS

COMMON PORT RETURN LOSS

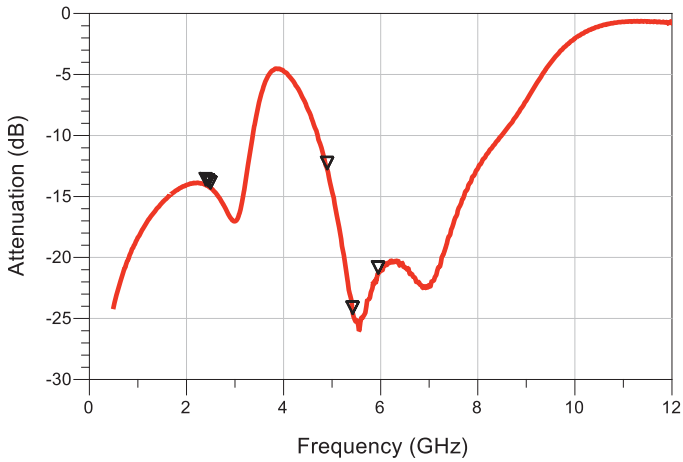

Common Return Loss

Frequency	Return Loss	VSWR
2.400 GHz	14.066	1.494
2.450 GHz	14.162	1.487
2.496 GHz	14.325	1.476
4.900 GHz	12.750	1.599
5.400 GHz	24.603	1.125
5.950 GHz	21.310	1.188

ISOLATION

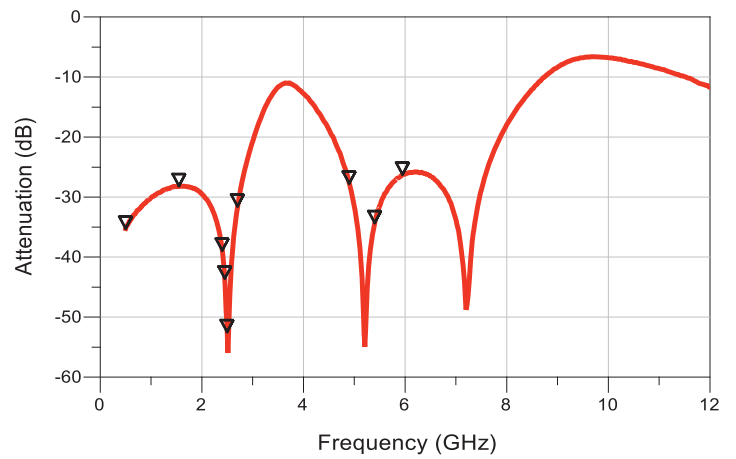

Isolation

Frequency	Attenuation
0.500 GHz	32.253
1.550 GHz	28.144
2.400 GHz	28.913
2.450 GHz	43.562
2.496 GHz	52.470
2.700 GHz	31.566
4.900 GHz	27.731
5.400 GHz	34.304
5.950 GHz	26.249

LOW BAND RETURN LOSS

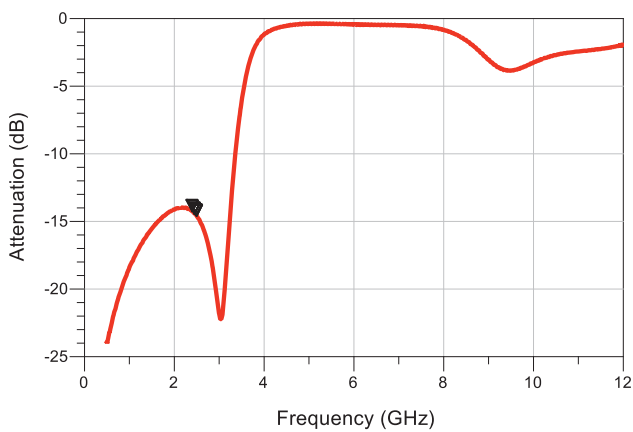

Low Band Return Loss

Frequency	Return Loss	VSWR
2.400 GHz	14.232	1.482
2.450 GHz	14.429	1.469
2.496 GHz	14.572	1.459

HIGH BAND RETURN LOSS

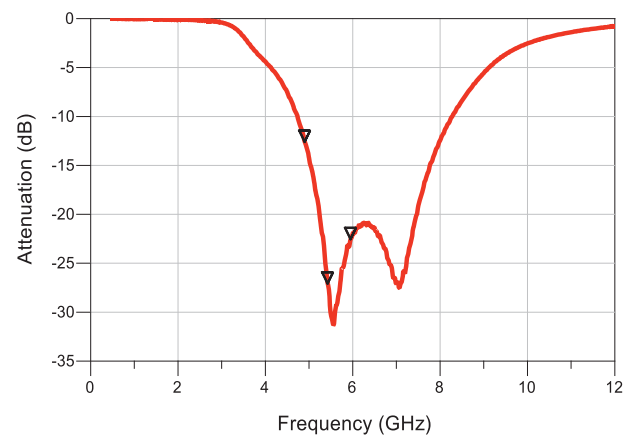

High Band Return Loss

Frequency	Return Loss	VSWR
4.900 GHz	12.587	
5.400 GHz	27.577	1.087
5.950 GHz	22.533	1.161

Multilayer Organic (MLO®) Diplexers

0805 CDMA

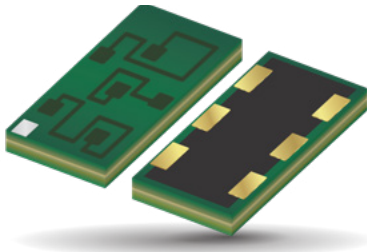

MLO® TECHNOLOGY

The 0603 diplexer is a best in class low profile multilayer organic passive device that is based on KYOCERA AVX patented multilayer organic high density interconnect technology. The MLO™ diplexer uses high dielectric constant and low loss materials to realize high Q passive printed elements such as inductors, and capacitors in a multilayer stack up. The MLO™ diplexers can support multiple wireless standards such as WCDMA, CDMA, WLAN, GSM, and BT. These diplexers are less than 0.5mm in height and are ideally suited for band switching for dual band systems. All diplexers are expansion matched to printed circuit boards thereby resulting in improved reliability vs. ceramic and Si components.

APPLICATIONS

Multiband applications including WCDMA, WLAN, WiMax, GPS, and cellular bands

LAND GRID ARRAY ADVANTAGES

- Low Insertion Loss
- Excellent Solderability
- Low Parasitics
- Low Profile

HOW TO ORDER

DP Type
05 Size
A Design
1920 Frequency (MHz)
7 Finish
 7 = Au
 T = NiSn
TR Packaging
 Tape & Reel
 TR = 3 Kpcs
 TR/500 = 500 pcs



QUALITY INSPECTION

Finished parts are 100% tested for electrical parameters and visual characteristics.

OPERATING TEMPERATURE

-40°C to +85°C

TERMINATION

Finishes available in Ni Au, Ni Sn and OSP coatings which are compatible with automatic soldering technologies which include reflow, wave soldering, vapor phase and manual.

ORIENTATION IN TAPE

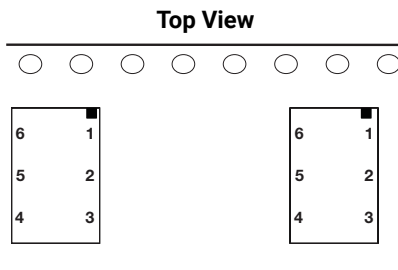

POWER CAPACITY

4.5W Maximum

COMPONENT DIMENSIONS AND FUNCTIONS

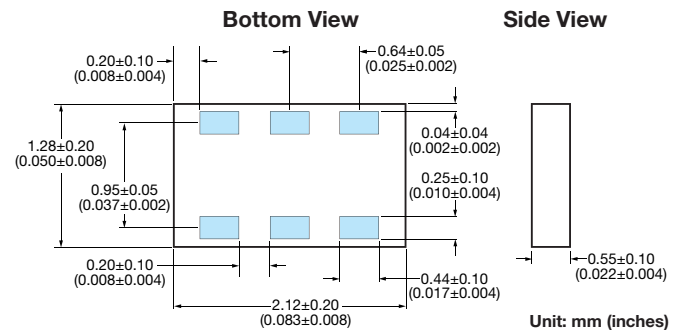

Terminal No.	Terminal Name
1	High Frequency Port
2	GND
3	Low Frequency Port
4	GND
5	Common Port
6	GND

PART NUMBER: DP05A19207TR

Specification @ 25°C	
Size [mm(inches)]	2.12 x 1.28 (0.083 x 0.050)
Height [mm(inches)]	0.55 (0.021)
Volume (mm³)	1.5
Frequency Range (F1) (MHz)	859±35
Frequency Range (F2) (MHz)	1920±70
Insertion Loss (F1, at Fc) (dB)	-0.4
Insertion Loss (F2, at Fc) (dB)	-0.6
Attenuation (F1) at (F2) (dB)	-23
Attenuation (F2) at (F1) (dB)	-23
VSWR (Input @ F1)	1.4
VSWR (Input @ F2)	1.3
VSWR (Lowband @ F1)	1.4
VSWR (Highband @ F2)	1.4

Multilayer Organic (MLO®) Diplexers

0805 CDMA

S PARAMETER MEASUREMENTS

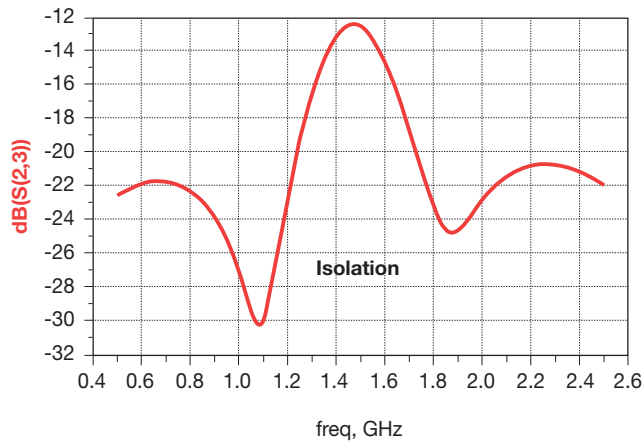
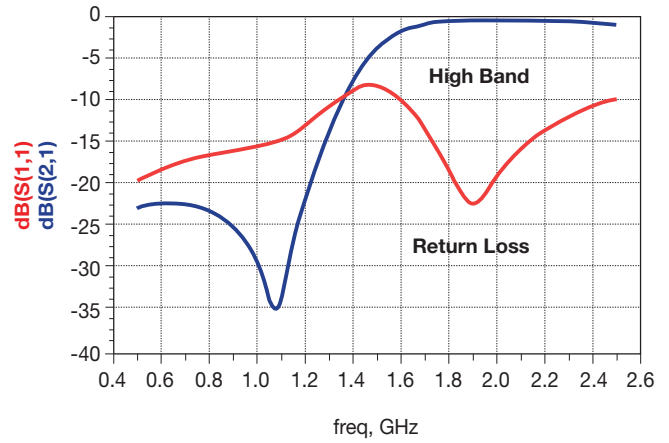
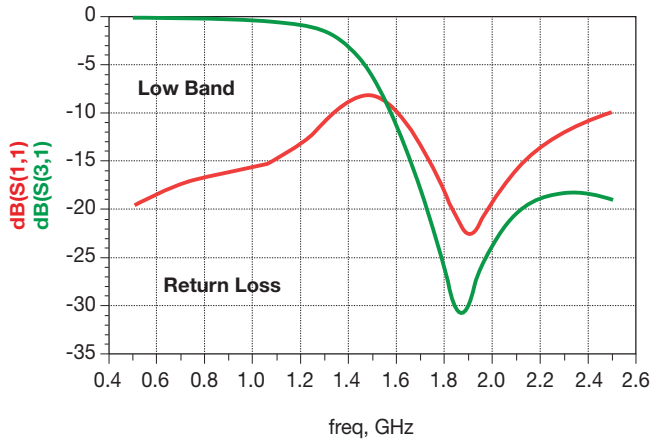

Note: Measurements were taken using an Anritsu 4 port VNA; Diplexer was mounted on a custom evaluation board. To reduce systematic errors from the VNA, the coaxial measurement cables, and evaluation board, a Short-Open-Load-Thru (SOLT) calibration was performed, using a custom fabricated calibration substrate. This is the most common coaxial calibration methods.

Multilayer Organic (MLO®) Diplexers

0805 WCDMA

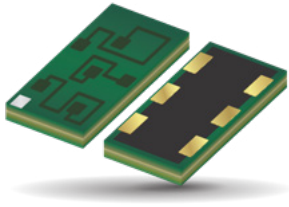

MLO® TECHNOLOGY

The 0805 diplexer is a best in class low profile multilayer organic passive device that is based on KYOCERA AVX patented multilayer organic high density interconnect technology. The MLO® diplexer uses high dielectric constant and low loss materials to realize high Q passive printed passive elements such as inductors and capacitors in a multilayer stack up. The MLO® diplexers can support multiple wireless standards such as WCDMA, CDMA, WLAN, and GSM and are less than 0.6mm in thickness. These components are ideally suited for band switching for dual band systems. All diplexers are expansion matched to FR4 thereby resulting in improved reliability over standard Si and ceramic devices.

APPLICATIONS

Multiband applications including WCDMA, WLAN, WiMax, GPS, and cellular bands

LAND GRID ARRAY ADVANTAGES

- Low Insertion Loss
- Excellent Solderability
- Low Parasitics
- Low Profile

HOW TO ORDER

DP	05	A	1940	7	TR
Type	Size	Design	Frequency (MHz)	Finish	Packaging
				7 = Au T = NiSn	Tape & Reel TR = 3 Kpcs TR/500 = 500 pcs



QUALITY INSPECTION

Finished parts are 100% tested for electrical parameters and visual characteristics.

OPERATING TEMPERATURE

-40°C to +85°C

TERMINATION

Finishes available in Ni/Sn, Immersion Sn, Immersion Au and OSP coatings which are compatible with automatic soldering technologies which include reflow, wave soldering, vapor phase and manual.

ORIENTATION IN TAPE

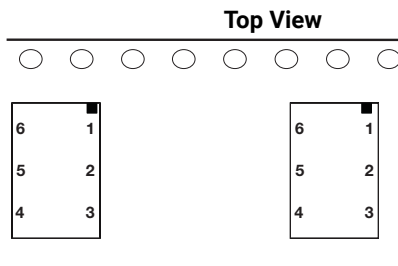

POWER CAPACITY

4.5W Maximum

COMPONENT DIMENSIONS AND FUNCTIONS

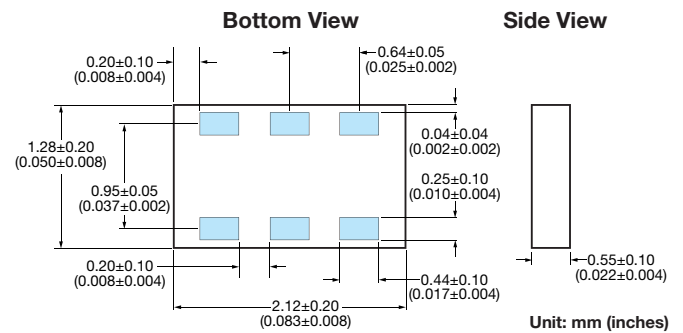

Terminal No.	Terminal Name
1	High Frequency Port
2	GND
3	Low Frequency Port
4	GND
5	Common Port
6	GND

PART NUMBER: DP05A19407TR

Specification @ 25°C	
Size [mm(inches)]	2.12 x 1.28 (0.083 x 0.050)
Height [mm(inches)]	0.55 (0.021)
Volume (mm³)	1.5
Frequency Range (F1) (MHz)	892±68
Frequency Range (F2) (MHz)	1940±230
Insertion Loss (F1, at Fc) (dB)	-0.4
Insertion Loss (F2, at Fc) (dB)	-0.65
Attenuation (F1) at (F2) (dB)	-23
Attenuation (F2) at (F1) (dB)	-20
VSWR (Input @ F1)	1.3
VSWR (Input @ F2)	1.4
VSWR (Lowband @ F1)	1.4
VSWR (Highband @ F2)	1.2

Multilayer Organic (MLO®) Diplexers

0805 WCDMA

S PARAMETER MEASUREMENTS

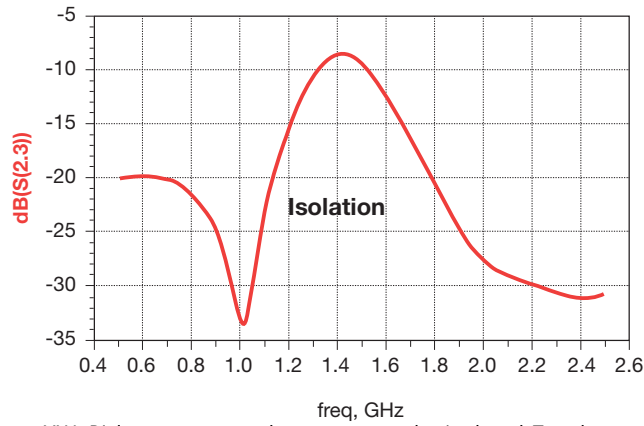
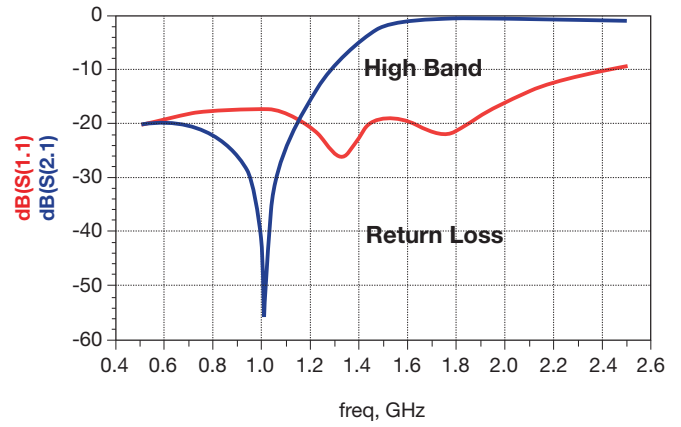
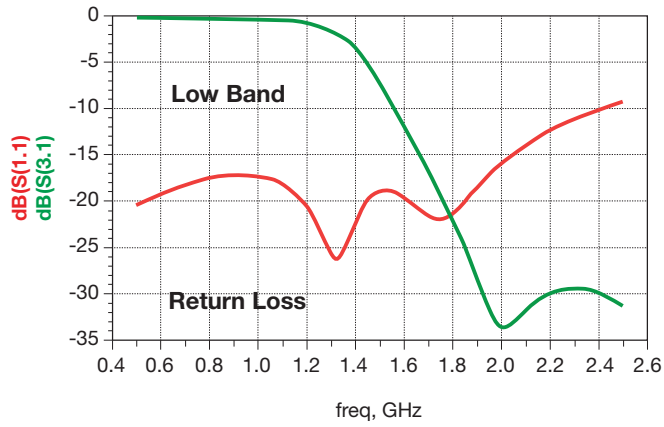

Note: Measurements were taken using an Anritsu 4 port VNA; Diplexer was mounted on a custom evaluation board. To reduce systematic errors from the VNA, the coaxial measurement cables, and evaluation board, a Short-Open-Load-Thru (SOLT) calibration was performed, using a custom fabricated calibration substrate. This is the most common coaxial calibration methods.

Multilayer Organic (MLO®) Diplexers

0805 WLAN

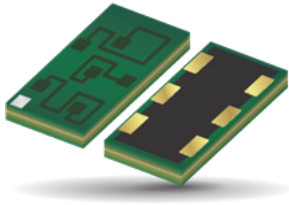

MLO® TECHNOLOGY

The 0805 diplexer is a best in class low profile multilayer organic passive device that is based on KYOCERA AVX patented multilayer organic high density interconnect technology. The MLO® diplexer uses high dielectric constant and low loss materials to realize high Q passive printed elements such as inductors and capacitors in a multilayer stack up. The MLO® diplexers can support multiple wireless standards such as WCDMA, CDMA, WLAN and GSM. These components which are less than 0.6mm in thickness are ideally suited for band switching for dual band systems. All diplexers are expansion matched to FR4 thereby resulting in improved reliability over standard Si and ceramic devices.

APPLICATIONS

Multiband applications including WiFi, WiMax, GPS, and cellular bands

LAND GRID ARRAY ADVANTAGES

- Low Insertion Loss
- Excellent Solderability
- Low Parasitics
- Low Profile

HOW TO ORDER

DP	05	A	5250	7	TR
Type	Size	Design	Frequency (MHz)	Finish	Packaging
				7 = Au T = NiSn	Tape & Reel TR = 3 Kpcs TR/500 = 500 pcs



QUALITY INSPECTION

Finished parts are 100% tested for electrical parameters and visual characteristics.

OPERATING TEMPERATURE

-40°C to +85°C

TERMINATION

Finishes available in Ni/Sn, Immersion Sn, Immersion Au and OSP coatings which are compatible with automatic soldering technologies which include reflow, wave soldering, vapor phase and manual.

ORIENTATION IN TAPE

Top View

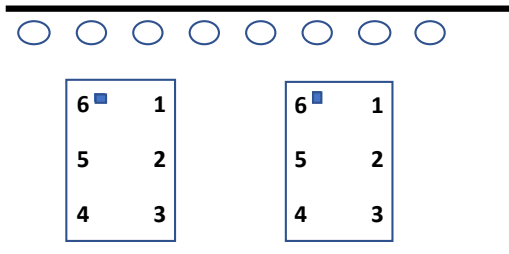

Note part will be packaged with dot near hole in tape. Location of dot may vary.

POWER CAPACITY

4.5W Maximum

COMPONENT DIMENSIONS AND FUNCTIONS

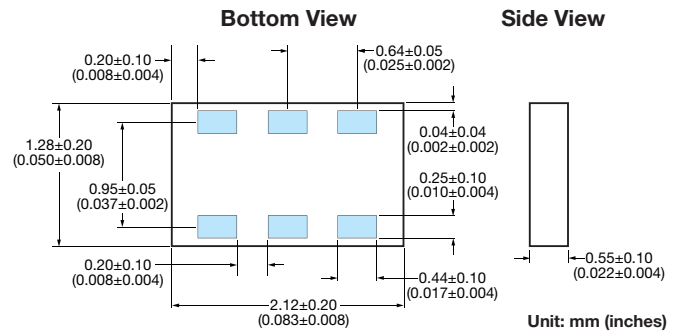

Terminal No.	Terminal Name
1	High Frequency Port
2	GND
3	Low Frequency Port
4	GND
5	Common Port
6	GND

PART NUMBER: DP05A52507TR

Specification @ 25°C	
Size [mm(inches)]	2.12 x 1.28 (0.083 x 0.050)
Height [mm(inches)]	0.55 (0.021)
Volume (mm³)	1.5
Frequency Range (F1) (MHz)	2450±50
Frequency Range (F2) (MHz)	5250±100
Insertion Loss (F1) (dB)	-0.5
Insertion Loss (F2) (dB)	-0.5
Attenuation (F1) at (F2) (dB)	-20
Attenuation (F2) at (F1) (dB)	-20
Return Loss (Lowband @ F1) (dB)	-12
Return Loss (Highband @ F2) (dB)	-12
Isolation (Lowband @ F1) (dB)	-25
Isolation (Highband @ F2) (dB)	-21

Multilayer Organic (MLO®) Diplexers

0805 WLAN

S PARAMETER MEASUREMENTS

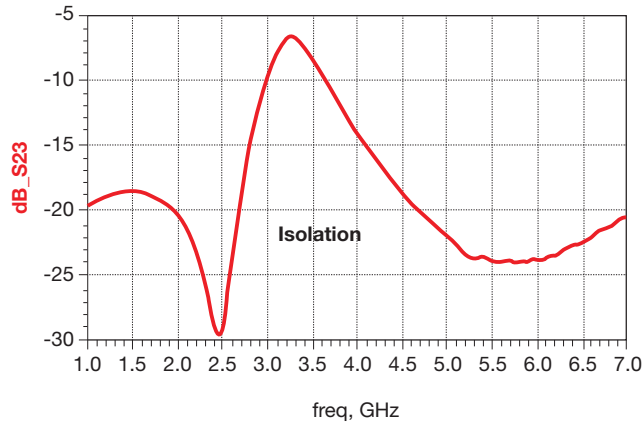
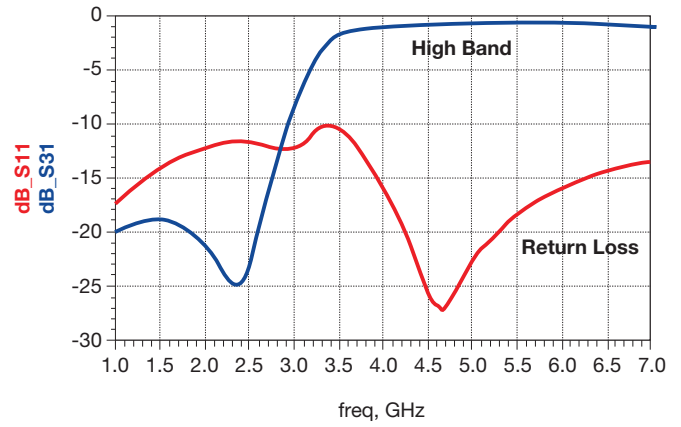

Multilayer Organic (MLO®) Diplexers

0805 WLAN/BT

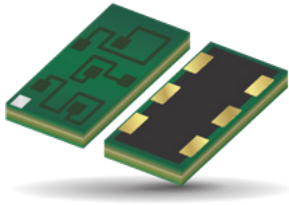

MLO® TECHNOLOGY

The 0805 MLO® diplexer is best in class low profile multilayer organic passive device that is based on KYOCERA AVX patented multilayer organic high density interconnect technology. The MLO® diplexer uses high dielectric constant and low loss materials to realize high Q passive printed elements such as inductors and capacitors in a multilayer stack up. The MLO® diplexers can support multiple wireless standards such as WCDMA, CDMA, WLAN and GSM. These components which are less than 0.5mm in thickness are ideally suited for band switching for dual band systems. All MLO® diplexers are expansion matched to FR4 thereby resulting in improved reliability over standard Si and ceramic devices.

APPLICATIONS

Multiband applications including WiFi, BT, WiMax, GPS, and cellular bands

LAND GRID ARRAY ADVANTAGES

- Low Insertion Loss
- Excellent Solderability
- Low Parasitics
- Matched CTE to PCB

HOW TO ORDER

DP	05	B	5425	7	TR
Type	Size	Design	Frequency (MHz)	Finish 7 = Au T = NiSn	Packaging Tape & Reel TR = 3 Kpcs TR/500 = 500 pcs



QUALITY INSPECTION

Finished parts are 100% tested for electrical parameters and visual characteristics.

OPERATING TEMPERATURE

-40°C to +85°C

TERMINATION

Finishes available in Ni/Sn, Immersion Sn, Immersion Au and OSP coatings which are compatible with automatic soldering technologies which include reflow, wave soldering, vapor phase and manual.

ORIENTATION IN TAPE

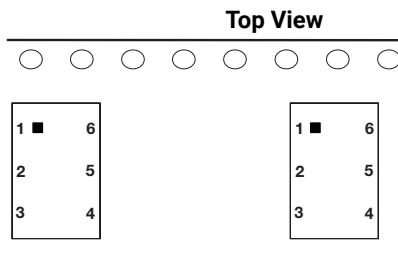

POWER CAPACITY

4.5W Maximum

COMPONENT DIMENSIONS AND FUNCTIONS

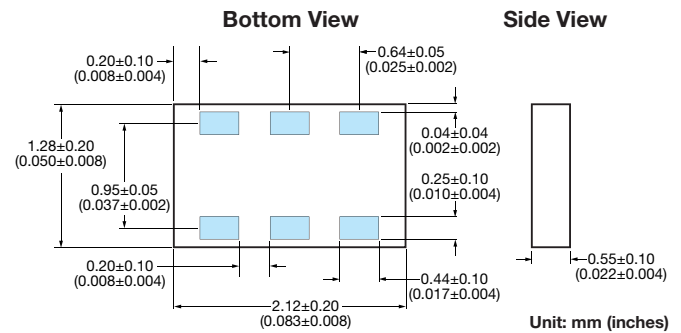

Terminal No.	Terminal Name
1	Low Frequency Port
2	GND
3	High Frequency Port
4	GND
5	Common Port
6	GND

PART NUMBER: DP05B54257TR

Specification @ 25°C	
Size [mm(inches)]	2.12 x 1.28 (0.083 x 0.050)
Height [mm(inches)]	0.55 (0.021)
Volume (mm³)	1.5
Pass Band Range (F1) (MHz)	2450 +/-50MHz
Pass Band Range (F2) (MHz)	5425 +/-525MHz
Insertion Loss (F1) (dB)	-0.5
Insertion Loss (F2) (dB)	-1.0
Attenuation (F1) 4800MHz - 6000MHz (dB)	-36
Attenuation 3 x (F1) (dB)	-31
Attenuation (F2) 1800MHz - 2500MHz (dB)	-26
Attenuation 2 x (F2) (dB)	-13
Attenuation 3 x (F2) (dB)	-15
VSWR (Input @ F1)	1.2
VSWR (Input @ F2)	1.7
VSWR (Lowband @ F1)	1.2
VSWR (Highband @ F2)	1.7

Multilayer Organic (MLO[®]) Diplexers

0805 WLAN/BT

S PARAMETER MEASUREMENTS

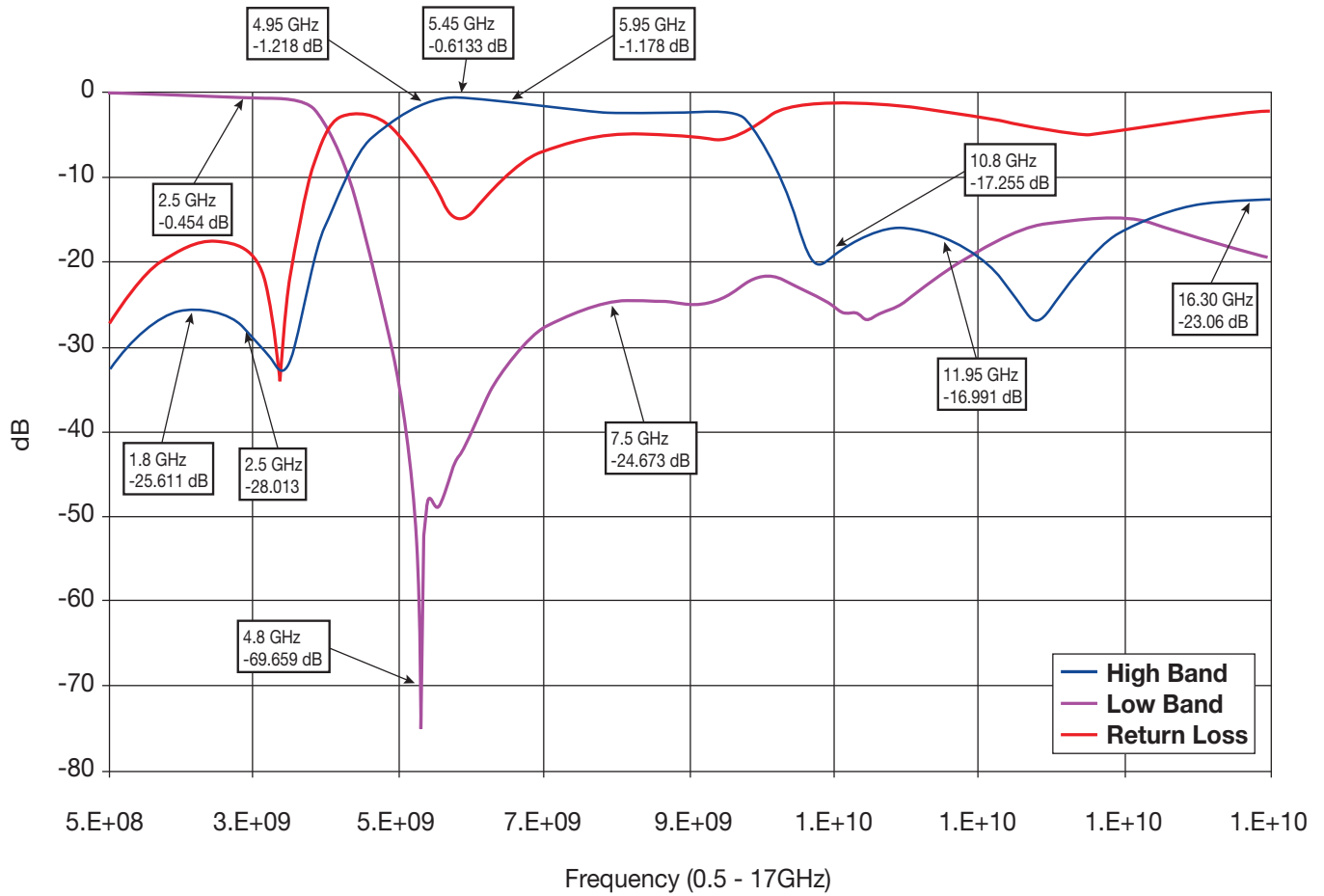

Multilayer Organic (MLO®) Diplexers

Automated SMT Assembly/SMT Reflow Profile

AUTOMATED SMT ASSEMBLY

The following section describes the guidelines for automated SMT assembly of MLO® RF devices which are typically Land Grid Array (LGA) packages or side termination SMT packages.

Control of solder and solder paste volume is critical for surface mount assembly of MLO® RF devices onto the PCB. Stencil thickness and aperture

openings should be adjusted according to the optimal solder volume. The following are general recommendations for SMT mounting of MLO® devices onto the PCB.

SMT REFLOW PROFILE

Common IR or convection reflow SMT processes shall be used for the assembly. Standard SMT reflow profiles, for eutectic and Pb free solders, can be used to surface mount the MLO® devices onto the PCB. In all cases, a temperature gradient of 3°C/sec, or less, should be maintained to prevent warpage of the package and to ensure that all joints reflow properly. Additional soak time and slower preheating time may be required

to improve the out-gassing of solder paste. In addition, the reflow profile depends on the PCB density and the type of solder paste used. Standard no-clean solder paste is generally recommended. If another type of flux is used, complete removal of flux residual may be necessary. Example of a typical lead free reflow profile is shown below.

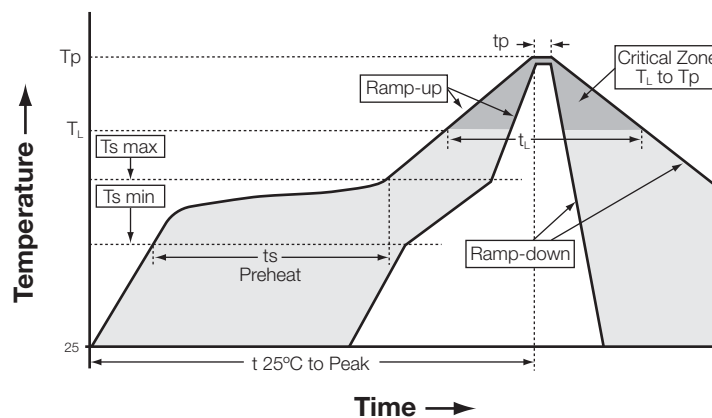
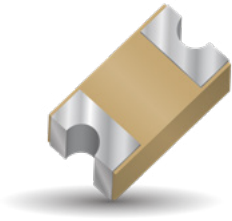

Figure A. Typical Lead Free Profile and Parameters

Profile Parameter	Pb free, Convection, IR/Convection
Ramp-up rate (T _s max to T _p)	3°C/second max.
Preheat temperature (T _s min to T _s max)	150°C to 200°C
Preheat time (t _s)	60 – 180 seconds
Time above T _L , 217°C (t _L)	60 – 120 seconds
Peak temperature (T _p)	260°C
Time within 5°C of peak temperature (t _p)	10 – 20 seconds
Ramp-down rate	4°C/second max.
Time 25°C to peak temperature	6 minutes max.

Multilayer Organic (MLO®) Inductors

Tight Tolerance



The Multilayer Organic Tight Tolerance Inductor is a low profile organic based inductor that can support mobile communications, satellite applications, GPS, matching networks, and collision avoidance. The MLO® Tight Tolerance Inductor series of components are based on KYOCERA AVX patented multilayer organic technology (US patent 6,987,307). MLO® Tight Tolerance Inductors incorporate very low loss organic materials which allow for high Q and high stability over frequency. MLO® Tight Tolerance Inductors are surface mountable and are expansion matched to FR4 printed wiring boards. MLO® Tight Tolerance Inductors utilize fine line high density interconnect technology thereby allowing for tight tolerance control and high repeatability. Reliability testing is performed to JEDEC and mil standards. Finishes are available in RoHS compliant Sn.

APPLICATIONS

- Mobile communications
- Satellite Applications
- GPS
- Collision Avoidance
- Wireless LAN's

FEATURES

- Tight Tolerance
- High Frequency
- High Withstanding Voltage
- Low DC Resistance
- Surface Mountable
- 0402 Case Size
- RoHS Compliant Finishes
- Available in Tape and Reel

SURFACE MOUNT ADVANTAGES

- Inherent Low Profile
- Excellent Solderability
- Low Parasitics
- Better Heat Dissipation
- Expansion Matched to PCB

HOW TO ORDER

HL
Tight Tolerance

02
Size
02 = 0402

XXX
Inductance
Expressed in nH
(2 significant digits + number of zeros)
for values <10nH,
letter R denotes decimal point.
Example:
22nH = 220
4.7nH = 4R7

X
Tolerance
A = ±0.05nH
B = ±0.1nH
G = ±2%

T
Termination
Sn100

TR
Packaging
5000pcs
T&R



DIMENSIONS

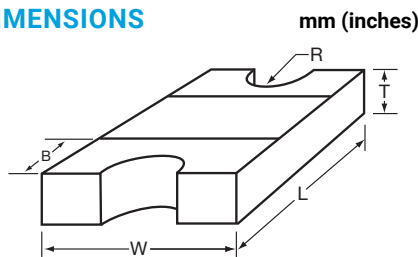

mm (inches)				
L	W	T	R	B
1.00±0.10 (0.040±0.004)	0.58±0.075 (0.023±0.003)	0.35±0.10 (0.014±0.004)	0.125±0.050 (0.005±0.002)	0.23±0.0508 (0.0092±0.002)

QUALITY INSPECTION

Finished parts are 100% tested for electrical parameters and visual characteristics.

TERMINATION

RoHS compliant Sn finish.

OPERATING TEMPERATURE

-55°C to +125°C

Multilayer Organic (MLO®) Inductors

Tight Tolerance

RECOMMENDED FOOTPRINT

mm (inches)

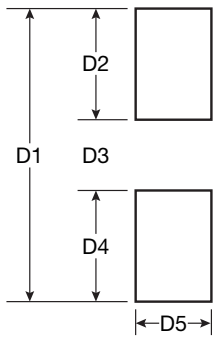

Case Size	D1	D2	D3	D4	D5
0201	0.85 (0.033)	0.30 (0.012)	0.25 (0.010)	0.30 (0.012)	0.35 (0.014)
0402	1.70 (0.067)	0.60 (0.024)	0.50 (0.020)	0.60 (0.024)	0.50 (0.020)
0603	2.30 (0.091)	0.80 (0.031)	0.70 (0.028)	0.80 (0.031)	0.75 (0.030)
0805	3.00 (0.118)	1.00 (0.039)	1.00 (0.039)	1.00 (0.039)	1.25 (0.049)
1206	4.00 (0.157)	1.00 (0.039)	2.00 (0.079)	1.00 (0.039)	1.60 (0.063)
1210	4.00 (0.157)	1.00 (0.039)	2.00 (0.079)	1.00 (0.039)	2.50 (0.098)
1808	5.60 (0.220)	1.00 (0.039)	3.60 (0.142)	1.00 (0.039)	2.00 (0.079)
1812	5.60 (0.220)	1.00 (0.039)	3.60 (0.142)	1.00 (0.039)	3.00 (0.118)
1825	5.60 (0.220)	1.00 (0.039)	3.60 (0.142)	1.00 (0.039)	6.35 (0.250)
2220	6.60 (0.260)	1.00 (0.039)	4.60 (0.181)	01.00 (0.039)	5.00 (0.197)
2225	6.60 (0.260)	1.00 (0.039)	4.60 (0.181)	1.00 (0.039)	6.35 (0.250)

Component Pad Design

Component pads should be designed to achieve good solder fillets and minimize component movement during reflow soldering. pad designs are given below for the most common sizes of multilayer ceramic capacitors for both wave and reflow soldering. The basis of these designs is:

- Pad width equal to component width. It is permissible to decrease this to as low as 85% of component width but it is not advisable to go below this.
- Pad overlap 0.5mm beneath component.
- Pad extension 0.5mm beyond components for reflow and 1.0mm to wave soldering.

0402 ELECTRICAL SPECIFICATIONS

L (nH) 450MHz	Available Inductance Tolerance A = ±0.05nH, B = ±0.1nH, G = ±2%	Q 450MHz	Idc max (mA)	Rdc max (mΩ)	SRF min (GHz)
0.8	±0.05nH, ±0.1nH	15	450	100	7
0.9	±0.05nH, ±0.1nH	15	450	100	7
1	±0.05nH, ±0.1nH	15	420	100	7
1.1	±0.05nH, ±0.1nH	15	410	100	7
1.2	±0.05nH, ±0.1nH	15	410	110	7
1.3	±0.05nH, ±0.1nH	15	295	13	7
1.5	±0.05nH, ±0.1nH	15	295	150	7
1.6	±0.05nH, ±0.1nH	15	230	150	7
1.8	±0.05nH, ±0.1nH	15	295	160	7
2	±0.05nH, ±0.1nH	15	230	18	7
2.2	±0.05nH, ±0.1nH	15	230	200	7
2.4	±0.05nH, ±0.1nH	15	230	200	7
2.7	±0.05nH, ±0.1nH	15	230	250	7
3	±0.05nH, ±0.1nH	15	200	300	7
3.3	±0.05nH, ±0.1nH	15	200	340	7
3.6	±0.05nH, ±0.1nH	15	180	350	7
3.9	±0.05nH, ±0.1nH	15	180	400	7
4.7	±0.1nH	15	170	480	7
5.6	±0.1nH	15	150	500	7
6.8	±0.1nH	15	140	600	7
8.2	±0.1nH	15	115	800	6
10	±2%	15	105	1000	5
12	±2%	15	95	1100	4
15	±2%	15	95	1200	4
18	±2%	15	85	1500	3
22	±2%	15	75	1900	3
27	±2%	15	75	2100	3
30	±2%	15	65	2200	2
32	±2%	15	65	2200	2

Specifications based on performance of component assembled properly on printed circuit board with 50Ω nominal impedance.

Multilayer Organic (MLO®) Inductors

High Current

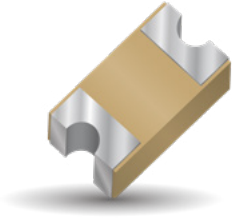

The Multilayer Organic High Current Inductor is a low profile organic based inductor that can support mobile communications, satellite applications, GPS, matching networks, and collision avoidance. Based on KYOCERA AVX patented multilayer organic technology (US patent 6,987,307), the 0402 size Multilayer Organic High Current Inductor allows for much higher current handling over similar multilayer ceramic chip inductors, a 50% average increase in current handling over comparable thin film products with similar Q, and current handling approaching that of wire wound ceramic chip inductors. MLO® High Current Inductors incorporate very low loss organic materials which allow for high Q and high stability over frequency. They are surface mountable and are expansion matched to FR4 printed wiring boards. MLO® High Current Inductors utilize fine line high density interconnect technology thereby allowing for tight tolerance control and high repeatability. Reliability testing is performed to JEDEC and mil standards. Finishes are available in RoHS compliant Sn.

APPLICATIONS

- Mobile communications
- Satellite Applications
- GPS
- Collision Avoidance
- Wireless LAN's

FEATURES

- High Q
- High SRF
- High Frequency
- High Current Handling
- Low DC Resistance
- Surface Mountable
- 0402 Case Size
- RoHS Compliant Finishes
- Available in Tape and Reel

SURFACE MOUNT ADVANTAGES

- Inherent Low Profile
- Excellent Solderability
- Low Parasitics
- Better Heat Dissipation
- Expansion Matched to PCB

HOW TO ORDER

HLC

Type
HLC = High Current

02

Size
02 = 0402

XXX

Inductance
Expressed in nH
(2 significant digits + number of zeros)
for values <10nH,
letter R denotes decimal point.
Example:
22nH = 220
4.7nH = 4R7

X

Tolerance
B = ±0.1nH
C = ±0.2nH
D = ±0.5nH
G = ±2%
H = ±3%
J = ±5%

T

Termination
Sn100

TR

Packaging
5000pcs T&R



DIMENSIONS

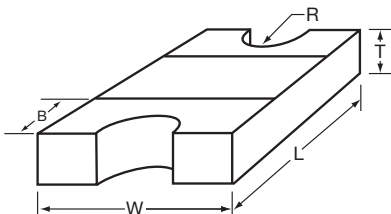

mm (inches)

L	W	T	R	B
1.00±0.10 (0.040±0.004)	0.58±0.075 (0.023±0.003)	0.35±0.10 (0.014±0.004)	0.125±0.050 (0.005±0.002)	0.23±0.0508 (0.0092±0.002)

QUALITY INSPECTION

Finished parts are 100% tested for electrical parameters and visual characteristics.

TERMINATION

RoHS compliant Sn finish.

OPERATING TEMPERATURE

-55°C to +125°C

Multilayer Organic (MLO®) Inductors

High Current

0402 ELECTRICAL SPECIFICATIONS

450 MHz Test Frequency			900 MHz Test Frequency		1900 MHz Test Frequency		2400 MHz Test Frequency		SRF Min (GHz)	Rdc Max (mΩ)	Idc Max (mA)
L (nH) 450 MHz	Available Inductance Tolerance B = ±0.1nH, C = ±0.2nH D = ±0.5nH, G = ±2% H = ±3%, J = ±5%	Q 450 MHz	L (nH) 900 MHz	Q 900 MHz	L (nH) 1900 MHz	Q 1900 MHz	L (nH) 2400 MHz	Q 2400 MHz			
0.8	±0.1nH, ±0.2nH, ±0.5nH	30	0.8	42	0.8	55	0.8	61	>20	100	875
0.9	±0.1nH, ±0.2nH, ±0.5nH	26	0.9	36	0.9	47	0.9	52	>20	100	835
1	±0.1nH, ±0.2nH, ±0.5nH	25	1.0	34	1.0	45	1.0	50	>20	100	800
1.1	±0.1nH, ±0.2nH, ±0.5nH	24	1.1	33	1.1	43	1.1	48	20	100	782
1.2	±0.1nH, ±0.2nH, ±0.5nH	24	1.2	33	1.2	44	1.2	48	20	110	751
1.3	±0.1nH, ±0.2nH, ±0.5nH	25	1.3	34	1.3	44	1.3	49	19	130	725
1.5	±0.1nH, ±0.2nH, ±0.5nH	25	1.5	35	1.5	45	1.5	50	19	150	679
1.6	±0.1nH, ±0.2nH, ±0.5nH	25	1.6	35	1.6	45	1.6	49	18	150	660
1.8	±0.1nH, ±0.2nH, ±0.5nH	25	1.8	35	1.8	45	1.8	49	18	160	626
2	±0.1nH, ±0.2nH, ±0.5nH	26	2.0	35	2.0	45	2.1	49	17	180	596
2.2	±0.1nH, ±0.2nH, ±0.5nH	27	2.2	36	2.2	46	2.2	50	16	200	571
2.4	±0.1nH, ±0.2nH, ±0.5nH	27	2.4	37	2.4	47	2.4	50	15	200	549
2.7	±0.1nH, ±0.2nH, ±0.5nH	27	2.7	36	2.7	46	2.7	48	14	250	521
3	±0.1nH, ±0.2nH, ±0.5nH	27	3.0	36	3.0	44	3.1	46	12	300	497
3.3	±0.1nH, ±0.2nH, ±0.5nH	27	3.3	36	3.3	44	3.4	46	11	340	476
3.6	±0.1nH, ±0.2nH, ±0.5nH	27	3.6	37	3.7	45	3.8	46	10	350	457
3.9	±0.1nH, ±0.2nH, ±0.5nH	28	3.9	38	4.0	46	4.1	47	10	400	441
4.7	±0.1nH, ±0.2nH, ±0.5nH	29	4.7	39	4.9	45	5.1	44	9	480	405
5.6	±0.1nH, ±0.2nH, ±0.5nH	30	5.7	40	6.0	44	6.3	42	8	500	375
6.8	±2%, ±3%, ±5%	30	6.9	39	7.5	41	8.0	37	7	600	343
8.2	±2%, ±3%, ±5%	29	8.4	37	9.4	37	10.4	31	6	800	315
10	±2%, ±3%, ±5%	30	10.3	38	12.0	35	13.9	27	5	1000	290
12	±2%, ±3%, ±5%	32	12.5	40	15.7	31	19.8	19	4	1100	265
15	±2%, ±3%, ±5%	32	15.9	38	22.3	24	33.0	9	4	1200	240
18	±2%, ±3%, ±5%	28	19.4	32	31.1	15	60.0	0.3	3	1500	210
22	±2%, ±3%, ±5%	30	24.0	34	44.7	11	n/a	n/a	3	1900	202
27	±2%, ±3%, ±5%	29	30.5	30	n/a	n/a	n/a	n/a	3	2100	184
30	±2%, ±3%, ±5%	28	34.0	27	n/a	n/a	n/a	n/a	2	2200	180
32	±2%, ±3%, ±5%	28	37.7	27	n/a	n/a	n/a	n/a	2	2200	175

Specifications based on performance of component assembled properly on printed circuit board with 50Ω nominal impedance.

Idc max: Maximum 15°C rise in component temperature over ambient.

Multilayer Organic (MLO®) Inductors

Hi-Q

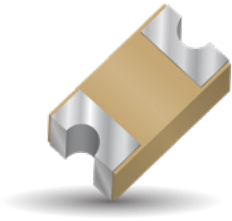

The Multilayer Organic Hi-Q Inductor is a low profile organic based inductor that can support mobile communications, satellite applications, GPS, matching networks, and collision avoidance. The MLO® Hi-Q Inductor series of components are based on KYOCERA AVX patented multilayer organic technology (US patent 6,987,307 and 7,439,840). MLO® Hi-Q Inductors incorporate very low loss organic materials and low profile copper which allow for high Q and high stability over frequency. MLO® Hi-Q Inductors are surface mountable and are expansion matched to FR4 printed wiring boards. MLO® Hi-Q Inductors utilize fine line high density interconnect technology thereby allowing for tight tolerance control and high repeatability. Reliability testing is performed to JEDEC and mil standards. Finishes are available in RoHS compliant Sn.

APPLICATIONS

- Mobile communications
- Satellite Applications
- GPS
- Collision Avoidance
- Wireless LAN's

FEATURES

- High Q
- High SRF
- High Frequency
- Low DC Resistance
- Surface Mountable
- 0402 Case Size
- RoHS Compliant Finishes
- Available in Tape and Reel

SURFACE MOUNT ADVANTAGES

- Inherent Low Profile
- Excellent Solderability
- Low Parasitics
- Better Heat Dissipation
- Expansion Matched to PCB

HOW TO ORDER

HLQ
Type
HLQ = High Q

02
Size
02 = 0402

XXX
Inductance
Expressed in nH
(2 significant digits + number of zeros)
for values <10nH,
letter R denotes decimal point.
Example:
22nH = 220
4.7nH = 4R7

X
Tolerance
B = ±0.1nH
C = ±0.2nH
H = ±3%

T
Termination
Sn100

TR
Packaging
5000pcs T&R



DIMENSIONS

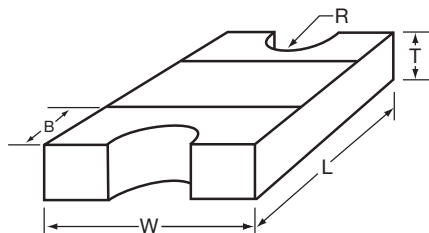

mm (inches)

L	W	T	R	B
1.00±0.10 (0.040±0.004)	0.58±0.075 (0.023±0.003)	0.35±0.10 (0.014±0.004)	0.125±0.050 (0.005±0.002)	0.23±0.0508 (0.0092±0.002)

QUALITY INSPECTION

Finished parts are 100% tested for electrical parameters and visual characteristics.

TERMINATION

RoHS compliant Sn finish.

OPERATING TEMPERATURE

-55°C to +125°C

Multilayer Organic (MLO®) Inductors

Hi-Q

0402 ELECTRICAL SPECIFICATIONS

L (nH) 450MHz	Available Inductance Tolerance B = ±0.1nH, C = ±0.2nH H = ±3%	Q min 450MHz	SRF min (GHz)	Rdc max (mΩ)	Idc max (mA)
0.8	±0.1nH, ±0.2nH	17	7	100	350
0.9	±0.1nH, ±0.2nH	17	7	100	350
1	±0.1nH, ±0.2nH	17	7	100	330
1.1	±0.1nH, ±0.2nH	17	7	100	330
1.2	±0.1nH, ±0.2nH	17	7	110	330
1.3	±0.1nH, ±0.2nH	17	7	130	330
1.5	±0.1nH, ±0.2nH	17	7	150	330
1.6	±0.1nH, ±0.2nH	17	7	150	300
1.8	±0.1nH, ±0.2nH	17	7	160	300
2	±0.1nH, ±0.2nH	17	7	180	245
2.2	±0.1nH, ±0.2nH	17	7	200	245
2.4	±0.1nH, ±0.2nH	17	7	200	245
2.7	±0.1nH, ±0.2nH	17	7	250	245
3	±0.1nH, ±0.2nH	17	7	300	225
3.3	±0.1nH, ±0.2nH	17	7	340	225
3.6	±0.1nH, ±0.2nH	17	7	350	200
3.9	±0.1nH, ±0.2nH	17	7	400	200
4.7	±0.1nH, ±0.2nH	17	7	480	195
5.6	±0.1nH, ±0.2nH	17	7	500	170
6.8	±3%	17	7	600	160
8.2	±3%	17	6	800	130
10	±3%	17	5	1000	120
12	±3%	17	4	1100	110
15	±3%	17	4	1200	110
18	±3%	17	3	1500	110
22	±3%	17	3	1900	95
27	±3%	17	3	2100	95
30	±3%	17	2	2200	85
32	±3%	17	2	2200	85

Specifications based on performance of component assembled properly on printed circuit board with 50Ω nominal impedance.
Idc max: Maximum 15°C rise in component temperature over ambient.

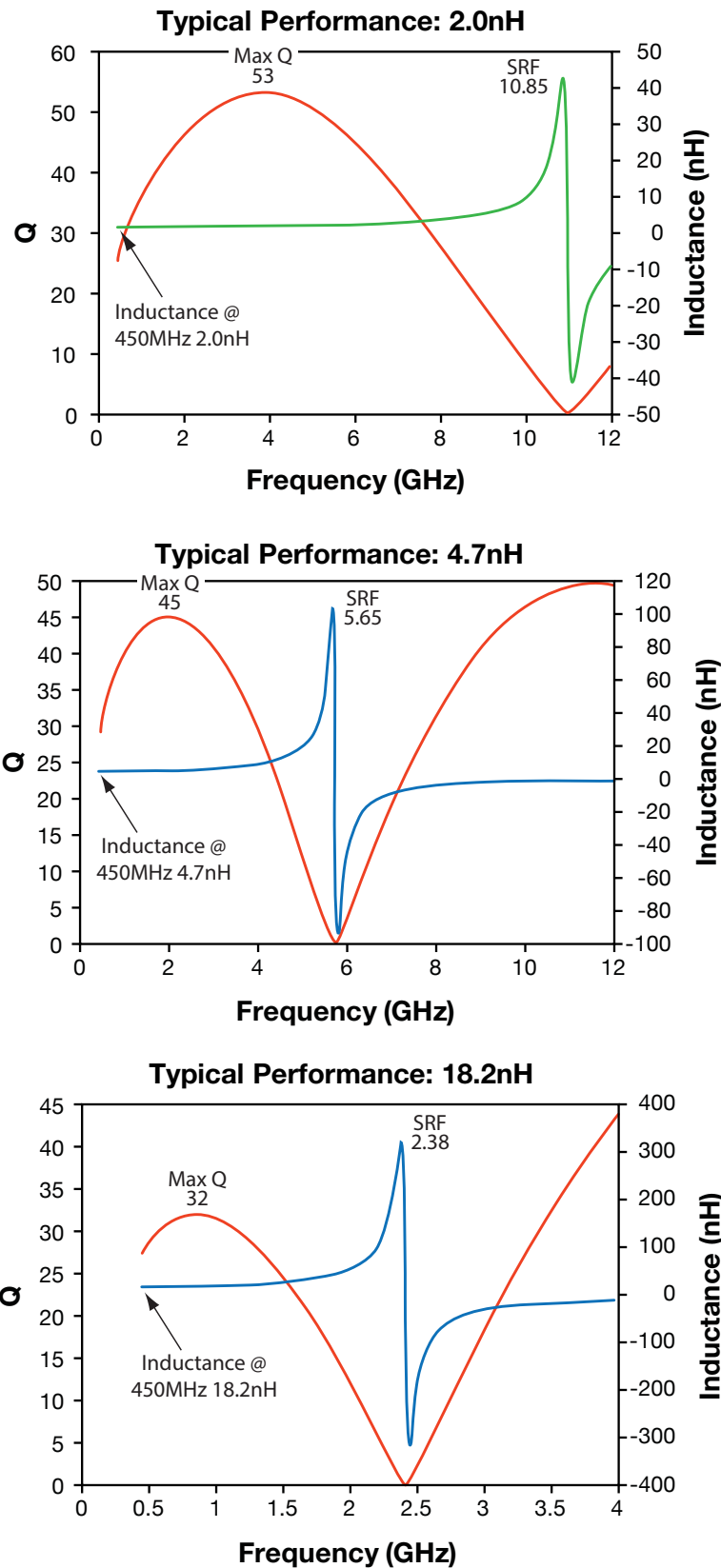

Multilayer Organic (MLO®) Inductors

Automated SMT Assembly/SMT Reflow Profile

AUTOMATED SMT ASSEMBLY

The following section describes the guidelines for automated SMT assembly of MLO® RF devices which are typically Land Grid Array (LGA) packages or side termination SMT packages.

Control of solder and solder paste volume is critical for surface mount assembly of MLO® RF devices onto the PCB. Stencil thickness and aperture

openings should be adjusted according to the optimal solder volume. The following are general recommendations for SMT mounting of MLO® devices onto the PCB.

SMT REFLOW PROFILE

Common IR or convection reflow SMT processes shall be used for the assembly. Standard SMT reflow profiles, for eutectic and Pb free solders, can be used to surface mount the MLO® devices onto the PCB. In all cases, a temperature gradient of 3°C/sec, or less, should be maintained to prevent warpage of the package and to ensure that all joints reflow properly. Additional soak time and slower preheating time may be required to improve

the out-gassing of solder paste. In addition, the reflow profile depends on the PCB density and the type of solder paste used. Standard no-clean solder paste is generally recommended. If another type of flux is used, complete removal of flux residual may be necessary. Example of a typical lead free reflow profile is shown below.

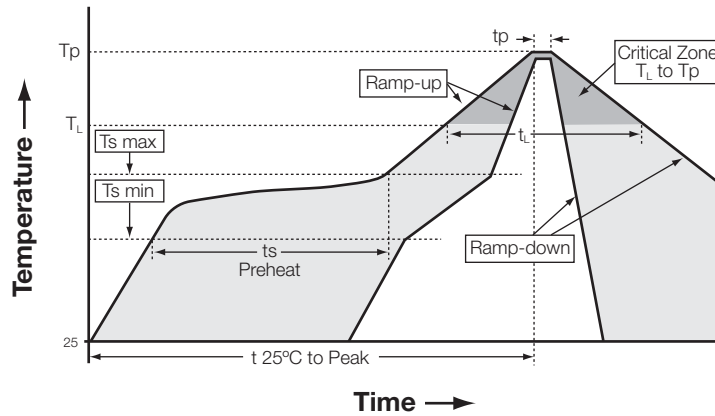
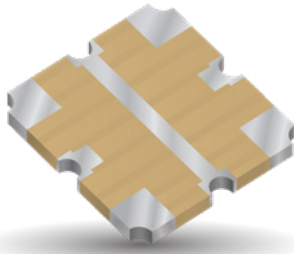

Figure A. Typical Lead Free Profile and Parameters

Profile Parameter	Pb free, Convection, IR/Convection
Ramp-up rate (T _{smax} to T _p)	3°C/second max.
Preheat temperature (T _{s min} to T _{s max})	150°C to 200°C
Preheat time (t _s)	60 – 180 seconds
Time above T _L , 217°C (t _L)	60 – 120 seconds
Peak temperature (T _p)	260°C
Time within 5°C of peak temperature (t _p)	10 – 20 seconds
Ramp-down rate	4°C/second max.
Time 25°C to peak temperature	6 minutes max.

Multilayer Organic (MLO®) SMT Crossovers

RF-DC



GENERAL DESCRIPTION

The MLO® SMT RF-DC Crossover is a very low profile crossover that intersects an RF and DC circuit trace in an SMT package. The RF-DC Crossover is a low cost solution for applications where a critical RF circuit trace intersects a DC circuit precluding the need for an expensive multilayer printed circuit board. The SMT package can support frequencies up to 6 GHz. MLO® crossovers have been subjected to JEDEC reliability standards and 100% electrically tested. The RF-DC crossovers are available in NiSn.

FEATURES

- DC – 6.0 GHz
- RF – DC Crossover
- Low Loss
- DC Isolation
- Surface Mountable
- Tape and Reel
- 100% Tested

APPLICATIONS

- Military and Commercial Radar
- Medical Imaging Electronics
- Communications Transmitter
- Optical Drivers

LAND GRID ARRAY ADVANTAGES

- Inherent Low Profile
- Excellent Solderability
- Low Parasitics
- Better Heat Dissipation

TOP VIEW

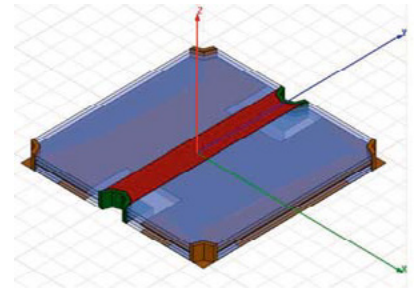

HOW TO ORDER

X2A	2020	RFDC	T
Series	Size	Type	Packaging
			T = 1000pcs T&R T/250 = 250pcs T&R B = Bulk



Frequency (GHz)	Port Impedance (ohms)	Ins. Loss (dB max)	Return Loss (dB min)	Power (Watts)	θJC (°C /Watts)	Operating Temperature (°C)
DC -2.5	50	0.05	20	30	140	-55 to +85
2.5 - 4.0	50	0.10	20	19	140	-55 to +85
4.0 - 6.0	50	0.15	15	9	140	-55 to +85

* Specification based on performance of component assembled properly on printed circuit board with 50Ω nominal impedance.

QUALITY INSPECTION

Finished parts are 100% tested for electrical parameters and visual characteristics.

TERMINATION

NiSn compatible with automatic soldering technologies: Pb free reflow, wave soldering, vapor phase and manual.

- 55°C to +85°C

OPERATING TEMPERATURE

Multilayer Organic (MLO®) SMT Crossovers

RF-DC

MECHANICAL OUTLINE

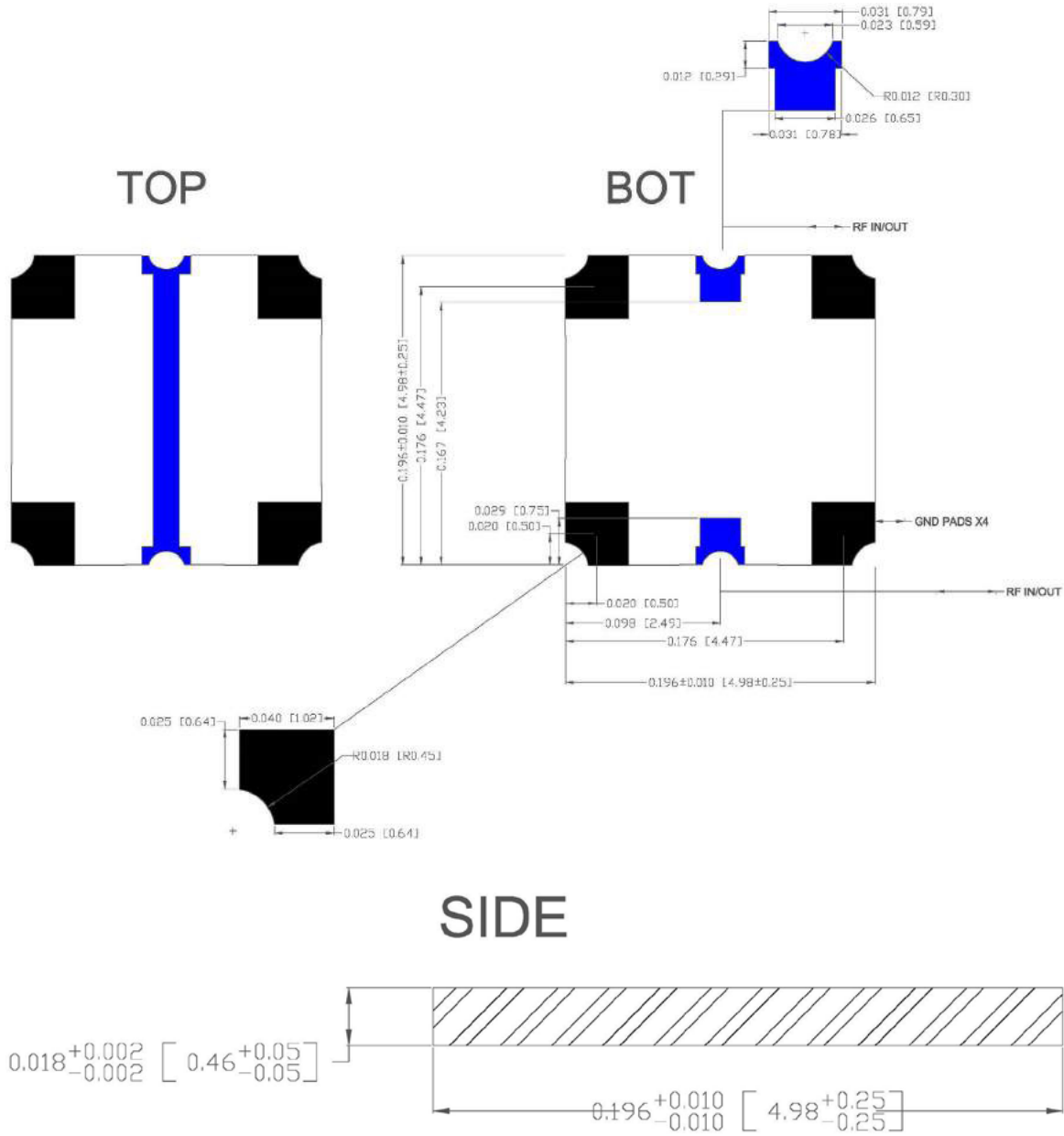

RF-DC SMT CROSSOVER PERFORMANCE: 0.3 GHZ TO 6 GHZ

RF/DC Crossover – Insertion Loss

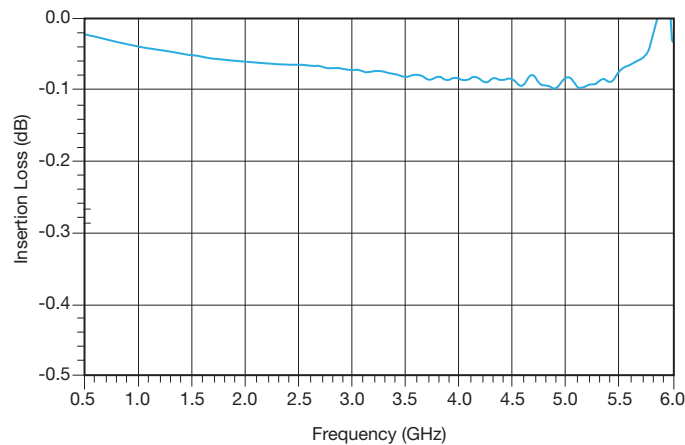

RF/DC Crossover – Return Loss

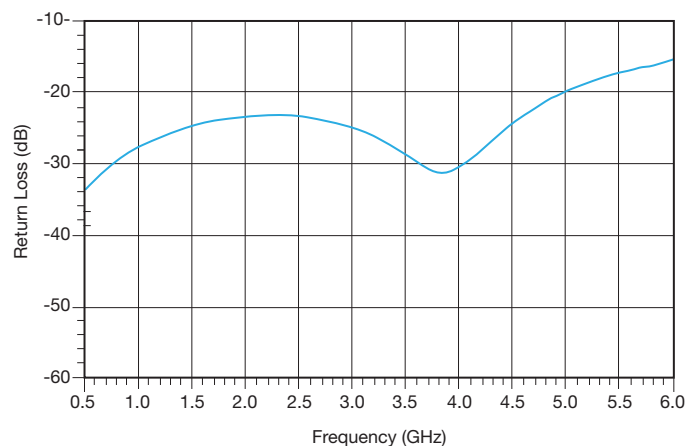

MOUNTING PROCEDURE

MLO® SMT crossovers require 50Ω transmission lines leading to and from all of the RF ports. Proper grounding is required in order to ensure optimal device performance. If these conditions are not met then performance parameters including insertion loss, return loss and any isolation may not meet published values. All of the MLO® components utilize castellated interconnects which allow for high yield assembly, expansion matched and halogen free dielectric. When mounting the user must be mindful of the following: a) ensure the RF pads of the device are in contact with the circuit trace of the printed circuit board and b) the ground plane of neither the component nor the PCB is in contact with the RF signal. Parts are specifically oriented in the tape and reel.

MOUNTING FOOTPRINT

To ensure proper electrical and thermal performance there must be a ground plane with 100% solder connection underneath the part.

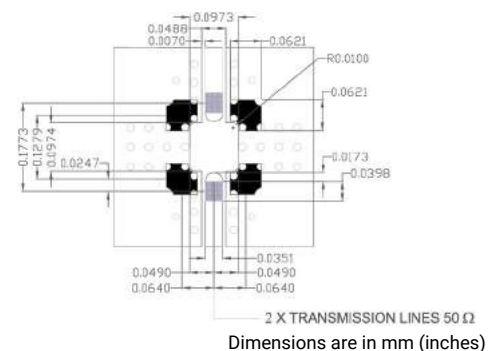

Multilayer Organic (MLO®) SMT Crossovers

RF-RF

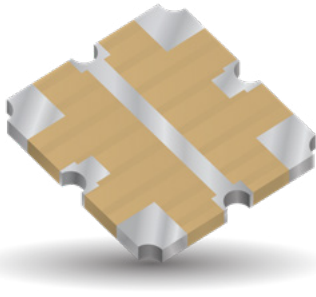

GENERAL DESCRIPTION

The MLO® SMT RF-RF Crossover is a very low profile crossover that intersects an RF and RF circuit trace in an SMT package. The RF-RF Crossover is a low cost solution for applications where a critical RF circuit trace intersects a RF circuit precluding the need for an expensive multilayer printed circuit board. The SMT package can support frequencies up to 6 GHz. MLO® crossovers have been subjected to JEDEC reliability standards and 100% electrically tested. The RF-RF crossovers are available in NiSn.

FEATURES

- DC – 6.0 GHz
- RF – RF Crossover
- Low Loss
- High Isolation
- Surface Mountable
- Tape and Reel
- 100% Tested

APPLICATIONS

- Military and Commercial Radar
- Medical Imaging Electronics
- Communications Transmitter
- Optical Drivers

LAND GRID ARRAY ADVANTAGES

- Inherent Low Profile
- Excellent Solderability
- Low Parasitics
- Better Heat Dissipation

TOP VIEW

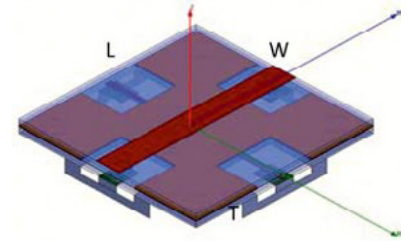

HOW TO ORDER

X2B	2020	RFRF	T
Series	Size	Type	Packaging
			T= 1000pcs T&R T/250 = 250pcs T&R B= Bulk



Frequency (GHz)	Port Impedance (ohms)	Ins. Loss (dB max)	Return Loss (dB min)	Isolation (dB min)	Power (Watts)	θ _{JC} (°C /Watts)	Operating Temperature (°C)
DC -2.5	50	0.05	20	50	30	150	-55 to +85
2.5 – 4.0	50	0.10	18	30	19	150	-55 to +85
4.0 – 6.0	50	0.15	10	20	9	150	-55 to +85

* Specification based on performance of component assembled properly on printed circuit board with 50Ω nominal impedance.

QUALITY INSPECTION

Finished parts are 100% tested for electrical parameters and visual characteristics.

TERMINATION

NiSn compatible with automatic soldering technologies: Pb free reflow, wave soldering, vapor phase and manual.

OPERATING TEMPERATURE

- 55°C to +85°C

Multilayer Organic (MLO®) SMT Crossovers

RF-RF

MECHANICAL OUTLINE

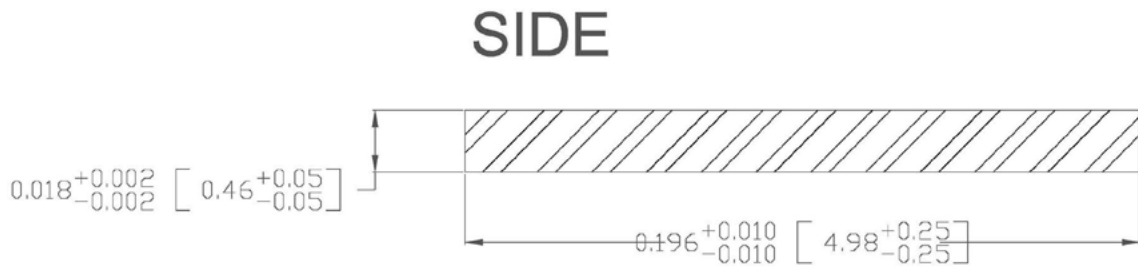
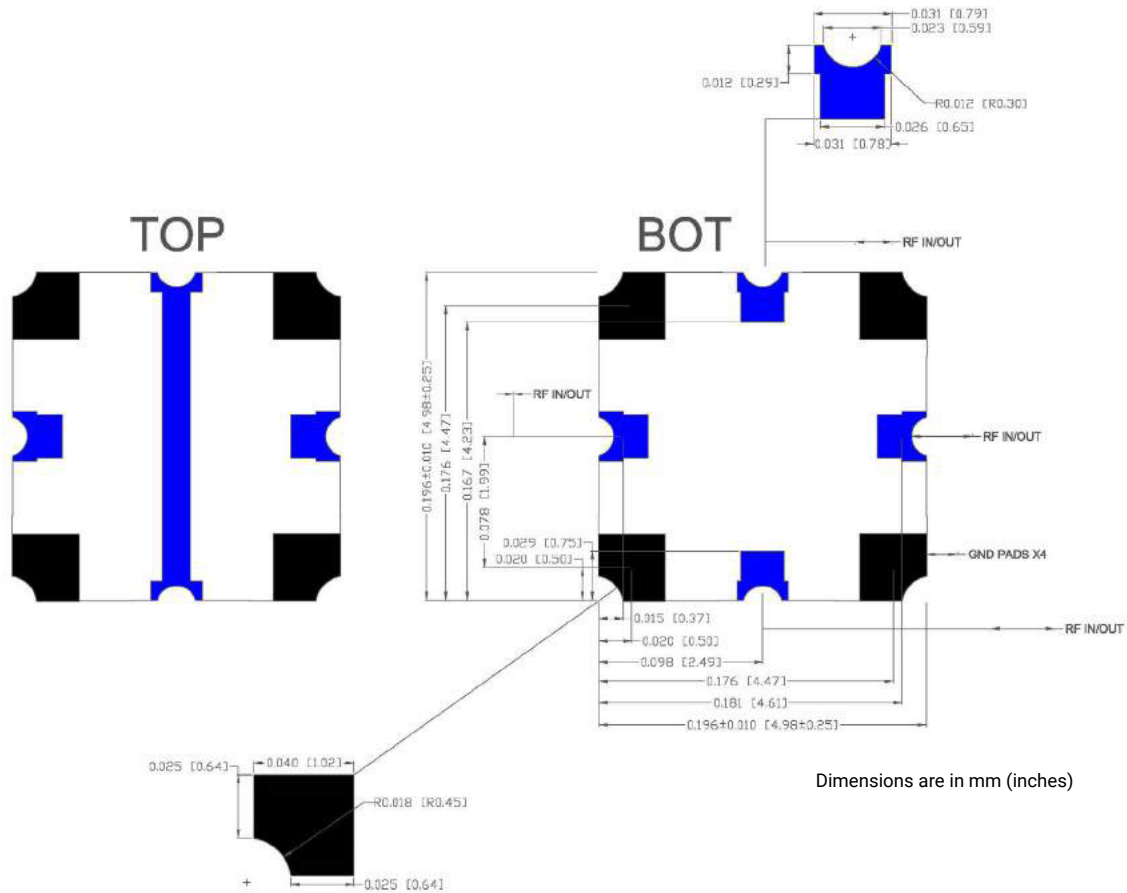

Multilayer Organic (MLO®) SMT Crossovers

RF-RF

RF-RF SMT CROSSOVER PERFORMANCE: 0.3 GHZ TO 6 GHZ

RF/RF Crossover – Insertion Loss

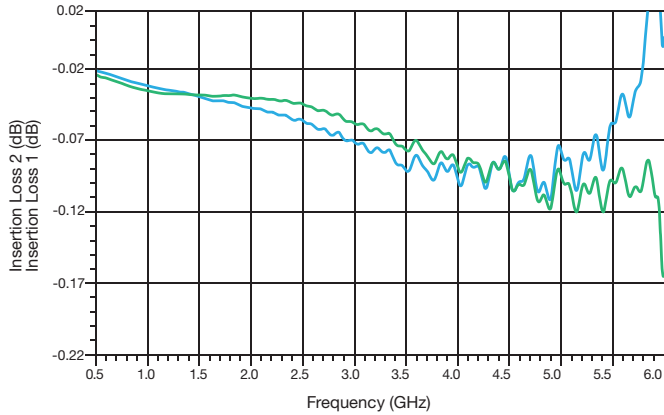

RF/RF Crossover – Return Loss

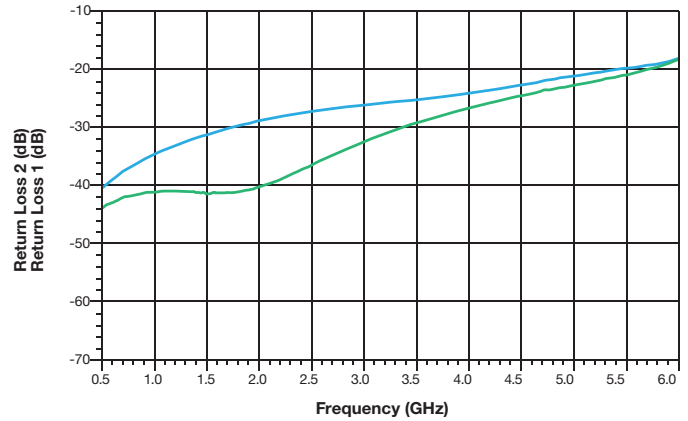

RF/RF Crossover – Isolation

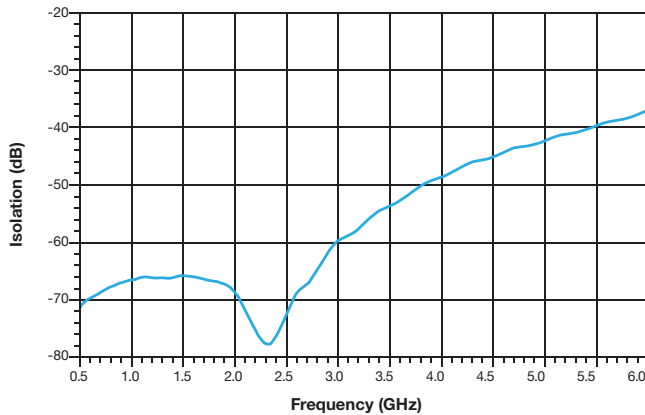

RF/RF Crossover – Phase Balance

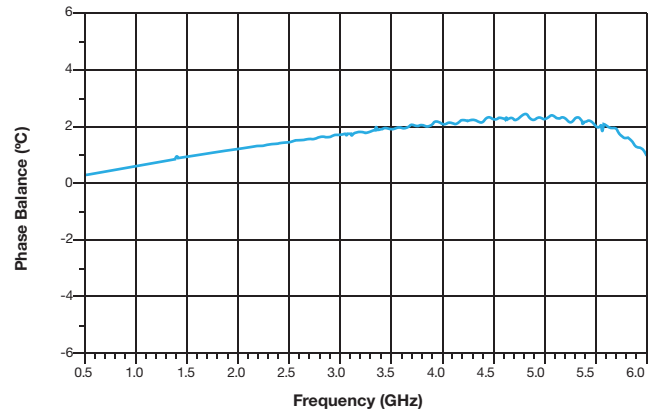

MOUNTING PROCEDURE

MLO® SMT crossovers require 50Ω transmission lines leading to and from all of the RF ports. Proper grounding is required in order to ensure optimal device performance. If these conditions are not met then performance parameters including insertion loss, return loss and any isolation may not meet published values. All of the MLO® components utilize castellated interconnects which allow for high yield assembly, expansion matched and halogen free dielectric. When mounting the user must be mindful of the following: a) ensure the RF pads of the device are in contact with the circuit trace of the printed circuit board and b) the ground plane of neither the component nor the PCB is in contact with the RF signal. Parts are specifically oriented in the tape and reel.

MOUNTING FOOTPRINT

To ensure proper electrical and thermal performance there must be a ground plane with 100% solder connection underneath the part.

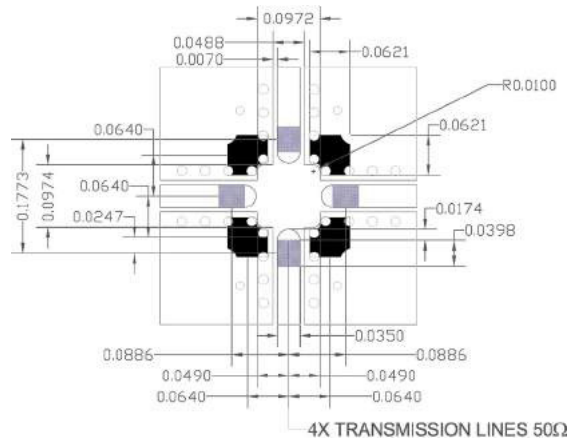

Dimensions are in mm (inches)

Multilayer Organic (MLO®) SMT Crossovers

Automated SMT Assembly/SMT Reflow Profile

AUTOMATED SMT ASSEMBLY

The following section describes the guidelines for automated SMT assembly of MLO® RF devices which are typically Land Grid Array (LGA) packages or side termination SMT packages.

Control of solder and solder paste volume is critical for surface mount assembly of MLO® RF devices onto the PCB. Stencil thickness and aperture

openings should be adjusted according to the optimal solder volume. The following are general recommendations for SMT mounting of MLO® devices onto the PCB.

SMT REFLOW PROFILE

Common IR or convection reflow SMT processes shall be used for the assembly. Standard SMT reflow profiles, for eutectic and Pb free solders, can be used to surface mount the MLO® devices onto the PCB. In all cases, a temperature gradient of 3°C/sec, or less, should be maintained to prevent warpage of the package and to ensure that all joints reflow properly. Additional soak time and slower preheating time may be required to improve

the out-gassing of solder paste. In addition, the reflow profile depends on the PCB density and the type of solder paste used. Standard no-clean solder paste is generally recommended. If another type of flux is used, complete removal of flux residual may be necessary. Example of a typical lead free reflow profile is shown below:

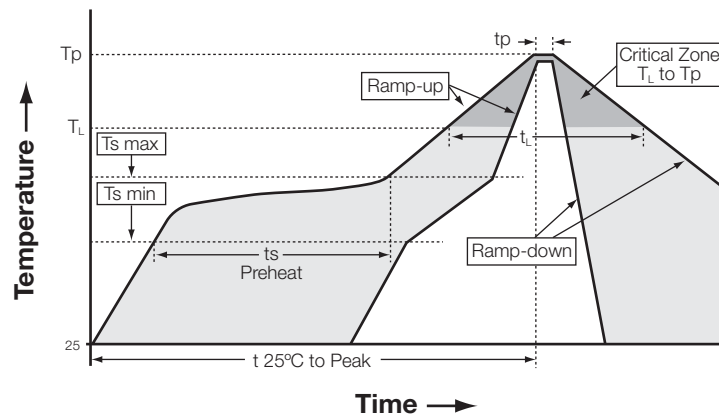

Profile Parameter	Pb free, Convection, IR/Convection
Ramp-up rate (Tsmax to Tp)	3°C/second max.
Preheat temperature (Ts min to Ts max)	150°C to 200°C
Preheat time (ts)	60 – 180 seconds
Time above T _L , 217°C (t _L)	60 – 120 seconds
Peak temperature (Tp)	260°C
Time within 5°C of peak temperature (tp)	10 – 20 seconds
Ramp-down rate	4°C/second max.
Time 25°C to peak temperature	6 minutes max.

RF/Microwave Inductors

AL Series – Air Core Inductors

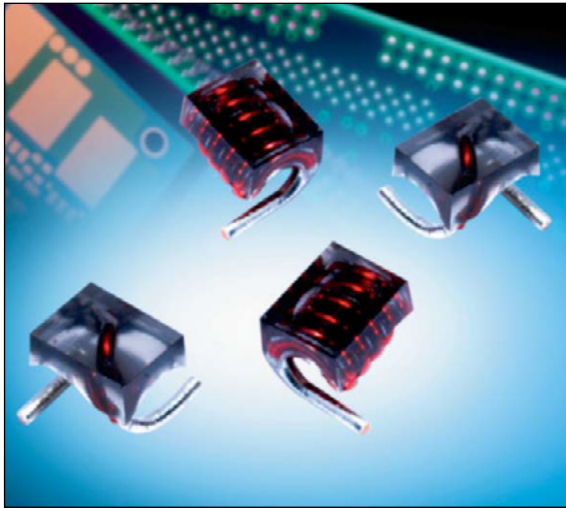

GENERAL DESCRIPTION

Air Core RF Inductors, part of the wound air core inductor family, are ideal for RF circuits, broadband I/O filtering, frequency selection, or impedance matching. The air core inductor provides better performance over solid core inductors with higher Q, and better current handling capabilities.

FEATURES

- Air Core Construction
- High Q
- High Current
- Excellent SRF
- Many inductance values ranging from 1.65nH to 538nH

APPLICATIONS

- RF Applications
- RF Circuits
- Broadband I/O Filtering
- Impedance Matching/Tuning
- Decoupling/Bypassing

HOW TO ORDER

AL ┆	05A ┆	02N5 ┆	G ┆	T ┆	R ┆		
Air Core Inductor	Size Size 05A = 0605 05B = 0605 12A = 1212 12B = 1212 016 = 1516 023 = 2523	Inductance 02N5 = 2.5nH 12N5 = 12.5nH 130N = 130nH	Tolerance G = 2% J = 5% K = 10%	Termination T = Sn/Ag over Cu (96.5% Sn, 3% Ag, 0.5% Cu)	Packaging R = 7" reel S = 13" reel* *AL016 & AL023 Only		

ELECTRICAL SPECIFICATIONS

Technical Data	All technical data related to an ambient temperature of +25°C
Inductance Range	1.65nH to 538nH
Inductance Tolerance	2%, 5%, 10%
Rated Current	1.5A to 4.0A
Operating Temperature	-40°C to +125°C
Termination	96.5% Tin/3% Silver over 0.5% Copper

RF Inductors

AL Series – Air Core Inductors

ELECTRICAL SPECIFICATIONS

Part Number	Turns	Inductance (nH)	Tolerance (%)	Q min.	Q typ.	Test Freq. (MHz)	DCR max (mΩ)	SRF GHz (min.)	Ir max Amps
AL05A1N65KTR	2	1.65	K	100	-	800	4	10	1.60
AL05A2N55*TR	3	2.55	J, K	100	-	800	5	8.2	1.60
AL05A3N85*TR	4	3.85	G, J, K	100	-	800	6	7.5	1.60
AL05A5N45*TR	5	5.45	G, J	100	-	800	8	7	1.60
AL05B05N6*TR	6	5.6	G, J	100	-	800	9	6.5	1.60
AL05B7N15*TR	7	7.15	G, J	100	-	800	10	6	1.60
AL05B08N8*TR	8	8.8	G, J	100	-	800	12	6	1.60
AL05B9N85*TR	9	9.85	G, J	100	-	800	13	5.2	1.60
AL05B12N5*TR	10	12.55	G, J	100	-	800	14	4.6	1.60
AL12A02N5KTR	1	2.5	K	145	-	150	1.1	12.5	4.00
AL12A05N0*TR	2	5	J, K	140	-	150	1.8	6.5	4.00
AL12A08N0*TR	3	8	G, J	140	-	150	2.6	5	4.00
AL12A12N5*TR	4	12.5	G, J	137	-	150	3.4	3.3	4.00
AL12A18N5*TR	5	18.5	G, J	132	-	150	3.9	2.5	4.00
AL12B17N5*TR	6	17.5	G, J	100	-	150	4.5	2.2	4.00
AL12B22N0*TR	7	22	G, J	102	-	150	5.2	2.1	4.00
AL12B28N0*TR	8	28	G, J	105	-	150	6	1.8	4.00
AL12B35N5*TR	9	35.5	G, J	112	-	150	6.8	1.5	4.00
AL12B43N0*TR	10	43	G, J	106	-	150	7.9	1.2	4.00
AL01622N0*TS	4	22	G, J	100	135	150	4.2	3.2	3.00
AL01627N0*TS	5	27	G, J	100	135	150	4	2.7	3.50
AL01633N0*TS	5	33	G, J	100	130	150	4.8	2.5	3.00
AL01639N0*TS	6	39	G, J	100	135	150	4.4	2.1	3.00
AL01647N0*TS	6	47	G, J	100	135	150	5.6	2.1	3.00
AL01656N0*TS	7	56	G, J	100	125	150	6.2	1.5	3.00
AL01668N0*TS	7	68	G, J	100	120	150	8.2	1.5	2.50
AL01682N0*TS	8	82	G, J	100	120	150	9.4	1.3	2.50
AL016100N*TS	9	100	G, J	100	115	150	12.3	1.2	1.70
AL016120N*TS	9	120	G, J	100	125	150	17.3	1.1	1.50
AL02390N0*TS	9	90	G, J	95	114	50	15	1.140	3.50
AL023111N*TS	10	111	G, J	87	104	50	15	1.020	3.50
AL023130N*TS	11	130	G, J	87	104	50	20	0.900	3.00
AL023169N*TS	12	169	G, J	95	114	50	25	0.875	3.00
AL023206N*TS	13	206	G, J	95	114	50	30	0.800	3.00
AL023222N*TS	14	222	G, J	92	110	50	35	0.730	3.00
AL023246N*TS	15	246	G, J	95	114	50	35	0.685	3.00
AL023307N*TS	16	307	G, J	95	114	50	35	0.660	3.00
AL023380N*TS	17	380	G, J	95	114	50	50	0.590	2.50
AL023422N*TS	18	422	G, J	95	114	50	60	0.540	2.50
AL023491N*TS	19	491	G, J	95	114	50	65	0.535	2.00
AL023538N*TS	20	538	G, J	87	104	50	90	0.490	2.00

*Tolerance: G= ± 2%, J: ± 5%, K: ± 10%

- a. Test Equipment:
L/Q: HP-4291B With HP16193A test fixture or equivalent.
SRF: HP8753E /HP8720D or equivalent.
RDC: Chroma 16502 or equivalent.
- b. Operating temperature range: -40°C to +125°C.
- c. For Temperature Rise: 15°C
- d. Storage Temp.: -40°C to +85°C.
- e. MSL: Level 1

RF Inductors

AL Series – Air Core Inductors

PHYSICAL DIMENSIONS

AL12A, AL12B, AL016, AL023

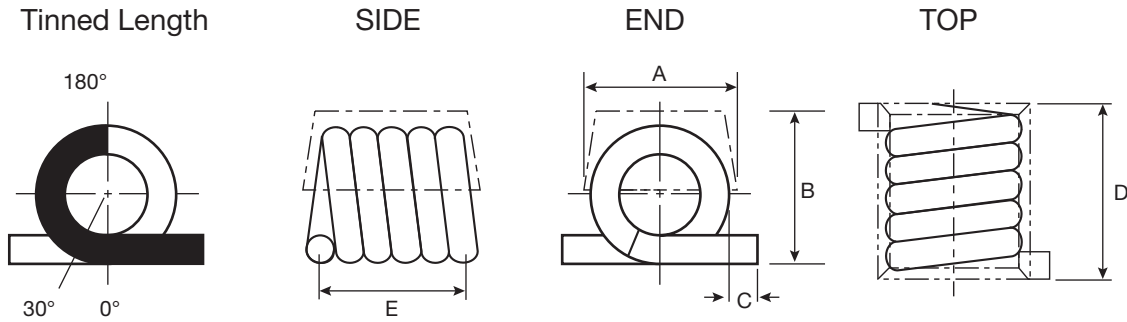

AL05A, AL05B

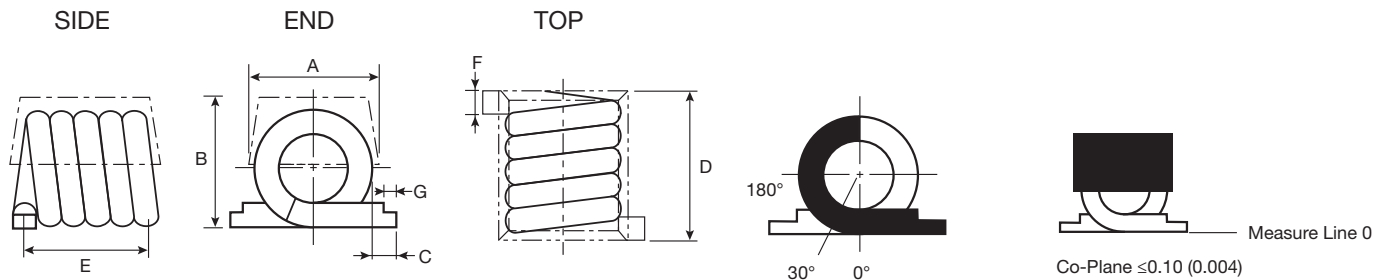

TINNED LENGTH BETWEEN 30° AND 180°

mm (inches)

Part Number	A	B	C	D	E	F	G
AL05A	1.42 ± 0.13 (0.056 ± 0.005)	1.37 ± 0.15 (0.056 ± 0.005)	0.89 ± 0.25 (0.035 ± 0.010)	2.21 ± 0.25 (0.087 ± 0.010)	1.83 ± 0.25 (0.072 ± 0.010)	0.51 max. (0.200 max.)	0.35 min. (0.014 min.)
AL05B	1.42 ± 0.13 (0.056 ± 0.005)	1.37 ± 0.15 (0.056 ± 0.005)	0.89 ± 0.25 (0.035 ± 0.010)	4.04 ± 0.30 (0.159 ± 0.012)	3.66 ± 0.30 (0.144 ± 0.012)	0.51 max. 0.200 max.	0.35 min. 0.014 min.
AL12A	3.05 max. (0.120 max.)	3.18 max. (0.125 max.)	0.58 ± 0.38 (0.023 ± 0.015)	3.68 max. (0.145 max.)	2.92 ± 0.25 (0.115 ± 0.010)	-	-
AL12B	3.05 max. (0.120 max.)	3.18 max. (0.125 max.)	0.58 ± 0.38 (0.023 ± 0.015)	6.86 max. (0.270 max.)	5.84 ± 0.25 (0.230 ± 0.010)	-	-
AL016	3.81 (0.150)	4.20 max. (0.165 max.)	1.53 ± 0.39 (0.060 ± 0.015)	4.83 max. (0.190 max.)	4.32 ± 0.39 (0.170 ± 0.015)	-	-
AL023	6.35 max. (0.250 max.)	5.90 max. (0.232 max.)	1.02 ± 0.39 (0.040 ± 0.015)	10.55 max. (0.415 max.)	7.98 ± 0.51 (0.314 ± 0.020)	-	-

RECOMMENDED LAND PATTERNS

MM (INCHES)

Part Number	A	B	C	D	E
AL05A	2.62 (0.103)	2.46 (0.097)	1.04 (0.041)	1.02 (0.040)	0.79 (0.031)
AL05B	4.45 (0.175)	2.46 (0.097)	2.87 (0.113)	1.02 (0.040)	0.79 (0.031)
AL12A	4.19 (0.165)	3.30 (0.130)	1.65 (0.065)	2.79 (0.110)	1.27 (0.050)
AL12B	7.24 (0.285)	3.30 (0.130)	4.70 (0.185)	2.79 (0.110)	1.27 (0.050)
AL016	5.80 (0.228)	5.16 (0.203)	2.85 (0.112)	2.62 (0.103)	1.48 (0.058)
AL023	10.0 (0.394)	4.70 (0.185)	5.95 (0.234)	2.42 (0.095)	2.04 (0.080)

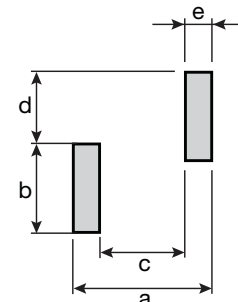

RF Inductors

AL Series – Air Core Inductors

PERFORMANCE SPECIFICATIONS

Inductance vs. Frequency

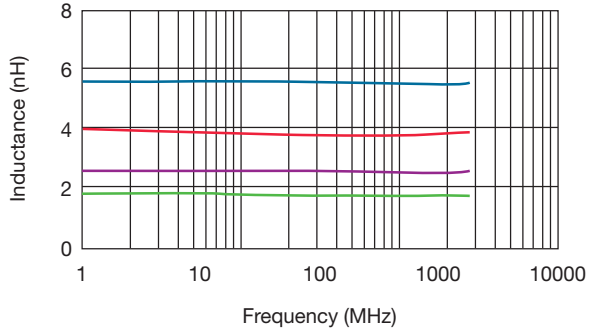

AL05A

Typical Q vs. Frequency

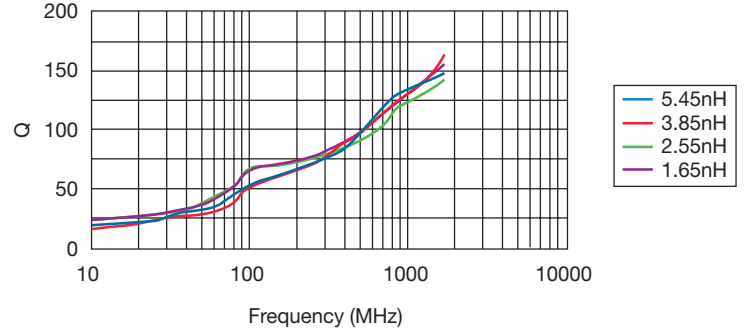

Inductance vs. Frequency

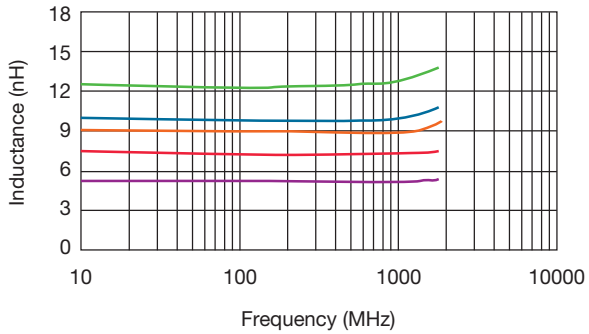

AL05B

Typical Q vs. Frequency

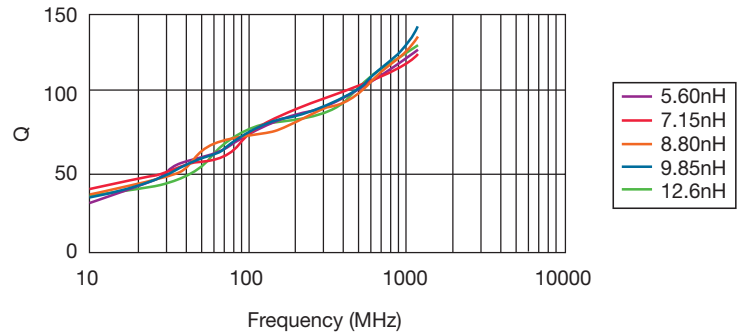

Inductance vs. Frequency

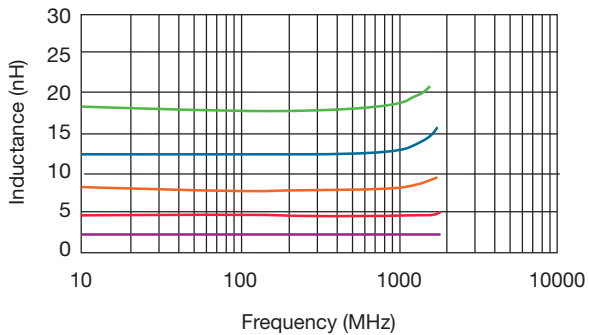

AL12A

Typical Q vs. Frequency

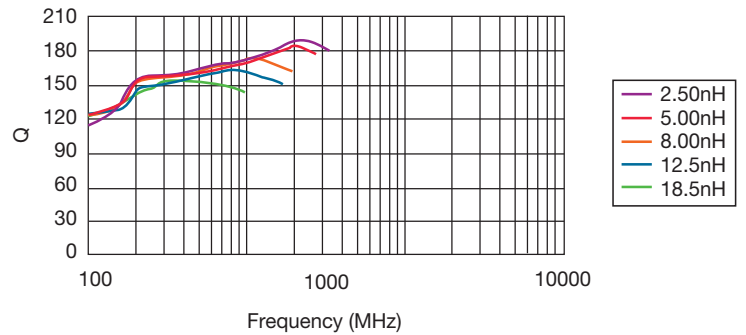

RF Inductors

AL Series – Air Core Inductors

PERFORMANCE SPECIFICATIONS

AL12B

Inductance vs. Frequency

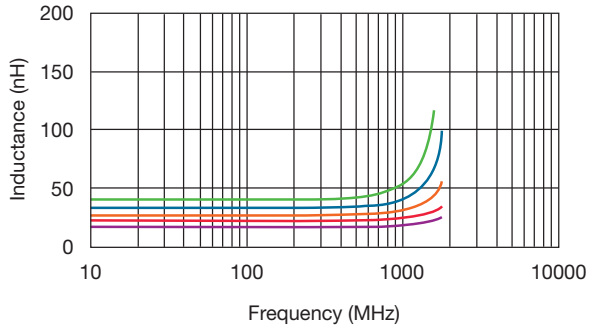

Typical Q vs. Frequency

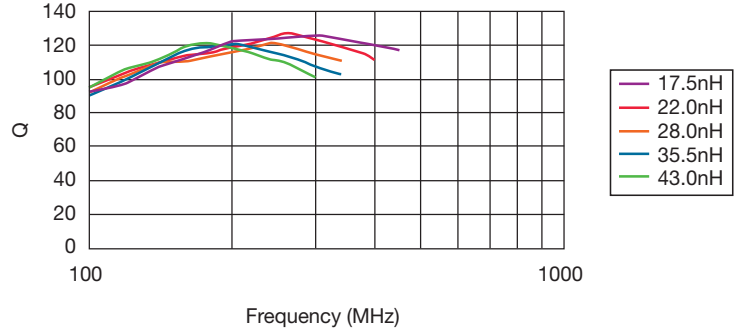

AL016

Inductance vs. Frequency

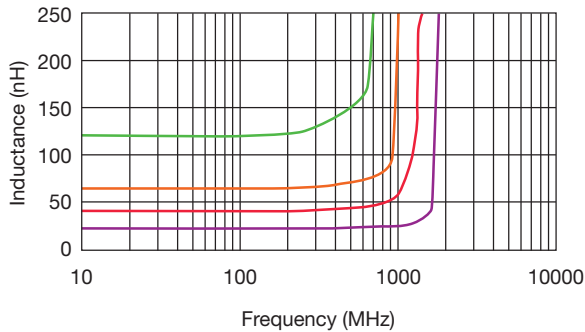

Typical Q vs. Frequency

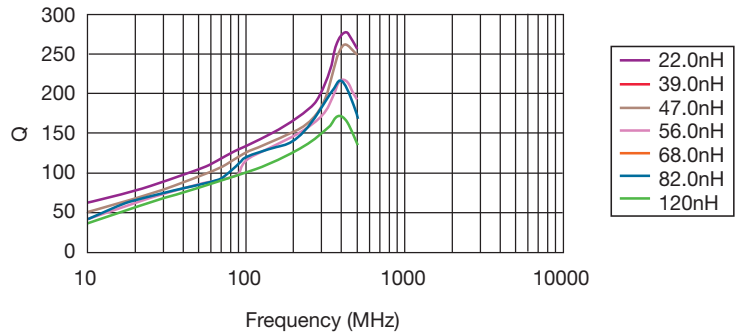

AL023

Inductance vs. Frequency

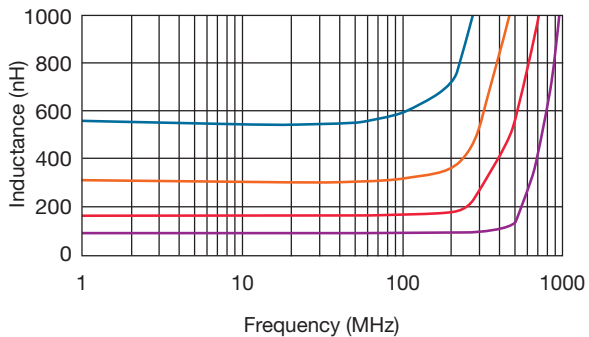

Typical Q vs. Frequency

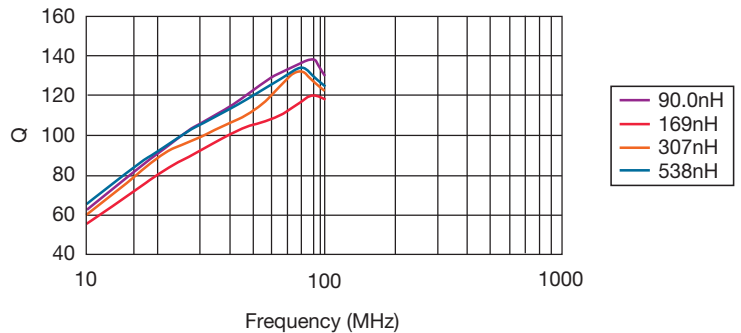

RF Inductors

AL Series – Air Core Inductors

TYPICAL ROHS REFLOW PROFILE

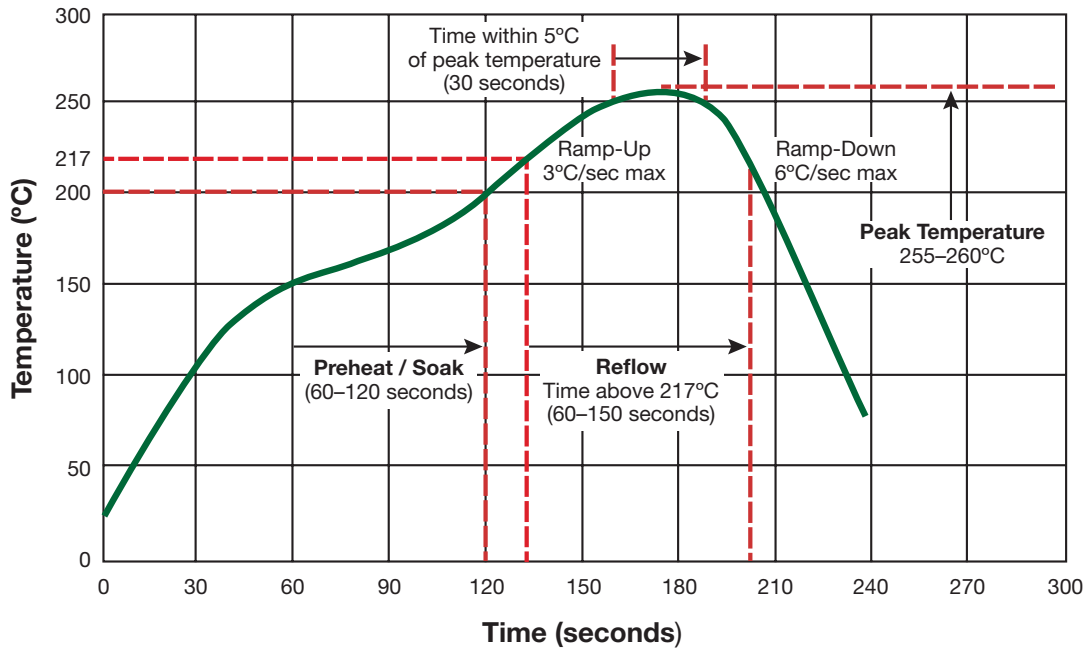

RF Inductors

AL Series – Air Core Inductors

PACKAGING SPECIFICATIONS

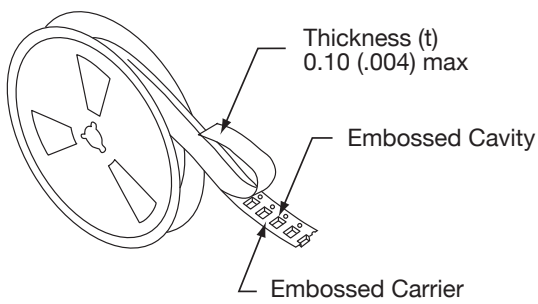

- The force for tearing off cover tape is 10 to 130 grams in the arrow direction

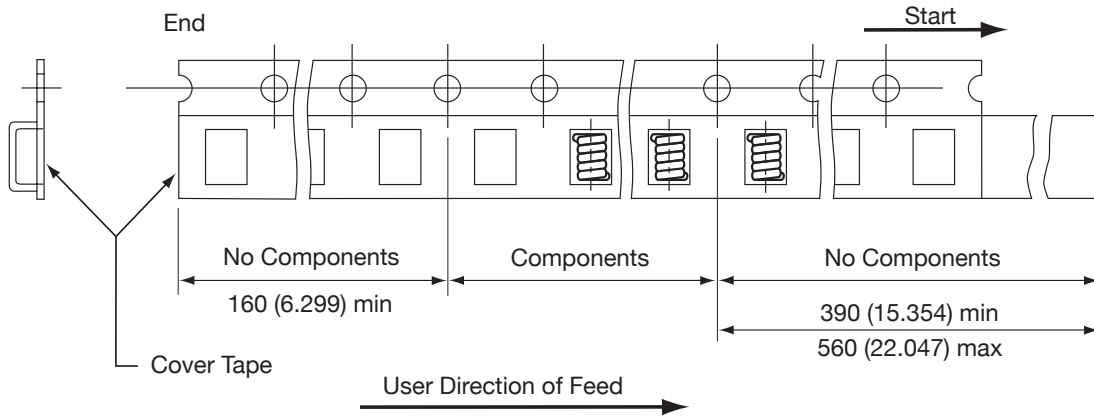
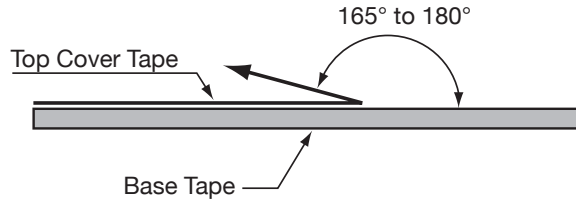

CARRIER TAPE REELS

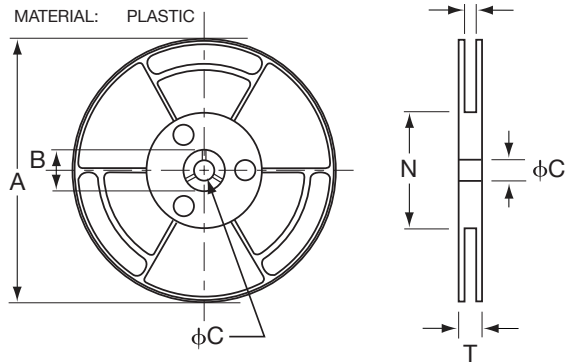

DIMENSIONS OF CARRIER TAPE

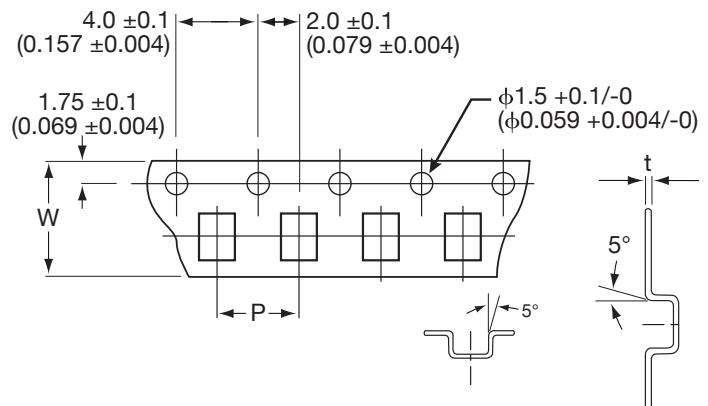

mm (inches)

Series	ITEM	A	B	C	N	G	T	W	P	t
AL05A	DIM.	178	21	13	75	8.4	12.5	8	4	0.30
	TOL.	±2.0	±0.8	±0.8	±2.0	+1.5	+1.5	±0.3	±0.1	±0.05
AL05B	DIM.	180	21	13	50	12.4	18.4	12	4	0.35
	TOL.	MAX	±0.8	+0.5/-0.2	MIN	+2.0	MAX	±0.30	±0.10	±0.05
AL12A	DIM.	178	25	15	75	12.5	16.4	12	8	0.25
	TOL.	±2.0	±1.0	±0.5	±2.0	+1.5	+1.5	±0.2	±0.1	±0.05
AL12B	DIM.	178	50	15	75	16.5	20.4	16	8	0.25
	TOL.	±2.0	±1.0	±0.5	±2.0	+1.5	+1.5	±0.2	±0.1	±0.05
AL016	DIM.	340	20.2	13	100	16.5	25.5	16	12	0.30
	TOL.	MAX	MIN	±0.5	REF	±0.5	±0.5	±0.30	±0.10	±0.05
AL023	DIM.	340	20.2	13	100	24.5	30.4	24.0	12.0	0.35
	TOL.	MAX	MIN	±0.5	REF	±0.5	±0.5	±0.30	±0.10	±0.05

RF Inductors

AS Series – Square Air Core Inductors

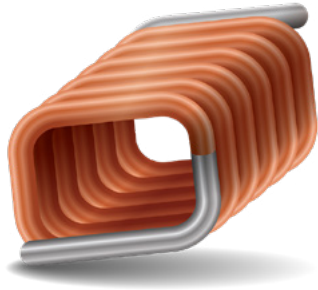

GENERAL DESCRIPTION

Square Air Core RF Inductors, part of the wound air core inductor family, are ideal for RF circuits, broadband I/O filtering, frequency selection, or impedance matching. The unique square cross section of the air core inductor provides better performance, and offers manufacturing advantages over toroidal coils.

FEATURES

- Square cross section construction
- Available in 0806, 0807, and 0908 sizes
- 20 Inductance values ranging from 5.5nH to 27.3nH
- High Q
- High Current
- Excellent SRF

APPLICATIONS

- RF Applications
- RF Circuits
- Broadband I/O Filtering
- Impedance Matching

HOW TO ORDER

AS	06	05N5	J	T	R		
Air Core Inductor (Square Cross Section)	Size 06 = 0806 07 = 0807 08 = 0908	Inductance 05N5 = 5.5nH 06N0 = 6.0nH 12N3 = 12.3nH	Tolerance G = 2% J = 5% K = 10%	Termination T = Sn/Ag over Cu (96.5% Sn, 3% Ag, 0.5% Cu)	Packaging R = 7 inch reel (2000 pieces per reel)		

ELECTRICAL SPECIFICATIONS

Technical Data	All technical data related to an ambient temperature of +25°C
Inductance Range	5.5nH to 27.3nH
Inductance Tolerance	2%, 5%, 10%
Rated Current	2.7A, 2.9A, 4.4A
Operating Temperature	-40°C to +125°C
Termination	96.5% Tin/3% Silver over 0.5% Copper

ELECTRICAL SPECIFICATIONS

Part Number	Turns	Inductance (nH)	Tolerance (%)	Q min.	Test Freq. (MHz)	DCR max (mΩ)	SRF (GHz)	I _r max (A)
AS0605N5*TR	3	5.5	G, J, K	60	400	3.4	4.9	2.9
AS0606N0*TR	3	6	G, J, K	64	400	6.0	5.2	2.9
AS0608N9*TR	4	8.9	G, J, K	90	400	7.0	4.3	2.9
AS0612N3*TR	5	12.3	G, J, K	90	400	8.0	4.8	2.9
AS0615N7*TR	6	15.7	G, J, K	90	400	9.0	4.4	2.9
AS0619N4*TR	7	19.4	G, J, K	90	400	10.0	4	2.9
AS0706N9*TR	3	6.9	G, J, K	100	400	6.0	4.6	2.7
AS0710N2*TR	4	10.2	G, J, K	100	400	7.0	4	2.7
AS0711N2*TR	4	11.2	G, J, K	90	400	6.3	3.6	2.7
AS0713N7*TR	5	13.7	G, J, K	100	400	8.0	4.3	2.7
AS0717N0*TR	6	17	G, J, K	100	400	9.0	4	2.7
AS0722N0*TR	7	22	G, J, K	100	400	10.0	3.5	2.7
AS0808N1*TR	3	8.1	G, J, K	130	400	6.0	5.2	4.4
AS0812N1*TR	4	12.1	G, J, K	130	400	7.0	4.3	4.4
AS0814N7*TR	4	14.7	G, J, K	90	400	7.2	3	4.4
AS0816N6*TR	5	16.6	G, J, K	130	400	8.0	3.4	4.4
AS0821N5*TR	6	21.5	G, J, K	130	400	9.0	3.7	4.4
AS0823N0*TR	6	23	G, J, K	130	400	10.0	2.6	4.4
AS0825N0*TR	7	25	G, J, K	130	400	10	2.5	4.4
AS0827N3*TR	7	27.3	G, J, K	130	400	10	3.2	4.4

Note: 1. *Tolerance: G=±2%, J=±5%, K=±10%
 2. Inductance & Q measured on the HP4291B. With HP16193A test fixture.
 3. SRF measured using the HP8753E
 4. Operating Temperature range: -40°C to +125°C
 5. Electrical Specifications at 25°C
 6. MSL: Level 1

RF Inductors

AS Series – Square Air Core Inductors

PHYSICAL DIMENSIONS

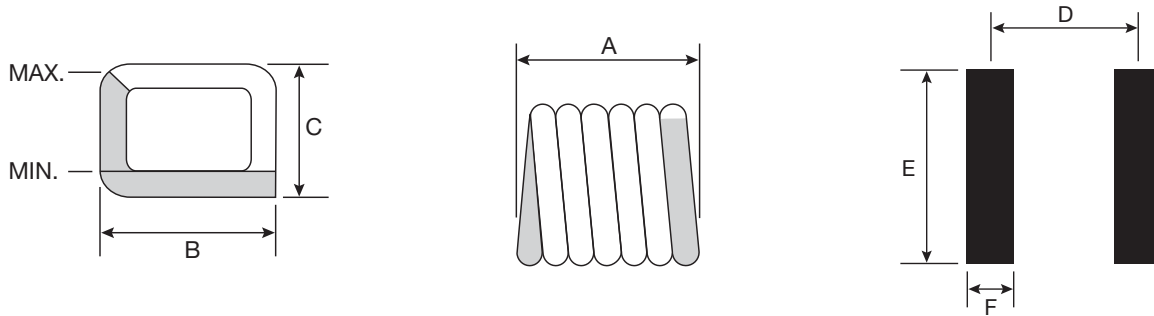

mm (inches)

Part Number	A	B	C	D	E	F
AS0605N5*TR	1.346±0.102 (0.053±0.004)	1.829±0.254 (0.072±0.01)	1.397±0.102 (0.055±0.004)	0.962 (0.038)	2.60 (0.102)	0.51 (0.020)
AS0606N0*TR	1.295±0.102 (0.051±0.004)	1.829±0.254 (0.072±0.01)	1.397±0.102 (0.055±0.004)	0.99 (0.390)	2.60 (0.102)	0.51 (0.020)
AS0608N9*TR	1.626±0.152 (0.640±0.006)	1.829±0.254 (0.072±0.01)	1.397±0.102 (0.055±0.004)	1.27 (0.050)	2.60 (0.102)	0.51 (0.020)
AS0612N3*TR	1.930±0.152 (0.076±0.006)	1.829±0.254 (0.072±0.01)	1.397±0.102 (0.055±0.004)	1.63 (0.064)	2.60 (0.102)	0.51 (0.020)
AS0615N7*TR	2.286±0.152 (0.09±0.006)	1.829±0.254 (0.072±0.01)	1.397±0.102 (0.055±0.004)	1.96 (0.070)	2.60 (0.102)	0.51 (0.020)
AS0619N4*TR	2.591±0.152 (0.102±0.006)	1.829±0.254 (0.072±0.01)	1.397±0.102 (0.055±0.004)	2.29 (0.090)	2.60 (0.102)	0.51 (0.020)
AS0706N9*TR	1.295±0.102 (0.051±0.004)	1.829±0.254 (0.072±0.01)	1.524±0.254 (0.060±0.010)	1.02 (0.040)	2.60 (0.102)	0.51 (0.020)
AS0710N2*TR	1.626±0.152 (0.064±0.006)	1.829±0.254 (0.072±0.01)	1.524±0.254 (0.060±0.010)	1.32 (0.052)	2.60 (0.102)	0.51 (0.020)
AS0711N2*TR	1.549±0.152 (0.061±0.006)	1.829±0.254 (0.072±0.01)	1.524±0.254 (0.060±0.010)	1.24 (0.049)	2.60 (0.102)	0.51 (0.020)
AS0713N7*TR	1.930±0.152 (0.076±0.006)	1.829±0.254 (0.072±0.01)	1.524±0.254 (0.060±0.010)	1.57 (0.062)	2.60 (0.102)	0.51 (0.020)
AS0717N0*TR	2.286±0.152 (0.09±0.006)	1.829±0.254 (0.072±0.01)	1.524±0.254 (0.060±0.010)	1.93 (0.076)	2.60 (0.102)	0.51 (0.020)
AS0722N0*TR	2.591±0.152 (0.102±0.006)	1.829±0.254 (0.072±0.01)	1.524±0.254 (0.060±0.010)	2.29 (0.090)	2.60 (0.102)	0.51 (0.020)
AS0808N1*TR	1.473±0.152 (0.058±0.006)	2.134±0.152 (0.084±0.006)	1.829±0.152 (0.072±0.006)	1.12 (0.044)	2.80 (0.110)	0.64 (0.025)
AS0812N0*TR	1.854±0.152 (0.073±0.006)	2.134±0.152 (0.084±0.006)	1.829±0.152 (0.072±0.006)	1.45 (0.570)	2.80 (0.110)	0.64 (0.025)
AS0814N7*TR	1.549±0.152 (0.061±0.006)	2.134±0.152 (0.084±0.006)	1.829±0.152 (0.072±0.006)	1.24 (0.049)	2.80 (0.110)	0.64 (0.025)
AS0816N6*TR	2.210±0.152 (0.087±0.006)	2.134±0.152 (0.084±0.006)	1.829±0.152 (0.072±0.006)	1.83 (0.072)	2.80 (0.110)	0.64 (0.025)
AS0821N5*TR	2.565±0.152 (0.101±0.006)	2.134±0.152 (0.084±0.006)	1.829±0.152 (0.072±0.006)	2.18 (0.086)	2.80 (0.110)	0.64 (0.025)
AS0823N0*TR	2.235±0.152 (0.088±0.006)	2.134±0.152 (0.084±0.006)	1.829±0.152 (0.072±0.006)	1.90 (0.075)	2.80 (0.110)	0.64 (0.025)
AS0825N0*TR	2.972±0.152 (0.117±0.006)	2.134±0.152 (0.084±0.006)	1.829±0.152 (0.072±0.006)	2.57 (0.101)	2.80 (0.110)	0.64 (0.025)
AS0827N3*TR	2.972±0.152 (0.117±0.006)	2.134±0.152 (0.084±0.006)	1.829±0.152 (0.072±0.006)	2.57 (0.101)	2.80 (0.110)	0.64 (0.025)

RF Inductors

AS Series – Square Air Core Inductors

RELIABILITY PERFORMANCE

RELIABILITY EXPERIMENT FOR ELECTRICAL

Test Item	Accept Criteria	Test Condition	Standard Source
Humidity Test	1. Change from an initial value L: within $\pm 5\%$ 2. no visible damage.	$+40^{\circ}\text{C} \pm 2^{\circ}\text{C}$, humidity of $90\% \pm 5\%$ (total 96 hours).	MIL-STD-202G Method 103B Test Condition B
High Temperature Test	1. Change from an initial value L: within $\pm 5\%$ 2. no visible damage.	1. Temperature: $+125^{\circ}\text{C} \pm 2^{\circ}\text{C}$. 2. Test time: 48 ± 2 hrs.	IEC 68-2 Test Condition B
Low Temperature Test	1. Change from an initial value L: within $\pm 5\%$ 2. no visible damage.	1. Temperature: $-25^{\circ}\text{C} \pm 2^{\circ}\text{C}$. 2. Test time: 48 ± 2 hrs.	IEC 68-2 Test Condition A
Thermal Shock	1. Change from an initial value L: within $\pm 5\%$ 2. no visible damage.	$+125^{\circ}\text{C} \pm 5^{\circ}\text{C}$ (30 minutes) ~ $-55^{\circ}\text{C} \pm 5^{\circ}\text{C}$ (30 minutes), temperature switch time: 5 minutes (total 50 cycles) Wind speeds 10m/sec .	Reference MIL-STD-202G Method 107G Test Condition A-2
Life Test	1. Change from an initial value L: within $\pm 5\%$ 2. no visible damage.	$+70^{\circ}\text{C} \pm 5^{\circ}\text{C}$ (250Hours).	Reference MIL-STD-202G Method 108A Test Condition B

RELIABILITY EXPERIMENT FOR PHYSICAL

Test Item	Accept Criteria	Test Condition	Standard Source
Vibration Test	1. Change from an initial value L: within $\pm 5\%$ 2. no visible damage.	10-55-10HZ, amplitude: 1.5mm, direction: X, Y, Z axes, each axis 2 hours (total 6 hours).	MIL-STD-202G Method 201A
Soldering Heat Resistance Test	1. no visible damage.	IR/convection reflow: Peak Temp $255^{\circ}\text{C} \sim 260^{\circ}\text{C}$ for 3~5 Sec. in air, Through 2 Cycle. Temperature Ramp: $+1 \sim 4^{\circ}\text{C/sec}$; Above 217°C , must keep 90 s - 120 s.	Reference: MIL-STD-202G Method 210F Test Condition K (Reflow)
Solder Ability Test	1. Lead must have 95% above coverage.	Soak in 245°C solder pot of 3~5 Sec.	Reference: J-STD-002D

RF Inductors

AS Series – Square Air Core Inductors

PERFORMANCE SPECIFICATIONS

AS06

Inductance vs. Frequency

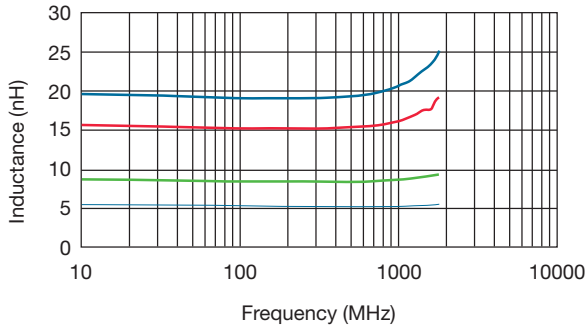

Typical Q vs. Frequency

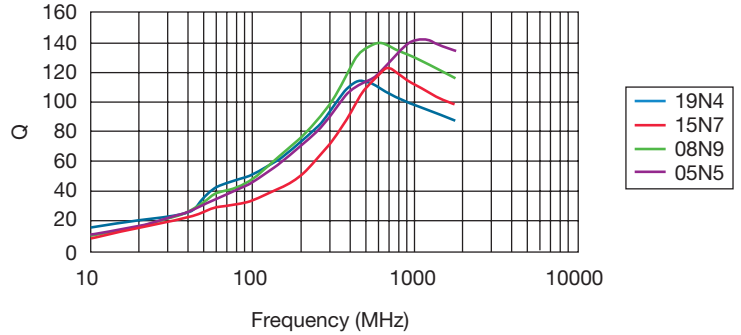

AS07

Inductance vs. Frequency

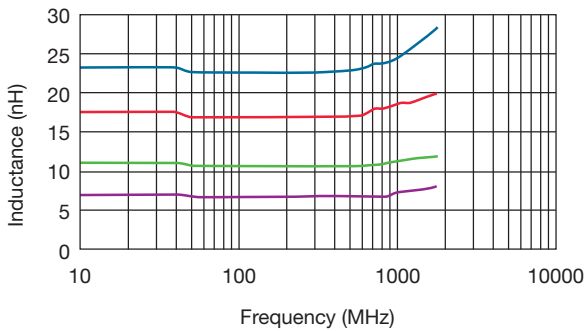

Typical Q vs. Frequency

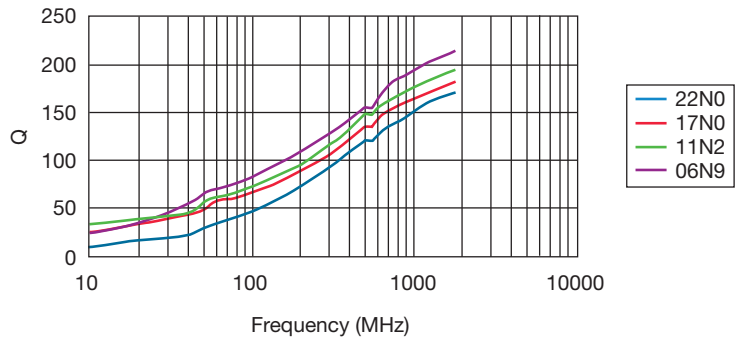

AS08

Inductance vs. Frequency

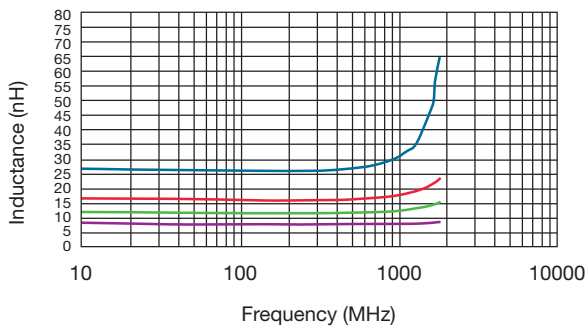

Typical Q vs. Frequency

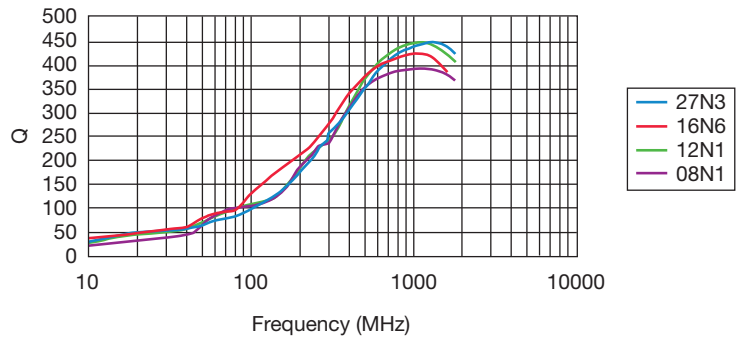

RF Inductors

AS Series – Square Air Core Inductors

TYPICAL ROHS REFLOW PROFILE

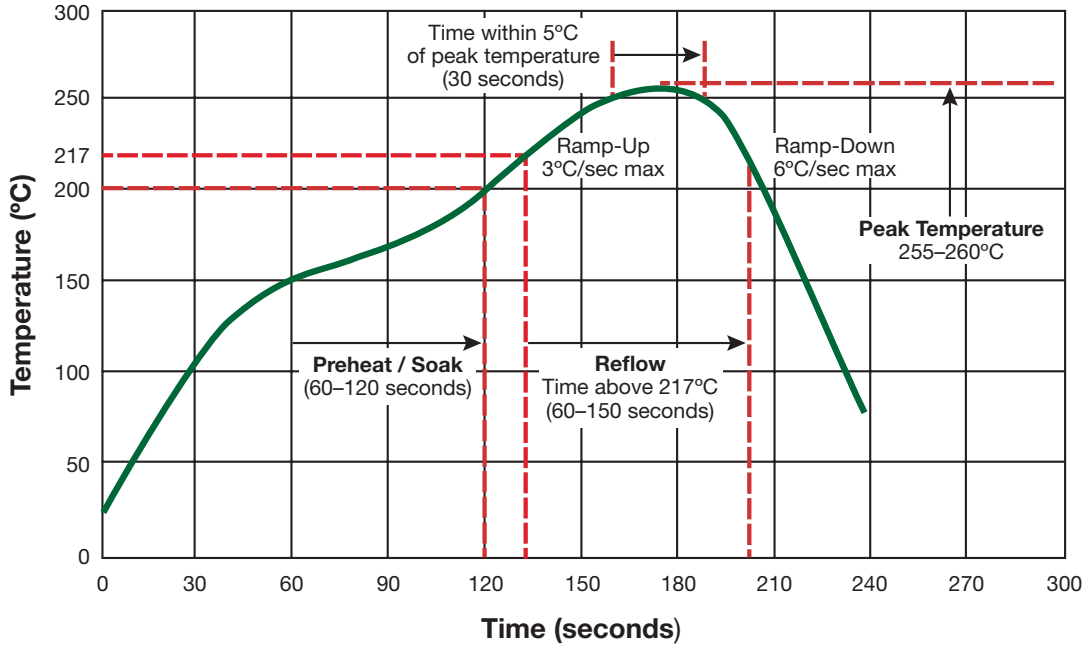

Test Condition	Standard Source
IR/convection reflow: Peak Temp 255°C ~260°C for 3~5 sec. in air, through 3 Cycle. Temperature Ramp: +1~4°C/sec.; Above 217°C, must keep 90 s -120 s.	Reference MIL-STD 202G Method 210F Test Condition K (Reflow)

PACKAGING SPECIFICATIONS

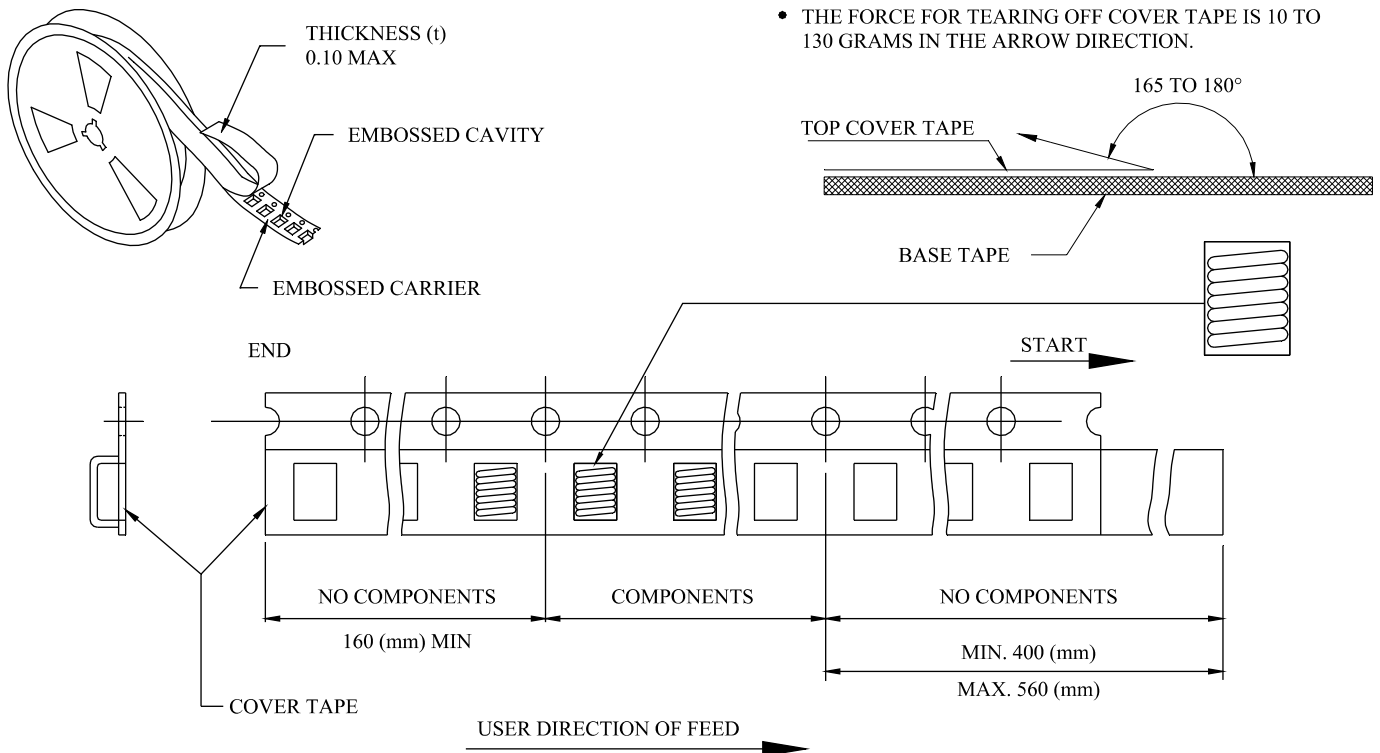

RF Inductors

AS Series – Square Air Core Inductors

CARRIER TAPE REELS

DIMENSIONS OF CARRIER TAPE

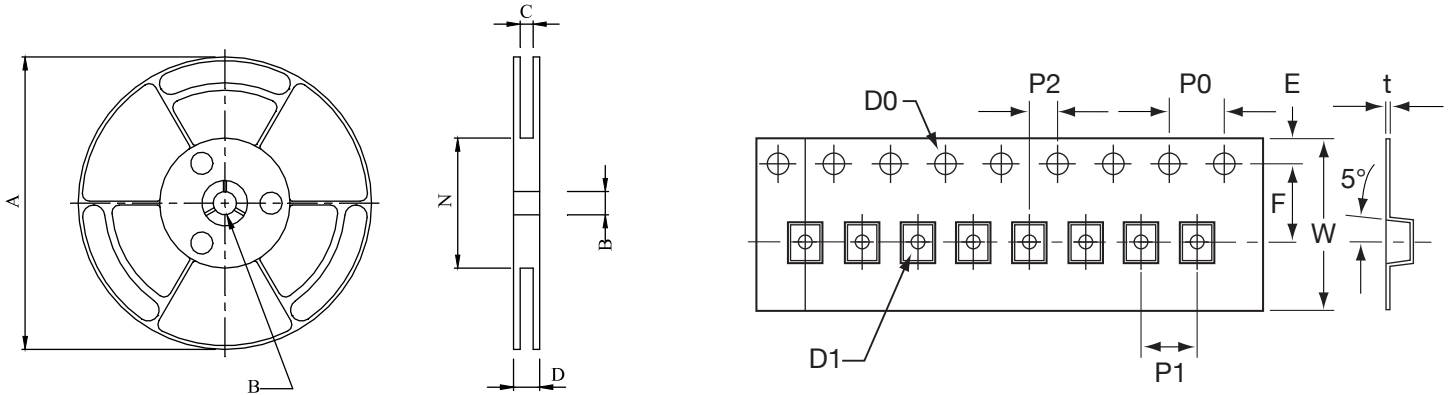

mm (inches)

ITEM	A	B	C	G	N	T	W	E	F	P1	P2	P0	D0	D1	t
DIM.	178 (7.008)	25 (0.984)	15 (0.591)	12.5 (0.492)	75 (2.953)	16.4 (0.646)	12.0 (0.472)	1.75 (0.069)	5.50 (0.217)	4.00 (0.157)	2.0 (0.079)	4.0 (0.157)	1.5 (0.059)	1.0 (0.039)	0.23 (0.009)
TOL.	±2.0 (0.079)	±1.0 (0.039)	±0.5 (0.020)	+1.5 (0.059)	±2.0 (0.079)	+1.5 (0.059)	±0.2 (0.008)	±0.1 (0.004)	±0.1 (0.004)	±0.1 (0.004)	±0.1 (0.004)	±0.1 (0.004)	+0.1 (0.004)	±0.1 (0.004)	±0.05 (0.020)

RF Inductors

LCWC Series – Wire Wound Chip Inductor

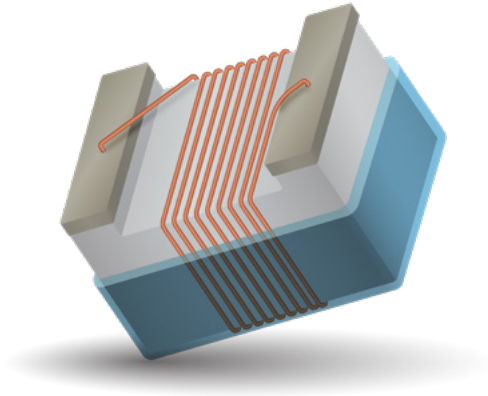

GENERAL DESCRIPTION

The LCWC series of wire wound ceramic inductors includes ultra-compact inductors that provide high Q factors, with a high current range available. LCWC is used in RF products such as cellular phones (CDMA/GSM/PHS), cordless phones (DECT/CT1CT2), remote controls, security systems, wireless PDAs, smart phones, etc. LCWC is used in broadband applications such as CATV filters, tuners, cable modems and XDSL tuners, and set top boxes. LCWC is used in IT applications such as USB 2.0 and IEEE 1394. LCWC has a tighter tolerance down to $\pm 2\%$, and an operating temperature of -40°C to $+125^{\circ}\text{C}$.

LCWC Series Datasheet can be found in the Chip Inductors Catalog



[View LCWC Series Datasheet](#)

RF Inductors

LCCI Series – Multi-Layer Ceramic Chip Inductors

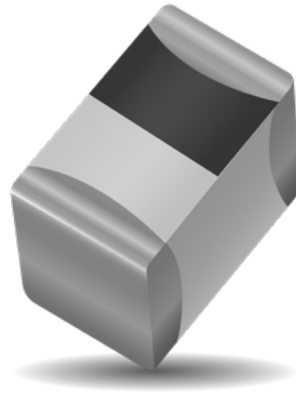

GENERAL DESCRIPTION

Suitable for high-frequency applications, KYOCERA AVX LCCI series has a tight tolerance in physical dimensions, a tight inductance tolerance, excellent Q and a guaranteed SRF range. The LCCI series features a ceramic integrated structure, resulting in high product quality and outstanding reliability. All parts are lead-free and comply with RoHS standards. The LCCI series has an operating temperature of -40°C to +85°C. Also, the surface mounting applicability supports reflow soldering conditions without sacrificing any frequency characteristics.

LCCI Series Datasheet can be found in the Chip Inductors Catalog



[View LCCI Series Datasheet](#)

RF/Microwave Capacitors

RF/Microwave Multilayer Capacitors (MLC)

100A Series Porcelain Superchip® Multilayer Capacitors

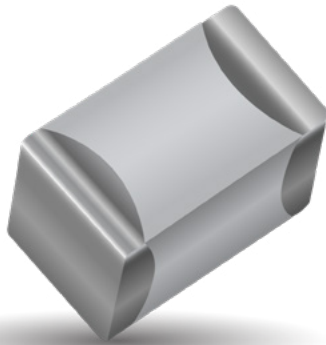

FEATURES

- Case A Size (.055" x .055")
- Lowest ESR/ESL
- High Q
- Low Noise
- Capacitance Range 0.1 pF to 100 pF
- Extended WVDC up to 250 VDC
- Ultra-Stable Performance
- High Self-Resonance
- Established Reliability (QPL)

GENERAL DESCRIPTION

KYOCERA AVX, the industry leader, offers new improved ESR/ESL performance for the 100A Series RF/Microwave Capacitors. This is KYOCERA AVX most versatile high Q, high self resonant multilayer capacitor. High density porcelain construction provides a rugged, hermetic package.

Typical functional applications: Bypass, Coupling, Tuning, Feedback, Impedance Matching and DC Blocking.

Typical circuit applications: Microwave/RF/IF Amplifiers, Mixers, Oscillators, Low Noise Amplifiers, Filter Networks, Timing Circuits and Delay Lines.

PACKAGING OPTIONS



ELECTRICAL SPECIFICATIONS

Temperature Coefficient (TCC)	90 ± 20 PPM/°C
Capacitance Range	0.1 pF to 100 pF
Operating Temperature	-55°C to +125°C*
Quality Factor	Greater than 10,000 @ 1 MHz.
Insulation Resistance (IR)	0.1 pF to 100 pF 10 ⁶ Megohms min. @ 25°C at rated WVDC 10 ⁵ Megohms min. @ 125°C at rated WVDC
Working Voltage (WVDC)	See Capacitance Values table
Dielectric Withstanding Voltage (DWV)	250% of rated WVDC for 5 seconds
Aging Effects	None
Piezoelectric Effects	None
Capacitance Drift	± (0.02% or 0.02 pF), whichever is greater

ENVIRONMENTAL CHARACTERISTICS

Thermal Shock	Mil-STD-202, Method 107, Condition A
Moisture Resistance	Mil-STD-202, Method 106
Low Voltage Humidity	Mil-STD-202, Method 103, condition A, with 1.5 VDC applied while subjected to an environment of 85°C with 85% relative humidity for 240 hours
Life Test	MIL-STD-202, Method 108, for 2000 hours, at 125°C. 200% WVDC applied.
Termination Styles	Available in various surface mount styles. See Mechanical Configurations, page 3
Terminal Strength	Terminations for chips and pellets withstand a pull of 5 lbs. min., 10 lbs. typical, for 5 seconds in direction perpendicular to the termination surface of the capacitor.

RF/Microwave Capacitors

RF/Microwave Multilayer Capacitors (MLC)

100A Series Porcelain Superchip® Multilayer Capacitors



CAPACITANCE VALUES

Cap. Code	Cap. (pF)	Tol.	Rated WVDC		Cap. Code	Cap. (pF)	Tol.	Rated WVDC		Cap. Code	Cap. (pF)	Tol.	Rated WVDC																	
			STD.	EXT.				STD.	EXT.				STD.	EXT.																
0R1	0.1	B	150	EXTENDED VOLTAGE	2R2	2.2	B, C, D	150	EXTENDED VOLTAGE	160	16	F, G, J, K, M	150	VOLTAGE																
0R2	0.2				2R4	2.4				180	18																			
0R3	0.3				2R7	2.7				200	20																			
0R4	0.4				3R0	3.0				220	22																			
0R5	0.5	B, C			250	EXTENDED VOLTAGE				3R3	3.3				B, C, D	250	EXTENDED VOLTAGE	240	24	F, G, J, K, M	250	VOLTAGE								
0R6	0.6									3R6	3.6							270	27											
0R7	0.7									3R9	3.9							300	30											
0R8	0.8									4R3	4.3							330	33											
0R9	0.9	B, C, D								250	EXTENDED VOLTAGE							4R7	4.7				B, C, D	250	EXTENDED VOLTAGE	360	36	F, G, J, K, M	250	VOLTAGE
1R0	1.0																	5R1	5.1							390	39			
1R1	1.1																	5R6	5.6							430	43			
1R2	1.2																	6R2	6.2							470	47			
1R3	1.3	B, C, D	250	EXTENDED VOLTAGE			6R8	6.8	B, C, J, K, M			250	EXTENDED VOLTAGE	510				51	F, G, J, K, M							250	VOLTAGE			
1R4	1.4						7R5	7.5						560				56												
1R5	1.5						8R2	8.2						620				62												
1R6	1.6						9R1	9.1						680				68												
1R7	1.7	B, C, D			250	EXTENDED VOLTAGE	100	10						B, C, J, K, M	250	EXTENDED VOLTAGE	750	75		F, G, J, K, M	250	VOLTAGE								
1R8	1.8						110	11									820	82												
1R9	1.9						120	12									910	91												
2R0	2.0						130	13									101	100												
2R1	2.1	B, C, D					250	EXTENDED VOLTAGE		150	15						B, C, J, K, M	250					EXTENDED VOLTAGE					F, G, J, K, M	250	VOLTAGE

$v_{rms} = 0.707 \times WVDC$

Special values, tolerances, different WVDC and matching available. Please consult factory.

Note: Extended WVDC does not apply to CDR products

HOW TO ORDER



The above part number refers to a 100 A Series (case size A) 10 pF capacitor, J tolerance (±5%), 150 WVDC, with W termination (Tin / Lead, Solder Plated over Nickel Barrier), Laser Marking and Tape and Reel 1000 pc qty packaging.

RF/Microwave Capacitors

RF/Microwave Multilayer Capacitors (MLC)

100A Series Porcelain Superchip® Multilayer Capacitors



MECHANICAL CONFIGURATION

Series & Case Size	Term. Code	MIL-PRF-55681	Case Size & Type	Outline W/T is a Termination Surface	Body Dimensions inches (mm)			Lead and Termination Dimensions and Material		Pkg Type & Qty	Pkg Code
					Length (L)	Width (W)	Thickness (T)	Overlap (Y)	Materials		
100A	W	CDR12BG	A Solder Plate		.055+.015-.010 (1.40+0.38-0.25)	.055 ±.015 (1.40 ±0.38)	.057 (1.45) max.	.010 + .010 - .005 (0.25 + 0.25 - 0.13)	Tin/ Lead, Solder Plated over Nickel Barrier Termination	T&R, 1000 or 500 pcs Vertical T&R, 1000 or 500 pcs Cap Pac, 100 pcs	T1K or T TV1K or TV C100
100A	P	CDR12BG	A Pellet		.055+.025-.010 (1.40+0.64-0.25)	.055 ±.015 (1.40 ±0.38)			Heavy Tin/ Lead Coated, over Nickel Barrier Termination	T&R, 1000 or 500 pcs Vertical T&R, 1000 or 500 pcs Cap Pac, 100 pcs	T1K or T TV1K or TV C100
100A	T	N/A	A Solderable Nickel Barrier		.055+.015-.010 (1.40+0.38-0.25)	.055 ±.015 (1.40 ±0.38)			RoHS Compliant Tin Plated over Nickel Barrier Termination	T&R, 1000 or 500 pcs Vertical T&R, 1000 or 500 pcs Cap Pac, 100 pcs	T1K or T TV1K or TV C100
100A	CA	CDR11BG	A Gold Chip		.055+.015-.010 (1.40+0.38-0.25)	.055 ±.015 (1.40 ±0.38)			RoHS Compliant Gold Plated over Nickel Barrier Termination	T&R, 1000 or 500 pcs Vertical T&R, 1000 or 500 pcs Cap Pac, 100 pcs	T1K or T TV1K or TV C100

NON-MECHANICAL CONFIGURATION

Series & Case Size	Term. Code	MIL-PRF-55681	Case Size & Type	Outline W/T is a Termination Surface	Body Dimensions inches (mm)			Lead and Termination Dimensions and Material		Pkg Type & Qty	Pkg Code
					Length (L)	Width (W)	Thickness (T)	Overlap (Y)	Materials		
100A	WN	Meets Requirements	A Solder Plate		.055+.015-.010 (1.40+0.38-0.25)	.055 ±.015 (1.40 ±0.38)	.057 (1.45) max.	.010 + .010 - .005 (0.25 + 0.25 - 0.13)	Tin/ Lead, Solder Plated over Non-Magnetic Barrier Termination	T&R, 1000 or 500 pcs Vertical T&R, 1000 or 500 pcs Cap Pac, 100 pcs	T1K or T TV1K or TV C100
100A	PN	Meets Requirements	A Pellet		.055+.025-.010 (1.40+0.64-0.25)	.055 ±.015 (1.40 ±0.38)			Heavy Tin/ Lead Coated, over Non-Magnetic Barrier Termination	T&R, 1000 or 500 pcs Vertical T&R, 1000 or 500 pcs Cap Pac, 100 pcs	T1K or T TV1K or TV C100
100A	TN	Meets Requirements	A Solderable Nickel Barrier		.055+.015-.010 (1.40+0.38-0.25)	.055 ±.015 (1.40 ±0.38)			RoHS Compliant Tin Plated over Non-Magnetic Barrier Termination	T&R, 1000 or 500 pcs Vertical T&R, 1000 or 500 pcs Cap Pac, 100 pcs	T1K or T TV1K or TV C100

RF/Microwave Capacitors

RF/Microwave Multilayer Capacitors (MLC)

100A Series Porcelain Superchip® Multilayer Capacitors



SUGGESTED MOUNTING PAD DIMENSIONS

Horizontal Electrode Orientation

Vertical Electrode Orientation

Case A					
Mount Type	Pad Size	A Min.	B Min.	C Min.	D Min.
Vertical Mount	Normal	.070	.050	.030	.130
	High Density	.050	.030	.030	.090
Horizontal Mount	Normal	.080	.050	.030	.130
	High Density	.060	.030	.030	.090

Dimensions are in inches.

PERFORMANCE DATA

ESR VS. CAPACITANCE
SERIES 100, CASE A



Q VS. CAPACITANCE
SERIES 100, CASE A



SERIES RESONANCE VS. CAPACITANCE
SERIES 100, CASE A

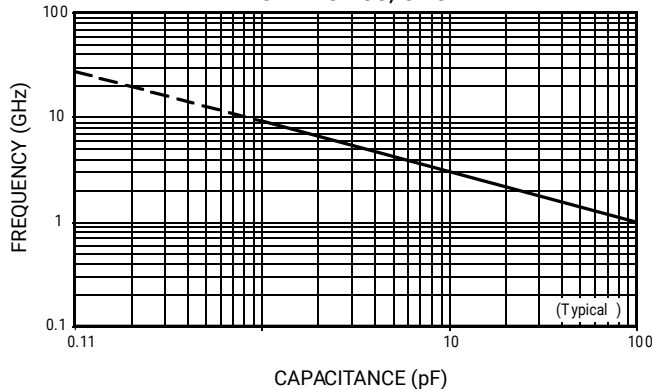

CURRENT RATING VS. CAPACITANCE
SERIES 100, CASE A



RF/Microwave Capacitors
RF/Microwave Multilayer Capacitors (MLC)
100A Series Porcelain Superchip® Multilayer Capacitors



PERFORMANCE DATA

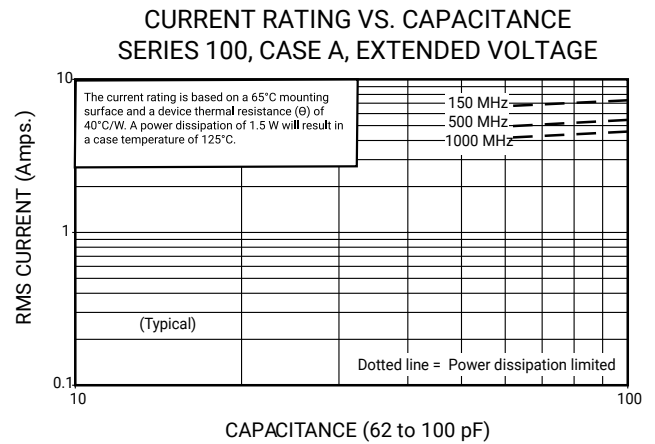
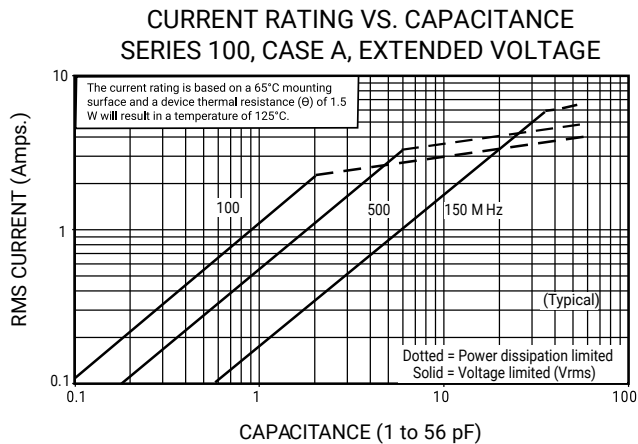
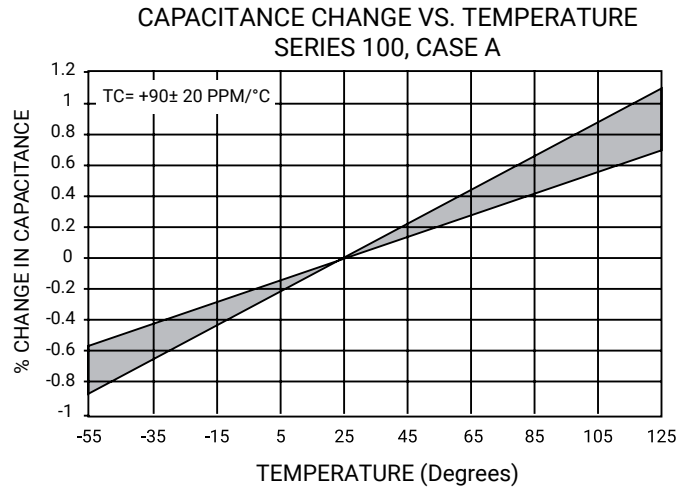

RF/Microwave Capacitors
RF/Microwave Multilayer Capacitors (MLC)
100A Series Porcelain Superchip® Multilayer Capacitors



SAMPLE KITS

Kit #	RoHS Compliant	Item Number	Description	Cap. Value Range (pF)	Cap Value (pF)	Tol.	Price
Kit 1	-	DK0001	100A Porcelain Superchip® 16 different values, 15 pcs. min. per value	0.1 to 2.0	0.1, 0.2, 0.3, 0.4, 0.5, 0.6, 0.7, 0.8, 0.9, 1.0, 1.1, 1.2, 1.5	±0.1	\$160.00
Kit 1T		DK0001T			1.6, 1.8, 2.0	±0.25	
Kit 2	-	DK0002	100A Porcelain Superchip® 16 different values, 15 pc. min. per value	1.0 to 10	1.0, 1.2, 1.5, 1.8, 2.0, 2.2, 2.4, 2.7, 3.0, 3.3	±0.1	\$160.00
Kit 2T		DK0002T			3.9, 4.7, 5.6, 6.8, 8.2	±0.25	
Kit 3	-	DK0003	100A Porcelain Superchip® 16 different values, 15 pc. min. per value	10 to 100	10, 12, 15, 18, 20, 22, 24, 27, 30, 33, 39, 47, 56, 68, 82, 100.....	± 5%	\$160.00
Kit 3T		DK0003T					

RF/Microwave Capacitors

RF/Microwave Multilayer Capacitors (MLC)

100B Series Porcelain Superchip® Multilayer Capacitors

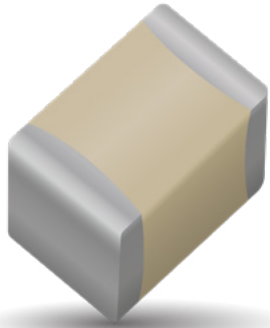

FEATURES

- Case B Size (.110" x .110")
- Capacitance Range 0.1pF to 1000pF
- Extended WVDC up to 1500 VDC
- Low ESR/ESL
- High Q
- Low Noise
- Ultra-Stable Performance
- High Self-Resonance
- Established Reliability (QPL)

GENERAL DESCRIPTION

KYOCERA AVX, the industry leader, offers new improved ESR/ESL performance for the 100 B Series RF/Microwave Capacitors. This Series is now available with extended operating temperatures up to 175°C. High Density porcelain construction provides a rugged, hermetic package.

FUNCTIONAL APPLICATIONS

- Bypass
- Coupling
- Tuning
- Impedance Matching
- DC Blocking

CIRCUIT APPLICATIONS

- UHF/Microwave RF Power Amplifiers
- Oscillators
- Low Noise Amplifiers
- Filter Networks
- Timing Circuits

ENVIRONMENTAL CHARACTERISTICS

Thermal Shock	Mil-STD-202, Method 107, Condition A
Moisture Resistance	Mil-STD-202, Method 106
Low Voltage Humidity	Mil-STD-202, Method 103, condition A, with 1.5 VDC applied while subjected to an environment of 85°C with 85% relative humidity for 240 hours
Life Test	MIL-STD-202, Method 108, for 2000 hours, at 125°C. Voltage applied. 200% of WVDC for capacitors rated at 500 volts DC or less. 120% of WVDC for capacitors rated at 1250 volts DC or less. 100% of WVDC for capacitors rated above 1250 volts DC
Termination Styles	Available in various surface mount and leaded styles. See Mechanical Configurations
Terminal Strength	Terminations for chips and pellets withstand a pull of 5 lbs. min., 15 lbs. typical, for 5 seconds in direction perpendicular to the termination surface of the capacitor.

PACKAGING OPTIONS



Tape & Reel



Vertical Orientation Tape & Reel



Cap Pac® (100 pcs)



ELECTRICAL SPECIFICATIONS

Temperature Coefficient (TCC)	+90 ±20 PPM/°C (-55°C to +125°C) +90 ±30 PPM/°C (+125°C to +175°C)
Capacitance Range	0.1pF to 1000pF
Operating Temperature	-55°C to +125°C*
Quality Factor	greater than 10,000 at 1 MHz
Insulation Resistance (IR)	0.1 pF to 470 pF: 10 ⁶ Megohms min. @ +25°C at rated WVDC. 10 ⁵ Megohms min. @ +125°C at rated WVDC. 510 pF to 1000 pF: 10 ⁵ Megohms min. @ +25°C at rated WVDC. 10 ⁴ Megohms min. @ +125°C at rated WVDC.
Working Voltage (WVDC)	See Capacitance Values table
Dielectric Withstanding Voltage (DWV)	250% of WVDC for capacitors rated at 500 volts DC or less for 5 seconds. 150% of WVDC for capacitors rated at 1250 volts DC or less for 5 seconds. 120% of WVDC for capacitors rated above 1250 Volts DC for 5 seconds
Aging Effects	None
Piezoelectric Effects	None
Capacitance Drift	± (0.02% or 0.02 pF), whichever is greater
Retrace	Less than ±(0.02% or 0.02 pF), whichever is greater.

RF/Microwave Capacitors

RF/Microwave Multilayer Capacitors (MLC)

100B Series Porcelain Superchip® Multilayer Capacitors



CAPACITANCE VALUES

Cap. Code	Cap. (pF)	Tol.	Rated WVDC		Cap. Code	Cap. (pF)	Tol.	Rated WVDC		Cap. Code	Cap. (pF)	Tol.	Rated WVDC		CAP. CODE	CAP. (pF)	TOL.	RATED WVDC	
			STD.	EXT.				STD.	EXT.				STD.	EXT.				STD.	EXT.
0R1	0.1	B	500	1500	2R4	2.4	B, C, D	500	1500	200	20	F, G, J, K, M	500	1500	151	150	F, G, J, K, M	300	EXT.
0R2	0.2				2R7	2.7				220	22				161	160			1000
0R3	0.3	3R0			3.0	240				24	181				180				
0R4	0.4	3R3			3.3	270				27	201				200				
0R5	0.5	3R6			3.6	300				30	221				220				
0R6	0.6	3R9			3.9	330				33	241				240	EXT.			
0R7	0.7	4R3			4.3	360				36	271				270				
0R8	0.8	4R7			4.7	390				39	301				300				
0R9	0.9	5R1			5.1	430				43	331				330	200		600	
1R0	1.0	5R6			5.6	470				47	361				360			VOLT.	
1R1	1.1	6R2	6.2	510	51	391	390												
1R2	1.2	6R8	6.8	560	56	431	430	EXT.											
1R3	1.3	7R5	7.5	620	62	471	470												
1R4	1.4	8R2	8.2	680	68	511	510	100	EXT.										
1R5	1.5	9R1	9.1	750	75	561	560												
1R6	1.6	100	10	820	82	621	620	300											
1R7	1.7	110	11	910	91	681	680												
1R8	1.8	120	12	101	100	751	750												
1R9	1.9	130	13	111	110	821	820	50	300										
2R0	2.0	150	15	121	120	911	910												
2R1	2.1	160	16	131	130	102	1000	50	VOLT										
2R2	2.2	180	18																

VRMS = 0.707 X WVDC

• SPECIAL VALUES, TOLERANCES, DIFFERENT WVDC AND MATCHING AVAILABLE. • ENCAPSULATION OPTION AVAILABLE. PLEASE CONSULT FACTORY. NOTE: EXTENDED WVDC DOES NOT APPLY TO CDR PRODUCTS.

HOW TO ORDER

Series 100 **Case Size** B **Capacitance** 910 **Termination Style Code** J **Voltage Rating** W **Rated WVDC** 500 **Termination Style Code** X **Packaging** T

See mechanical dimensions below

EIA Capacitance Code in pF.
First two digits = significant figures or "R" for decimal place.
Third digit = number of zeros or after "R" significant figures

Capacitance Tolerance Code

Code	B	C	D	F	G	J	K	M
Tol.	±1 pF	±25 pF	±5 pF	±1%	±2%	±5%	±10%	±20%

Packaging
T = Tape and Reel, 500 pc qty
TV = Vertical Tape and Reel, 500 pc qty
Please see last column of mechanical configuration table for other options.

Laser Marking (Optional)

Voltage Rating

Termination Style Code
Please see 2nd Column Mechanical Configuration Table

The above part number refers to a 100 B Series (case size B) 91 pF capacitor, J tolerance (±5%), 500 WVDC, with W termination (Tin /Lead, Solder Plated over Nickel Barrier), laser marking and Tape and Reel packaging.

RF/Microwave Capacitors

RF/Microwave Multilayer Capacitors (MLC)

100B Series Porcelain Superchip® Multilayer Capacitors



MECHANICAL CONFIGURATION

Series & Case Size	Term. Code	MIL-PRF-55681	Case Size & Type	Outline W/T is a Termination Surface	Body Dimensions inches (mm)			Lead and Termination Dimensions and Material			Pkg Type	Pkg Code			
					Length (L)	Width (W)	Thickness (T)	Overlap (Y)	Materials						
100B	W	CDR14BG	Solder Plate		.110+ .020 - .01 (2.79 + 0.51-0.25)	.110 ±.015 (2.79 ±.038)	.102 (2.59) max.	.015 (0.38) ±.010 (0.25)	Tin / Lead, Solder Plated over Nickel Barrier Termination		T&R, 1000 or 500 pcs Vertical T&R, 1000 or 500 pcs Cap Pac, 100 pcs	T1K or T TV1K or TV C100			
100B	P	CDR14BG	Pellet		.110+ .035 - .01 (2.79 + 0.89-0.25)	.110 ±.015 (2.79 ±.038)			Heavy Tin/Lead Coated, over Nickel Barrier Termination		T&R, 1000 or 500 pcs Vertical T&R, 1000 or 500 pcs Cap Pac, 100 pcs	T1K or T TV1K or TV C100			
100B	T	N/A	Solderable Nickel		.110+ .035 - .01 (2.79 + 0.51-0.25)	.110 ±.015 (2.79 ±.038)			RoHS Compliant Tin Plated over Nickel Barrier Termination		T&R, 1000 or 500 pcs Vertical T&R, 1000 or 500 pcs Cap Pac, 100 pcs	T1K or T TV1K or TV C100			
100B	CA	CDR13BG	Gold Chip		.110+.020 - .010 (2.79 + 0.51-0.25)	.110 ±.015 (2.79 ±.038)			RoHS Compliant Gold Plated over Nickel Barrier Termination		T&R, 1000 or 500 pcs Vertical T&R, 1000 or 500 pcs Cap Pac, 100 pcs	T1K or T TV1K or TV C100			
100B	MS	CDR21BG	Microstrip		.135 ±.015 (3.43 ±.038)	.110 ±.015 (2.79 ±.038)	.120 (3.05) max.	N/A	Length (L _L)	Width (W _L)	Thickness (T _L)	Cap Pac, 20 pcs	C20		
100B	AR	CDR22BG	Axial Ribbon				.250 (6.35) min.		.093±.005 (2.36 ±0.13)	.004 ± .001 (.102±.025)	Box, 20 or 100 pcs		B20 or B100		
100B	RR	CDR24BG	Radial Ribbon				.145 ±.020 (3.68 ±0.51)		.102 (2.59) max.	.500 (12.7)	#26 AWG, .016 (.406) dia. nominal		Box, 20 or 100 pcs		B20 or B100
100B	RW	CDR23BG	Radial Wire								Box, 20 or 100 pcs		B20 or B100		
100B	AW	CDR25BG	Axial Wire		Box, 20 or 100 pcs		B20 or B100								

Additional lead styles available: Narrow Microstrip (NM), Narrow Axial Ribbon (NA) and Vertical Narrow Microstrip (H). Other lead lengths are available; consult factory. All leads are high purity silver attached with high temperature solder and are RoHS compliant.

RF/Microwave Capacitors

RF/Microwave Multilayer Capacitors (MLC)

100B Series Porcelain Superchip® Multilayer Capacitors



NON-MAGNETIC MECHANICAL CONFIGURATION

Series & Case Size	Term. Code	MIL-PRF-55681	Case Size & Type	Outline W/T is a Termination Surface	Body Dimensions inches (mm)			Lead and Termination Dimensions and Material			Pkg Type	Pkg Code	
					Length (L)	Width (W)	Thickness (T)	Overlap (Y)	Materials				
100B	WN	Meets Requirements	Non-Mag		.110+ .020 - .01 (2.79 + 0.51-0.25)	.110 ±.015 (2.79 ±0.38)	.102 (2.59) max.	.015 (0.38) ±.010 (0.25)	Tin / Lead, Solder Plated over Nickel Barrier Termination		T&R, 1000 or 500 pcs Vertical T&R, 1000 or 500 pcs Cap Pac, 100 pcs	T1K or T TV1K or TV C100	
100B	PN	Meets Requirements	Solderable Nickel		.110+ .035 - .01 (2.79 + 0.51-0.25)	.110 ±.015 (2.79 ±0.38)			Heavy Tin / Lead, Coated over Non-Magnetic Barrier Termination		T&R, 1000 or 500 pcs Vertical T&R, 1000 or 500 pcs Cap Pac, 100 pcs	T1K or T TV1K or TV C100	
100B	TN	Meets Requirements	Non-Mag Solderable Barrier		.110+.020 - .010 (2.79 + 0.51-0.25)	.110 ±.015 (2.79 ±0.38)			RoHS Compliant Tin Plated over Non-Magnetic Barrier Termination		T&R, 1000 or 500 pcs Vertical T&R, 1000 or 500 pcs Cap Pac, 100 pcs	T1K or T TV1K or TV C100	
100B	MN	Meets Requirements	Microstrip		.135 ±.015 (3.43 ±0.38)	.110 ±.015 (2.79 ±0.38)	.120 (3.05) max.	N/A	Length (L _L)	Width (W _L)	Thickness (T _L)	Cap Pac, 20 pcs	C20
100B	AN	Meets Requirements	Axial Ribbon						.250 (6.35) (6.35) min.	.093±.005 (2.36 ±0.13)	.004 ± .001 (.102±.025)	Box, 20 or 100 pcs	B20 or B100
100B	FN	Meets Requirements	Radial Ribbon						.145 ±.020 (3.68 ±0.51)	.102 (2.59) max.	N/A	.500 (12.7)	#26 AWG., .016 (.406) dia. nominal
100B	RN	Meets Requirements	Radial Wire		Box, 20 or 100 pcs	B20 or B100							
100B	BN	Meets Requirements	Axial Wire								Box, 20 or 100 pcs	B20 or B100	

Additional lead styles available: Narrow Microstrip (NM), Narrow Axial Ribbon (NA) and Vertical Narrow Microstrip (H). Other lead lengths are available; consult factory. All leads are high purity silver attached with high temperature solder and are **RoHS** compliant.

RF/Microwave Capacitors

RF/Microwave Multilayer Capacitors (MLC)

100B Series Porcelain Superchip® Multilayer Capacitors



SUGGESTED MOUNTING PAD DIMENSIONS

Horizontal
Electrode Orientation

Vertical
Electrode Orientation

Case B Vertical Mount

Cap Value	Pad Size	A Min.	B Min.	C Min.	D Min.
0.1 pF	Normal	.065	.050	.075	.175
	High Density	.045	.030	.075	.135
0.2 pF	Normal	.090	.050	.075	.175
	High Density	.070	.030	.075	.135
0.3 to 510 pF	Normal	.110	.050	.075	.175
	High Density	.090	.030	.075	.135
> 510 pF	Normal	.120	.050	.075	.175
	High Density	.100	.030	.075	.135

Horizontal Mount

All Values	Normal	.130	.050	.075	.175
	High Density	.110	.030	.075	.135

PERFORMANCE DATA

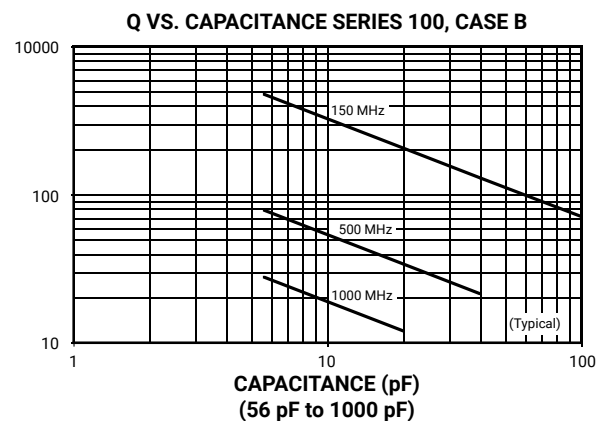
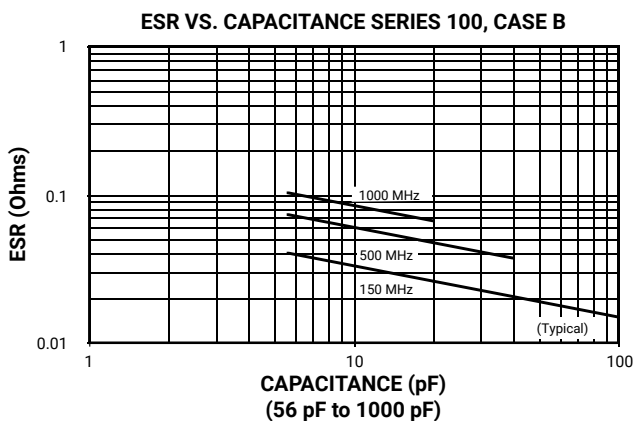
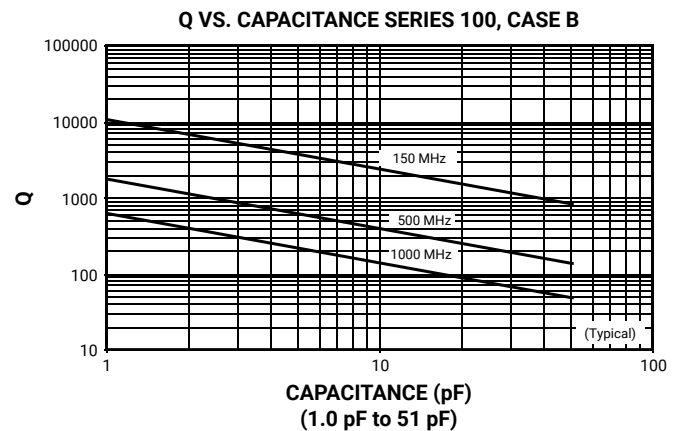
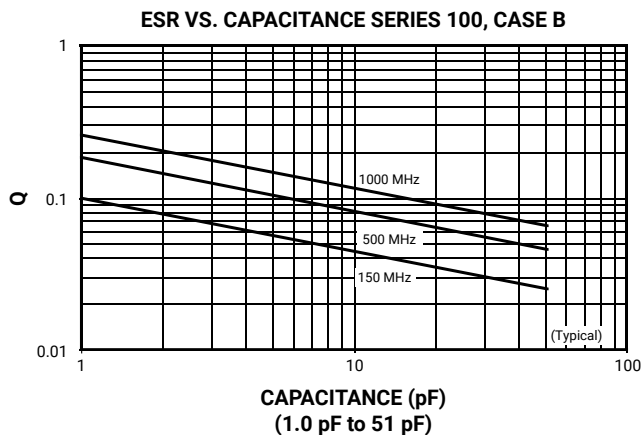

RF/Microwave Capacitors

RF/Microwave Multilayer Capacitors (MLC)

100B Series Porcelain Superchip® Multilayer Capacitors



PERFORMANCE DATA

SERIES RESONANCE VS. CAPACITANCE
SERIES 100, CASE B

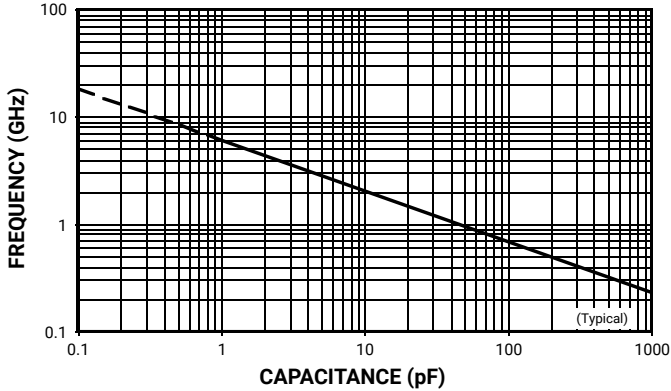

CAPACITANCE CHANGE VS. TEMPERATURE
SERIES 100, CASE B

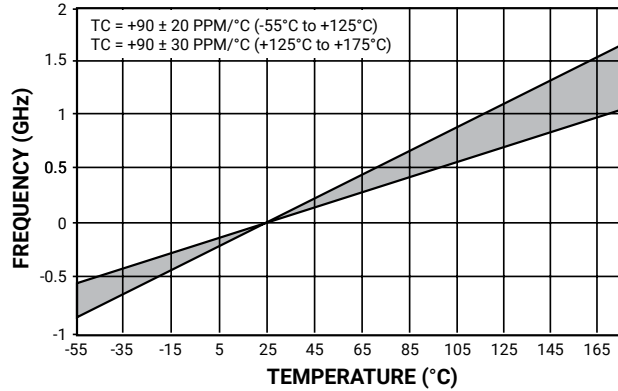

CURRENT RATING VS. CAPACITANCE
SERIES 100, CASE B

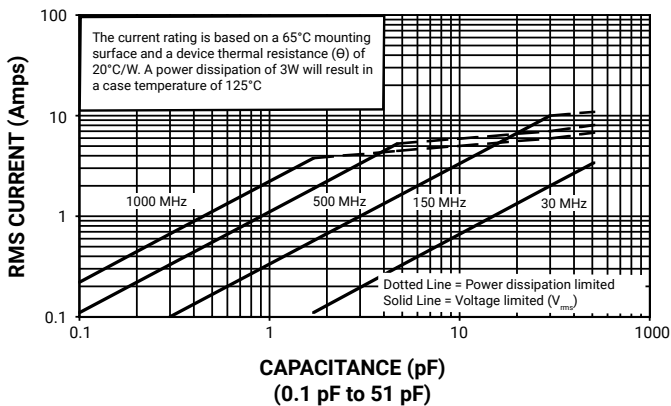

CURRENT RATING VS. CAPACITANCE
SERIES 100, CASE B

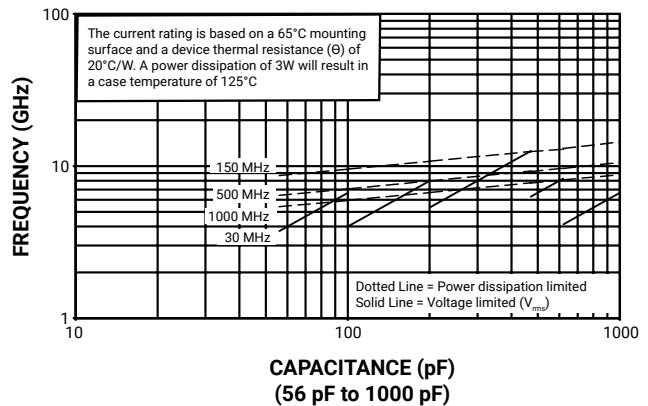

RF/Microwave Capacitors
RF/Microwave Multilayer Capacitors (MLC)
100B Series Porcelain Superchip® Multilayer Capacitors



PERFORMANCE DATA

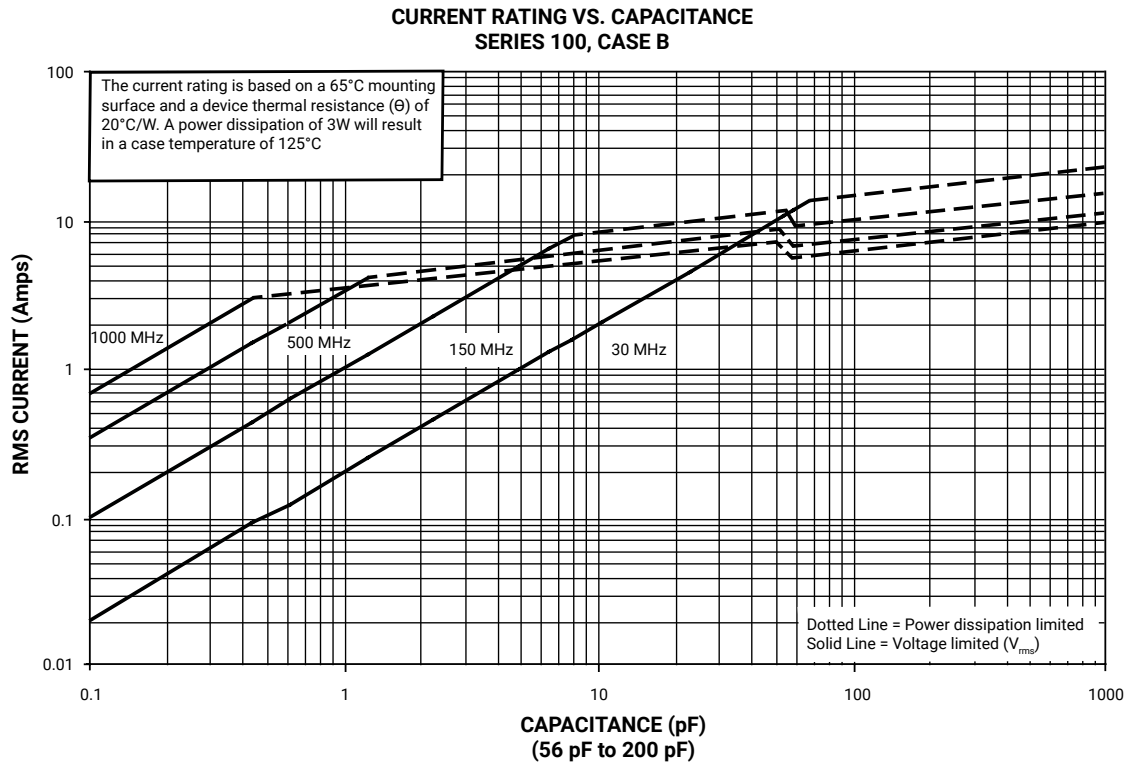

DESIGN KITS

Kit #	RoHS Compliant	Item #	Description	Cap. Value Range (pF)	Cap. Value (pF)	Tol. (pF)	Price
Kit 9		DK0009	100B Porcelain Superchip®, 16 different values, 15 pcs. min. per value	0.1 to 2.0	10, 12, 15, 18, 20, 22, 24, 27, 30, 33, 39, 47, 56, 68, 82, 100	±5%	\$180.00
Kit 9T		DK0009T					
Kit 10		DK0010	100B Porcelain Superchip®, 16 different values, 15 pcs. min. per value	10 to 27	100, 120, 150, 180, 200, 220, 240, 270, 300, 330, 390, 470	±5%	\$180.00
Kit 10T		DK0010T					

For Online Kit Orders, Catalog & Application Notes, Visit: www.avx.com

RF/Microwave Capacitors

RF/Microwave Multilayer Capacitors (MLC)

100C Series Porcelain Superchip® Multilayer Capacitors

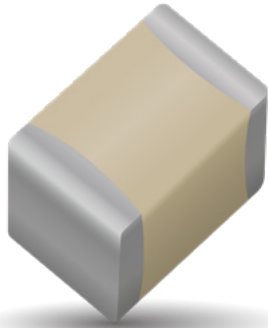

GENERAL DESCRIPTION

KYOCERA AVX, the industry leader, offers new improved ESR/ESL performance for the 100C Series RF Capacitors. This high Q multilayer capacitor is ultra-stable under high RF current and voltage applications. High density Porcelain construction provides a rugged, hermetic package.

KYOCERA AVX offers an encapsulation option for applications requiring extended protection against arc-over and corona.

FUNCTIONAL APPLICATIONS

- Bypass
- Impedance Matching
- Coupling
- DC Blocking
- Tuning

CIRCUIT APPLICATIONS

- VHF/UHF RF Power Amplifiers
- Plasma Chambers
- Antenna Tuning
- Medical (MRI coils)

ENVIRONMENTAL CHARACTERISTICS

Thermal Shock	MIL-STD-202, Method 107, Condition A
Moisture Resistance	MIL-STD-202, Method 106
Low Voltage Humidity	MIL-STD-202, Method 103, Condition A, with 1.5 Volts DC applied while subjected to an environment of 85°C with 85% relative humidity for 240 hours min.
Life Test	MIL-STD-202, Method 108, for 2000 hours, at 125°C. Voltage applied. 200% of WVDC for capacitors rated at 500 volts DC or less. 120% of WVDC for capacitors rated at 1250 volts DC or less. 100% of WVDC for capacitors rated above 1250 volts DC.
Termination Styles	Available in various surface mount and leaded styles. See Mechanical Configurations
Terminal Strength	Terminations for chips and pellets withstand a pull of 10 lbs. min., 20 lbs. typical, for 5 seconds in direction perpendicular to the termination surface of the capacitor. Test per MIL-STD-202, method 211.

FEATURES

- Case C Size (.250" x .250")
- Capacitance Range 1pF to 2700pF
- Extended WVDC up to 3600 VDC
- Low ESR/ESL
- High Q
- Low Noise
- Ultra-Stable Performance
- High Self-Resonance
- Established Reliability (QPL)

PACKAGING OPTIONS



Tape & Reel



Tray
(180 pcs)



ELECTRICAL SPECIFICATIONS

Temperature Coefficient (TCC)	+90 ±30 PPM/°C (-55°C to +125°C)
Insulation Resistance (IR)	1 pF to 2700 pF: 10 ⁵ Megohms min. @ +25°C at rated WVDC. 10 ⁴ Megohms min. @ +125°C at rated WVDC. Max. test voltage is 500 VDC.
Working Voltage (WVDC)	See Capacitance Values Table
Dielectric Withstanding Voltage (DWV)	250% of WVDC for capacitors rated at 500 volts DC or less for 5 seconds. 150% of WVDC for capacitors rated at 1250 volts DC or less for 5 seconds. 120% of WVDC for capacitors rated above 1250 Volts DC for 5 seconds
Retrace	Less than ±(0.02% or 0.02 pF), whichever is greater.
Aging Effects	None
Piezoelectric Effects	None
Capacitance Drift	±(0.02% or 0.02 pF), whichever is greater.
Operating Temperature Range	From -55°C to +125°C (No derating of working voltage)

RF/Microwave Capacitors

RF/Microwave Multilayer Capacitors (MLC)

100C Series Porcelain Superchip® Multilayer Capacitors



CAP. CODE	CAP. (pF)	TOL.	RATED WVDC		CAP. CODE	CAP. (pF)	TOL.	RATED WVDC		CAP. CODE	CAP. (pF)	TOL.	RATED WVDC		CAP. CODE	CAP. (pF)	TOL.	RATED WVDC	
			STD.	EXT.				STD.	EXT.				STD.	EXT.				STD.	EXT.
1R0	1.0	B, C, D	2500	3600	5R1	5.1	B, C, D	2500	3600	390	39	F, G, J, K, M	2500	3600	301	300	F, G, J, K, M	1500	2000
1R1	1.1				5R6	5.6				430	43				331	330			
1R2	1.2				6R2	6.2				470	47				361	360			
1R3	1.3				6R8	6.8				510	51				391	390			
1R4	1.4				7R5	7.5				560	56				431	430			
1R5	1.5				8R2	8.2				620	62				471	470			
1R6	1.6				9R1	9.1				680	68				511	510			
1R7	1.7				100	10				750	75				561	560			
1R8	1.8				110	11				820	82				621	620			
1R9	1.9				120	12				910	91				681	680			
2R0	2.0	B, C, D	2500	3600	130	13	F, G, J, K, M	2500	3600	101	100	F, G, J, K, M	2500	3000	751	750	F, G, J, K, M	1000	1500
2R1	2.1				150	15				111	110				821	820			
2R2	2.2				160	16				121	120				911	910			
2R4	2.4				180	18				131	130				102	1000			
2R7	2.7				200	20				151	150				112	1100			
3R0	3.0				220	22				161	160				122	1200			
3R3	3.3				240	24				181	180				152	1500			
3R6	3.6				270	27				201	200				182	1800			
3R9	3.9				300	30				221	220				222	2200			
4R3	4.3				330	33				241	240				242	2400			
4R7	4.7	360	36	271	270	272	2700												

VRMS = 0.707 x WVDC

• SPECIAL VALUES, TOLERANCES, HIGHER WVDC AND MATCHING AVAILABLE. • ENCAPSULATION OPTION AVAILABLE. PLEASE CONSULT FACTORY.

HOW TO ORDER

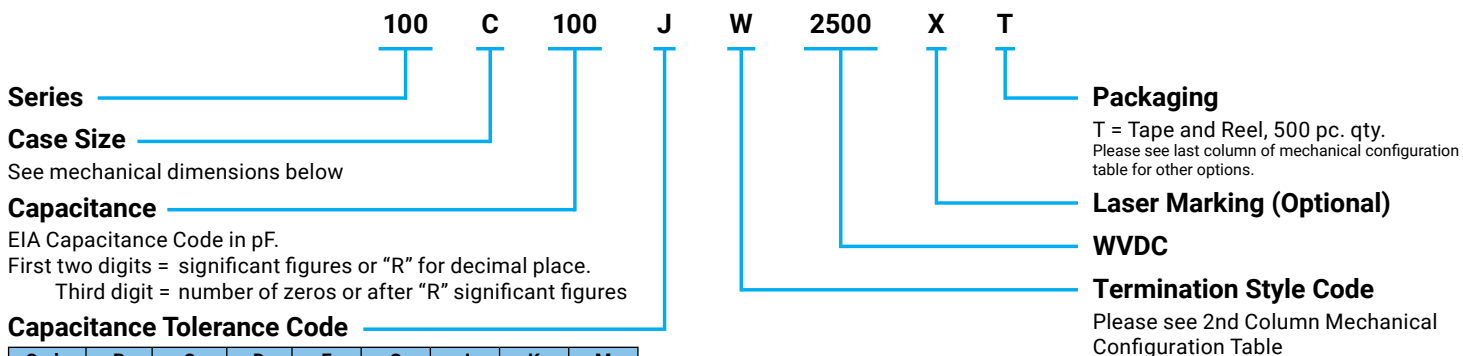

The above part number refers to a 100 C Series (case size C) 10 pF capacitor, J tolerance (±5%), 2500 WVDC, with W termination (Tin/Lead, Solder Plated over Nickel Barrier), laser marking and 500 pc T&R packaging.

RF/Microwave Capacitors

RF/Microwave Multilayer Capacitors (MLC)

100C Series Porcelain Superchip® Multilayer Capacitors



MECHANICAL CONFIGURATIONS

ATC SERIES & CASE SIZE	ATC TERM. CODE	CASE SIZE & TYPE	OUTLINES W/T IS A TERMINATION SURFACE	BODY DIMENSIONS INCHES (MM)			LEAD AND TERMINATION DIMENSIONS AND MATERIALS		Pkg. Type	Pkg Code	
				LENGTH (L)	WIDTH (W)	THICKNESS (T)	OVERLAP (Y)	MATERIALS			
100C	W	Solder Plate		.230+.020 -.010 (5.84+0.51-0.25)	.250 ±0.015 (6.35 ±0.38)	.145(3.68) max. for capacitance values ≤680pF	.040 (1.02) max.	Tin/Lead, Solder Plated over Nickel Barrier Termination	T&R, 250 or 500 pcs Tray, 36 or 180 pcs	T250 or T J36 or J180	
100C	P	Pellet		.230+.025 -.010 (5.84+0.64-0.25)				Heavy Tin/Lead Coated, over Nickel Barrier Termination	T&R, 250 or 500 pcs Tray, 36 or 180 pcs	T250 or T J36 or J180	
100C	T	Solderable Nickel Barrier		.230+.020 -.010 (5.84+0.51-0.25)				RoHS Compliant Tin Plated over Nickel Barrier Termination	T&R, 250 or 500 pcs Tray, 36 or 180 pcs	T250 or T J36 or J180	
100C	MS	Microstrip		.245 ±0.025 (6.22 ±0.64)			.165(4.19) max. for capacitance values >680pF	N/A	High Purity Silver Leads $L_L = .500$ (12.7) min. $W_L = .240 \pm .005$ (6.10 ± 0.127) $T_L = .004 \pm .001$ (.102 ± 0.025) Leads are Attached with High Temperature Solder.	Tray, 24 or 60 pcs	J24 or J60
100C	AR	Axial Ribbon							Box, 24 pcs	B24	
100C	AW	Axial Wire							Box, 21 pcs	B21	
100C	VA	Vertical Axial Ribbon		Box, 24 pcs			B24				
100C	RW	Radial Wire		Tray, 16 pcs	J16						

RF/Microwave Capacitors

RF/Microwave Multilayer Capacitors (MLC)

100C Series Porcelain Superchip® Multilayer Capacitors



NON-MAGNETIC MECHANICAL CONFIGURATIONS

ATC SERIES & CASE SIZE	ATC TERM. CODE	CASE SIZE & TYPE	OUTLINES W/T IS A TERMINATION SURFACE	BODY DIMENSIONS INCHES (MM)			LEAD AND TERMINATION DIMENSIONS AND MATERIALS		Pkg. Type	Pkg Code
				LENGTH (L)	WIDTH (W)	THICKNESS (T)	OVERLAP (Y)	MATERIALS		
100C	WN	Non-Mag Solder Plate		.230±.025-.010 (5.84±0.64-0.25)	.250 ±.015 (6.35 ±0.38)	.145(3.68) max. for capacitance values ≤680pF .165(4.19) max. for capacitance values >680pF	.040 (1.02) max.	Tin/Lead, Solder Plated over Non-Magnetic Barrier Termination	T&R, 250 or 500 pcs Tray, 36 or 180 pcs	T250 or T J36 or J180
100C	PN	Non-Mag Pellet		.230±.035-.010 (5.84±0.89-0.25)				Heavy Tin/Lead Coated, over Non-Magnetic Barrier Termination	T&R, 250 or 500 pcs Tray, 36 or 180 pcs	T250 or T J36 or J180
100C	TN	Non-Mag Solderable Nickel Barrier		.230±.025-.010 (5.84±0.64-0.25)				RoHS Compliant Tin Plated over Non-Magnetic Barrier Termination	T&R, 250 or 500 pcs Tray, 36 or 180 pcs	T250 or T J36 or J180
100C	MN	Non-Mag Microstrip		.245 ±.025 (6.22 ±0.64)				High Purity Silver Leads L _L = .500 (12.7) min. W _L = .240 ±.005 (6.10 ±.127) T _L = .004 ±.001 (.102 ±.025) Leads are Attached with High Temperature Solder.	Tray, 24 or 60 pcs	J24 or J60

SUGGESTED MOUNTING PAD DIMENSIONS

Horizontal Electrode Orientation

Vertical Electrode Orientation

Case C Vertical Mount

Cap Value	Pad Size	A Min.	B Min.	C Min.	D Min.
< 680 pF	Normal	.150	.050	.200	.300
	High Density	.130	.030	.200	.260
> 680 pF	Normal	.185	.050	.200	.300
	High Density	.165	.030	.200	.260

Horizontal Mount

All Values	Pad Size	A Min.	B Min.	C Min.	D Min.
All Values	Normal	.280	.050	.200	.300
	High Density	.260	.030	.200	.260

RF/Microwave Capacitors

RF/Microwave Multilayer Capacitors (MLC)

100C Series Porcelain Superchip® Multilayer Capacitors



PERFORMANCE DATA

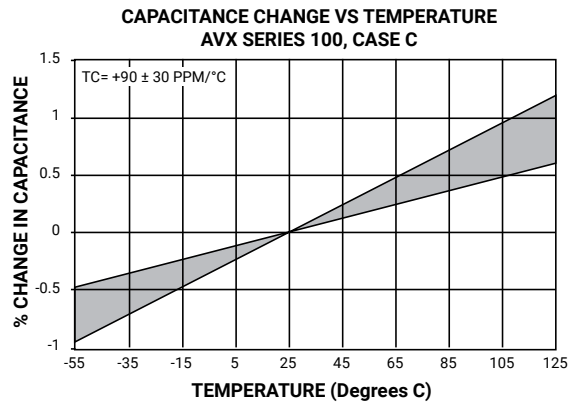
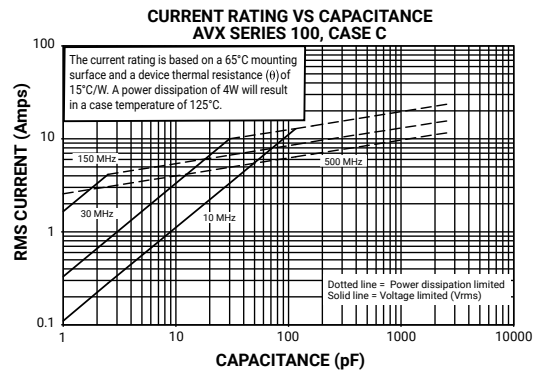
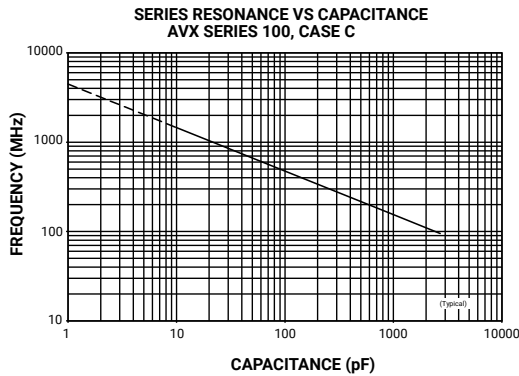
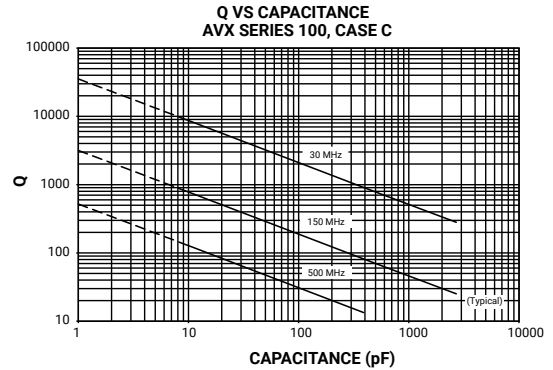
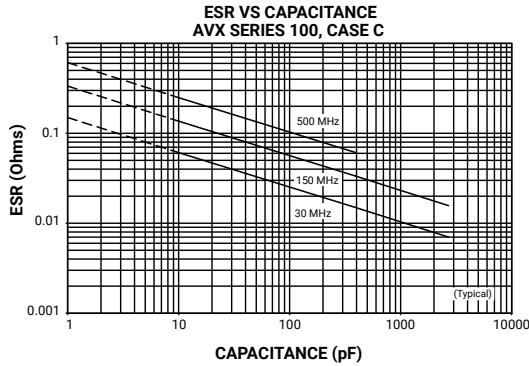

RF/Microwave Capacitors

RF/Microwave Multilayer Capacitors (MLC)

100E Series Porcelain High RF Power Multilayer Capacitors

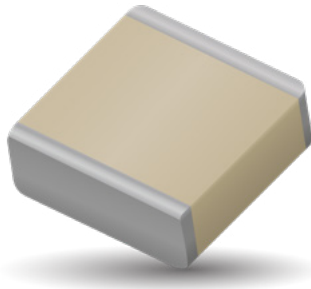

GENERAL DESCRIPTION

KYOCERA AVX, the industry leader, offers new improved ESR/ESL performance for the 100 E Series RF Capacitors. This high Q multilayer capacitor is ultra-stable under high RF current and voltage applications. High density porcelain construction provides a rugged, hermetic package. KYOCERA AVX offers an encapsulation option for applications requiring extended protection against arc-over and corona.

FUNCTIONAL APPLICATIONS

- Bypass
- Impedance Matching
- Coupling
- DC Blocking
- Tuning

CIRCUIT APPLICATIONS

- HF/RF Power Amplifiers
- Plasma Chambers
- Transmitters
- Medical (MRI coils)
- Antenna Tuning

ENVIRONMENTAL CHARACTERISTICS

Thermal Shock	Mil-STD-202, Method 107, Condition A
Moisture Resistance	Mil-STD-202, Method 106
Low Voltage Humidity	Mil-STD-202, Method 103, condition A, with 1.5 VDC applied while subjected to an environment of 85°C with 85% relative humidity for 240 hours
Life Test	MIL-STD-202, Method 108, for 2000 hours, at 125°C. Voltage applied. 200% of WVDC for capacitors rated at 500 volts DC or less. 120% of WVDC for capacitors rated at 1250 volts DC or less. 100% of WVDC for capacitors rated above 1250 volts DC
Termination Styles	Available in various surface mount and leaded styles. See Mechanical Configurations
Terminal Strength	Terminations for chips and pellets withstand a pull of 10 lbs. min., 25 lbs. typical, for 5 seconds in direction perpendicular to the termination surface of the capacitor.

FEATURES

- Case E Size (.380" x .380")
- Capacitance Range 1pF to 5100pF
- Extended WVDC up to 7200 VDC
- Low ESR/ESL
- High Q
- High RF Power
- Ultra-Stable Performance
- High RF Current/Voltage
- Available with Encapsulation Option*

* For leaded styles only

PACKAGING OPTIONS



Tape & Reel



Tray
(96 pcs)



ELECTRICAL SPECIFICATIONS

Temperature Coefficient (TCC)	90 ± 30 PPM/°C
Capacitance Range	1 pF to 5100 pF
Operating Temperature	-55°C to +125°C*
Quality Factor	Greater than 10,000 (1 pF to 1000 pF) @ 1 MHz. Greater than 10,000 (1100 pF to 5100 pF) @ 1 KHz.
Insulation Resistance (IR)	1 pF to 5100 pF 10 ⁵ Megohms min. @ 25°C at 500 VDC 10 ⁴ Megohms min. @ 125°C at 500 VDC
Working Voltage (WVDC)	See Capacitance Values table
Dielectric Withstanding Voltage (DWV)	250% of WVDC for capacitors rated at 500 volts DC or less for 5 seconds. 150% of WVDC for capacitors rated at 1250 volts DC or less for 5 seconds. 120% of WVDC for capacitors rated above 1250 Volts DC for 5 seconds
Aging Effects	None
Piezoelectric Effects	None
Capacitance Drift	± (0.02% or 0.02 pF), whichever is greater
Retrace	Less than ±(0.02% or 0.02 pF), whichever is greater.

RF/Microwave Capacitors

RF/Microwave Multilayer Capacitors (MLC)

100E Series Porcelain High RF Power Multilayer Capacitors



CAPACITANCE VALUES

Cap. Code	Cap. (pF)	Tol.	Rated WVDC		Cap. Code	Cap. (pF)	Tol.	Rated WVDC		Cap. Code	Cap. (pF)	Tol.	Rated WVDC		CAP. CODE	CAP. (pF)	TOL.	RATED WVDC									
			STD.	EXT.				STD.	EXT.				STD.	EXT.				STD.	EXT.								
1R0	1.0	B, C, D	3600	7200	5R6	5.6	B, C, D	3600	7200	470	47	F, G, J, K, M	3600	TAGE	391	390	F, G, J, K, M	2500	3600								
1R1	1.1				6R2	6.2				510	51				431	430											
1R2	1.2				6R8	6.8				560	56				471	470											
1R3	1.3				7R5	7.5				620	62				511	510											
1R4	1.4				8R2	8.2				680	68				561	560											
1R5	1.5				9R1	9.1				750	75				621	620											
1R6	1.6				EXTENDED VOLTAGE	100				10	820				82	EXTENDED VOLTAGE			910	91	EXTENDED VOLTAGE	821	820				
1R7	1.7																							110	11	911	910
1R8	1.8																							120	12	101	100
1R8	1.9																							130	13	111	110
2R0	2.0	150	15	121			120	EXT.	102			1000															
2R1	2.1	160	16	131			130	5000	112			1100															
2R2	2.2	180	18	151			150	VOLT.	122			1200															
2R3	2.3	200	20	161			160		152			1500															
2R4	2.4	220	22	181			180	N/A	182			1800															
3R0	3.0	240	24	201			200		222			2200															
3R3	3.3	270	27	221	220	272	2700																				
3R6	3.6	300	30	241	240	302	3000																				
3R9	3.9	330	33	271	270	332	3300																				
4R3	4.3	360	36	301	300	392	3900																				
4R7	4.7	390	39	331	330	472	4700																				
5R1	5.1	430	43	361	360	512	5100																				

VRMS = 0.707 X WVDC

• SPECIAL VALUES, TOLERANCES, MATCHING, AND CAPACITOR ASSEMBLIES ARE AVAILABLE. • KYOCERA AVX CUSTOM POWER CAPACITOR ASSEMBLY CATALOG, LISTS ASSEMBLY OPTIONS. • DIFFERENT WORKING VOLTAGES ARE AVAILABLE • ENCAPSULATION OPTION AVAILABLE. PLEASE CONSULT FACTORY.

HOW TO ORDER

100 E 391 K W 3600 X T

Series ———— 100

Case Size ———— E
See mechanical dimensions below

Capacitance ———— 391
EIA Capacitance Code in pF.
First two digits = significant figures or "R" for decimal place.
Third digit = number of zeros or after "R" significant figures

Capacitance Tolerance Code ———— K

Code	B	C	D	F	G	J	K	M
Tol.	±1 pF	±25 pF	±5 pF	±1%	±2%	±5%	±10%	±20%

W ———— Voltage Rating

3600 ———— Voltage Rating

X ———— Laser Marking (Optional)

T ———— Packaging
T = Tape and Reel, 250 pc qty. Please see last Column Mechanical Configuration Table for Box and Tray Options

Termination Style Code
Please see 2nd Column Mechanical Configuration Table

The above part number refers to a 100 E Series (case size E) 390 pF capacitor, K tolerance (±10%), 3600 WVDC, with W termination (Tin / Lead, Solder Plated over Nickel Barrier), laser marking and Tape and Reel packaging.

RF/Microwave Capacitors

RF/Microwave Multilayer Capacitors (MLC)

100E Series Porcelain High RF Power Multilayer Capacitors



MECHANICAL CONFIGURATION

Series & Case Size	Term. Code	Case Size & Type	Outline W/T is a Termination Surface	Body Dimensions inches (mm)			Lead and Termination Dimensions and Material		Pkg Type & Qty	Pkg Code	
				Length (L)	Width (W)	Thickness (T)	Overlap (Y)	Materials			
100E	W	E Solder Plate		.380+.015-.010 (9.65+0.38-0.25)	.380 ±.010 (9.65 ±0.25)	.170 (4.32) max.	.040 (1.02) max.	Tin/Lead, Solder Plated over Nickel Barrier Termination	T&R, 250 pcs Tray, 24 or 96 pcs	T J24 J96	
100E	P	E Pellet		.380+.040-.010 (9.65+1.02-0.25)				Heavy Tin/Lead Coated, over Nickel Barrier Termination	T&R, 250 pcs Tray, 24 or 96 pcs	T J24 J96	
100E	T	E Solderable Nickel		.380+.015-.010 (9.65+0.38-0.25)				RoHS Compliant Tin Plated over Nickel Barrier Termination	T&R, 250 pcs Tray, 24 or 96 pcs	T J24 J96	
100E	MS	E Microstrip		.380+.035-.010 (9.65+0.89-0.25)			N/A	N/A	High Purity Silver Leads L _L = .750 (19.05) min W _L = .350 ±.010 (8.89 ±0.25) T _L = .010 ±.005 (0.25 ±0.13) Leads are Attached with High Temperature Solder.	Tray, 16 or 32 pcs	J16 J32
100E	AR	E Axial Ribbon							Tray, 16 or 32 pcs	J16 J32	
100E	AW	E Non-Mag Axial Wire							Box, 20 pcs	B20	
100E	RW	E Non-Mag Radial Wire							Tray, 16 or 64 pcs	J16 J64	

Custom lead styles and lengths are available; consult factory. All leads are high purity silver attached with high temperature solder and are **RoHS** compliant.

RF/Microwave Capacitors

RF/Microwave Multilayer Capacitors (MLC)

100E Series Porcelain High RF Power Multilayer Capacitors



MECHANICAL CONFIGURATION

Series & Case Size	Term. Code	Case Size & Type	Outline W/T is a Termination Surface	Body Dimensions inches (mm)			Lead and Termination Dimensions and Material		Pkg Type & Qty	Pkg Code	
				Length (L)	Width (W)	Thickness (T)	Overlap (Y)	Materials			
100E	WN	Non-Mag Solder Plate		.380+.015-.010 (9.65+0.38-0.25)	.380 ±.010 (9.65 ±0.25)	.170 (4.32) max.	.040 (1.02) max.	Tin/Lead, Solder Plated over Non-Magnetic Barrier Termination	T&R, 250 pcs Tray, 24 or 96 pcs	T J24 J96	
100E	PN	Non-Mag Pellet		.380+.040-.010 (9.65+1.02-0.25)				Heavy Tin/Lead Coated, over Non-Magnetic Barrier Termination	T&R, 250 pcs Tray, 24 or 96 pcs	T J24 J96	
100E	TN	Non-Mag Solderable Barrier		.380+.015-.010 (9.65+0.38-0.25)				RoHS Compliant Tin Plated over Non-Magnetic Barrier Termination	T&R, 250 pcs Tray, 24 or 96 pcs	T J24 J96	
100E	MN	Non-Mag Microstrip		.380+.035-.010 (9.65+0.89-0.25)			N/A	N/A	High Purity Silver Leads $L_L = .750$ (19.05) min $W_L = .350 \pm .010$ (8.89 ±0.25) $T_L = .010 \pm .005$ (0.25 ±0.13) Leads are Attached with High Temperature Solder.	Tray, 16 or 32 pcs	J16 J32
100E	AN	Non-Mag Axial Ribbon							Tray, 16 or 32 pcs	J16 J32	
100E	BN	Non-Mag Axial Wire							Box, 20 pcs	B20	
100E	RN	Non-Mag Radial Wire							Tray, 16 or 64 pcs	J16 J64	

Custom lead styles and lengths are available; consult factory. All leads are high purity silver attached with high temperature solder and are **RoHS** compliant.

RF/Microwave Capacitors

RF/Microwave Multilayer Capacitors (MLC)

100E Series Porcelain High RF Power Multilayer Capacitors



SUGGESTED MOUNTING PAD DIMENSIONS

Horizontal
Electrode Orientation

Vertical
Electrode Orientation

Mount Type	Case E				
	Pad Size	A Min.	B Min.	C Min.	D Min.
Vertical Mount	Normal	.185	.050	.325	.425
	High Density	.165	.030	.325	.385
Horizontal Mount	Normal	.405	.050	.325	.425
	High Density	.385	.030	.325	.385

Dimensions are in inches.

PERFORMANCE DATA

ESR VS. CAPACITANCE
AVX SERIES 100, CASE E

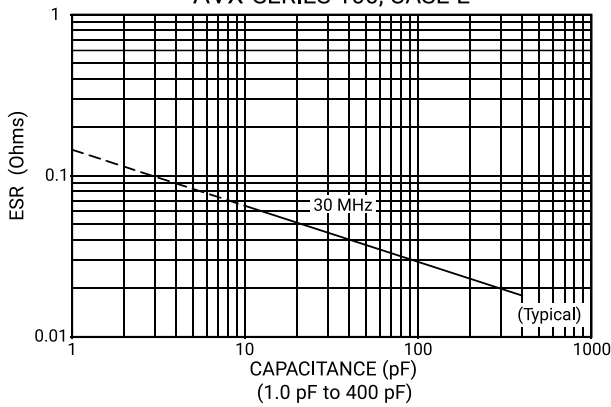

Q VS. CAPACITANCE
AVX SERIES 100, CASE E

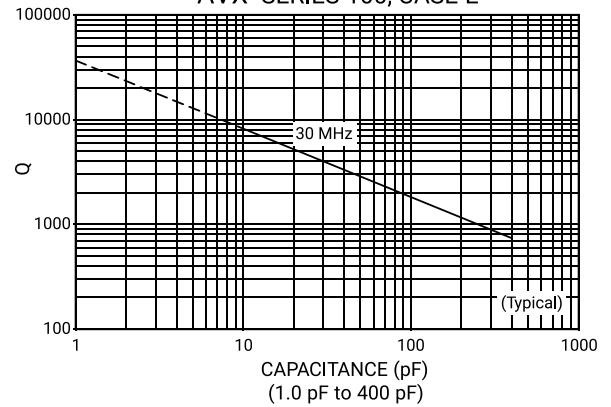

ESR VS. CAPACITANCE
AVX SERIES 100, CASE E

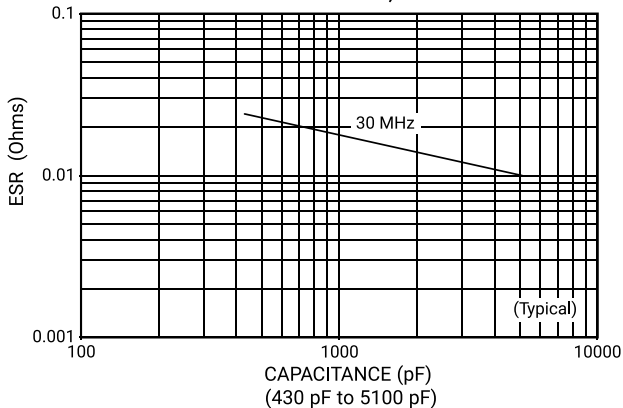

Q VS. CAPACITANCE
AVX SERIES 100, CASE E

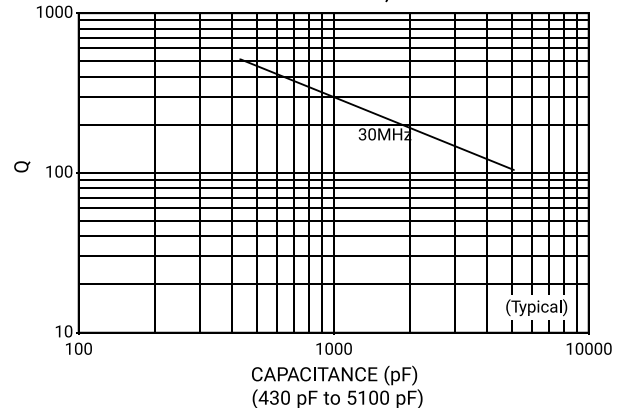

RF/Microwave Capacitors

RF/Microwave Multilayer Capacitors (MLC)

100E Series Porcelain High RF Power Multilayer Capacitors



PERFORMANCE DATA

SERIES RESONANCE VS. CAPACITANCE
AVX SERIES 100, CASE E

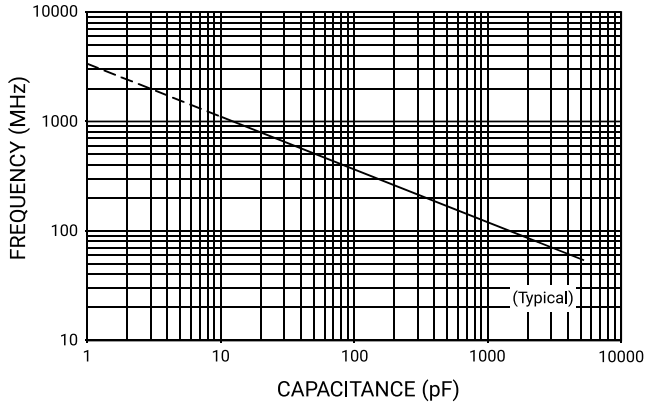

CAPACITANCE CHANGE VS. TEMPERATURE
AVX SERIES 100, CASE E

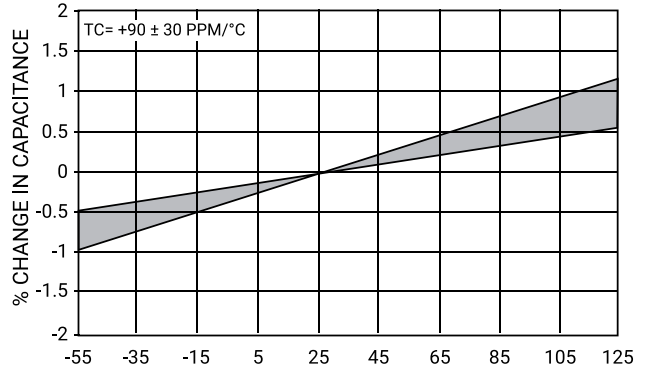

CURRENT RATING VS. CAPACITANCE
AVX SERIES 100, CASE E

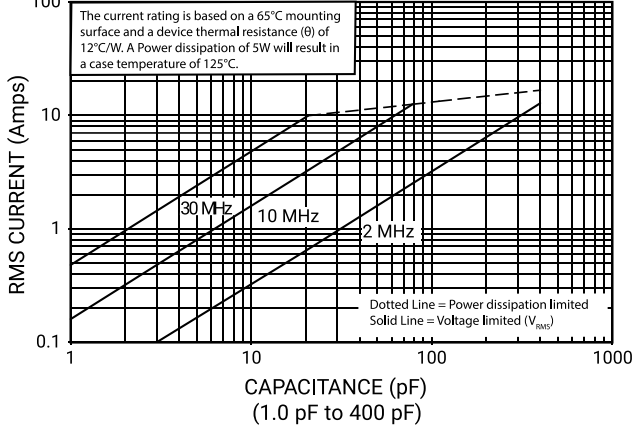

CURRENT RATING VS. CAPACITANCE
AVX Series 100, CASE E

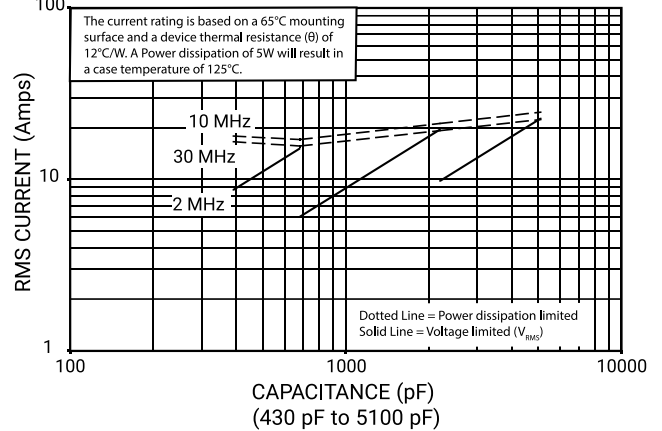

CURRENT RATING VS. CAPACITANCE
AVX SERIES 100, CASE E, EXTENDED VOLTAGE

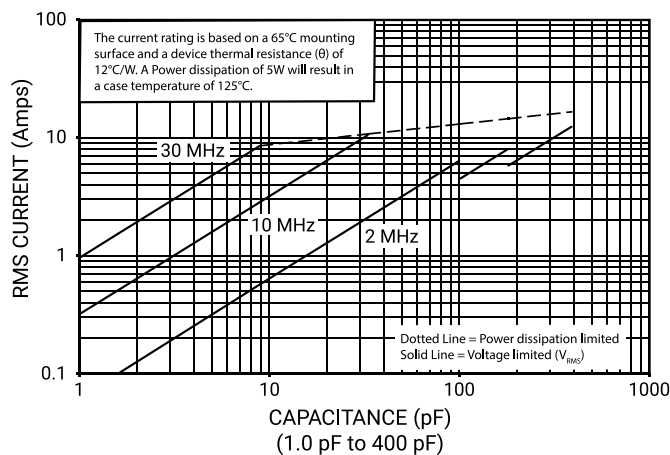

RF/Microwave Capacitors

RF/Microwave Multilayer Capacitors (MLC)

180R Series NPO Porcelain Ultra-Low ESR

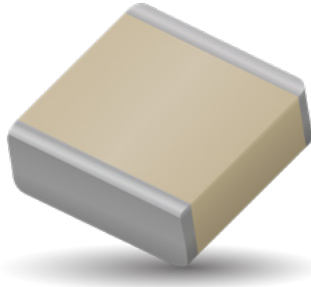

FEATURES

- Case R Size (.070" x .090")
- Capacitance Range 0.5pF to 100pF
- 500 WVDC
- Low ESR/ESL
- High Q
- Ultra-Stable Performance
- High Self-Resonance

GENERAL DESCRIPTION

KYOCERA AVX, the industry leader, offers new improved ESR/ESL performance for the 180R Series RF Capacitors. This is KYOCERA AVX's lowest ESR multilayer capacitor. The high Q, high self-resonance characteristic many RF/Microwave applications

FUNCTIONAL APPLICATIONS

- Bypass
- Coupling
- Tuning
- Feedback
- Impedance Matching
- DC Blocking

CIRCUIT APPLICATIONS

- RF Power Amplifiers
- Filters
- Oscillators
- Timing Circuits
- Delay Lines

ENVIRONMENTAL CHARACTERISTICS

Thermal Shock	Mil-STD-202, Method 107, Condition A
Moisture Resistance	Mil-STD-202, Method 106
Low Voltage Humidity	Mil-STD-202, Method 103, condition A, with 1.5 VDC applied while subjected to an environment of 85°C with 85% relative humidity for 240 hours
Life Test	MIL-STD-202, Method 108, for 2000 hours, at 125 °C. 200% WVDC applied

PACKAGING OPTIONS



Tape & Reel



Cap Pac
(100 pcs)



ELECTRICAL & MECHANICAL SPECIFICATIONS

Quality Factor (Q)	greater than 10,000 at 1 MHz
Temperature Coefficient of Capacitance (TCC)	0±30 PPM/°C (-55°C to +125°C) 0±60 PPM/°C (+125°C to +175°C)
Insulation Resistance (IR)	0.5 pF to 100 pF: 10 ⁶ Megohms min. @ +25°C at rated WVDC 10 ⁵ Megohms min. @ +125°C at rated WVDC 10 ⁴ Megohms min. above +125°C
Working Voltage (WVDC)	500 WVDC
Dielectric Withstanding Voltage (DWV)	Case R: 250% of rated WVDC for 5 secs.
Aging Effects	None
Piezoelectric Effects	None (no capacitance variation with voltage or pressure)
Capacitance Drift	±(0.02% or 0.02 pF), whichever is greater
Operating Temperature Range	-55°C to +175°C (No derating of working voltage)
Termination Style	See Mechanical Configuration
Terminal Strength	Termination for chips withstand a pull of 5 lbs. min., 15 lbs, for 5 seconds in direction perpendicular to the termination surface of the capacitor

RF/Microwave Capacitors

RF/Microwave Multilayer Capacitors (MLC)

180R Series NPO Porcelain Ultra-Low ESR



CAPACITANCE VALUES

Cap. Code	Cap. (pF)	Tol.	Rated WVDC	Cap. Code	Cap. (pF)	Tol.	Rated WVDC	Cap. Code	Cap. (pF)	Tol.	Rated WVDC
0R5	0.5	B, C, D	500	3R0	3.0	B, C, D	500	200	20	G, J, K, M	500
0R6	0.6			3R3	3.3			220	22		
0R7	0.7			3R6	3.6			240	24		
0R8	0.8			3R9	3.9			270	27		
0R9	0.9			4R3	4.3			300	30		
1R0	1.0			4R7	4.7			330	33		
1R1	1.1			5R1	5.1	360		36			
1R2	1.2			5R6	5.6	390		39			
1R3	1.3			6R2	6.2	430		43			
1R4	1.4			6R8	6.8	470		47			
1R5	1.5			7R5	7.5	510		51			
1R6	1.6			8R2	8.2	560		56			
1R7	1.7			9R1	9.1	620		62			
1R8	1.8			100	10	680		68			
1R9	1.9			110	11	750		75			
2R0	2.0			120	12	820		82			
2R1	2.1			130	13	910		91			
2R2	2.2			150	15	101		100			
2R4	2.4	160	16								
2R7	2.7	180	18								

VRMS = 0.707 X WVDC

HOW TO ORDER

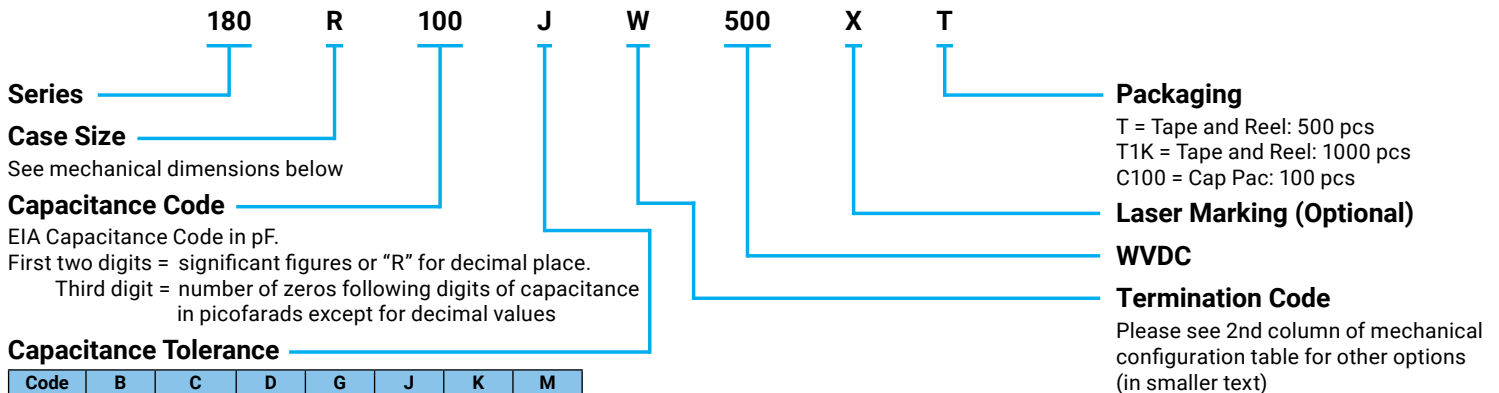

The above part number refers to a 180R Series (case size R) 10 pF capacitor, J tolerance (±5%), 500 WVDC, with W termination (Tin/Lead, Solder Plated over Nickel Barrier), laser marking and Tape and Reel packaging.

RF/Microwave Capacitors

RF/Microwave Multilayer Capacitors (MLC)

180R Series NPO Porcelain Ultra-Low ESR



MECHANICAL CONFIGURATION

Series & Case Size	Term. Code	Case Size & Type	Outline W/T is a Termination Surface	Body Dimensions inches (mm)			Lead and Termination Dimensions and Material	
				Length (L)	Width (W)	Thickness (T)	Overlap (Y)	Materials
180R	W	R Solder Plate		.070 ±.015 (1.78 ±0.38)	.090 ±.010 (2.29 ±0.25)	.115 (2.92) max.	.010+.010 - .005 (0.25+0.25 - 0.13)	Tin/Lead, Solder Plated over Nickel Barrier Termination
180R	T	R Solderable Nickel Barrier		.070 ±.015 (1.78 ±0.38)	.090 ±.010 (2.29 ±0.25)	.115 (2.92) max.	.010+.010 - .005 (0.25+0.25 - 0.13)	RoHS Compliant Tin Plated over Nickel Barrier Termination

All 180 R Capacitors are available laser marked with ATC's identification, capacitance code and tolerance.

SUGGESTED MOUNTING PAD DIMENSIONS

Horizontal
Electrode Orientation

Vertical
Electrode Orientation

Mount Type	Case R				
	Pad Size	A Min.	B Min.	C Min.	D Min.
Vertical Mount	Normal	.125	.050	.030	.130
	High Density	.115	.030	.030	.090
Horizontal Mount	Normal	.110	.050	.030	.130
	High Density	.090	.030	.030	.090

Dimensions are in inches.

PERFORMANCE DATA

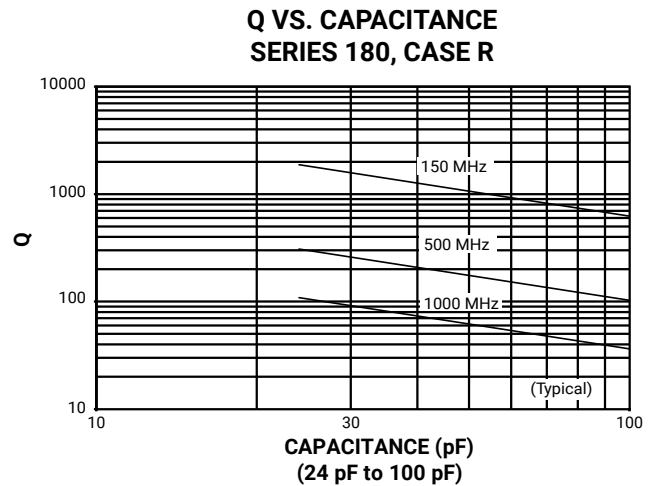
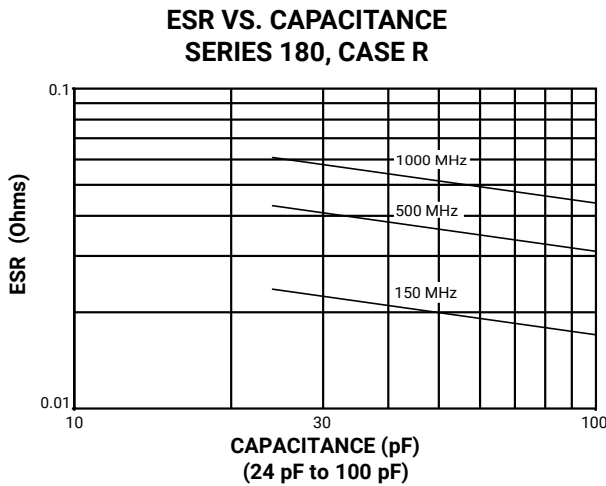
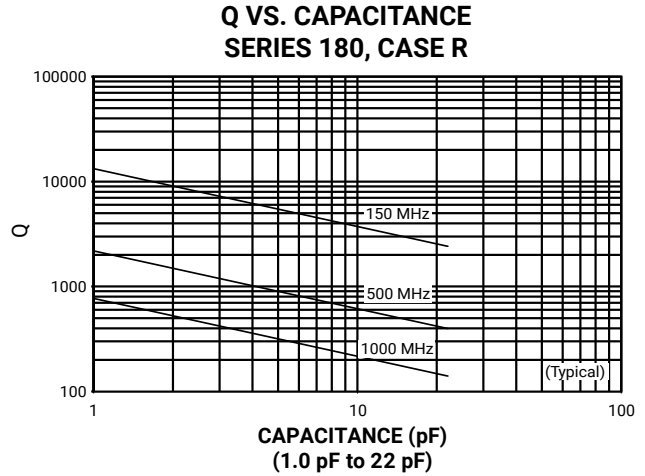
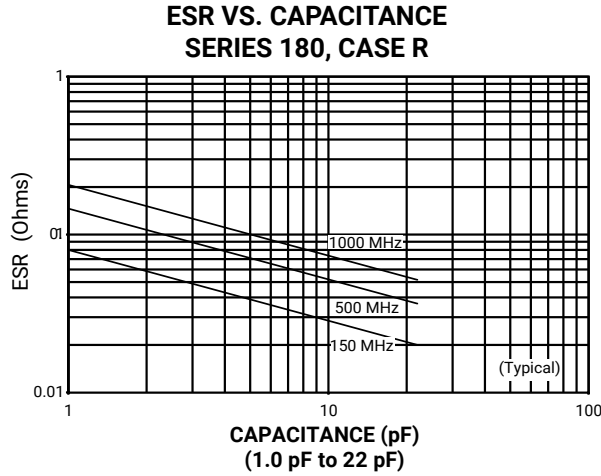

PERFORMANCE DATA

**SERIES RESONANCE VS. CAPACITANCE
 SERIES 180, CASE R**

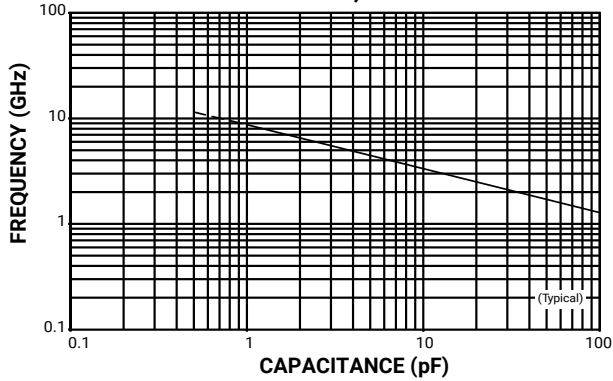

**CURRENT RATING VS. CAPACITANCE
 SERIES 180, CASE R**

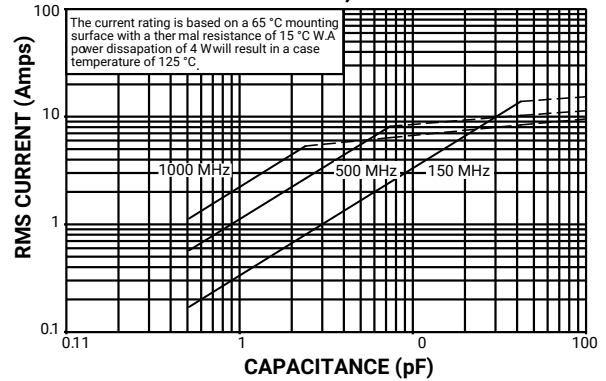

**CAPACITANCE CHANGE VS. TEMPERATURE
 SERIES 180, CASE R**

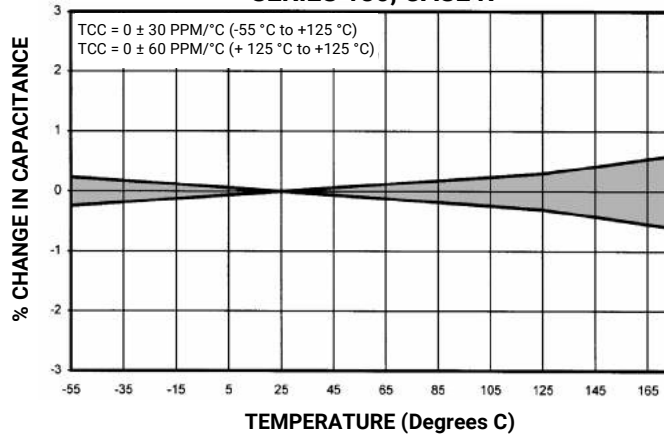

RF/Microwave Capacitors

RF/Microwave Multilayer Capacitors (MLC)

200A Series BX Ceramic

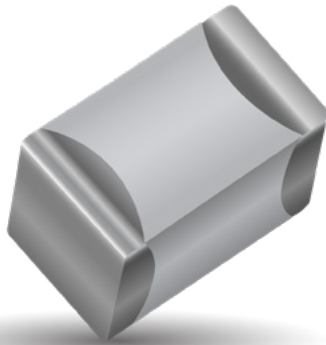

FEATURES

- Case A Size (.055" x .055")
- Lowest ESR/ESL
- Rugged Construction
- Extended WVDC Available
- Capacitance Range 510 pF to 0.01 μ F
- Mid-K
- High Reliability

GENERAL DESCRIPTION

KYOCERA AVX, the industry leader, offers new improved ESR/ESL performance for the 200A Series Capacitors. This Series exhibits high volumetric efficiency with superior IR characteristics. Ceramic construction provides a rugged, hermetic package.

Typical functional applications: Bypass, Coupling and DC Blocking. Typical circuit applications: Switching Power Supplies and High Power Broadband Coupling.

PACKAGING OPTIONS

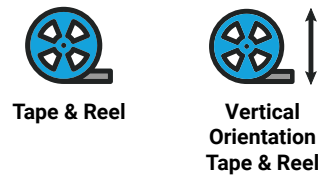

ELECTRICAL SPECIFICATIONS

Temperature Coefficient (TCC)	$\pm 15\%$ maximum (-55°C to +125°C)
Capacitance Range	510 pF to 0.01 μ F
Operating Temperature	-55°C to +125°C*
Dissipation Factor	2.5% Max @ 1 KHz
Insulation Resistance (IR)	510 pF to 0.01 μ F 10 ⁴ Megohms min. @ 25°C at rated WVDC 10 ³ Megohms min. @ 125°C at rated WVDC
Dielectric Absorption	2% Typical
Working Voltage (WVDC)	See Capacitance Values table
Dielectric Withstanding Voltage (DWV)	250% of rated WVDC for 5 seconds
Aging Effects	3% maximum per decade hour.
Piezoelectric Effects	Negligible
Capacitance Drift	\pm (0.02% or 0.02 pF), whichever is greater

ENVIRONMENTAL CHARACTERISTICS

Thermal Shock	Mil-STD-202, Method 107, Condition A
Moisture Resistance	Mil-STD-202, Method 106
Low Voltage Humidity	Mil-STD-202, Method 103, condition A, with 1.5 VDC applied while subjected to an environment of 85°C with 85% relative humidity for 240 hours
Life Test	MIL-STD-202, Method 108, for 2000 hours, at 125°C. 200% WVDC applied.
Termination Styles	Available in various surface mount styles. See Mechanical Configurations, page 3
Terminal Strength	Terminations for chips and Pellets withstand a pull of 5 lbs. min., 10 lbs. typical, for 5 seconds in direction perpendicular to the termination surface of the capacitor. Test per MIL-STD-202, method 211

RF/Microwave Capacitors

RF/Microwave Multilayer Capacitors (MLC)

200A Series BX Ceramic



CAPACITANCE VALUES

Cap. Code	Cap. (pF)	Tol.	Rated WVDC		Cap. Code	Cap. (pF)	Tol.	Rated WVDC	
			STD.	EXT.				STD.	EXT.
511	510	K, M, N	50	100	202	2000	K, M, N	50	100
561	560				222	2200			
621	620				272	2700			
681	680				332	3300			
751	750				392	3900			
821	820				472	4700			
911	910				502	5000			
102	1000				562	5600			
122	1200				682	6800			
152	1500				822	8200			
182	1800	103	10,000						

$v_{rms} = 0.707 \times WVDC$

Special values, tolerances, different WVDC and matching available. Please consult factory.

*Extended WVDC offering meets X7R characteristics

HOW TO ORDER

200 A 562 M W 50 X T

Series ————

Case Size ————
See mechanical dimensions below

Capacitance ————
EIA Capacitance Code in pF.
First two digits = significant figures or "R" for decimal place.
Third digit = number of zeros or after "R" significant figures

Capacitance Tolerance Code ————

Code	K	M	N
Tol.	±10%	±20%	±30%

Termination Style Code ————
Please see 2nd Column Mechanical Configuration Table

Packaging ————
T = Tape and Reel, 500 pc qty.
TV = Vertical Orientation of Product
Tape and Reel, 500 pc qty.
Please see last Column Mechanical Configuration Table for other options

Laser Marking (Optional) ————

Voltage Rating ————

The above part number refers to a 200 A Series (case size A) 5600 pF capacitor, M tolerance (±20%), 50 WVDC, with W termination (Tin / Lead, Solder Plated over Nickel Barrier), Laser Marking and Tape and Reel 1000 pc qty. Packaging

RF/Microwave Capacitors

RF/Microwave Multilayer Capacitors (MLC)

200A Series BX Ceramic



MECHANICAL CONFIGURATION

Series & Case Size	Term. Code	Case Size & Type	Outline W/T is a Termination Surface	Body Dimensions inches (mm)			Lead and Termination Dimensions and Material		Pkg Type & Qty	Pkg Code
				Length (L)	Width (W)	Thickness (T)	Overlap (Y)	Materials		
200A	W	A Solder Plate		.055+.015 -.010 (1.40+0.38-0.25)	.055 ±.015 (1.40 ±0.38)	.057 (1.45) max.	.010 + .010 - .005 (0.25 + 0.25 - 0.13)	Tin/ Lead, Solder Plated over Nickel Barrier Termination	T&R, 1000 or 500 pcs Vertical T&R, 1000 or 500 pcs Cap Pac, 100 pcs	T1K or T TV1k or TV C100
200A	P	A Pellet		.055+.025 -.010 (1.40+0.64-0.25)	.055 ±.015 (1.40 ±0.38)			Heavy Tin/ Lead Coated, over Nickel Barrier Termination	T&R, 1000 or 500 pcs Vertical T&R, 1000 or 500 pcs Cap Pac, 100 pcs	T1K or T TV1k or TV C100
200A	T	A Solderable Nickel Barrier		.055+.015 -.010 (1.40+0.38-0.25)	.055 ±.015 (1.40 ±0.38)			Tin Plated over Nickel Barrier Termination	T&R, 1000 or 500 pcs Vertical T&R, 1000 or 500 pcs Cap Pac, 100 pcs	T1K or T TV1k or TV C100
200A	CA	A Gold Chip		.055+.015 -.010 (1.40+0.38-0.25)	.055 ±.015 (1.40 ±0.38)			Gold Plated over Nickel Barrier Termination	T&R, 1000 or 500 pcs Vertical T&R, 1000 or 500 pcs Cap Pac, 100 pcs	T1K or T TV1k or TV C100

NON-MECHANICAL CONFIGURATION

Series & Case Size	Term. Code	Case Size & Type	Outline W/T is a Termination Surface	Body Dimensions inches (mm)			Lead and Termination Dimensions and Material		Pkg Type & Qty	Pkg Code
				Length (L)	Width (W)	Thickness (T)	Overlap (Y)	Materials		
200A	WN	A Non-Mag Solder Plate		.055+.015 -.010 (1.40+0.38-0.25)	.055 ±.015 (1.40 ±0.38)	.057 (1.45) max.	.010 + .010 - .005 (0.25 + 0.25 - 0.13)	Tin / Lead, Solder Plated over Non-Magnetic Barrier Termination	T&R, 1000 or 500 pcs Vertical T&R, 1000 or 500 pcs Cap Pac, 100 pcs	T1K or T TV1k or TV C100
200A	PN	A Non-Mag Pellet		.055+.025 -.010 (1.40+0.64-0.25)	.055 ±.015 (1.40 ±0.38)			Heavy Tin/Lead Coated, over Non-Magnetic Barrier Termination	T&R, 1000 or 500 pcs Vertical T&R, 1000 or 500 pcs Cap Pac, 100 pcs	T1K or T TV1k or TV C100
200A	TN	A Non-Mag Solderable Nickel Barrier		.055+.015 -.010 (1.40+0.38-0.25)	.055 ±.015 (1.40 ±0.38)			Tin Plated over Non-Magnetic Barrier Termination	T&R, 1000 or 500 pcs Vertical T&R, 1000 or 500 pcs Cap Pac, 100 pcs	T1K or T TV1k or TV C100

SUGGESTED MOUNTING PAD DIMENSIONS

Horizontal Electrode Orientation

Vertical Electrode Orientation

Case A					
Mount Type	Pad Size	A Min.	B Min.	C Min.	D Min.
Vertical Mount	Normal	.070	.050	.030	.130
	High Density	.050	.030	.030	.090
Horizontal Mount	Normal	.080	.050	.030	.130
	High Density	.060	.030	.030	.090

Dimensions are in inches.

PERFORMANCE DATA

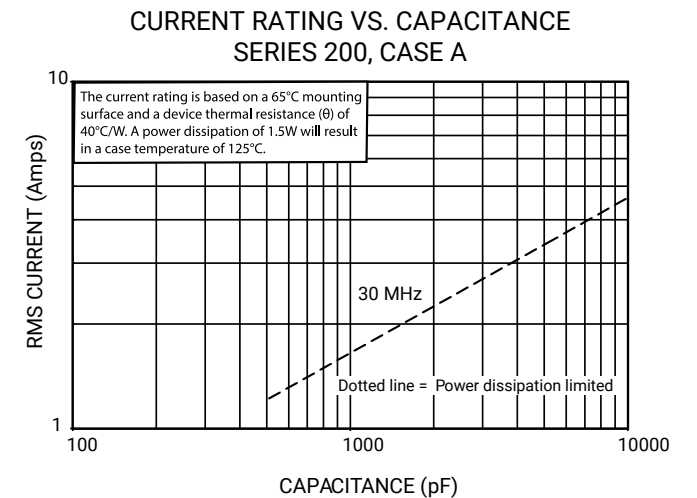
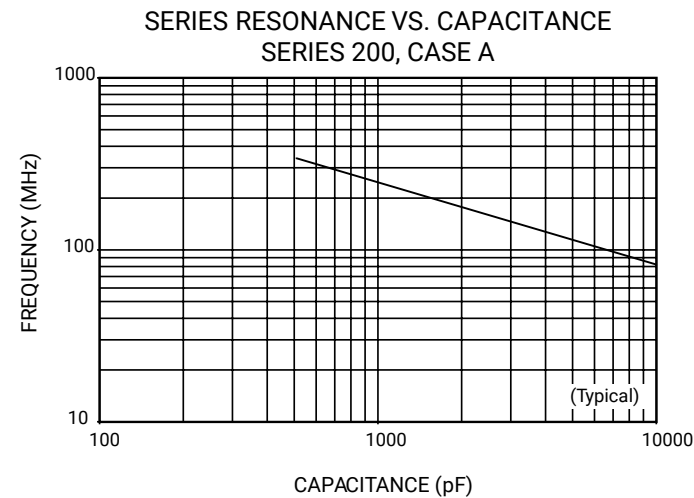
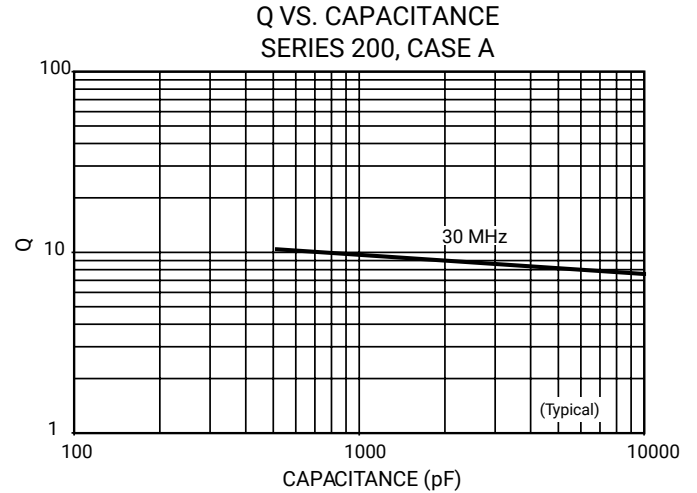
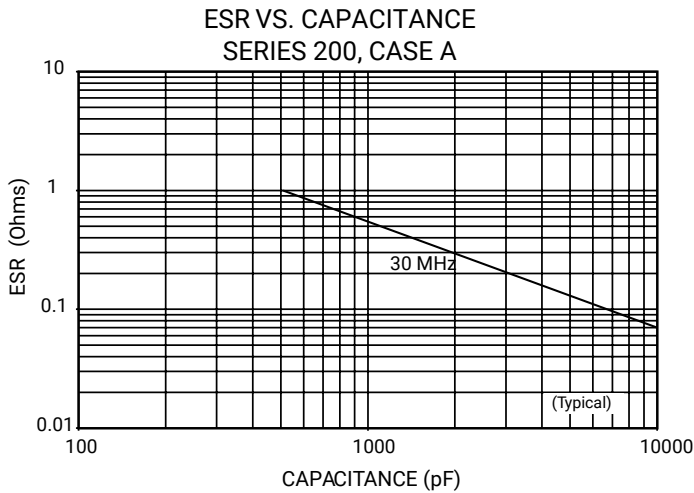

RF/Microwave Capacitors

RF/Microwave Multilayer Capacitors (MLC)

200B Series BX Ceramic

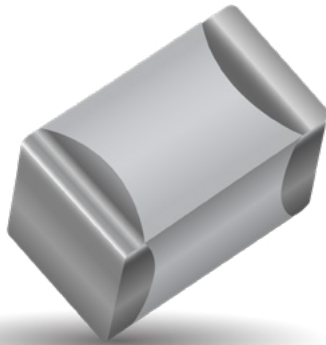

FEATURES

- Case B Size (.110" x .110")
- Lowest ESR/ESL
- Rugged Construction
- Extended WVDC Available
- Capacitance Range 5000 pF to 0.1 μ F
- Mid-K
- High Reliability

GENERAL DESCRIPTION

KYOCERA AVX, the industry leader, offers new improved ESR/ESL performance for the 200 B Series Capacitors. This Series exhibits high volumetric efficiency with superior IR characteristics. Ceramic construction provides a rugged, hermetic package.

Typical functional applications: Bypass, Coupling and DC Blocking.

Typical circuit applications: Switching Power Supplies and High Power Broadband Coupling.

PACKAGING OPTIONS



Tape & Reel



Vertical Orientation
Tape & Reel



Cap-Pak®
(100 pcs)

ELECTRICAL SPECIFICATIONS

Temperature Coefficient (TCC)	$\pm 15\%$ maximum (-55°C to +125°C)
Capacitance Range	510 pF to 0.01 μ F
Operating Temperature	From -55°C to +125°C (No derating of working voltage).
Dissipation Factor	2.5% max. @ 1 KHz
Insulation Resistance (IR)	5000 pF to 0.1 MFd: 10 ⁴ Megohms min. @ +25°C at rated WVDC. 10 ³ Megohms min. @ +125°C at rated WVDC.
Dielectric Absorption	2% Typical
Working Voltage (WVDC)	See Capacitance Values table
Dielectric Withstanding Voltage (DWV)	Case B: 250% of rated WVDC for 5 secs.
Aging Effects	3% maximum per decade hour.
Piezoelectric Effects	Negligible
Capacitance Drift	\pm (0.02% or 0.02 pF), whichever is greater

ENVIRONMENTAL CHARACTERISTICS

Thermal Shock	MIL-STD-202, Method 107, Condition A.
Moisture Resistance	MIL-STD-202, Method 106.
Low Voltage Humidity	MIL-STD-202, Method 103, Condition A, with 1.5 Volts DC applied while subjected to an environment of 85°C with 85% relative humidity for 240 hours min.
Life Test	MIL-STD-202, Method 108, for 2000 hours, at 125°C. 200% WVDC applied.
Termination Styles	Available in various surface mount styles. See Mechanical Configurations, page 3
Terminal Strength	Terminations for chips and Pellets withstand a pull of 5 lbs. min., 10 lbs. typical, for 5 seconds in direction perpendicular to the termination surface of the capacitor. Test per MIL-STD-202, method 211

RF/Microwave Capacitors

RF/Microwave Multilayer Capacitors (MLC)

200B Series BX Ceramic



CAPACITANCE VALUES

CAP. CODE	CAP. (pF)	TOL.	RATED WVDC		CAP. CODE	CAP. (pF)	TOL.	RATED WVDC	
			STD	EXT.*				STD	EXT.*
502	5000	K, M, N	50	VOLTAGE	273	27,000	K, M, N	50	VOLTAGE
562	5600				333	33,000			
682	6800				393	39,000			
822	8200				473	47,000			
103	10,000				503	50,000			
123	12,000				563	56,000			
153	15,000		EXTENDED	100	683	68,000		EXTENDED	
183	18,000				823	82,000			
203	20,000				104	100,000			
223	22,000								

VRMS = 0.707 x WVDC

• SPECIAL VALUES, TOLERANCES, HIGHER WVDC AND MATCHING AVAILABLE. PLEASE CONSULT FACTORY.

* Extended WVDC offering meets X7R characteristics

HOW TO ORDER

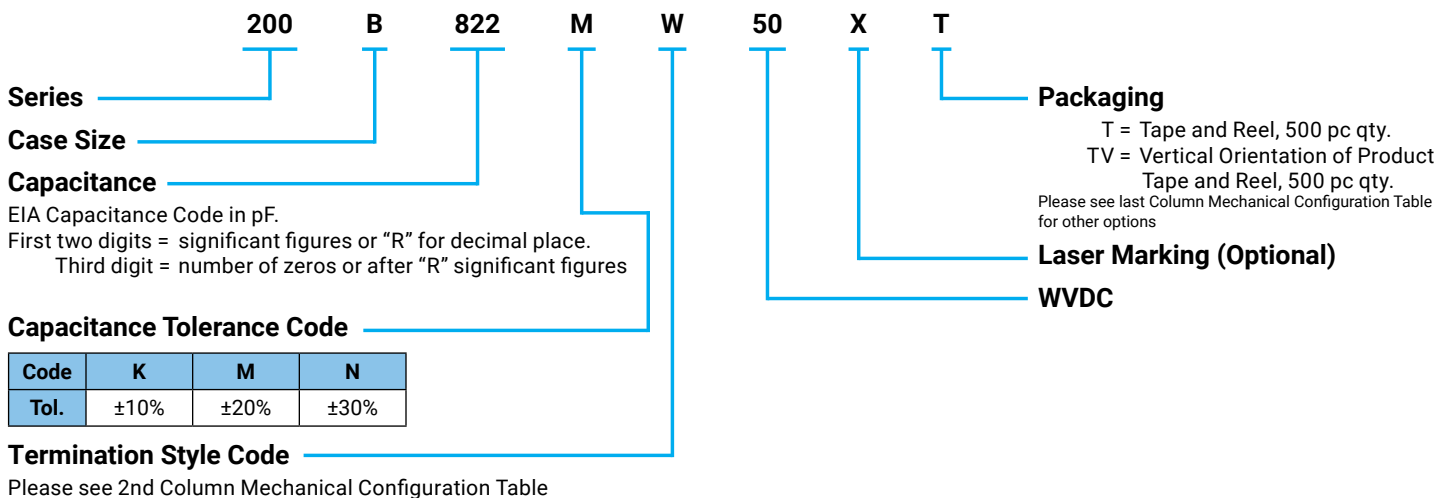

The above part number refers to a 200 B Series (case size B) 8200 pF capacitor, M tolerance (±20%), 50 WVDC, with W termination (Tin / Lead, Solder Plated over Nickel Barrier), laser marking and KYOCERA AVX Cap-Pac® packaging.

RF/Microwave Capacitors

RF/Microwave Multilayer Capacitors (MLC)

200B Series BX Ceramic



MECHANICAL CONFIGURATION

SERIES & CASE SIZE	TERM. CODE	CASE SIZE & TYPE	OUTLINES W/T IS A TERMINATION SURFACE	BODY DIMENSIONS INCHES (mm)			LEAD AND TERMINATION DIMENSIONS AND MATERIALS			Pkg Type	Pkg Code	
				LENGTH (L)	WIDTH (W)	THICKNESS (T)	OVERLAP (Y)	MATERIALS				
200B	W	B Solder Plate		.110 +.020 -.010 (2.79 +0.51 -0.25)	.110 ±.015 (2.79 ±0.38)	.102 (2.59) max.	.015 (0.38) ±.010 (0.25) max.	Tin/Lead, Solder Plated over Nickel Barrier Termination			T&R, 1000 or 500 pcs Vertical T&R, 1000 pcs or 500 pcs Cap Pac, 100 pcs	T1K or T TV1K or TV C100
200B	P	B Pellet		.110 +.035 -.010 (2.79 +0.89 -0.25)	.110 ±.015 (2.79 ±0.38)	.102 (2.59)		Heavy Tin/Lead Coated, over Nickel Barrier Termination			T&R, 1000 or 500 pcs Vertical T&R, 1000 pcs or 500 pcs Cap Pac, 100 pcs	T1K or T TV1K or TV C100
200B	T	B Solderable Nickel Barrier		.110 +.020 -.010 (2.79 +0.51 -0.25)	.110 ±.015 (2.79 ±0.38)	.102 (2.59)		RoHS Compliant Tin Plated over Nickel Barrier Termination			T&R, 1000 or 500 pcs Vertical T&R, 1000 pcs or 500 pcs Cap Pac, 100 pcs	T1K or T TV1K or TV C100
200B	CA	B Gold Chip		.110 +.020 -.010 (2.79 +0.51 -0.25)	.110 ±.015 (2.79 ±0.38)	.102 (2.59)		RoHS Compliant Gold Plated over Nickel Barrier Termination			T&R, 1000 or 500 pcs Vertical T&R, 1000 pcs or 500 pcs Cap Pac, 100 pcs	T1K or T TV1K or TV C100
200B	MS	B Microstrip		.135 ±.015 (3.43 ±0.38)	.110 ±.015 (2.79 ±0.38)	.120 (3.05) max.	N/A	Length (LL)	Width (WL)	Thickness (TL)	Cap Pac, 20 pcs	C20
200B	AR	B Axial Ribbon				.250 (6.35) min.					.093 ± .005 (2.36 ± 0.13)	
200B	RR	B Radial Ribbon				.100 (2.54) max.		Box, 20 or 100 pcs	B20 or B100			
200B	RW	B Radial Wire		.145 ±.020 (3.68 ±0.51)	.500 (12.7)	#26 AWG., .016 (.406) dia. nominal		Box, 20 or 100 pcs	B20 or B100			
200B	AW	B Axial Wire						Box, 20 or 100 pcs	B20 or B100			

RF/Microwave Capacitors

RF/Microwave Multilayer Capacitors (MLC)

200B Series BX Ceramic



NON-MECHANICAL CONFIGURATION

SERIES & CASE SIZE	TERM. CODE	MIL-PRF-55681	CASE SIZE & TYPE	OUTLINES W/T IS A TERMINATION SURFACE	BODY DIMENSIONS INCHES (mm)			LEAD AND TERMINATION DIMENSIONS AND MATERIALS			Pkg Type	Pkg Code								
					LENGTH (L)	WIDTH (W)	THICKNESS (T)	OVERLAP (Y)	MATERIALS											
200B	WN	Meets Rqmts.	B Non-Mag Solder Plate		.110+0.025 -0.10 (2.79 +0.64 -0.25)	.110 ±0.15 (2.79 ±0.38)				Tin/Lead, Solder Plated over Non-Magnetic Barrier Termination	T&R, 1000 or 500 pcs Vertical T&R, 1000 pcs or 500 pcs Cap Pac, 100 pcs	T1K or T TV1K or TV C100								
200B	PN	Meets Rqmts.	B Non-Mag Pellet		.110+0.035 -0.10 (2.79 +0.89 -0.25)	.110 ±0.15 (2.79 ±0.38)					.102 (2.59) max..	.015 (0.38) ±.010 (0.25)	Heavy Tin/Lead, Coated over Non-Magnetic Barrier Termination	T&R, 1000 or 500 pcs Vertical T&R, 1000 pcs or 500 pcs Cap Pac, 100 pcs	T1K or T TV1K or TV C100					
200B	TN	Meets Rqmts.	B Non-Mag Solderable Barrier		.110+0.025 -0.10 (2.79 +0.64 -0.25)	.110 ±0.15 (2.79 ±0.38)							RoHS Compliant Tin Plated over Non-Magnetic Barrier Termination	T&R, 1000 or 500 pcs Vertical T&R, 1000 pcs or 500 pcs Cap Pac, 100 pcs	T1K or T TV1K or TV C100					
200B	MN	Meets Rqmts.	B Non-Mag Microstrip								Cap Pac, 20 pcs	C20								
200B	AN	Meets Rqmts.	B Non-Mag Axial Ribbon										.135 ±0.15 (3.43 ±0.38)						Box, 20 or 100 pcs	B20 or B100
200B	FN	Meets Rqmts.	B Non-Mag Radial Ribbon										.110 ±0.15 (2.79 ±0.38)							
200B	RN	Meets Rqmts.	B Non-Mag Axial Wire								Box, 20 or 100 pcs	B20 or B100								
200B	BN	Meets Rqmts.	B Non-Mag RadialWire										.145 ±0.020 (3.68 ±0.51)						Box, 20 or 100 pcs	B20 or B100

Additional lead styles available: Narrow Microstrip (DN), Narrow Axial Ribbon (GN) and Vertical Narrow Microstrip (HN). Other lead lengths are available; consult factory. All leads are high purity silver attached with high temperature solder and are RoHS compliant.

RF/Microwave Capacitors

RF/Microwave Multilayer Capacitors (MLC)

200B Series BX Ceramic



SUGGESTED MOUNTING PAD DIMENSIONS

Horizontal
Electrode Orientation

Vertical
Electrode Orientation

Dimensions are in inches.

	Pad Size	A Min.	B Min.	C Min.	D Min.
All Values	Normal	.120	.050	.075	.175
	High Density	.100	.030	.075	.135

Horizontal Mount

	Pad Size	A Min.	B Min.	C Min.	D Min.
All Values	Normal	.130	.050	.075	.175
	High Density	.110	.030	.075	.135

PERFORMANCE DATA

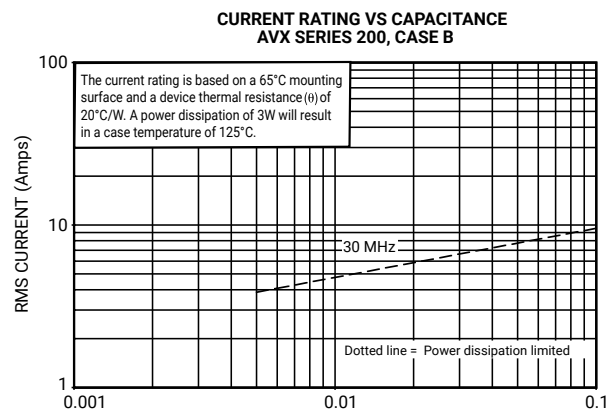
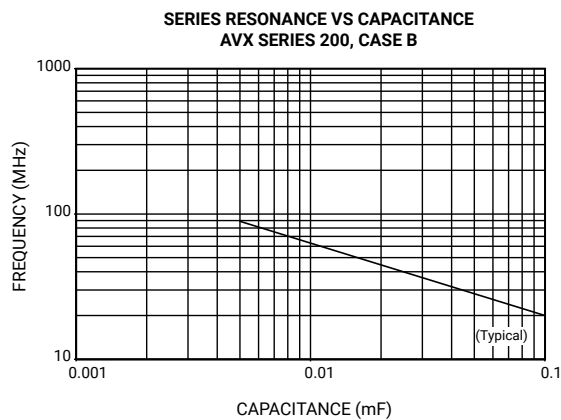
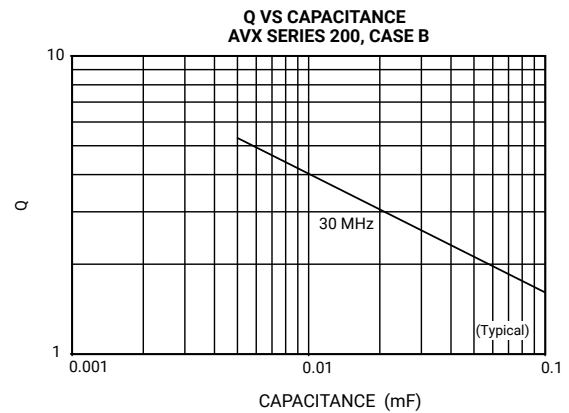
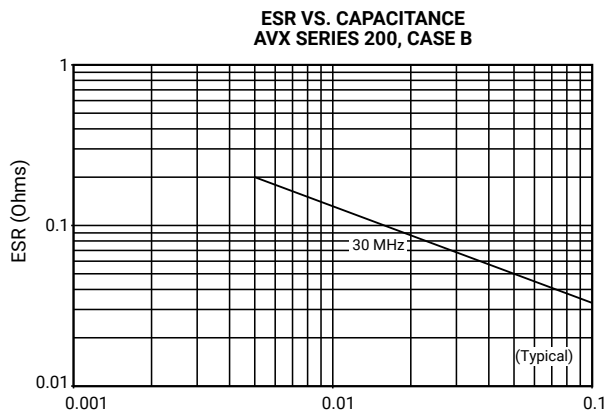

RF/Microwave Capacitors

RF/Microwave Multilayer Capacitors (MLC)

530L Series Broadband Multilayer Capacitors

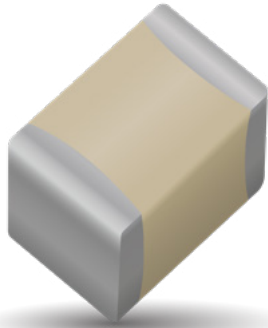

GENERAL DESCRIPTION

KYOCERA AVX's new 530L Series Multilayer Broadband Capacitor provides low insertion loss performance over multiple octaves of frequency spectrum. The 530L capacitor is compatible with high speed automated pick and place SMT manufacturing..

FUNCTIONAL APPLICATIONS

- DC Blocking
- Coupling
- Bypassing
- Feedback

FEATURES

- EIA 0402 Case Size
- Operating Frequency: 16 KHz to 18 GHz
- Insertion Loss: 1 dB max.
- Low Loss X7R Dielectric
- RoHS Compliant Terminations
- Solderable SMT Terminations

ADVANTAGES

- Broadband Performance
- Low Insertion Loss
- Flat Frequency Response
- Excellent Return Loss through 18 GHz
- Unit-to-Unit Performance Repeatability
- Rugged Ceramic Construction

530L Insertion Loss (S21)

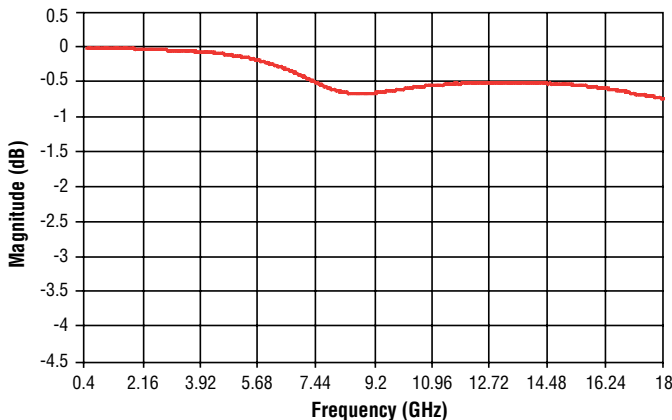

530L Return Loss (S11)

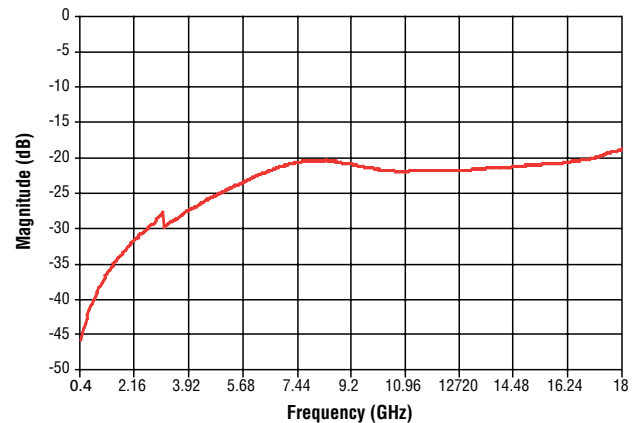

RF/Microwave Capacitors

RF/Microwave Multilayer Capacitors (MLC)

530L Series Broadband Multilayer Capacitors



ELECTRICAL SPECIFICATIONS

Capacitance	100 nF
Rated Voltage	16 WVDC
Dielectric Withstanding Voltage	250% of rated WVDC for 5 secs.
Operating Temperature Range	-55°C to +85°C
Temperature Coefficient of Capacitance	±15% (-55°C to +125°C)
Maximum DF	10% @ 1KHz
Insulation Resistance	10 ¹⁰ Ω min. @ +25°C @ rated WVDC 10 ⁹ Ω min. @ +85°C @ rated WVDC

MECHANICAL DIMENSIONS

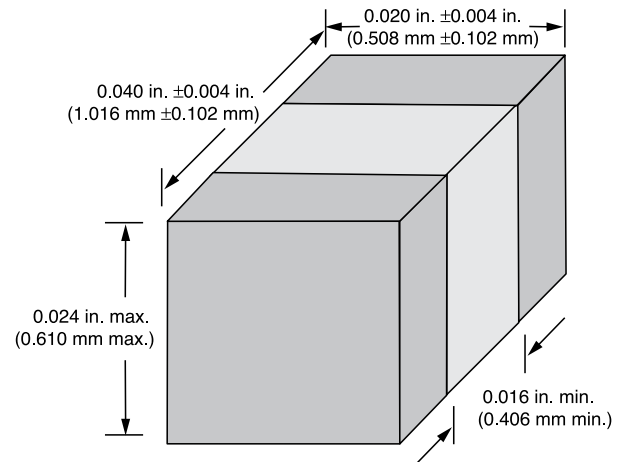

HOW TO ORDER

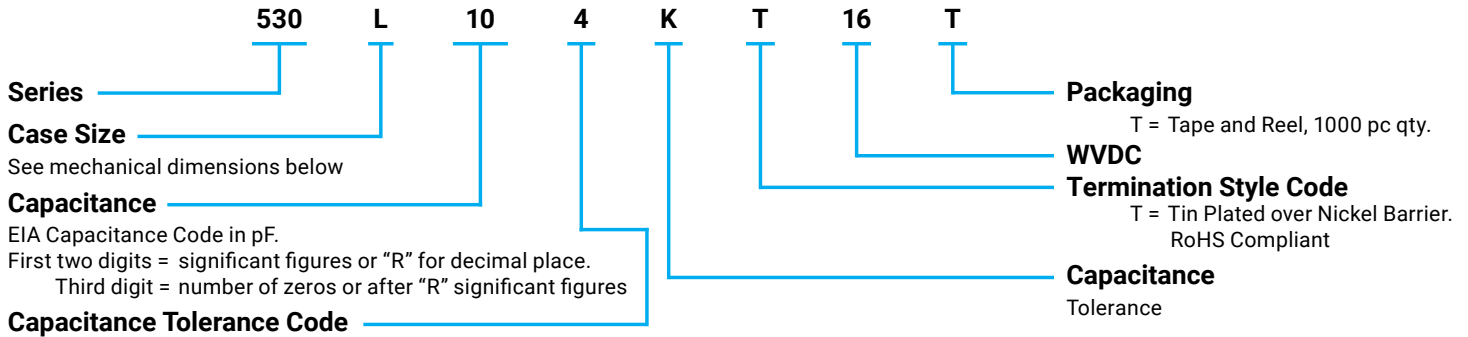

Code	M
Tol.	±20%

The above part number refers to a 530 Series (case size U) 100 nF capacitor, M tolerance (±20%), with T termination (Tin Plated over Nickel Barrier), tape and reel packaging, 4000 pc qty.

RF/Microwave Capacitors

RF/Microwave Multilayer Capacitors (MLC)

550-560 Series UBC™ Ultra-Broadband Capacitor

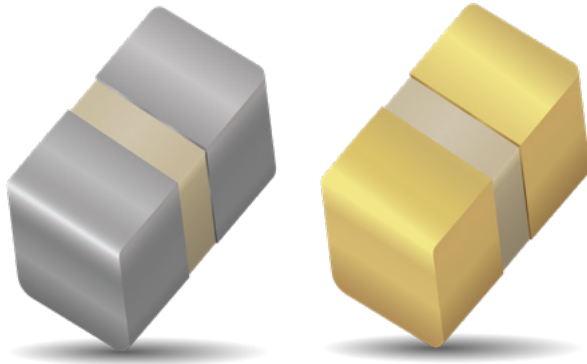

GENERAL DESCRIPTION

KYOCERA AVX new Ultra-Broadband Capacitor is manufactured with highest quality materials to provide reliable and repeatable Ultra-Broadband performance from 16KHz through 70+ GHz. It exhibits ultra-low insertion loss, flat frequency response and excellent return loss, and is ideal for D.C. Blocking, Coupling, Bypassing and Feedback applications requiring Ultra-Broadband performance.

TYPICAL CIRCUIT APPLICATIONS

- Optoelectronics/High Speed Data
- Transimpedance amplifiers
- Receive and Transmit Optical Sub-Assembly (ROSA/TOSA)
- Synchronous Optical Network (SONET)
- Broadband test equipment
- Broadband Microwave/Millimeter Wave

ADVANTAGES

- Ultra-Broadband performance
- Ultra-Low Insertion Loss
- Flat Frequency Response
- Excellent Return Loss
- Unit-to-Unit Performance Repeatability
- Rugged Ceramic Construction

HOW TO ORDER

550 T Series 550	Z T Case Size Z = 0201 L = 0402 W = 01005	104 T Capacitance Code EIA Capacitance Code in pF. First two digits = significant figures or "R" for decimal place. Third digit = number of zeros or after "R" significant figures	K T Capacitance Tolerance Code K = ±10% M = ±20% P = +100%, -0% V = +20%, -10% Y = +25%, -20%	T T Termination Style Code T = Tin Plated over Nickel Barrier (Standard) CA = Gold Plated over Nickel Barrier	T T Packaging T = 1000 pc qty. T/500 = 500 pc qty. T/4k = 4000 pc qty. Z = 15K pc for 0201, 20kpc for 01005
---	--	---	--	---	---



ELECTRICAL SPECIFICATIONS

Series	Size (EIA)	Min Frequency	Max Frequency	Cap (nF)	WVDC (85C)	WVDC (105C)	WVDC (125C)	Finish	Packaging
550W103M	01005	160kHz	70GHz	10	35	25	16	Tin	T, Z
560W104M	01005	16kHz	40GHz	100	6.3	4	4	Tin	
560Z104M	0201	16kHz	40GHz	100	16	16	10	Tin	
550Z104M	0201	16kHz	70GHz	100	16	16	10	Tin	
560Z224M	0201	7.2kHz	40GHz	220	10	10	6.3	Tin	
550Z224M	0201	7.2kHz	70GHz	220	10	10	6.3	Tin	
550Z103P	0201	160kHz	70GHz	10	10	10	6.3	Tin/Gold	T T/500 T/4K
560L104Y	0402	16kHz	40GHz	100	16	16	16	Tin	
550L104K	0402	16kHz	70GHz	100	16	16	16	Tin/Gold	

↑ Click on part number to see performance data and download files

RF/Microwave Capacitors

RF/Microwave Multilayer Capacitors (MLC)

550-560 Series UBC™ Ultra-Broadband Capacitor



GENERAL DIMENSIONS

		560W104	560Z104	560Z224	560L104
L (Length)	mm	0.40 ± 0.02	0.60 ± 0.03	0.60 ± 0.03	1.0 ± 0.1
	(in)	(0.016 ± 0.0008)	(0.024 ± 0.001)	(0.024 ± 0.001)	(0.040 ± 0.004)
W (Width)	mm	0.20 ± 0.02	0.30 ± 0.03	0.30 ± 0.03	0.5 ± 0.1
	(in)	(0.008 ± 0.0008)	(0.011 ± 0.001)	(0.011 ± 0.001)	(0.020 ± 0.004)
T (Thickness)	mm	0.22 Max	0.22 Max	0.33 Max	0.6 Max
	(in)	0.009 Max	0.009 Max	0.013 Max	0.024 Max
t (Terminal)	mm	0.135 ± 0.035	0.15 ± 0.05	0.15 ± 0.05	0.36 ± 0.08
	(in)	(0.005 ± 0.0014)	(0.006 ± 0.002)	(0.006 ± 0.002)	(0.014 ± 0.003)

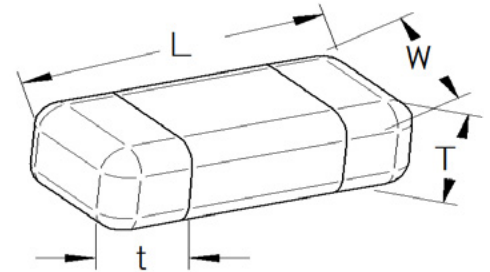

		550W103	550Z103	550Z104	550Z224	550L104
L (Length)	mm	0.40 ± 0.02	0.58 ± 0.03	0.60 ± 0.03	0.60 ± 0.03	1.0 ± 0.1
	(in)	(0.016 ± 0.0008)	(0.023 ± 0.001)	(0.024 ± 0.001)	(0.024 ± 0.001)	(0.040 ± 0.004)
W (Width)	mm	0.20 ± 0.02	0.30 ± 0.03	0.30 ± 0.03	0.30 ± 0.03	0.5 ± 0.1
	(in)	(0.008 ± 0.0008)	(0.011 ± 0.001)	(0.011 ± 0.001)	(0.011 ± 0.001)	(0.020 ± 0.004)
T (Thickness)	mm	0.2 Max	0.33 Max	0.22 Max	0.33 Max	0.6 Max
	(in)	0.008 Max	0.013 Max	0.009 Max	0.013 Max	0.024 Max
t (Terminal)	mm	0.135 ± 0.035	0.20 ± 0.04	0.23 ± 0.05	0.23 ± 0.05	0.42 ± 0.08
	(in)	(0.005 ± 0.0014)	(0.008 ± 0.0015)	(0.009 ± 0.002)	(0.009 ± 0.002)	(0.0165 ± 0.0030)

REFLOW SOLDERING

560		01005	0201	0402
a	mm	0.10 - 0.15	0.20 - 0.25	0.40 - 0.60
	(in)	(0.004 - 0.006)	(0.008 - 0.010)	(0.016 - 0.024)
b	mm	0.13 - 0.19	0.25 - 0.35	0.40 - 0.50
	(in)	(0.005 - 0.007)	(0.010 - 0.014)	(0.016 - 0.020)
c	mm	0.20 - 0.23	0.30 - 0.40	0.50 - 0.75
	(in)	(0.008 - 0.009)	(0.012 - 0.016)	(0.020 - 0.030)

550		01005	0201	0402
a	mm	0.10 - 0.15	0.10 - 0.15	0.15 - 0.20
	(in)	(0.004 - 0.006)	(0.004 - 0.006)	(0.006 - 0.008)
b	mm	0.13 - 0.19	0.30 - 0.40	0.50 - 0.62
	(in)	(0.005 - 0.007)	(0.012 - 0.016)	(0.020 - 0.025)
c	mm	0.20 - 0.23	0.30 - 0.40	0.50 - 0.75
	(in)	(0.008 - 0.009)	(0.012 - 0.016)"	(0.020 - 0.030)

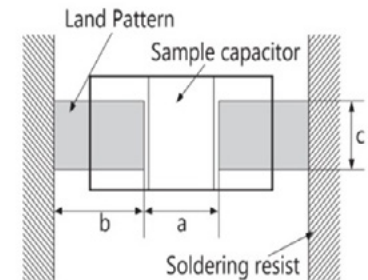

Parts are sensitive to orientation. Maintain packaging orientation for typical performance.

RF/Microwave Capacitors

RF/Microwave Multilayer Capacitors (MLC)

550-560 Series UBC™ Ultra-Broadband Capacitor



Size (EIA)	Min Frequency	Max Frequency	Cap (nF)	WVDC (85C)	WVDC (105C)	WVDC (125C)	Finish
01005	160kHz	70GHz	10	35	25	16	Tin

[Click here to return to main table](#)

PERFORMANCE DATA

Series Insertion Loss (S21)

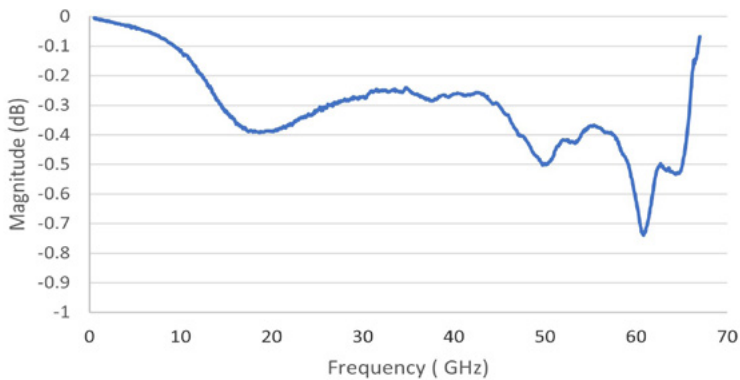

Series Return Loss (S11)

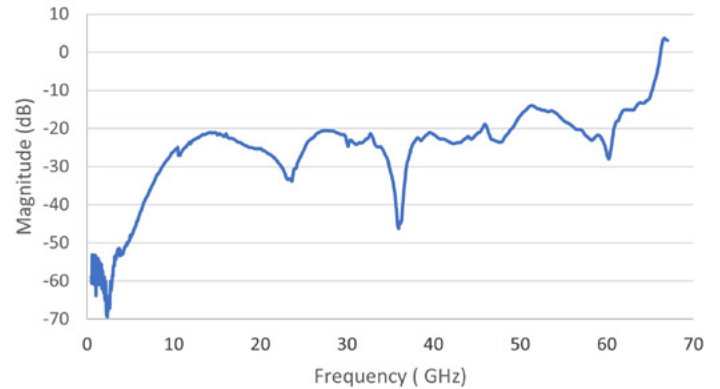

550W Data Sheet Test Condition Description

All testing performed on 10-mil-thick Rogers RO3006 microstrip board, with the device under test subtending a 4 mil gap in a 14.2-mil-wide center trace (nominal 50-ohm characteristic impedance).

560W104M

Size (EIA)	Min Frequency	Max Frequency	Cap (nF)	WVDC (85C)	WVDC (105C)	WVDC (125C)	Finish
01005	16kHz	40GHz	100	6.3	4	4	Tin

[Click here to return to main table](#)

PERFORMANCE DATA

Series Insertion Loss (S21)

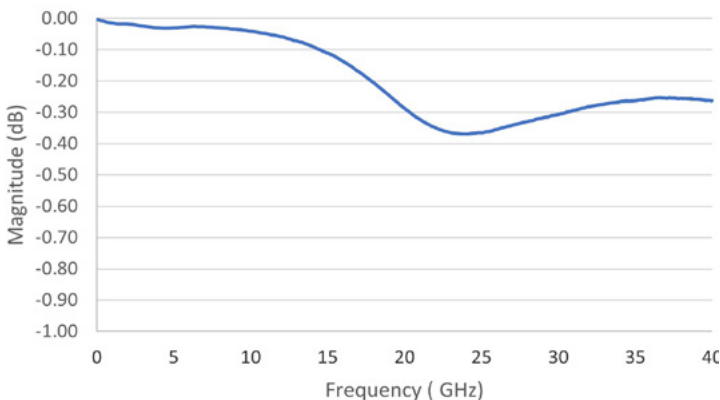

Series Return Loss (S11)

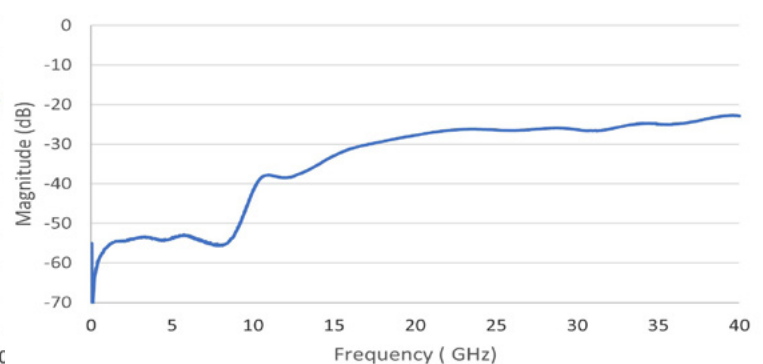

560W Data Sheet Test Condition Description

All testing performed on 10-mil-thick Rogers RO3006 microstrip board, with the device under test subtending a 4 mil gap in a 14.2-mil-wide center trace (nominal 50-ohm characteristic impedance).

RF/Microwave Capacitors

RF/Microwave Multilayer Capacitors (MLC)

550-560 Series UBC™ Ultra-Broadband Capacitor



Size (EIA)	Min Frequency	Max Frequency	Cap (nF)	WVDC (85C)	WVDC (105C)	WVDC (125C)	Finish
0201	16kHz	40GHz	100	16	16	10	Tin

[Click here to return to main table](#)

PERFORMANCE DATA

Insertion Loss (S21)

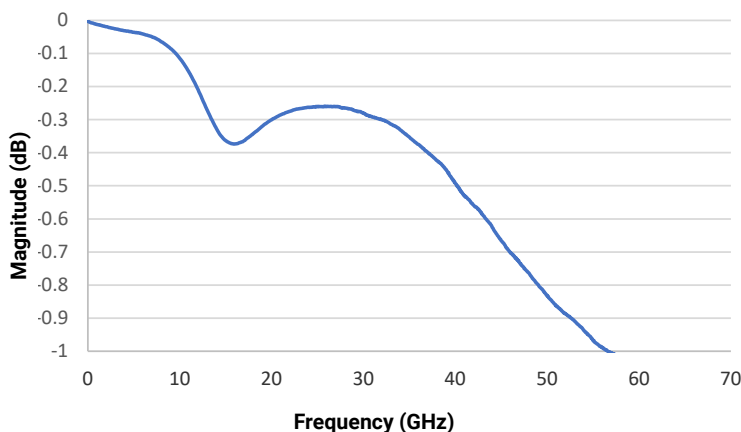

Return Loss (S11)

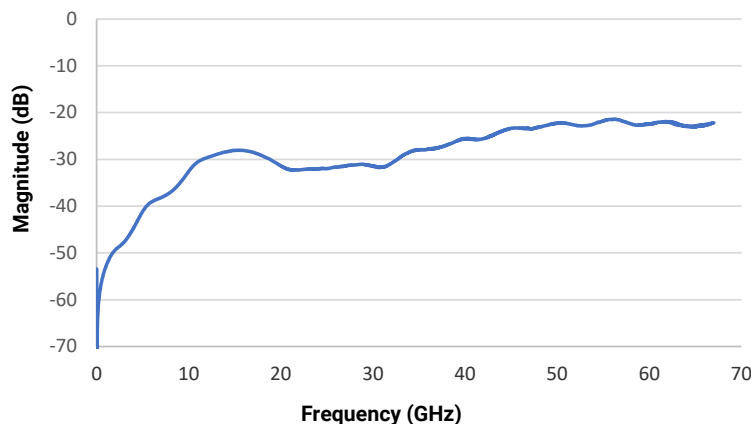

560Z Data Sheet Test Condition Description

All testing performed on 10-mil-thick Rogers RO3006 microstrip board, with the device under test subtending a 24 mil gap in a 14.2-mil-wide center trace (nominal 50-ohm characteristic impedance).

550Z104M

Size (EIA)	Min Frequency	Max Frequency	Cap (nF)	WVDC (85C)	WVDC (105C)	WVDC (125C)	Finish
0201	16kHz	70GHz	100	16	16	10	Tin

[Click here to return to main table](#)

PERFORMANCE DATA

Series Insertion Loss (S21)

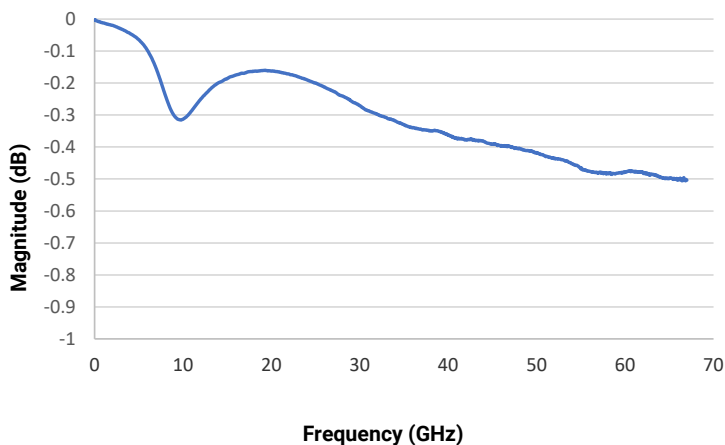

Series Return Loss (S11)

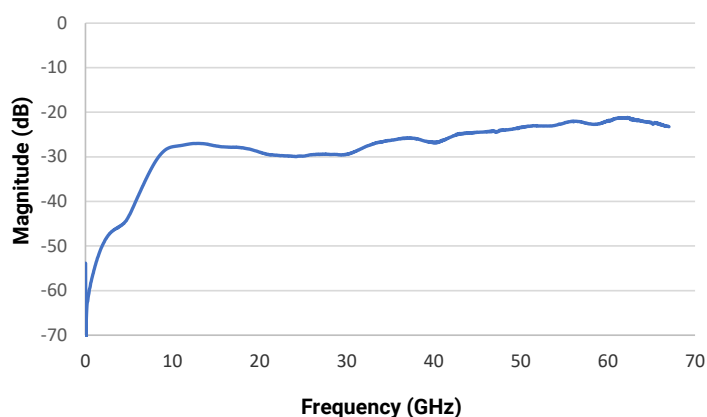

550Z Data Sheet Test Condition Description

All testing performed on 10 mil-thick rogers RO3006 microstrip board, with the device under test subtending a 10 mil gap in a 14.2 mil-wide center trace (nominal 50 ohms characteristic impedance).

RF/Microwave Capacitors
RF/Microwave Multilayer Capacitors (MLC)
550-560 Series UBC™ Ultra-Broadband Capacitor



560Z224M

Size (EIA)	Min Frequency	Max Frequency	Cap (nF)	WVDC (85C)	WVDC (105C)	WVDC (125C)	Finish
0201	7.2kHz	40GHz	220	10	10	6.3	Tin

[Click here to return to main table](#)

PERFORMANCE DATA

Insertion Loss (S21)

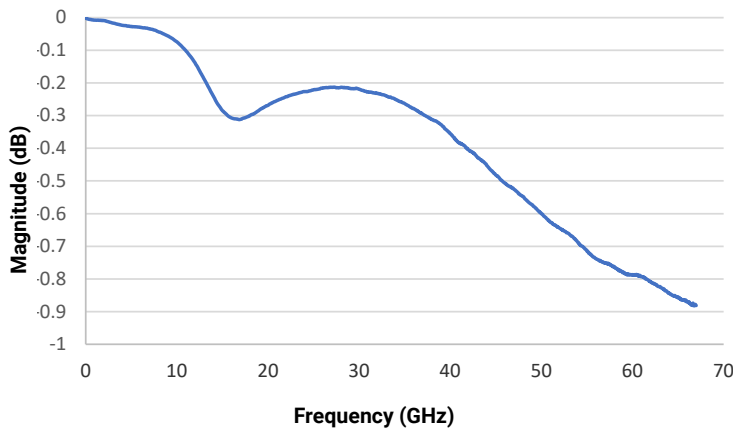

Return Loss (S11)

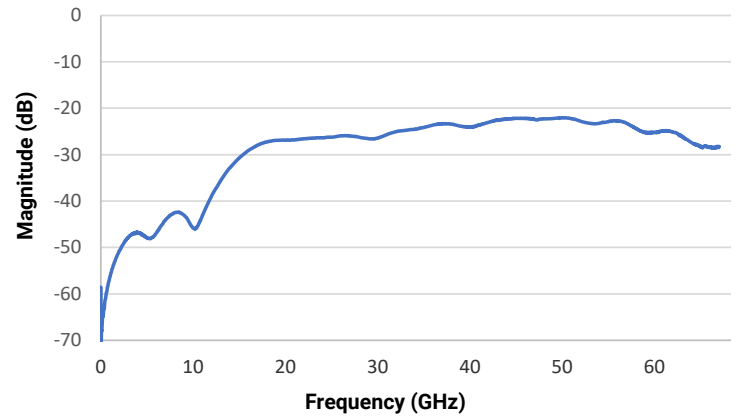

560Z Data Sheet Test Condition Description

All testing performed on 10 mil-thick rogers RO3006 microstrip board, with the device under test subtending a 10 mil gap in a 14.2 mil-wide center trace (nominal 50 ohms characteristic impedance).

550Z224M

Size (EIA)	Min Frequency	Max Frequency	Cap (nF)	WVDC (85C)	WVDC (105C)	WVDC (125C)	Finish
0201	7.2kHz	70GHz	220	10	10	6.3	Tin

[Click here to return to main table](#)

PERFORMANCE DATA

Series Insertion Loss (S21)

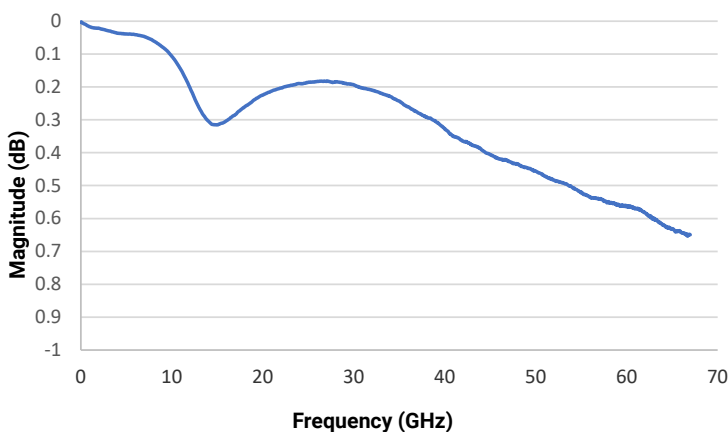

Series Return Loss (S11)

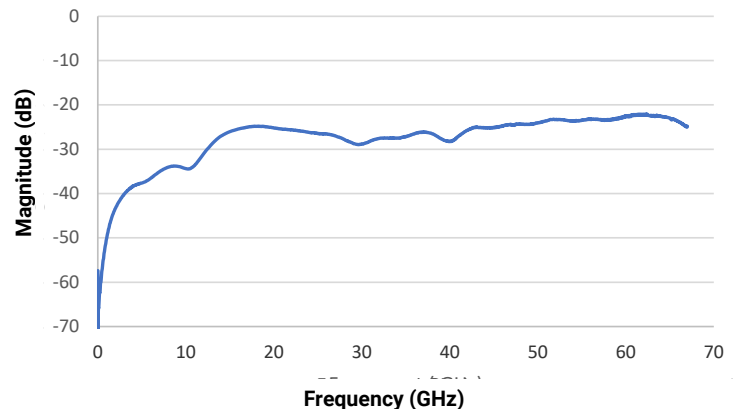

550Z Data Sheet Test Condition Description

All testing performed on 10 mil-thick rogers RO3006 microstrip board, with the device under test subtending a 10 mil gap in a 14.2 mil-wide center trace (nominal 50 ohms characteristic impedance).



The Important Information/Disclaimer is incorporated in the catalog where these specifications came from or available online at www.kyocera-avx.com/disclaimer/ by reference and should be reviewed in full before placing any order.

RF/Microwave Capacitors

RF/Microwave Multilayer Capacitors (MLC)

550-560 Series UBC™ Ultra-Broadband Capacitor



550Z103P

Size (EIA)	Min Frequency	Max Frequency	Cap (nF)	WVDC (85C)	WVDC (105C)	WVDC (125C)	Finish
0201	160kHz	70GHz	10	10	10	6.3	Tin/Gold

[Click here to return to main table](#)

PERFORMANCE DATA

Series Insertion Loss (S21)

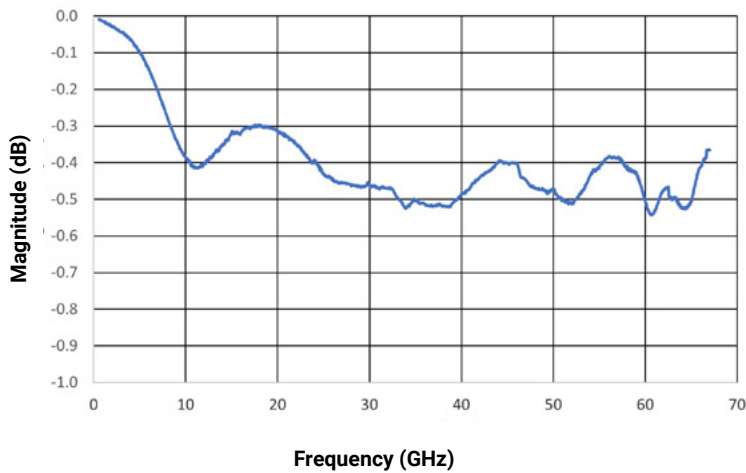

Series Return Loss (S11)

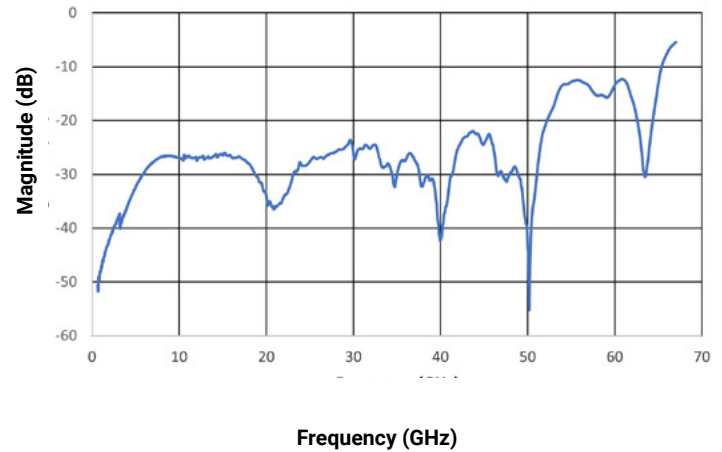

550Z Data Sheet Test Condition Description

All testing performed on 10 mil-thick rogers RO3006 microstrip board, with the device under test subtending a 10 mil gap in a 14.2 mil-wide center trace (nominal 50 ohms characteristic impedance).

560L104Y

Size (EIA)	Min Frequency	Max Frequency	Cap (nF)	WVDC (85C)	WVDC (105C)	WVDC (125C)	Finish
0402	16kHz	40 GHz	100	16	16	16	Tin/Gold

[Click here to return to main table](#)

PERFORMANCE DATA

AVX 560L Series Insertion Loss (S21)

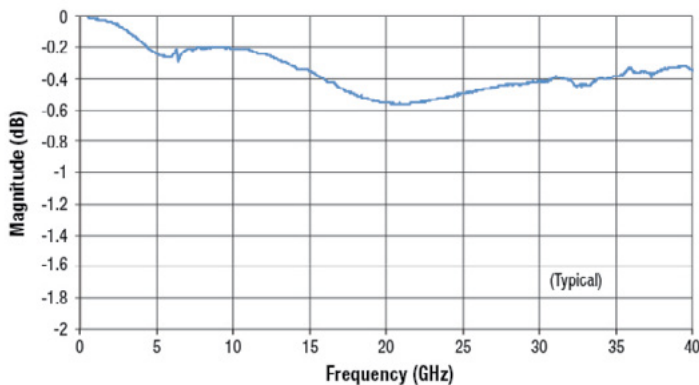

AVX 560L Series Return Loss (S11)

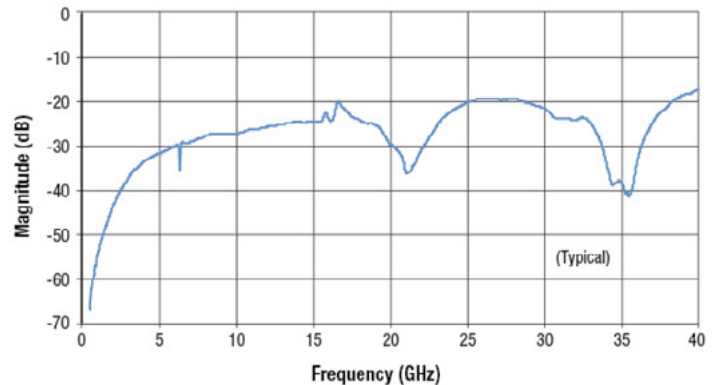

560L Data Sheet Test Condition Description

All testing performed on 10 mil-thick rogers RO4350B microstrip board, with the device under test subtending a 24 mil gap in a 22 mil-wide center trace (nominal 50 ohms characteristic impedance).

RF/Microwave Capacitors
RF/Microwave Multilayer Capacitors (MLC)
550-560 Series UBC™ Ultra-Broadband Capacitor



550L104K

Size (EIA)	Min Frequency	Max Frequency	Cap (nF)	WVDC (85C)	WVDC (105C)	WVDC (125C)	Finish
0402	16kHz	70GHz	100	16	16	16	Tin/Gold

[Click here to return to main table](#)

PERFORMANCE DATA

550L Series Insertion Loss (S21)

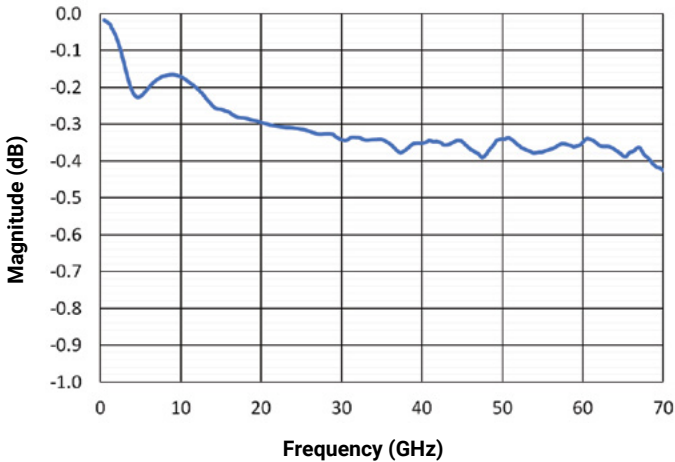

550L Series Return Loss (S11)

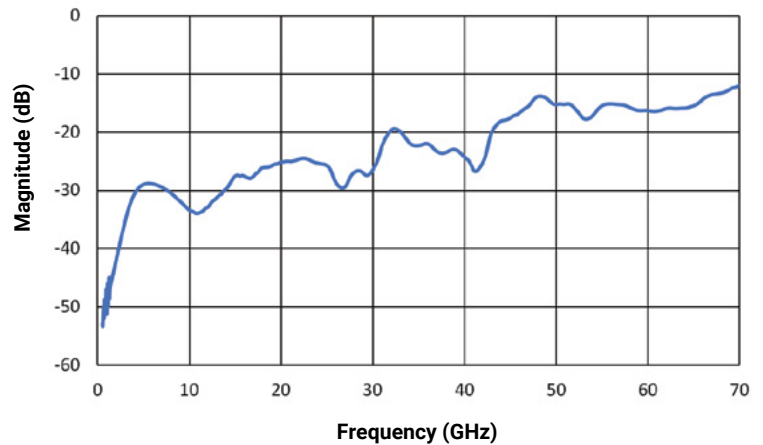

550L Data Sheet Condition Description

All testing performed on 10 mil-thick rogers R04350B microstrip board, with the device under test subtending a 24 mil gap in a 22 mil-wide center trace (nominal 50 ohms characteristic impedance).

SIMULATION MODELS



KYOCERA AVX and Modelithics have partnered to offer FREE 90-Day trials of highly accurate, scalable advanced simulation models for various KYOCERA AVX parts including **THIS** part as well as Attenuators, Capacitors, Couplers, Inductors, Diplexers, Resistors.

For More Information, Please Visit: <https://www.modelithics.com/mvp/avx>
 Use Promo Code: AVXWP

RF/Microwave Capacitors

RF/Microwave Multilayer Capacitors (MLC)

600L Ultra-Low ESR NPO Capacitors

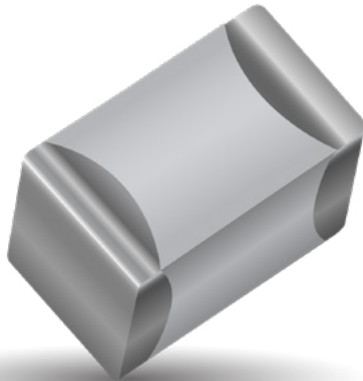

FEATURES

- Lowest ESR in Class
- Highest Working Voltage in Class - 200 V
- Capacitance Range 0.1 pF to 27 pF
- High Q
- High Self-Resonance

600 SERIES OVERVIEW

Series	Case Size	EIA Case Size
600	L	0402
600	S	0603
600	F	0805

APPLICATIONS

- Cellular Base Stations
- Broadband Wireless Services
- Satellite Communications
- Subscriber-based Wireless Devices
- WiFi (802.11)
- Public Safety Radio

CIRCUIT APPLICATIONS

- Filter Networks
- High Q Frequency Sources
- Matching Networks
- Tuning, Coupling, Bypass and DC Blocking

ELECTRICAL SPECIFICATIONS

Temperature Coefficient (TCC)	0 ± 30 PPM/°C
Capacitance Range	0.1 pF to 27 pF
Operating Temperature	-55°C to +125°C*
Quality Factor	Greater than 2,000 at 1 MHz
Insulation Resistance (IR)	10 ⁵ Megohms min. @ 25°C at rated WVDC 10 ⁴ Megohms min. @ 125°C at rated WVDC
Working Voltage (WVDC)	200 V
Dielectric Withstanding Voltage (DWV)	250% of rated WVDC for 5 seconds
Aging Effects	None
Piezoelectric Effects	None

PACKAGING OPTIONS



Tape & Reel



ENVIRONMENTAL CHARACTERISTICS

Thermal Shock	5 Cycles, -55°C to 125°C
Moisture Resistance	Mil-STD-202, Method 106
Life Test	2000 hours at 125°C at 2X
Solderability	Solder Coverage > 90% of end termination
Terminal Strength	2 lbs. typ., 1 lb. min.
Military Approval	DSCC Drawing Number 05003

RF/Microwave Capacitors

RF/Microwave Multilayer Capacitors (MLC)

600L Ultra-Low ESR NPO Capacitors



CAPACITANCE VALUES

Value (pF)	Cap Code	Tolerances	Value (pF)	Cap Code	Tolerances	Value (pF)	Cap Code	Tolerances
0.1	0R1	A, B	1.6	1R6	A, B, C, D	6.2	6R2	A, B, C, D
0.2	0R2	A, B	1.8	1R8	A, B, C, D	6.8	6R8	B, C, J, K
0.3	0R3	A, B, C	2.0	2R0	A, B, C, D	7.5	7R5	B, C, J, K
0.4	0R4	A, B, C	2.2	2R2	A, B, C, D	8.2	8R2	B, C, J, K
0.5	0R5	A, B, C	2.4	2R4	A, B, C, D	9.1	9R1	B, C, J, K
0.6	0R6	A, B, C	2.7	2R7	A, B, C, D	10	100	F, G, J, K, M
0.7	0R7	A, B, C	3.0	3R0	A, B, C, D	11	110	F, G, J, K, M
0.8	0R8	A, B, C	3.3	3R3	A, B, C, D	12	120	F, G, J, K, M
0.9	0R9	A, B, C	3.6	3R6	A, B, C, D	15	150	F, G, J, K, M
1.0	1R0	A, B, C, D	3.9	3R9	A, B, C, D	18	180	F, G, J, K, M
1.1	1R1	A, B, C, D	4.3	4R3	A, B, C, D	20	200	F, G, J, K, M
1.2	1R2	A, B, C, D	4.7	4R7	A, B, C, D	22	220	F, G, J, K, M
1.3	1R3	A, B, C, D	5.1	5R1	A, B, C, D	24	240	F, G, J, K, M
1.5	1R5	A, B, C, D	5.6	5R6	A, B, C, D	27	270	F, G, J, K, M

HOW TO ORDER

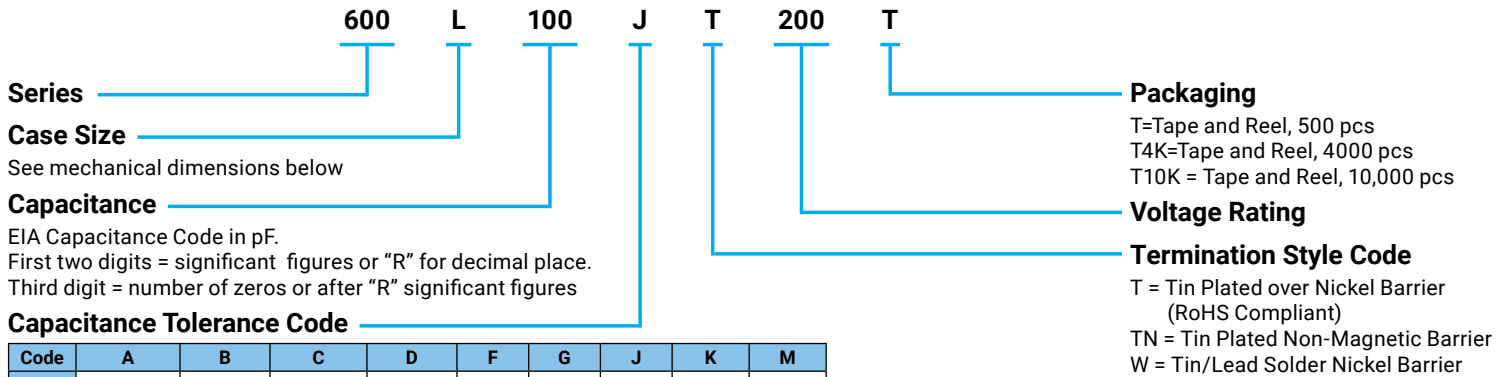

*All Tape and Reel Packaging comes on 7" reels. The above part number refers to a 600L Series (case size L) 11 pF capacitor, J tolerance (±5%), 200 WVDC, with T termination (Tin Plated over Nickel Barrier, RoHS Compliant), Tape and Reel packaging.

600L ESR vs. Frequency

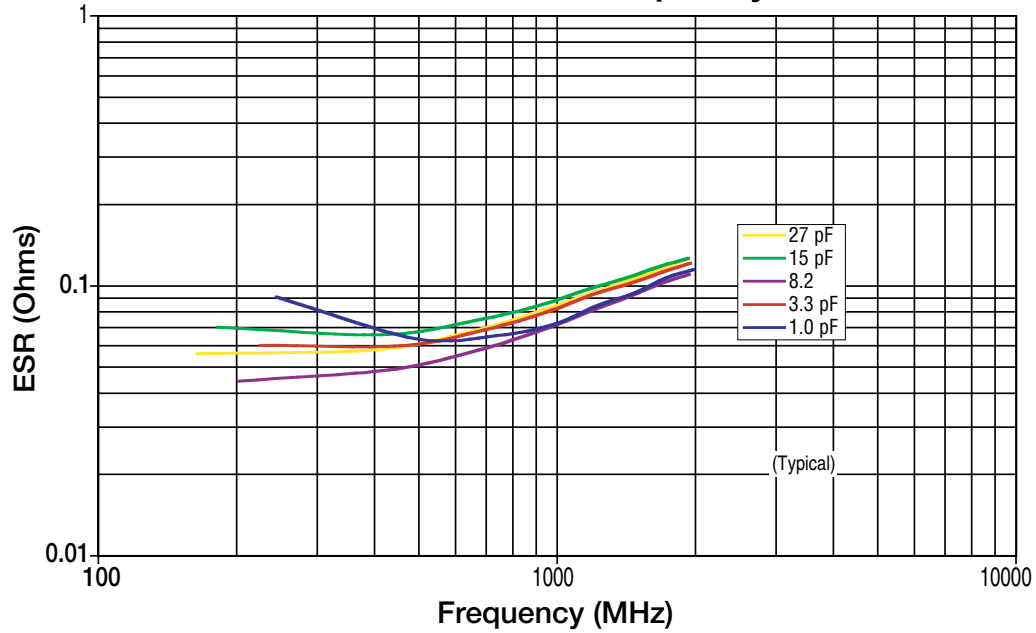

600L Resonant Frequency Data

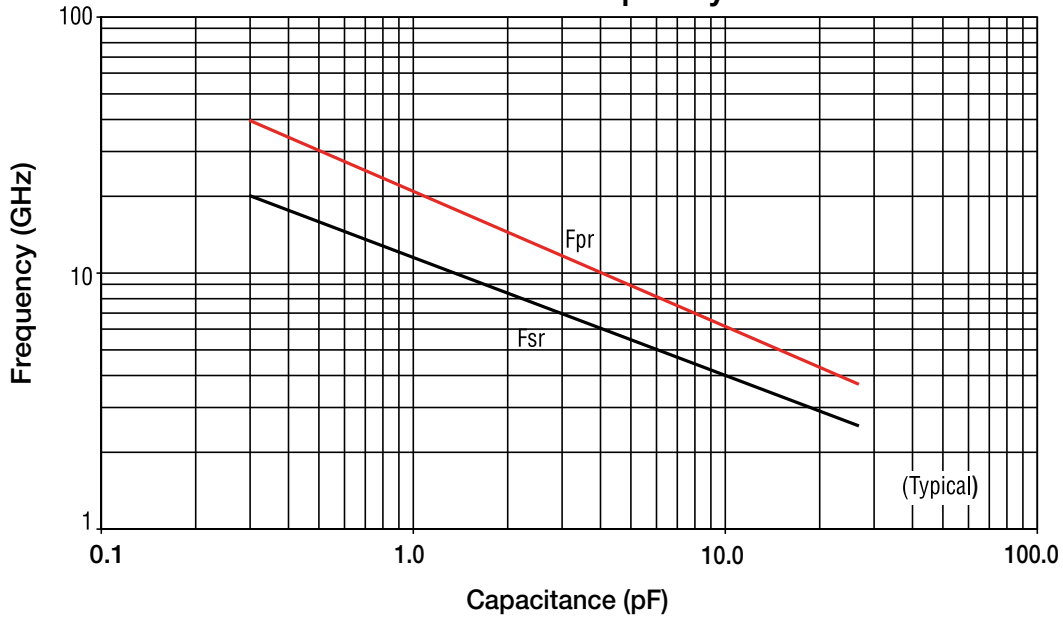

ATC 600L Series Data Sheet Test Condition Description

Capacitors mounted in series microstrip configuration on 10-mil thick Rogers R04350® softboard, 22-mils wide 1/2 oz. Cu traces.

FSR = lowest frequency at which S11 response, referenced at capacitor edge, crosses real axis on Smith Chart.

FPR = lowest frequency at which there is a notch in S21 magnitude response.

RF/Microwave Capacitors
RF/Microwave Multilayer Capacitors (MLC)
600L Ultra-Low ESR NPO Capacitors



OUTLINE DIMENSIONS

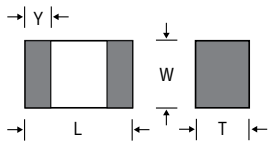

L (0402)	L: $.040 \pm .004$ (1.02 \pm 0.1)	T: .024 max (0.60 max)
	W: $.020 \pm .004$ (.51 \pm 0.1)	Y: $.010 \pm .006$ (0.25 \pm 0.15)

inches (mm)

SUGGESTED MOUNTING PAD DIMENSIONS

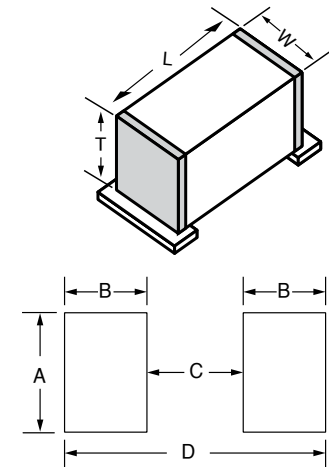

Case Size L, S, and F

Case Size	A Min.	B Min.	C Min.	D Min.
0402 (1005)	.0275 (0.70)	.0354 (0.90)	.0157 (0.40)	.0866 (2.20)
0603 (1608)	.0393 (1.00)	.0433 (1.10)	.0236 (0.60)	.110 (2.80)
0805 (2012)	.0590 (1.50)	.0512 (1.30)	.0236 (0.60)	.1259 (3.20)

inches (mm)

DESIGN KITS

Kit #	RoHS Compliant	Item #	Description	Cap. Value Range (pF)	Cap. Value (pF)	Tol. (pF)	Price
Kit 36T		DK0036T	600L Series Ultra-low ESR, High Q Microwave Capacitors 16 different values, 15 pcs. min. per value	0.1 to 2.0	0.1, 0.2, 0.3, 0.4, 0.5, 0.6, 0.7, 0.8, 0.9, 1.0, 1.1, 1.2, 1.5.....	± 0.1	\$100.00
					1.6, 1.8, 2.0		
Kit 37T		DK0037T	600L Series Ultra-low ESR, High Q Microwave Capacitors 16 different values, 15 pcs. min. per value	0.1 to 10	1.0, 1.2, 1.5, 1.8, 2.0, 2.2, 2.4, 2.7, 3.0, 3.3	± 0.1	\$100.00
					3.9, 4.7, 5.6, 6.8, 8.2		
					10	$\pm 5\%$	
Kit 38T		DK0038T	600L Series Ultra-low ESR, High Q Microwave Capacitors 8 different values, 15 pcs. min. per value	10 to 27	10, 12, 15, 18, 20, 22, 24, 27	$\pm 5\%$	\$100.00

For Online Kit Orders, Catalog & Application Notes, Visit: www.avx.com

RF/Microwave Capacitors

RF/Microwave Multilayer Capacitors (MLC)

600F Ultra-Low ESR, High Q, NPO Capacitors

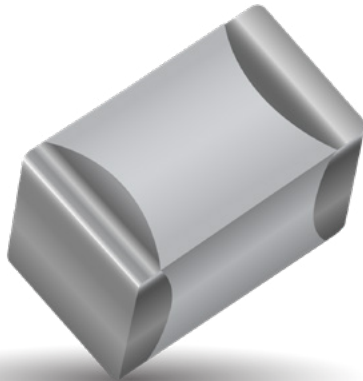

FEATURES

- Lowest ESR in Class
- Highest Working Voltage in Class - 250 V
- Standard EIA Size: 0805
- Laser Marking (Optional)
- High Self-Resonance Frequencies

600 SERIES OVERVIEW

Series	Case Size	EIA Case Size
600	L	0402
600	S	0603
600	F	0805

APPLICATIONS

- Cellular Base Stations
- Broadband Wireless Services
- Satellite Communications
- Subscriber-based Wireless Devices
- WiFi (802.11)
- Public Safety Radio

CIRCUIT APPLICATIONS

- Filter Networks
- High Q Frequency Sources
- Matching Networks
- Tuning, Coupling, Bypass and DC Blocking

ELECTRICAL SPECIFICATIONS

Temperature Coefficient (TCC)	0 ± 30 PPM/°C
Capacitance Range	0.1 pF to 240 pF
Operating Temperature	-55°C to +125°C*
Quality Factor	Greater than 2,000 @ 1 MHz
Insulation Resistance (IR)	10 ⁵ Megohms min. @ 25°C at rated WVDC 10 ⁴ Megohms min. @ 125°C at rated WVDC
Working Voltage (WVDC)	250 V
Dielectric Withstanding Voltage (DWV)	250% of rated WVDC for 5 seconds
Aging Effects	None
Piezoelectric Effects	None

PACKAGING OPTIONS



Tape & Reel



Vertical Orientation Tape & Reel



ENVIRONMENTAL CHARACTERISTICS

Thermal Shock	5 Cycles, -55°C to 125°C
Moisture Resistance	Mil-STD-202, Method 106
Life Test	2000 hours at 125°C at 2X WVDC
Solderability	Solder Coverage > 90% of end termination
Terminal Strength	4 lbs. typ., 2 lb. min.
Military Approval	DSCC Drawing Number 05001

RF/Microwave Capacitors

RF/Microwave Multilayer Capacitors (MLC)

600F Ultra-Low ESR, High Q, NPO Capacitors



CAPACITANCE VALUES

Value (pF)	Cap Code	Marking	Tolerances	Value (pF)	Cap Code	Marking	Tolerances	Value (pF)	Cap Code	Marking	Tolerances
0.1	0R1	A9	A, B	3.3	3R3	N0	A, B, C, D	30	300	M1	F, G, J, K, M
0.2	0R2	H9	A, B	3.6	3R6	P0	A, B, C, D	33	330	N1	F, G, J, K, M
0.3	0R3	M9	A, B, C	3.9	3R9	Q0	A, B, C, D	36	360	P1	F, G, J, K, M
0.4	0R4	d9	A, B, C	4.3	4R3	R0	A, B, C, D	39	390	Q1	F, G, J, K, M
0.5	0R5	f9	A, B, C	4.7	4R7	S0	A, B, C, D	43	430	R1	F, G, J, K, M
0.6	0R6	m9	A, B, C	5.1	5R1	T0	A, B, C, D	47	470	S1	F, G, J, K, M
0.7	0R7	n9	A, B, C	5.6	5R6	U0	A, B, C, D	51	510	T1	F, G, J, K, M
0.8	0R8	t9	A, B, C	6.2	6R2	V0	A, B, C, D	56	560	U1	F, G, J, K, M
0.9	0R9	y9	A, B, C	6.8	6R8	W0	B, C, J, K	62	620	V1	F, G, J, K, M
1.0	1R0	A0	A, B, C, D	7.5	7R5	X0	B, C, J, K	68	680	W1	F, G, J, K, M
1.1	1R1	B0	A, B, C, D	8.2	8R2	Y0	B, C, J, K	75	750	X1	F, G, J, K, M
1.2	1R2	C0	A, B, C, D	9.1	9R1	Z0	B, C, J, K	82	820	Y1	F, G, J, K, M
1.3	1R3	D0	A, B, C, D	10	100	A1	F, G, J, K, M	91	910	Z1	F, G, J, K, M
1.5	1R5	E0	A, B, C, D	11	110	B1	F, G, J, K, M	100	101	A2	F, G, J, K, M
1.6	1R6	F0	A, B, C, D	12	120	C1	F, G, J, K, M	110	111	B2	F, G, J, K, M
1.8	1R8	G0	A, B, C, D	15	150	E1	F, G, J, K, M	120	121	C2	F, G, J, K, M
2.0	2R0	H0	A, B, C, D	18	180	G1	F, G, J, K, M	150	151	E2	F, G, J, K, M
2.2	2R2	J0	A, B, C, D	20	200	H1	F, G, J, K, M	180	181	G2	F, G, J, K, M
2.4	2R4	K0	A, B, C, D	22	220	J1	F, G, J, K, M	200	201	H2	F, G, J, K, M
2.7	2R7	L0	A, B, C, D	24	240	K1	F, G, J, K, M	220	221	J2	F, G, J, K, M
3.0	3R0	M0	A, B, C, D	27	270	L1	F, G, J, K, M	240	241	K2	F, G, J, K, M

HOW TO ORDER

Series 600
Case Size F
 See mechanical dimensions below
Capacitance Code 100
 EIA Capacitance Code in pF.
 Third digit = number of zeros or after "R" significant figures
Capacitance Tolerance Code J

Code	A	B	C	D	F	G	J	K	M
Tol.	±0.05 pF	±0.1 pF	±0.25 pF	±0.5 pF	±1%	±2%	±5%	±10%	±20%

 The above part number refers to a 600F Series (case size F) 10 pF capacitor, J tolerance (±5%), 250 WVDC, with T termination (Tin Plated over Nickel Barrier, RoHS Compliant), Laser Marking and Tape and Reel packaging.

Termination Style Code T
 T = Tin Plated over Nickel Barrier (RoHS Compliant)
 TN = Tin Plated Non-Magnetic Barrier
 W = Tin/Lead Solder Nickel Barrier

Voltage Rating 250
Laser Marking (Optional) X**
Packaging T
 T = Tape and Reel, 500 pcs
 T4K = Tape and Reel, 4000 pcs
 TV = Vertical Tape and Reel, 500 pcs

**Laser Marking is optional

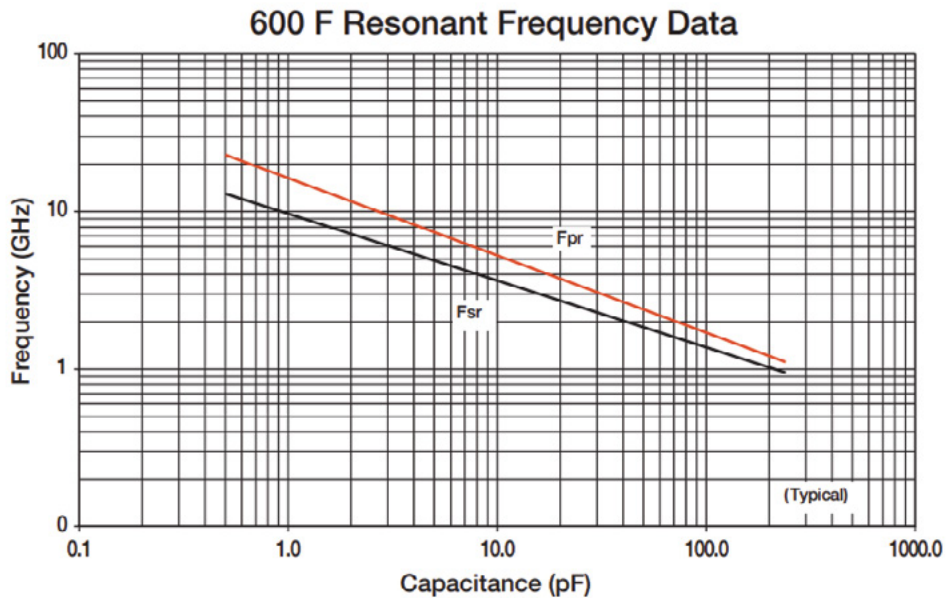
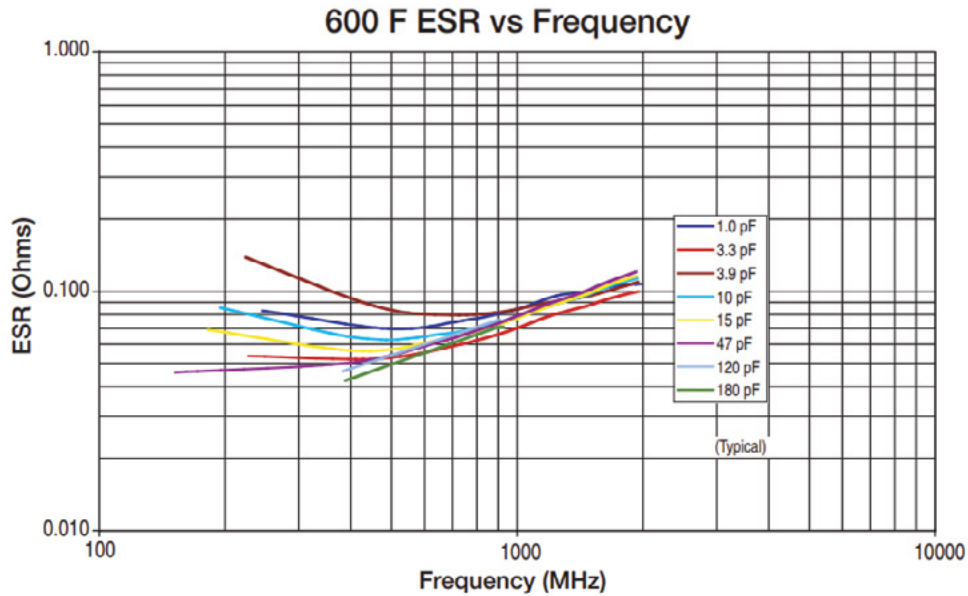

600F Series Data Sheet Condition Description

Capacitors horizontally mounted on 23.3-mil thick Rogers R0435® softboard 52-mils wide 1/2 oz. Cu traces
FSR = lowest frequency at which S11 response, referenced at capacitor edge, crosses real axis on Smith Chart.
FPR = lowest frequency at which there is a notch in S21 magnitude response.

RF/Microwave Capacitors

RF/Microwave Multilayer Capacitors (MLC)

600F Ultra-Low ESR, High Q, NPO Capacitors



OUTLINE DIMENSIONS

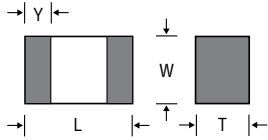

L (0805)	L: $.079 \pm .008$ (2.01 \pm 0.20)	T: $.051$ max (1.30 max)
	W: $.049 \pm .008$ (1.24 \pm 0.20)	Y: $.020 \pm 0.01$ (0.51 \pm 0.25)

inches (mm)

SUGGESTED MOUNTING PAD DIMENSIONS

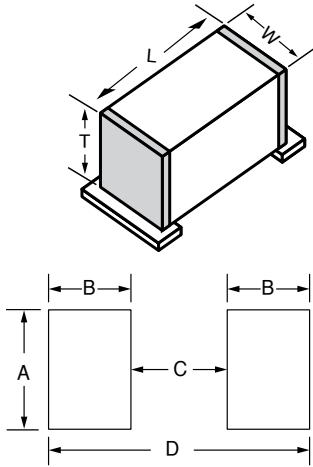

Case Size L, S, and F

Case Size	A Min.	B Min.	C Min.	D Min.
0402 (1005)	.0275 (0.70)	.0354 (0.90)	.0157 (0.40)	.0866 (2.20)
0603 (1608)	.0393 (1.00)	.0433 (1.10)	.0236 (0.60)	.110 (2.80)
0805 (2012)	.0590 (1.50)	.0512 (1.30)	.0236 (0.60)	.1259 (3.20)

inches (mm)

DESIGN KITS

Kit #	RoHS Compliant	Item #	Description	Cap. Value Range (pF)	Cap. Value (pF)	Tol. (pF)	Price
Kit 32T		DK0032T	600F Series Ultra-low ESR, High Q Microwave Capacitors 16 different values, 15 pcs. min. per value	0.1 to 2.0	0.1, 0.2, 0.3, 0.4, 0.5, 0.6, 0.7, 0.8, 0.9, 1.0, 1.1, 1.2, 1.5 $\pm 0.1\%$ 1.6, 1.8, 2.0 $\pm 0.25\%$		\$100.00
Kit 33T		DK0033T	600F Series Ultra-low ESR, High Q Microwave Capacitors 16 different values, 15 pcs. min. per value	0.1 to 10	1.0, 1.2, 1.5, 1.8, 2.0, 2.2, 2.4, 2.7, 3.0, 3.3 $\pm 0.1\%$ 3.9, 4.7, 5.6, 6.8, 8.2 $\pm 0.25\%$ 10 $\pm 5\%$		\$100.00
Kit 34T		DK0034T	600F Series Ultra-low ESR, High Q Microwave Capacitors 16 different values, 15 pcs. min. per value	10 to 27	10, 12, 15, 18, 20, 22, 24, 27 $\pm 5\%$		\$100.00
Kit 35T		DK0035T	600F Series Ultra-low ESR, High Q Microwave Capacitors 7 different values, 15 pcs. min. per value	100 to 240	100, 120, 150, 180, 200, 220, 240 $\pm 5\%$		\$55.00

For Online Kit Orders, Catalog & Application Notes, Visit: www.avx.com

RF/Microwave Capacitors

RF/Microwave Multilayer Capacitors (MLC)

600S Ultra-Low ESR, High Q, NPO Capacitors

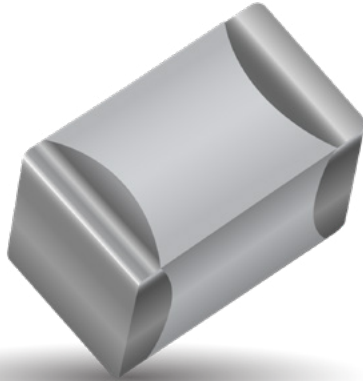

FEATURES

- Lowest ESR in Class
- Highest Working Voltage in Class - 250 V
- Standard EIA Size: 0603
- Laser Marking (Optional)
- High Self-Resonance Frequencies

600 SERIES OVERVIEW

Series	Case Size	EIA Case Size
600	L	0402
600	S	0603
600	F	0805

APPLICATIONS

- Cellular Base Stations
- Broadband Wireless Services
- Satellite Communications
- Subscriber-based Wireless Devices
- WiFi (802.11)
- Public Safety Radio

CIRCUIT APPLICATIONS

- Filter Networks
- High Q Frequency Sources
- Matching Networks
- Tuning, Coupling, Bypass and DC Blocking

ELECTRICAL SPECIFICATIONS

Capacitance	0.1 to 100 pF
Tolerances	See Cap Value Chart
Working Voltage (WVDC)	250 V
Quality Factor (Q)	> 2000 @ 1 MHz
Operating Temperature Range	-55°C to +125°C (no derating of working voltage)
Temperature Coefficient of Capacitance (TCC)	0 ± 30 ppm/°C, -55°C to +125°C 10 ⁵ MΩ min. at +25°C at rated WVDC 10 ⁴ MΩ min. at +125°C at rated WVDC
Dielectric Withstanding Voltage (DWV)	2.5 x WVDC for 5 seconds
Aging	None
Piezo Effects	None

PACKAGING OPTIONS



Tape & Reel



Vertical Orientation Tape & Reel



ENVIRONMENTAL CHARACTERISTICS

Thermal Shock	5 Cycles, -55°C to 125°C
Moisture Resistance	Mil-STD-202, Method 106
Life Test	2000 hours at 125°C at 2X WVDC
Solderability	Solder Coverage > 90% of end termination
Terminal Strength	4 lbs. typ., 2 lb. min.
Military Approval	DSCC Drawing Number 05002

RF/Microwave Capacitors

RF/Microwave Multilayer Capacitors (MLC)

600S Ultra-Low ESR, High Q, NPO Capacitors



CAPACITANCE VALUES

Value (pF)	Cap Code	Marking	Tolerances	Value (pF)	Cap Code	Marking	Tolerances	Value (pF)	Cap Code	Marking	Tolerances
0.1	0R1	A9	A, B	2.7	2R7	L0	A, B, C, D	20	200	H1	F, G, J, K, M
0.2	0R2	H9	A, B	3.0	3R0	M0	A, B, C, D	22	220	J1	F, G, J, K, M
0.3	0R3	M9	A, B, C	3.3	3R3	N0	A, B, C, D	24	240	K1	F, G, J, K, M
0.4	0R4	d9	A, B, C	3.6	3R6	P0	A, B, C, D	27	270	L1	F, G, J, K, M
0.5	0R5	f9	A, B, C	3.9	3R9	Q0	A, B, C, D	30	300	M1	F, G, J, K, M
0.6	0R6	m9	A, B, C	4.3	4R3	R0	A, B, C, D	33	330	N1	F, G, J, K, M
0.7	0R7	n9	A, B, C	4.7	4R7	S0	A, B, C, D	36	360	P1	F, G, J, K, M
0.8	0R8	t9	A, B, C	5.1	5R1	T0	A, B, C, D	39	390	Q1	F, G, J, K, M
0.9	0R9	y9	A, B, C	5.6	5R6	U0	A, B, C, D	43	430	R1	F, G, J, K, M
1.0	1R0	A0	A, B, C, D	6.2	6R2	V0	A, B, C, D	47	470	S1	F, G, J, K, M
1.1	1R1	B0	A, B, C, D	6.8	6R8	W0	B, C, J, K	51	510	T1	F, G, J, K, M
1.2	1R2	C0	A, B, C, D	7.5	7R5	X0	B, C, J, K	56	560	U1	F, G, J, K, M
1.3	1R3	D0	A, B, C, D	8.2	8R2	Y0	B, C, J, K	62	620	V1	F, G, J, K, M
1.5	1R5	E0	A, B, C, D	9.1	9R1	Z0	B, C, J, K	68	680	W1	F, G, J, K, M
1.6	1R6	F0	A, B, C, D	10	100	A1	F, G, J, K, M	75	750	X1	F, G, J, K, M
1.8	1R8	G0	A, B, C, D	11	110	B1	F, G, J, K, M	82	820	Y1	F, G, J, K, M
2.0	2R0	H0	A, B, C, D	12	120	C1	F, G, J, K, M	91	910	Z1	F, G, J, K, M
2.2	2R2	J0	A, B, C, D	15	150	E1	F, G, J, K, M	100	101	A2	F, G, J, K, M
2.4	2R4	K0	A, B, C, D	18	180	G1	F, G, J, K, M				

HOW TO ORDER

600 **S** **0R2** **B** **T** **250** **X**** **T**

Series ————
Case Size ————
 See mechanical dimensions below
Capacitance Code ————
 EIA Capacitance Code in pF.
 Third digit = number of zeros or after "R" significant figures
Capacitance Tolerance Code ————

Packaging
 T = Tape and Reel, 500 pcs
 T4K = Tape and Reel, 4000 pcs
 TV = Vertical Tape and Reel, 500 pcs
Laser Marking (Optional)
Voltage Rating
Termination Style Code
 T = Tin Plated over Nickel Barrier (RoHS Compliant)
 TN = Tin Plated Non-Magnetic Barrier
 W = Tin/Lead Solder Nickel Barrier

Code	A	B	C	D	F	G	J	K	M
Tol.	±0.05 pF	±0.1 pF	±0.25 pF	±0.5 pF	±1%	±2%	±5%	±10%	±20%

The above part number refers to a 600F Series (case size F) 10 pF capacitor, J tolerance (±5%), 250 WVDC, with T termination (Tin Plated over Nickel Barrier, RoHS Compliant), Laser Marking and Tape and Reel packaging.

**Laser Marking is optional

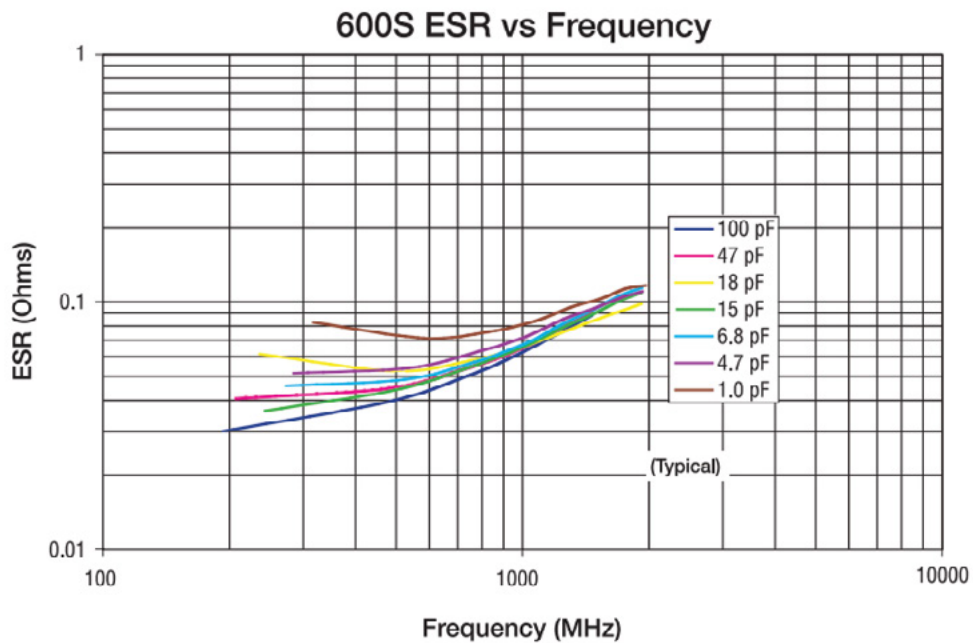
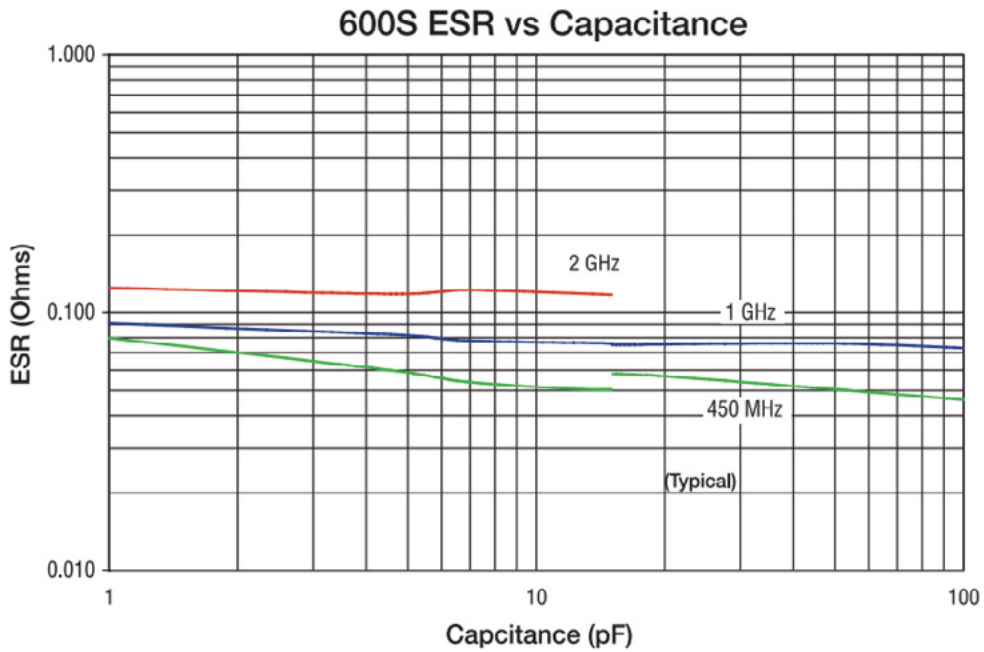

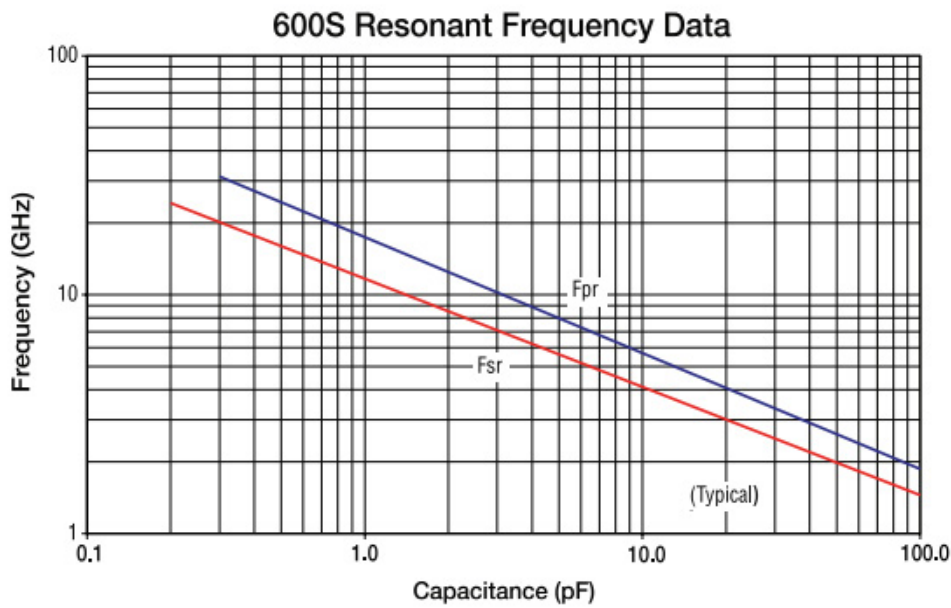
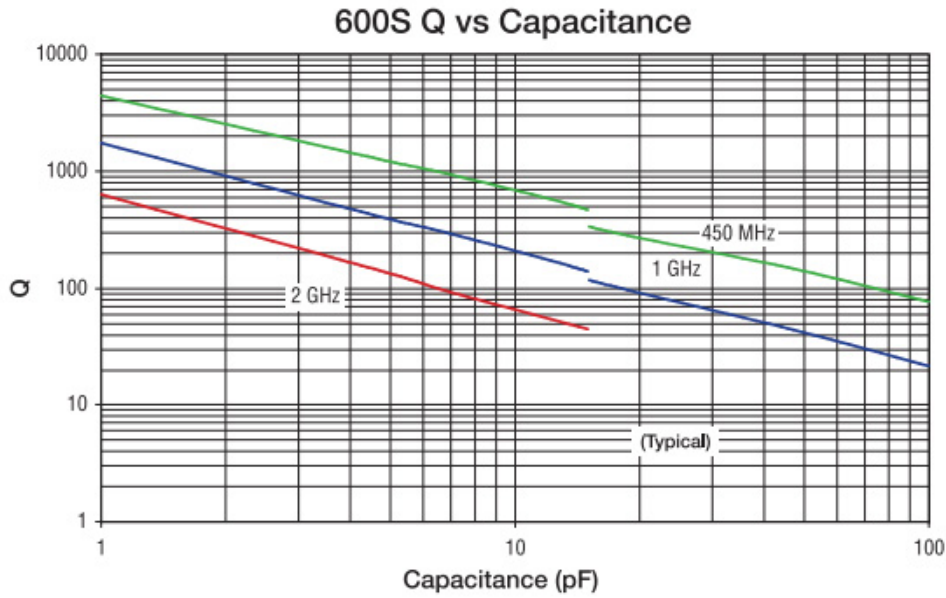

600F Series Data Sheet Condition Description

Capacitors horizontally mounted on 13.3-mil thick Rogers R0435® softboard 29-mils wide 1/2 oz. Cu traces
FSR = lowest frequency at which S11 response, referenced at capacitor edge, crosses real axis on Smith Chart.
FPR = lowest frequency at which there is a notch in S21 magnitude response.

RF/Microwave Capacitors
RF/Microwave Multilayer Capacitors (MLC)
600S Ultra-Low ESR, High Q, NPO Capacitors



OUTLINE DIMENSIONS

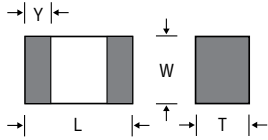

S (0603)	L: $.063 \pm .006$ (1.60 \pm 0.15)	T: $.035$ max (0.89 max)
	W: $.032 \pm .006$ (.81 \pm 0.15)	Y: $.014 \pm .006$ (0.36 \pm 0.15)

inches (mm)

SUGGESTED MOUNTING PAD DIMENSIONS

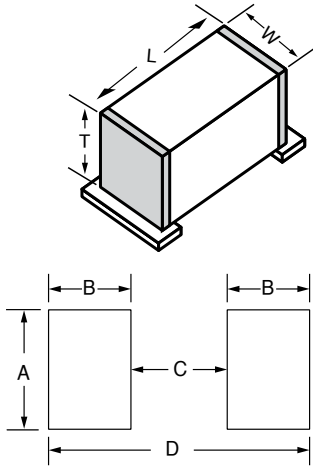

Case Size L, S, and F

Case Size	A Min.	B Min.	C Min.	D Min.
0402 (1005)	.0275 (0.70)	.0354 (0.90)	.0157 (0.40)	.0866 (2.20)
0603 (1608)	.0393 (1.00)	.0433 (1.10)	.0236 (0.60)	.110 (2.80)
0805 (2012)	.0590 (1.50)	.0512 (1.30)	.0236 (0.60)	.1259 (3.20)

inches (mm)

DESIGN KITS

Kit #	RoHS Compliant	Item #	Description	Cap. Value Range (pF)	Cap. Value (pF)	Tol. (pF)	Price
Kit 25T		DK0025T	600S Series Ultra-low ESR, High Q Microwave Capacitors 16 different values, 15 pcs. min. per value	0.1 to 2.0	0.1, 0.2, 0.3, 0.4, 0.5, 0.6, 0.7, 0.8, 0.9, 1.0, 1.1, 1.2, 1.5 \pm 0.1% 1.6, 1.8, 2.0 \pm 0.25%		\$100.00
Kit 26T		DK0026T	600S Series Ultra-low ESR, High Q Microwave Capacitors 16 different values, 15 pcs. min. per value	0.1 to 10	1.0, 1.2, 1.5, 1.8, 2.0, 2.2, 2.4, 2.7, 3.0, 3.3 \pm 0.1% 3.9, 4.7, 5.6, 6.8, 8.2 \pm 0.25% 10 \pm 5%		\$100.00
Kit 27T		DK0027T	600S Series Ultra-low ESR, High Q Microwave Capacitors 16 different values, 15 pcs. min. per value	10 to 100	10, 12, 15, 18, 20, 22, 24, 27, 30, 33, 39, 47 56, 68, 82, 100 \pm 5%		\$100.00

For Online Kit Orders, Catalog & Application Notes, Visit: www.avx.com

RF/Microwave Capacitors

RF/Microwave Multilayer Capacitors (MLC)

700A Series NP0 Porcelain and Ceramic Multilayer Capacitors

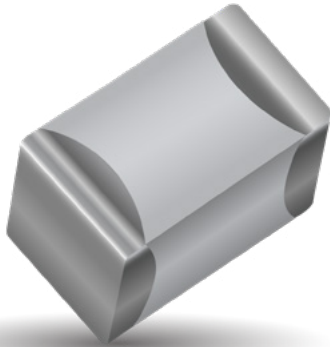

FEATURES

- Case A Size (.055" x .055")
- Low ESR / ESL
- High Q
- Low Noise
- Capacitance Range 0.1 pF to 1000 pF
- Extended WVDC up to 250 VDC
- Zero TCC
- High Self-Resonance
- Established Reliability (QPL)

GENERAL DESCRIPTION

KYOCERA AVX, the industry leader, offers new improved ESR/ESL performance for the 700 A Series RF/Microwave Capacitors. The superior high self-resonance and zero TCC characteristic of this Series provide excellent performance over a broad range of RF and microwave applications requiring minimum drift. High density porcelain and ceramic constructions provide a rugged, hermetic package.

Typical functional applications: Bypass, Coupling, Tuning and DC Blocking.

Typical circuit applications: Filters, Oscillators and Timing

PACKAGING OPTIONS



Tape & Reel



Vertical
Orientation
Tape & Reel



Cap-Pak®
(100 pcs)



ELECTRICAL SPECIFICATIONS

Temperature Coefficient (TCC)	0 ± 30 PPM/°C
Capacitance Range	0.1 pF to 1000 pF
Operating Temperature	-55°C to +125°C*
Quality Factor	Greater than 10,000 (0.1 pF to 100 pF) @ 1 MHz. Greater than 2000 (110 pF to 1000 pF) @ 1 MHz.
Insulation Resistance (IR)	0.1 pF to 470 pF 10 ⁶ Megohms min. @ 25°C at rated WVDC 10 ⁵ Megohms min. @ 125°C at rated WVDC 510 pF to 1000 pF 10 ⁵ Megohms min. @ 25°C at rated WVDC 10 ⁴ Megohms min. @ 125°C at rated WVDC
Working Voltage (WVDC)	See Capacitance Values table
Dielectric Withstanding Voltage (DWV)	250% of rated WVDC for 5 seconds
Aging Effects	None
Piezoelectric Effects	None
Capacitance Drift	± (0.02% or 0.02 pF), whichever is greater

ENVIRONMENTAL CHARACTERISTICS

Thermal Shock	Mil-STD-202, Method 107, Condition A
Moisture Resistance	Mil-STD-202, Method 106
Low Voltage Humidity	Mil-STD-202, Method 103, condition A, with 1.5 VDC applied while subjected to an environment of 85°C with 85% relative humidity for 240 hours
Life Test	MIL-STD-202, Method 108, for 2000 hours, at 125°C. 200% WVDC applied.
Solderability	Mil-STD-202, Method 208
Terminal Strength	Terminations for chips and pellets withstand a pull of 5 lbs. min., 10 lbs. typical, for 5 seconds in direction perpendicular to the termination surface of the capacitor.

RF/Microwave Capacitors

RF/Microwave Multilayer Capacitors (MLC)

700A Series NP0 Porcelain and Ceramic Multilayer Capacitors



CAPACITANCE VALUES

Cap. Code	Cap. (pF)	Tol.	Rated WVDC		Cap. Code	Cap. (pF)	Tol.	Rated WVDC		Cap. Code	Cap. (pF)	Tol.	Rated WVDC		Cap. Code	Cap. (pF)	Tol.	Rated WVDC	
			STD.	EXT.				STD.	EXT.				STD.	EXT.				STD.	EXT.
0R1	0.1	B	150	250	2R4	2.4	B, C, D	150	250	200	20	F, G, J, K, M	150	VOLTAGE	151	150	F, G, J, K, M	150	N/A
0R2	0.2				2R7	2.7				220	22				161	160			
0R3	0.3	B, C			3R0	3.0				240	24				181	180			
0R4	0.4				3R3	3.3				270	27				201	200			
0R5	0.5	B, C, D			3R6	3.6				300	30				221	220			
0R6	0.6				3R9	3.9				330	33				241	240			
0R7	0.7				4R3	4.3				360	36				271	270			
0R8	0.8				4R7	4.7				390	39				301	300			
0R9	0.9				5R1	5.1				430	43				331	330			
1R0	1.0				5R6	5.6				470	47				361	360			
1R1	1.1		B, C, D	6R2	6.2	510	51	391	390										
1R2	1.2			6R8	6.8	560	56	431	430										
1R3	1.3			7R5	7.5	620	62	471	470										
1R4	1.4			8R2	8.2	680	68	511	510										
1R5	1.5	9R1		9.1	750	75	561	560											
1R6	1.6	F, G, J, K, M		100	10	820	82	621	620										
1R7	1.7			110	11	910	91	681	680										
1R8	1.8			120	12	101	100	751	750										
1R9	1.9			130	13	111	110	821	820										
2R0	2.0			150	15	121	120	911	910										
2R1	2.1		160	16	131	130	102	1000											
2R2	2.2		180	18															

$v_{rms} = 0.707 \times WVDC$

Special values, tolerances, higher WVDC and matching available. Please consult factory.

note: extended wvdc does not apply to cdr products.

Capacitance values in bold type indicate porcelain dielectric. All other capacitance values indicate ceramic dielectric.

All 700 A Capacitors are available laser marked with KYOCERA AVX identification, capacitance code and tolerance.

HOW TO ORDER

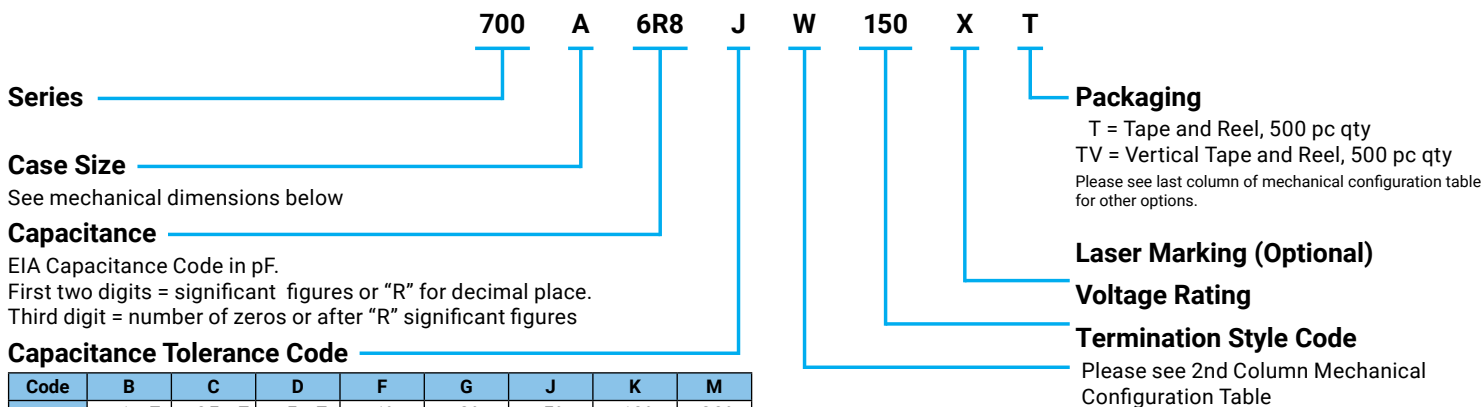

The above part number refers to a 700A Series (case size A) 6.8 pF capacitor, J tolerance (+/-5%), 150 WVDC, with W termination, (Tin/Lead, Solder Plated over Nickel Barrier), laser marking and Tape and Reel Packaging.

RF/Microwave Capacitors

RF/Microwave Multilayer Capacitors (MLC)

700A Series NP0 Porcelain and Ceramic Multilayer Capacitors



MECHANICAL CONFIGURATION

Series & Case Size	Term. Code	MIL-PRF-55681	Case Size & Type	Outline ES W/T is a Termination Surface	Body Dimensions inches (mm)			Lead and Termination Dimensions and Material			
					Length (L)	Width (W)	Thickness (T)	Overlap (Y)	Materials	Pkg Type	Pkg Code
700A	W	CDR12BP	A Solder Plate		.055+.015-.010 (1.40+0.38-0.25)	.055 ±.015 (1.40 ±0.38)	.057 (1.45) max.	.010+.010-.005 (0.25+0.25-.013)	Tin/ Lead, Solder Plated over Nickel Barrier Termination	T&R, 1000 or 500 pcs Vertical T&R, 1000 or 500 pcs Cap Pac, 100 pcs	T1K or T TV1K or TV C100
700A	P	CDR12BP	A Pellet		.055+.025-.010 (1.40+0.64-0.25)	.055 ±.015 (1.40 ±0.38)			Heavy Tin/ Lead Coated, over Nickel Barrier Termination	T&R, 1000 or 500 pcs Vertical T&R, 1000 or 500 pcs Cap Pac, 100 pcs	T1K or T TV1K or TV C100
700A	T	N/A	A Solderable Nickel Barrier		.055+.015-.010 (1.40+0.38-0.25)	.055 ±.015 (1.40 ±0.38)			RoHS Compliant Tin Plated over Nickel Barrier Termination	T&R, 1000 or 500 pcs Vertical T&R, 1000 or 500 pcs Cap Pac, 100 pcs	T1K or T TV1K or TV C100
700A	CA	CDR11BP	A Gold Chip		.055+.015-.010 (1.40+0.38-0.25)	.055 ±.015 (1.40 ±0.38)			RoHS Compliant Gold Plated over Nickel Barrier Termination	T&R, 1000 or 500 pcs Vertical T&R, 1000 or 500 pcs Cap Pac, 100 pcs	T1K or T TV1K or TV C100

NON-MAGNETIC CONFIGURATION

Series & Case Size	Term. Code	MIL-PRF-55681	Case Size & Type	Non-Magnetic Configuration	Body Dimensions inches (mm)			Lead and Termination Dimensions and Material			
					Length (L)	Width (W)	Thickness (T)	Overlap (Y)	Materials	Pkg Type	Pkg Code
700A	WN	Meets Requirements	A Non-Mag Solder Plate		.055+.025-.010 (1.40+0.64-0.25)	.055 ±.015 (1.40 ±0.38)	.057 (1.45) max.	.010+.010-.005 (0.25+0.25-.013)	Tin/ Lead, Solder Plated over Non-Magnetic Barrier Termination	T&R, 1000 or 500 pcs Vertical T&R, 1000 or 500 pcs Cap Pac, 100 pcs	T1K or T TV1K or TV C100
700A	PN	Meets Requirements	A Non-Mag Pellet		.055+.025-.010 (1.40+0.64-0.25)	.055 ±.015 (1.40 ±0.38)			Heavy Tin/ Lead Coated, over Non-Magnetic Barrier Termination	T&R, 1000 or 500 pcs Vertical T&R, 1000 or 500 pcs Cap Pac, 100 pcs	T1K or T TV1K or TV C100
700A	TN	Meets Requirements	A Non-Mag Solderable Barrier		.055+.015-.010 (1.40+0.38-0.25)	.055 ±.015 (1.40 ±0.38)			RoHS Compliant Tin Plated over Non-Magnetic Barrier Termination	T&R, 1000 or 500 pcs Vertical T&R, 1000 or 500 pcs Cap Pac, 100 pcs	T1K or T TV1K or TV C100

*Capacitors with values greater than 100 pF contain a trace magnetic element that may exhibit weak magnetic properties.

RF/Microwave Capacitors

RF/Microwave Multilayer Capacitors (MLC)

700A Series NP0 Porcelain and Ceramic Multilayer Capacitors



SUGGESTED MOUNTING PAD DIMENSIONS

Horizontal Electrode Orientation

Vertical Electrode Orientation

Case A					
Mount Type	Pad Size	A Min.	B Min.	C Min.	D Min.
Vertical Mount	Normal	.070	.050	.030	.130
	High Density	.050	.030	.030	.090
Horizontal Mount	Normal	.080	.050	.030	.130
	High Density	.060	.030	.030	.090

Dimensions are in inches.

PERFORMANCE DATA

**ESR VS. CAPACITANCE
SERIES 700, CASE A**

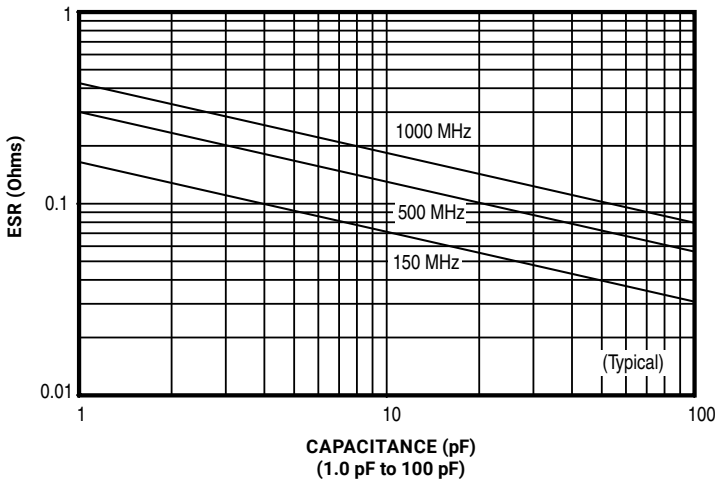

**Q VS. CAPACITANCE
SERIES 700, CASE A**

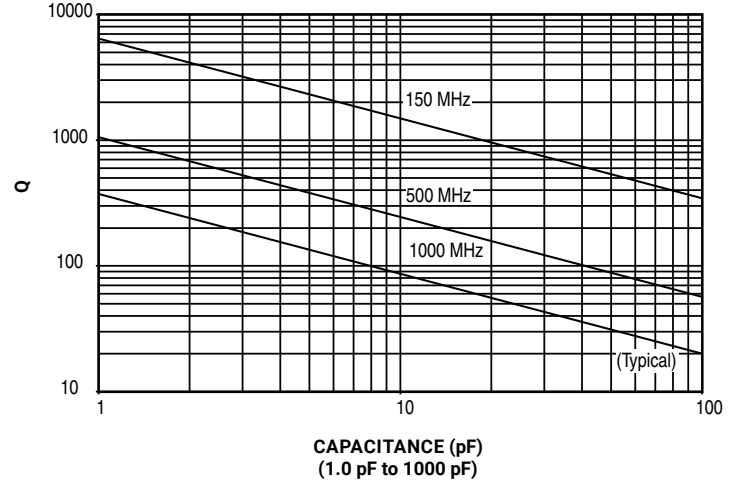

**ESR VS. CAPACITANCE
SERIES 700, CASE A**

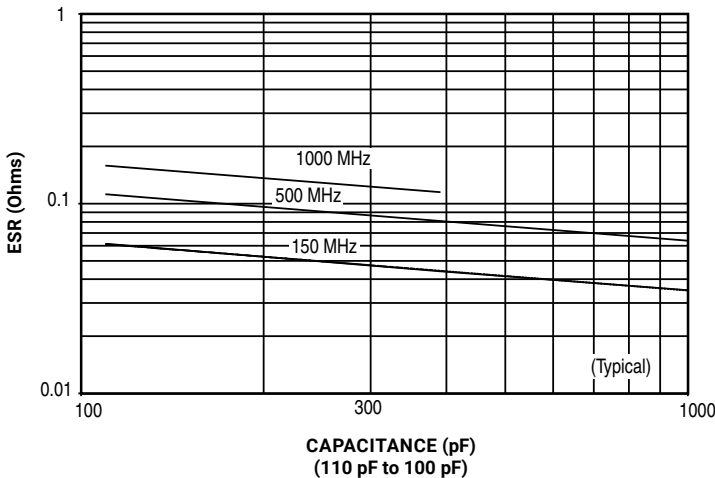

**Q VS. CAPACITANCE
SERIES 700, CASE A**

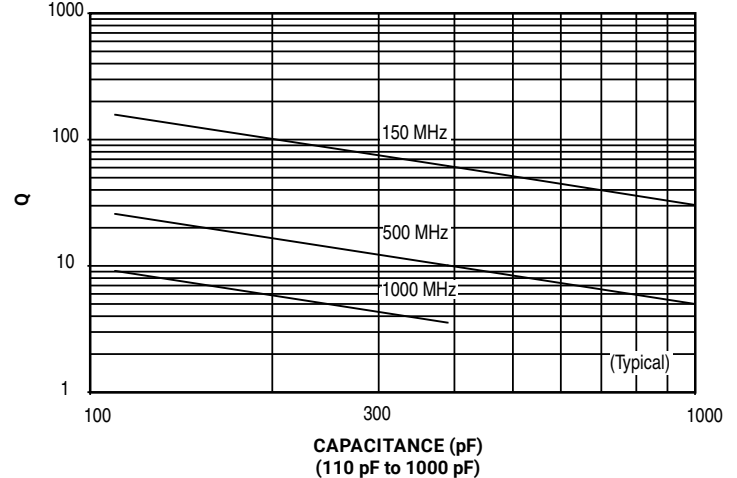

RF/Microwave Capacitors

RF/Microwave Multilayer Capacitors (MLC)

700A Series NP0 Porcelain and Ceramic Multilayer Capacitors



PERFORMANCE DATA

SERIES RESONANCE VS. CAPACITANCE
SERIES 700, CASE A

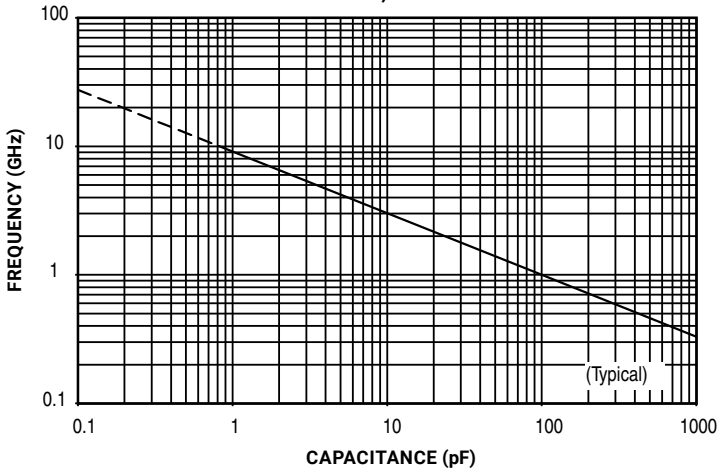

CAPACITANCE CHANGE VS. TEMPERATURE
SERIES 700, CASE A

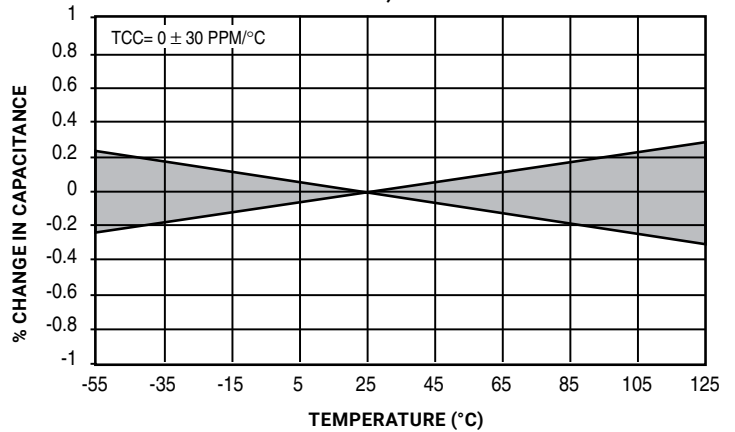

CURRENT RATING VS. CAPACITANCE
SERIES 700, CASE A

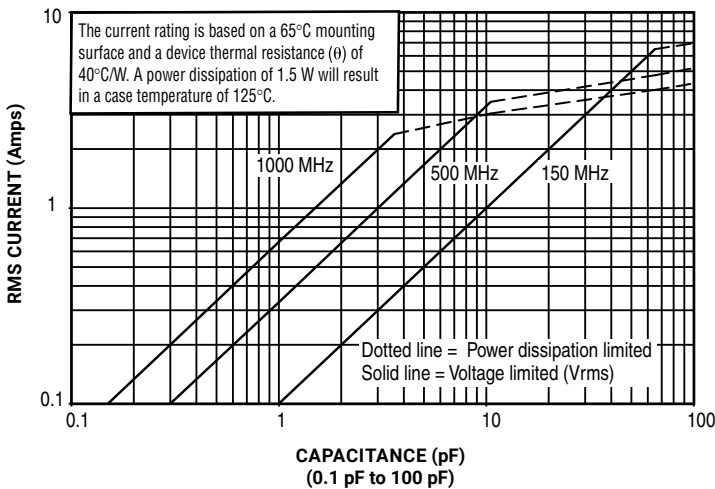

CURRENT RATING VS. CAPACITANCE
SERIES 700, CASE A

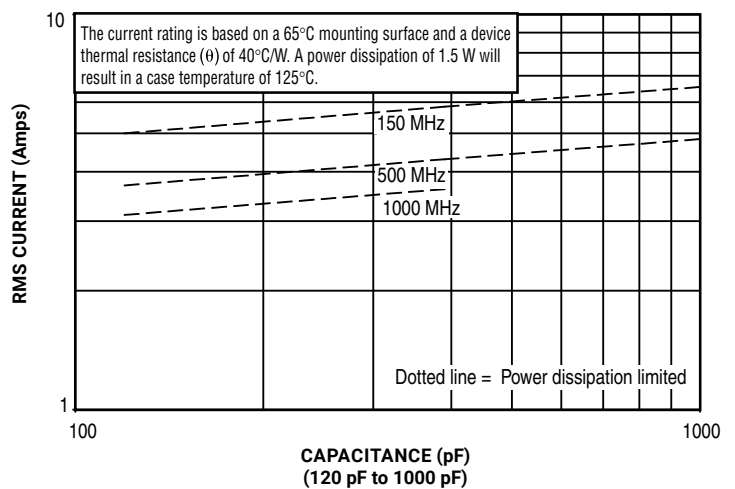

CURRENT RATING VS. CAPACITANCE
SERIES 700, CASE A, EXTENDED VOLTAGE

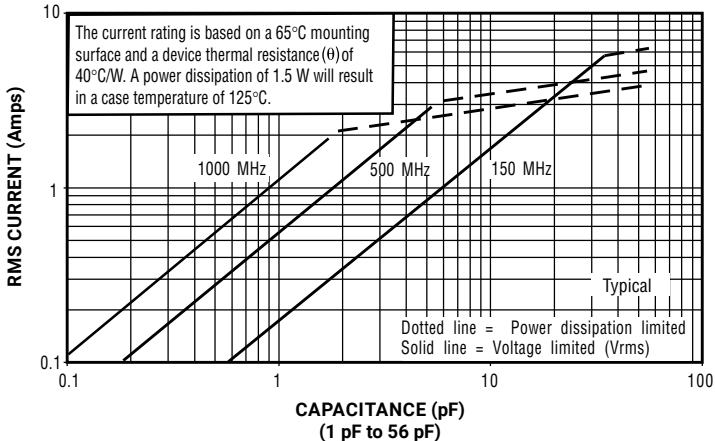

CURRENT RATING VS. CAPACITANCE
SERIES 700, CASE A, EXTENDED VOLTAGE

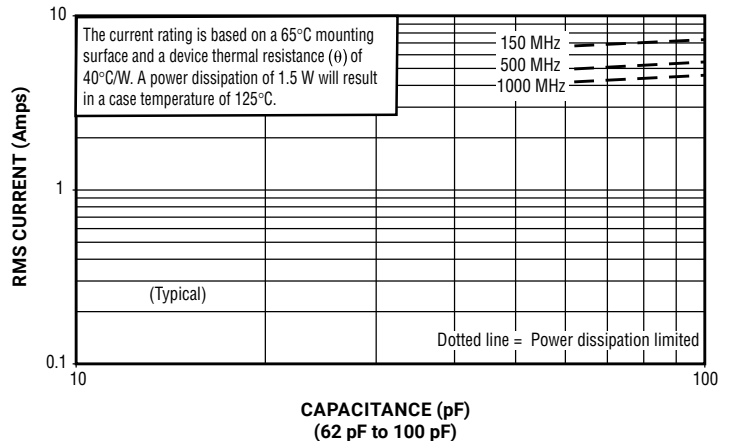

RF/Microwave Capacitors
RF/Microwave Multilayer Capacitors (MLC)
700A Series NP0 Porcelain and Ceramic Multilayer Capacitors



SAMPLE KITS

Kit #	RoHS Compliant	Item Number	Description	Cap. Value Range (pF)	Cap Value (pF)	Tol.	Price
Kit 4	-	DK0004	700A Porcelain and Ceramic 16 different values, 15 pc. min. per value	0.1 to 2.0	0.1, 0.2, 0.3, 0.4, 0.5, 0.6, 0.7, 0.8, 0.9, 1.0, 1.1, 1.2, 1.5	±0.1	\$158.40
Kit 4T		DK0004T			1.5, 1.8, 2.0	±0.25	
Kit 5	-	DK0005	700A Porcelain and Ceramic 16 different values, 15 pc. min. per value	1.0 to 10	1.0, 1.2, 1.5, 1.8, 2.0, 2.2, 2.4, 2.7, 3.0, 3.3,	±0.1	\$158.40
Kit 5T		DK0005T			3.9, 4.7, 5.6, 6.8, 8.2	±0.25	
Kit 6	-	DK0006	700A Porcelain and Ceramic 16 different values, 15 pc. min. per value	10 to 100	10, 12, 15, 18, 20, 22, 24, 27, 30, 33, 39, 47, 56, 68, 82, 100	± 5%	\$158.40
Kit 6T		DK0006T					
Kit 7	-	DK0007	700A Porcelain and Ceramic 16 different values, 15 pc. min. per value	100 to 1000	100, 120, 150, 180, 200, 220, 240, 270 300, 330, 390, 470	±5%	\$158.40
Kit 7T		DK0007T			560, 680, 820, 1000.....	±10	

RF/Microwave Capacitors

RF/Microwave Multilayer Capacitors (MLC)

700B Series NPO Porcelain and Ceramic Multilayer Capacitors

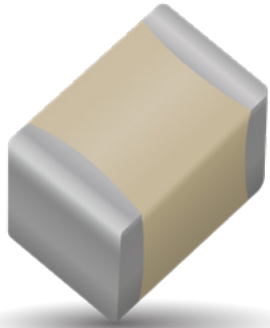

FEATURES

- Case B Size (.110" x .110")
- Capacitance Range 0.1 pF to 5100 pF
- Extended WVDC up to 1500 VDC
- Low ESR/ESL
- High Q
- Low Noise
- Ultra-Stable Performance
- High Self-Resonance
- Established Reliability (QPL)

GENERAL DESCRIPTION

KYOCERA AVX, the industry leader, is announcing new improved ESR/ESL performance for the 700B Series RF/Microwave Capacitors. The superior high self-resonance and zero TCC characteristic of this Series provide excellent performance over a broad range of RF and microwave applications requiring minimum drift, including RF power. Porcelain and ceramic construction provide a rugged, hermetic package.

FUNCTIONAL APPLICATIONS

- Bypass
- Impedance Matching
- Coupling
- DC Blocking
- Tuning

CIRCUIT APPLICATIONS

- Timing Power Amplifiers
- RF Power Amplifiers
- Filters
- Oscillators

ENVIRONMENTAL CHARACTERISTICS

Thermal Shock	Mil-STD-202, Method 107, Condition A
Moisture Resistance	Mil-STD-202, Method 106
Low Voltage Humidity	Mil-STD-202, Method 103, condition A, with 1.5 VDC applied while subjected to an environment of 85°C with 85% relative humidity for 240 hours
Life Test	MIL-STD-202, Method 108, for 2000 hours, at 125°C. Voltage applied. 200% of WVDC for capacitors rated at 500 volts DC or less. 120% of WVDC for capacitors rated at 1250 volts DC or less. 100% of WVDC for capacitors rated above 1250 volts DC
Termination Styles	Available in various surface mount and leaded styles. See Mechanical Configurations
Terminal Strength	Terminations for chips and pellets withstand a pull of 5 lbs. min., 15 lbs. typical, for 5 seconds in direction perpendicular to the termination surface of the capacitor.

AVX 700B Series Capacitors are designed and manufactured to meet and exceed the requirements of EIA-198, MIL-PRF-55681 and MIL-PRF-123.

PACKAGING OPTIONS



Tape & Reel



Vertical Orientation Tape & Reel



Cap Pac® (100 pcs)



ELECTRICAL SPECIFICATIONS

Temperature Coefficient (TCC)	0 ±30 PPM/°C (-55°C to +125°C)
Capacitance Range	0.1 pF to 5100 pF
Operating Temperature	0.1 to 200 pF: from -55°C to +175°C 220 to 5100 pF: from -55°C to +125°C
Quality Factor	Greater than 10,000 (1 pF to 200 pF) @ 1 MHz. Greater than 2000 (220 pF to 1000 pF) @ 1 MHz. Greater than 2000 (1100 pF to 5100 pF) @ 1 KHz.
Insulation Resistance (IR)	0.1 pF to 470 pF: 10 ⁶ Megohms min. @ +25°C at rated WVDC. 10 ⁵ Megohms min. @ +125°C at rated WVDC. 510 pF to 5100 pF: 10 ⁵ Megohms min. @ +25°C at rated WVDC. 10 ⁴ Megohms min. @ +125°C at rated WVDC.
Working Voltage (WVDC)	See Capacitance Values table
Dielectric Withstanding Voltage (DWV)	250% of WVDC for capacitors rated at 500 volts DC or less for 5 seconds. 150% of WVDC for capacitors rated at 1250 volts DC or less for 5 seconds. 120% of WVDC for capacitors rated above 1250 Volts DC for 5 seconds
Aging Effects	None
Piezoelectric Effects	None
Capacitance Drift	± (0.02% or 0.02 pF), whichever is greater
Retrace	Less than ±(0.02% or 0.02 pF), whichever is greater.



The Important Information/Disclaimer is incorporated in the catalog where these specifications came from or available online at www.kyocera-avx.com/disclaimer/ by reference and should be reviewed in full before placing any order.

RF/Microwave Capacitors

RF/Microwave Multilayer Capacitors (MLC)

700B Series NPO Porcelain and Ceramic Multilayer Capacitors



CAPACITANCE VALUES

Cap. Code	Cap. (pF)	Tol.	Rated WVDC		Cap. Code	Cap. (pF)	Tol.	Rated WVDC		Cap. Code	Cap. (pF)	Tol.	Rated WVDC		CAP. CODE	CAP. (pF)	TOL.	RATED WVDC												
			STD.	EXT.				STD.	EXT.				STD.	EXT.				STD.	EXT.	STD.	EXT.									
0R1	0.1	B	500	1500	3R3	3.3	B, C, D	500	1500	330	33	F, G, J, K, M	500	VOLT	331	330	F, G, J, K, M	200												
0R2	0.2				3R6	3.6				360	36				361	360														
0R3	0.3	B, C			EXTENDED VOLTAGE	3R9				3.9	1500				EXTENDED VOLTAGE	390				39	1000	EXTENDED VOLTAGE	391	390						
0R4	0.4					4R3				4.3						430				43			431	430						
0R5	0.5	B, C, D			EXTENDED VOLTAGE	4R7				4.7	500				EXTENDED VOLTAGE	470				47	300	EXTENDED VOLTAGE	471	470						
0R6	0.6					5R1				5.1						510				51			511	510						
0R7	0.7					5R6				5.6						560				56			561	560						
0R8	0.8					6R2				6.2						620				62			621	620						
0R9	0.9					B, C, J, K, M				EXTENDED VOLTAGE						6R8				6.8			1500	EXTENDED VOLTAGE	680	68	1000	EXTENDED VOLTAGE	681	680
1R0	1.0															7R5				7.5					750	75			751	750
1R1	1.1		B, C, D	EXTENDED VOLTAGE		8R2	8.2	500	EXTENDED VOLTAGE	820		82	300	EXTENDED VOLTAGE		821	820													
1R2	1.2					9R1	9.1			910		91				911	910													
1R3	1.3					100	10			101		100				102	1000													
1R4	1.4					110	11			111		110				112	1100													
1R5	1.5	120			12	121	120			122	1200																			
1R6	1.6	F, G, J, K, M			EXTENDED VOLTAGE	130	13			200	N/A	131			130	200	N/A	152	1500											
1R7	1.7					150	15					151			150			182	1800											
1R8	1.8					160	16					161			160			222	2200											
1R9	1.9					180	18					181			180			272	2700											
2R0	2.0					200	20					201			200			302	3000											
2R1	2.1		220	22		221	220	332	3300																					
2R2	2.2		240	24		241	240	392	3900																					
2R4	2.4		270	27		271	270	472	4700																					
2R7	2.7		300	30		301	300	512	5100																					
3R0	3.0																													

SPECIAL VALUES, TOLERANCES, DIFFERENT WVDC AND MATCHING AVAILABLE. • ENCAPSULATION OPTION AVAILABLE. PLEASE CONSULT FACTORY.
Capacitance values in **bold** type indicate porcelain dielectric. All other capacitance values indicate ceramic dielectric.

HOW TO ORDER

Series **700** Case Size **B** Capacitance **331** Tolerance Code **J** Termination Style Code **W** Voltage Rating **500** Laser Marking (Optional) **X** Packaging **T**

See mechanical dimensions below

EIA Capacitance Code in pF.
First two digits = significant figures or "R" for decimal place.
Third digit = number of zeros or after "R" significant figures

Code	B	C	D	F	G	J	K	M
Tol.	±1 pF	±25 pF	±5 pF	±1%	±2%	±5%	±10%	±20%

Please see 2nd Column Mechanical Configuration Table

The above part number refers to a 700B Series (case size B) 330 pF capacitor, J tolerance (±5%), 500 WVDC, with W termination (Tin/Lead, Solder Plated over Nickel Barrier), laser marking and Tape and Reel packaging.

RF/Microwave Capacitors

RF/Microwave Multilayer Capacitors (MLC)

700B Series NPO Porcelain and Ceramic Multilayer Capacitors



MECHANICAL CONFIGURATION

Series & Case Size	Term. Code	MIL-PRF-55681	Case Size & Type	Outline W/T is a Termination Surface	Body Dimensions inches (mm)			Lead and Termination Dimensions and Material			Pkg Type	Pkg Code		
					Length (L)	Width (W)	Thickness (T)	Overlap (Y)	Materials					
700B	W	CDR14BP	B Solder Plate		110+.025-.010 (2.79+0.64-0.25)	.110±.015 (2.79±0.38)	.102 (2.59) max.	.015 (0.38) ±.010 (0.25)	Tin/Lead, Solder Plated over Nickel Barrier Termination		T&R, 1000 or 500 pcs Vertical T&R, 1000 or 500 pcs Cap Pac, 100 pcs	T1K or T TV1K or TV C100		
700B	P	CDR14BP	B Pellet		110+.025-.010 (2.79+0.64-0.25)	.110±.015 (2.79±0.38)	.102 (2.59)		Heavy Tin/Lead Coated, over Nickel Barrier Termination		T&R, 1000 or 500 pcs Vertical T&R, 1000 or 500 pcs Cap Pac, 100 pcs	T1K or T TV1K or TV C100		
700B	T	N/A	B Solderable Nickel Barrier		110+.025-.010 (2.79+0.64-0.25)	.110±.015 (2.79±0.38)	.102 (2.59)		RoHS Compliant Tin Plated over Nickel Barrier Termination		T&R, 1000 or 500 pcs Vertical T&R, 1000 or 500 pcs Cap Pac, 100 pcs	T1K or T TV1K or TV C100		
700B	CA	CDR13BP	B Gold Chip		110+.025-.010 (2.79+0.64-0.25)	.110±.015 (2.79±0.38)	.102 (2.59)		RoHS Compliant Gold Plated over Nickel Barrier Termination		T&R, 1000 or 500 pcs Vertical T&R, 1000 or 500 pcs Cap Pac, 100 pcs	T1K or T TV1K or TV C100		
700B	MS	CDR21BP	B Microstrip		.135±.015 (3.43±0.38)	.110±.015 (2.79±0.38)	.120 (3.05) max.	N/A	Length (L _L)	Width (W _L)	Thickness (T _L)	Cap Pac, 20 pcs	C20	
700B	AR	CDR22BP	B Axial Ribbon						.250 (6.35) min.	.093±.005 (2.36±0.13)	.004±.001 (.102±.025)	Box, 20 or 100 pcs	B20 or B100	
700B	RR	CDR24BP	B Radial Ribbon		.145±.020 (3.68±0.51)	.110±.015 (2.79±0.38)	.102 (2.59) max.	N/A	.500 (12.7)	#26 AWG., .016 (.406) dia.nominal		Box, 20 or 100 pcs	B20 or B100	
700B	RW	CDR23BP	B Radial Wire									.950 min.	Box, 20 or 100 pcs	B20 or B100
700B	AW	CDR25BP	B Axial Wire									Box, 20 or 100 pcs	B20 or B100	

Additional lead styles available: Narrow Microstrip (NM), Narrow Axial Ribbon (NA) and Vertical Narrow Microstrip (H). Other lead lengths are available; consult factory. All leads are high purity silver attached with high temperature solder and are RoHS compliant.

RF/Microwave Capacitors

RF/Microwave Multilayer Capacitors (MLC)

700B Series NPO Porcelain and Ceramic Multilayer Capacitors



MECHANICAL CONFIGURATION

Series & Case Size	Term. Code	MIL-PRF-55681	Case Size & Type	Outline W/T is a Termination Surface	Body Dimensions inches (mm)			Lead and Termination Dimensions and Material			Pkg Type	Pkg Code	
					Length (L)	Width (W)	Thickness (T)	Overlap (Y)	Materials				
700B	WN	Meets Requirements	B Non-Mag Solder Plate		.110 +.020 -.010 (2.79 +0.51 -0.25)	.110 ±.015 (2.79 ±0.38)	.102 (2.59) max.	.015 (0.38) ±.010 (0.25)	Tin / Lead, Solder Plated over Non-Magnetic Barrier Termination		T&R, 1000 or 500 pcs Vertical T&R, 1000 or 500 pcs Cap Pac, 100 pcs	T1K or T TV1K or TV C100	
700B	PN	Meets Requirements	B Non-Mag Pellet		.110 +.035 -.010 (2.79 +0.89 -0.25)	.110 ±.015 (2.79 ±0.38)			Heavy Tin / Lead, Coated over Non-Magnetic Barrier Termination		T&R, 1000 or 500 pcs Vertical T&R, 1000 or 500 pcs Cap Pac, 100 pcs	T1K or T TV1K or TV C100	
700B	TN	Meets Requirements	B Non-Mag Solderable Barrier		.110 +.020 -.010 (2.79 +0.51 -0.25)	.110 ±.015 (2.79 ±0.38)			RoHS Compliant Tin Plated over Non-Magnetic Barrier Termination		T&R, 1000 or 500 pcs Vertical T&R, 1000 or 500 pcs Cap Pac, 100 pcs	T1K or T TV1K or TV C100	
700B	MN	Meets Requirements	B Non-Mag Microstrip		.135 ±.015 (3.43 ±0.38)	.110 ±.015 (2.79 ±0.38)	.120 (3.05) max.	N/A	Length (L)	Width (W.)	Thickness (T.)	Cap Pac, 20 pcs	C20
700B	AN	Meets Requirements	B Non-Mag Axial Ribbon						.250 (6.35) min.	.093 ± .005 (2.36 ± 0.13)	.004 ± .001 (.102 ± .025)	Box, 20 or 100 pcs	B20 or B100
700B	FN	Meets Requirements	B Non-Mag Radial Ribbon						.145 ±.020 (3.68 ±0.51)	.120 (2.59) max.	N/A	.500 (12.7) min.	#26 AWG., .016 (.406) dia. nominal
700B	RN	Meets Requirements	B Non-Mag Axial Wire		Box, 20 or 100 pcs	B20 or B100							
700B	BN	Meets Requirements	B Non-Mag Radial Wire							Box, 20 or 100 pcs	B20 or B100		

*Capacitors with values greater than 200 pF contain a trace magnetic element that may exhibit weak magnetic properties.

** Additional lead styles available: Narrow Microstrip (DN), Narrow Axial Ribbon (GN) and Vertical Narrow Microstrip (HN). Other lead lengths are available; consult factory; All leads are high purity silver attached with high temperature solder and RoHS compliant.

SUGGESTED MOUNTING PAD DIMENSIONS

Horizontal
Electrode Orientation

Vertical
Electrode Orientation

Case B Vertical Mount					
Cap Value	Pad Size	A Min.	B Min.	C Min.	D Min.
0.1 pF	Normal	.065	.050	.075	.175
	High Density	.045	.030	.075	.135
0.2 pF	Normal	.090	.050	.075	.175
	High Density	.070	.030	.075	.135
0.3 to 510 pF	Normal	.110	.050	.075	.175
	High Density	.090	.030	.075	.135
> 510 pF	Normal	.120	.050	.075	.175
	High Density	.100	.030	.075	.135

Horizontal Mount					
All Values	Pad Size	A Min.	B Min.	C Min.	D Min.
All Values	Normal	.130	.050	.075	.175
	High Density	.110	.030	.075	.135

PERFORMANCE DATA

**ESR VS. CAPACITANCE
 SERIES 700, CASE B**

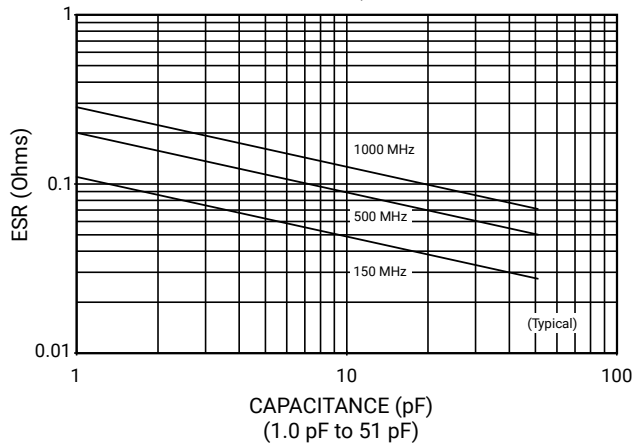

**Q VS. CAPACITANCE
 SERIES 700, CASE B**

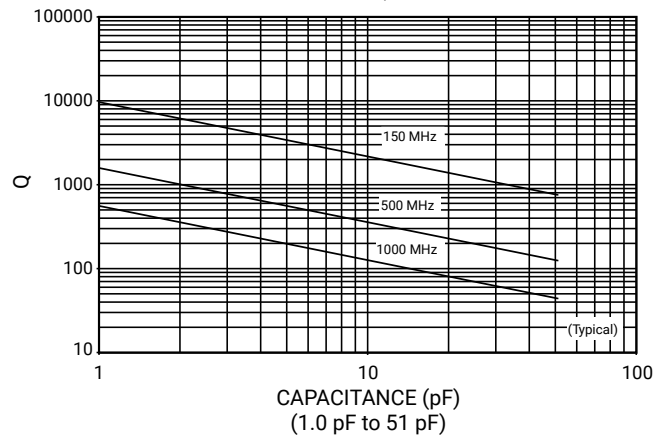

**ESR VS. CAPACITANCE
 SERIES 700, CASE B**

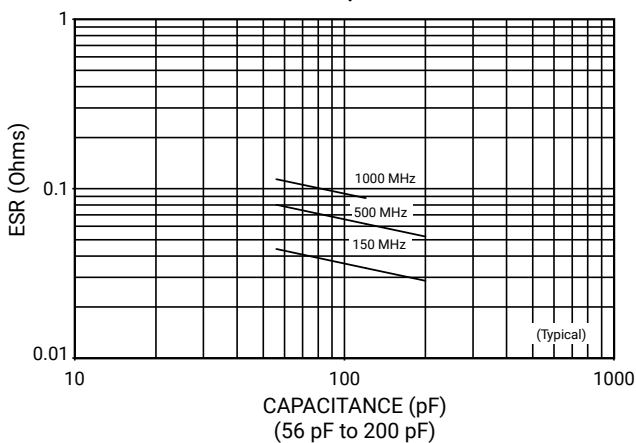

**Q VS. CAPACITANCE
 SERIES 700, CASE B**

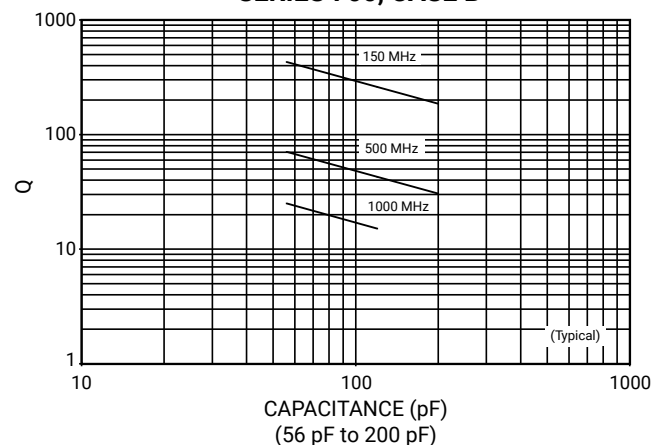

PERFORMANCE DATA

ESR VS. CAPACITANCE
SERIES 700, CASE B

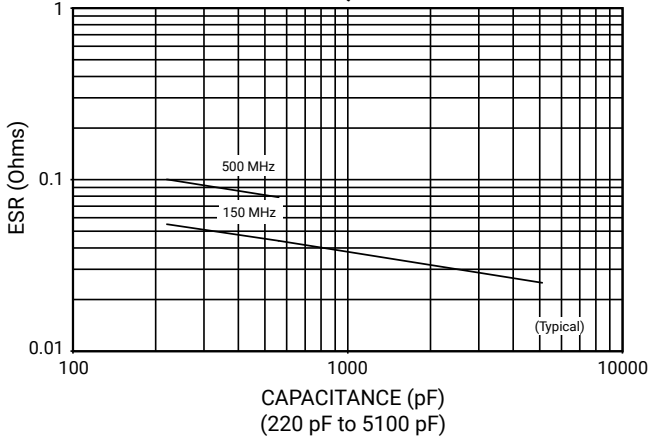

Q VS. CAPACITANCE
SERIES 700, CASE B

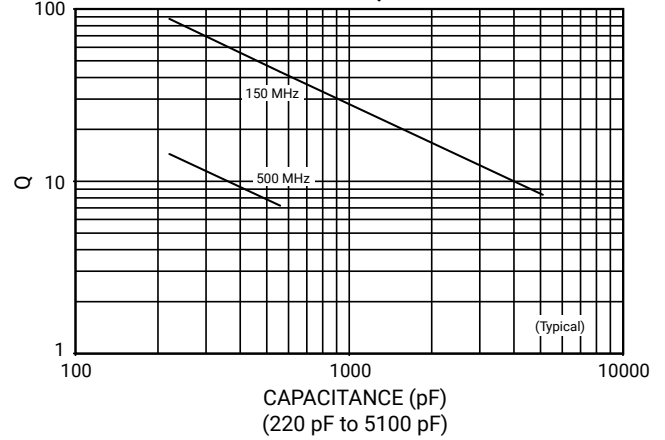

SERIES RESONANCE VS. CAPACITANCE
SERIES 700, CASE B

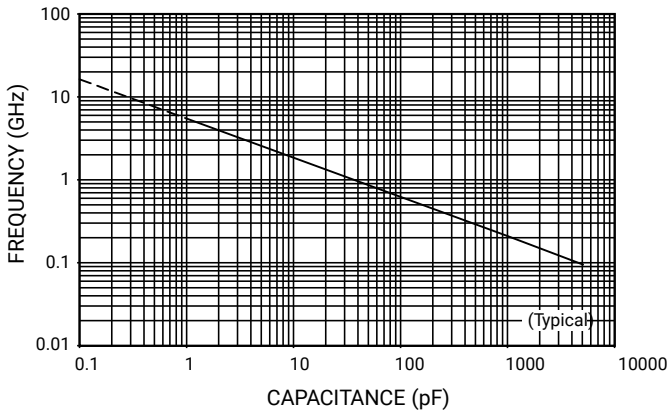

CURRENT RATING VS. CAPACITANCE
SERIES 700, CASE B

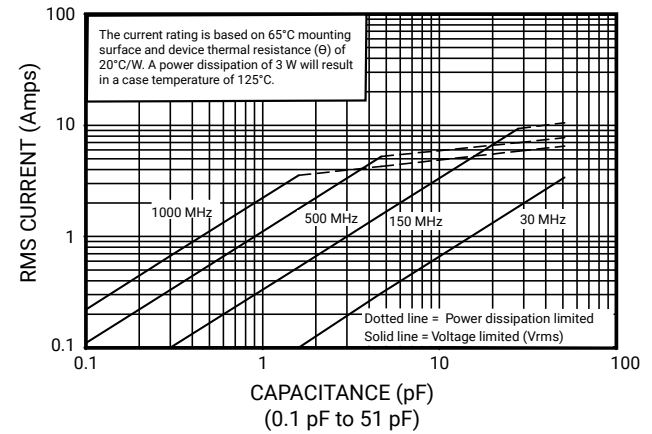

CURRENT RATING VS. CAPACITANCE
SERIES 700, CASE B

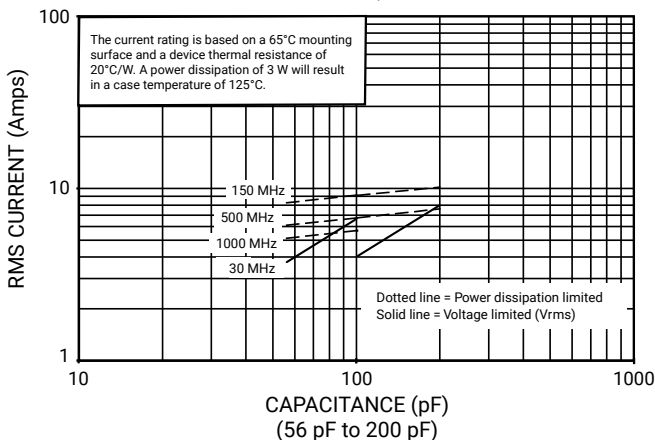

CURRENT RATING VS. CAPACITANCE
SERIES 700, CASE B

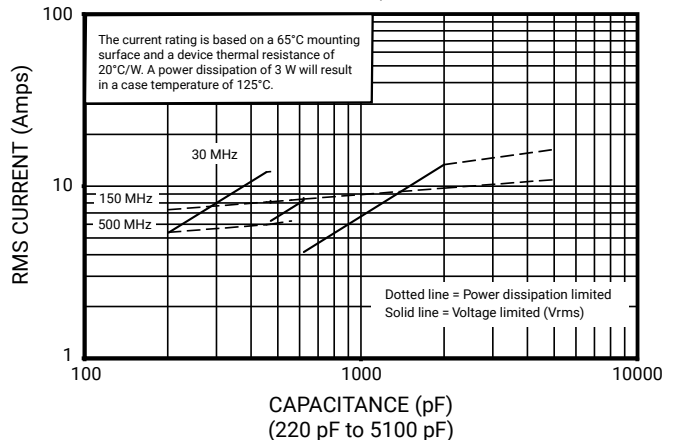

RF/Microwave Capacitors

RF/Microwave Multilayer Capacitors (MLC)

700B Series NPO Porcelain and Ceramic Multilayer Capacitors



PERFORMANCE DATA

CURRENT CHANGE VS. TEMPERATURE
SERIES 700, CASE B

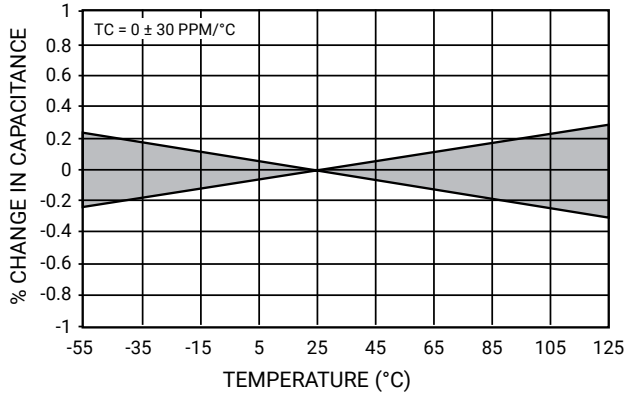

CURRENT RATING VS. CAPACITANCE
SERIES 700, CASE B, EXTENDED VOLTAGE

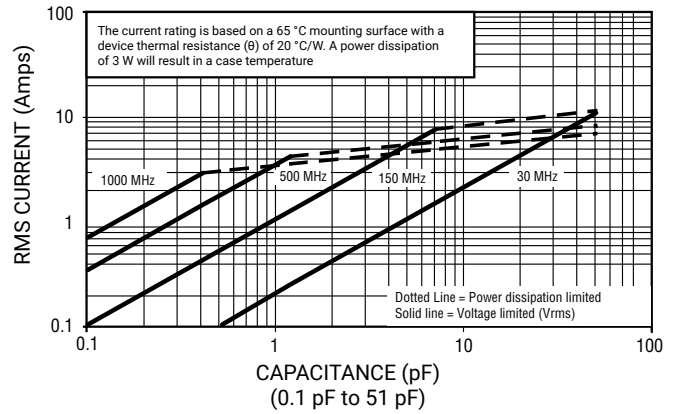

CURRENT RATING VS. CAPACITANCE
SERIES 700, CASE B, EXTENDED VOLTAGE

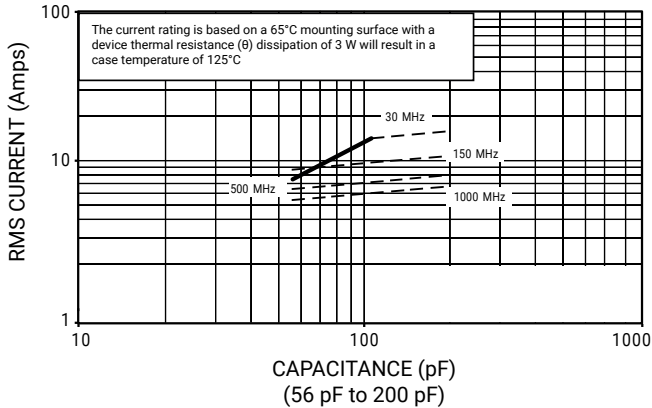

RF/Microwave Capacitors
RF/Microwave Multilayer Capacitors (MLC)
700B Series NPO Porcelain and Ceramic Multilayer Capacitors



SAMPLE KITS

Kit #	RoHS Compliant	Item Number	Description	Cap. Value Range (pF)	Cap Value (pF)	Tol.	Price
Kit 11	-	DK0011	700B Porcelain and Ceramic 16 different values, 15 pcs. min. per value	1.0 to 10	1.0, 1.2, 1.5, 1.8, 2.0, 2.2, 2.4, 2.7, 3.0, 3.3.....	±0.1	\$165.00
Kit 11T		DK0011T			3.9, 4.7, 5.6, 6.8, 8.2 3.9, 4.7, 5.6, 6.8, 8.2	±0.25	
Kit 12	-	DK0012	700B Porcelain and Ceramic 16 different values, 15 pcs. min. per value	10 to 100	10, 12, 15, 18, 20, 22, 24, 27, 30, 33, 39, 47, 56, 68, 82, 100	±5%	\$165.00
Kit 12T		DK0012T					
Kit 13	-	DK0013	700B Porcelain and Ceramic 16 different values, 15 pcs. min. per value	100 to 1000	100, 120, 150, 180, 200, 220, 240, 270, 300, 330, 390, 470	± 5%	\$165.00
Kit 13T		DK0013T			560, 680, 820, 1000.....	±10%	

RF/Microwave Capacitors

RF/Microwave Multilayer Capacitors (MLC)

700C Series NPO Porcelain and Ceramic Multilayer Capacitors

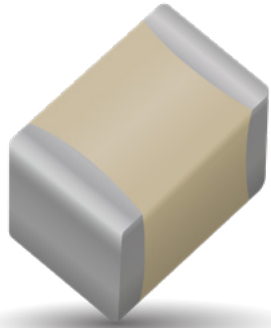

GENERAL DESCRIPTION

KYOCERA AVX, the industry leader, offers new improved ESR/ESL performance for the 700C Series RF Capacitors. This high Q multilayer capacitor is ultra-stable under high RF current and voltage applications. High density porcelain construction provides a rugged, hermetic package.

KYOCERA AVX offers an encapsulation option for applications requiring extended protection against arc-over and corona

FUNCTIONAL APPLICATIONS

- Bypass
- Coupling
- Tuning
- Impedance Matching
- DC Blocking

CIRCUIT APPLICATIONS

- VHF/UHF RF Power Amplifiers
- Antenna Tuning
- Plasma Chambers
- Medical (MRI coils)

*For leaded styles only

ENVIRONMENTAL CHARACTERISTICS

Thermal Shock	MIL-STD-202, Method 107, Condition A
Moisture Resistance	MIL-STD-202, Method 106
Low Voltage Humidity	MIL-STD-202, Method 103, Condition A, with 1.5 Volts DC applied while subjected to an environment of 85°C with 85% relative humidity for 240 hours min.
Life Test	MIL-STD-202, Method 108, for 2000 hours, at 125°C. Voltage applied. 200% of WVDC for capacitors rated at 500 volts DC or less. 120% of WVDC for capacitors rated at 1250 volts DC or less. 100% of WVDC for capacitors rated above 1250 volts DC.
Termination Styles	Available in various surface mount and leaded styles. See Mechanical Configurations
Terminal Strength	Terminations for chips and pellets withstand a pull of 10 lbs. min., 20 lbs. typical, for 5 seconds in direction perpendicular to the termination surface of the capacitor. Test per MIL-STD-202, method 211.

FEATURES

- Case C Size (.250" x .250")
- High Q
- Low ESR/ESL
- High RF Power
- Available with Encapsulation Options*
- Capacitance Range 1 pF to 2700 pF
- Ultra-Stable Performance
- High RF Current/Voltage
- High Reliability

PACKAGING OPTIONS



Tape & Reel



Tray
(180 pcs)



ELECTRICAL SPECIFICATIONS

Quality Factor (Q)	Greater than 10,000 (1.0 pF to 1000 pF) @ 1 MHz. Greater than 10,000 (1100 pF to 2700 pF) @ 1 KHz.
Temperature Coefficient of Capacitance (TCC)	0 ±30 PPM/°C (-55°C to +125°C)
Insulation Resistance (IR)	1 pF to 2700 pF: 10 ⁵ Megohms min. @ +25°C at rated WVDC. 10 ⁴ Megohms min. @ +125°C at rated WVDC. Max. test voltage is 500 VDC.
Working Voltage (WVDC)	See Capacitance Values Table
Dielectric Withstanding Voltage (DWV)	250% of WVDC for capacitors rated at 500 volts DC or less for 5 seconds. 150% of WVDC for capacitors rated at 1250 volts DC or less for 5 seconds. 120% of WVDC for capacitors rated above 1250 volts DC for 5 seconds.
Retrace	Less than ±(0.02% or 0.02 pF), whichever is greater
Aging Effects	None
Piezoelectric Effects	None
Capacitance Drift	±(0.02% or 0.02 pF), whichever is greater
Operating Temperature Range	From -55°C to +125°C (No derating of working voltage)

RF/Microwave Capacitors

RF/Microwave Multilayer Capacitors (MLC)

700C Series NPO Porcelain and Ceramic Multilayer Capacitors



CAPACITANCE VALUES

CAP. CODE	CAP. (pF)	TOL.	RATED WVDC	CAP. CODE	CAP. (pF)	TOL.	RATED WVDC	CAP. CODE	CAP. (pF)	TOL.	RATED WVDC	CAP. CODE	CAP. (pF)	TOL.	RATED WVDC
1R0	1.0	B, C, D	2500	5R1	5.1	B, C, D	2500	390	39	F, G, J K, M	2500	301	300	F, G, J K, M	1500
1R1	1.1			5R6	5.6			430	43			331	330		
1R2	1.2			6R2	6.2			470	47			361	360		
1R3	1.3			6R8	6.8			510	51			391	390		
1R4	1.4			7R5	7.5			560	56			431	430		
1R5	1.5			8R2	8.2			620	62			471	470		
1R6	1.6			9R1	9.1			680	68			511	510		
1R7	1.7			100	10			750	75			561	560		
1R8	1.8			110	11			820	82			621	620		
1R9	1.9			120	12			910	91			681	680		
2R0	2.0	B, C, D	2500	130	13	F, G, J K, M	2500	101	100	F, G, J K, M	2500	751	750	F, G, J K, M	1000
2R1	2.1			150	15			111	110			821	820		
2R2	2.2			160	16			121	120			911	910		
2R4	2.4			180	18			131	130			102	1000		
2R7	2.7			200	20			151	150			112	1100		
3R0	3.0			220	22			161	160			122	1200		
3R3	3.3			240	24			181	180			152	1500		
3R6	3.6			270	27			201	200			182	1800		
3R9	3.9			300	30			221	220			222	2200		
4R3	4.3			330	33			241	240			242	2400		
4R7	4.7	360	36	271	270	272	2700	300							

HOW TO ORDER

Series **700** Case Size **C** Capacitance **100** Capacitance Tolerance Code **J** Termination Code **W** WVDC **2500** Laser Marking (Optional) **X** Packaging **T**

See mechanical dimensions below

EIA Capacitance Code in pF.
First two digits = significant figures or "R" for decimal place.
Third digit = number of zeros or after "R" significant figures

Code	B	C	D	F	G	J	K	M
Tol.	±0.1 pF	±0.25 pF	±0.5 pF	±1%	±2%	±5%	±10%	±20%

T = Tape and Reel, 500 pc. qty. Surface Mount Termination Only
Please see last column of mechanical configuration table for other options.

Please see 2nd Column Mechanical Configuration Table

The above part number refers to a 700C Series (case size C) 10 pF capacitor, J tolerance (±5%), 2500 WVDC, with W termination (Tin/Lead, Solder Plated over Nickel Barrier), laser marking and 500 pc T&R packaging.

MECHANICAL CONFIGURATIONS

SERIES & CASE SIZE	TERM. CODE	CASE SIZE & TYPE	OUTLINES W/T IS A TERMINATION SURFACE	BODY DIMENSIONS INCHES (mm)			LEAD AND TERMINATION DIMENSIONS AND MATERIALS			
				LENGTH (L)	WIDTH (W)	THICKNESS (T)	OVERLAP (Y)	MATERIALS	Pkg Type	Pkg Code
700C	W	Solder Plate		.230+.020-.010 (5.84+0.51-0.25)	.250 ±.015 (6.35 ±0.38)	.145 (3.68) max. for capacitance values ≤ 680 pF; .165 (4.19) max. for capacitance values > 680 pF.	.040 (1.02) max.	Tin /Lead, Solder Plated over Nickel Barrier Termination	T&R, 250 or 500 pcs Tray, 36 or 180 pcs	T250 or T J36 or J180
700C	P	Pellet		.230+.025-.010 (5.84+0.64-0.25)				Heavy Tin/Lead Coated, over Nickel Barrier Termination	T&R, 250 or 500 pcs Tray, 36 or 180 pcs	T250 or T J36 or J180
700C	T	Solderable Nickel Barrier		.230+.020-.010 (5.84+0.51-0.25)				RoHS Compliant Tin Plated over Nickel Barrier Termination	T&R, 250 or 500 pcs Tray, 36 or 180 pcs	T250 or T J36 or J180
700C	MS	Microstrip		.245 ±.025 (6.22 ±0.64)			N/A	High Purity Silver Leads LL = .500 (12.7) min. WL = .240 ±.005 (6.10 ±.127) TL = .004 ±.001 (.102 ±.025) Leads are Attached with High Temperature Solder.	Tray, 24 or 60 pcs	J24 or J60
700C	AR	Axial Ribbon							Box, 24	B24

NON-MAGNETIC MECHANICAL CONFIGURATION

SERIES & CASE SIZE	TERM. CODE	CASE SIZE & TYPE	OUTLINES W/T IS A TERMINATION SURFACE	BODY DIMENSIONS INCHES (mm)			LEAD AND TERMINATION DIMENSIONS AND MATERIALS			
				LENGTH (L)	WIDTH (W)	THICKNESS (T)	OVERLAP (Y)	MATERIALS	Pkg Type	Pkg Code
700C	WN	Solder Plate		.230+.020-.010 (5.84+0.51-0.25)	.250 ±.015 (6.35 ±0.38)	.145 (3.68) max. for capacitance values ≤ 680 pF; .165 (4.19) max. for capacitance values > 680 pF.	.040 (1.02) max.	Tin/Lead, Solder Plated over Non-Magnetic Barrier Termination	T&R, 250 or 500 pcs Tray, 36 or 180 pcs	T250 or T J36 or J180
700C	PN	Pellet		.230+.025-.010 (5.84+0.64-0.25)				Heavy Tin/Lead Coated, over Non-Magnetic Barrier Termination	T&R, 250 or 500 pcs Tray, 36 or 180 pcs	T250 or T J36 or J180
700C	TN	Solderable Nickel Barrier		.230+.020-.010 (5.84+0.51-0.25)				RoHS Compliant Tin Plated over Non-Magnetic Barrier Termination	T&R, 250 or 500 pcs Tray, 36 or 180 pcs	T250 or T J36 or J180
700C	MN	Microstrip		.245 ±.025 (6.22 ±0.64)			N/A	High Purity Silver Leads L _L = .500 (12.7) min. W _L = .240 ±.005 (6.10 ±.127) T _L = .004 ±.001 (.102 ±.025) Leads are Attached with High Temperature Solder.	Tray, 24 or 60 pcs	J24 or J60
700C	AN	Axial Ribbon							Tray, 24 or 60 pcs	J24 or J60

RF/Microwave Capacitors

RF/Microwave Multilayer Capacitors (MLC)

700C Series NPO Porcelain and Ceramic Multilayer Capacitors



SUGGESTED MOUNTING PAD DIMENSIONS

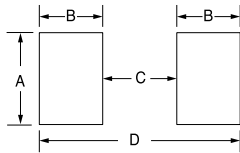
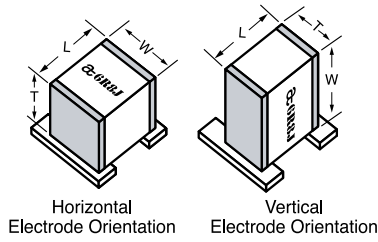

Case C Vertical Mount					
Cap Value	Pad Size	A Min.	B Min.	C Min.	D Min.
< 680 pF	Normal	.150	.050	.200	.300
	High Density	.130	.030	.200	.260
> 680 pF	Normal	.185	.050	.200	.300
	High Density	.165	.030	.200	.260

Horizontal Mount					
All Values	Pad Size	A Min.	B Min.	C Min.	D Min.
All Values	Normal	.280	.050	.200	.300
	High Density	.260	.030	.200	.260

PERFORMANCE DATA

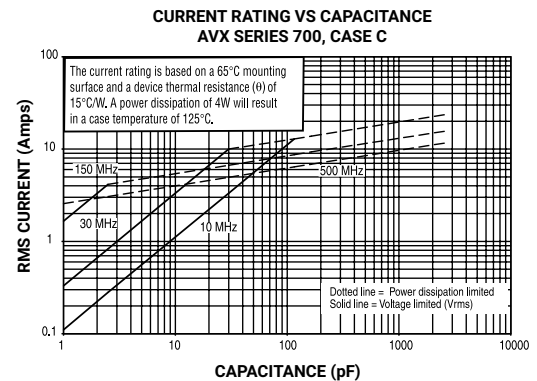
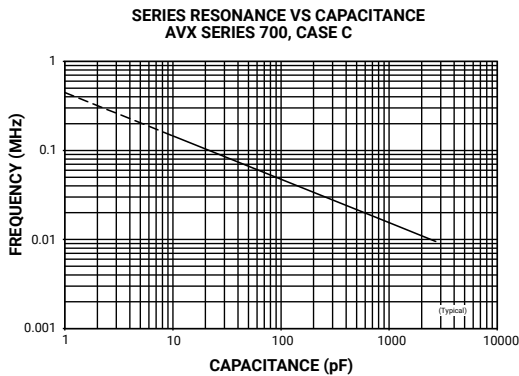
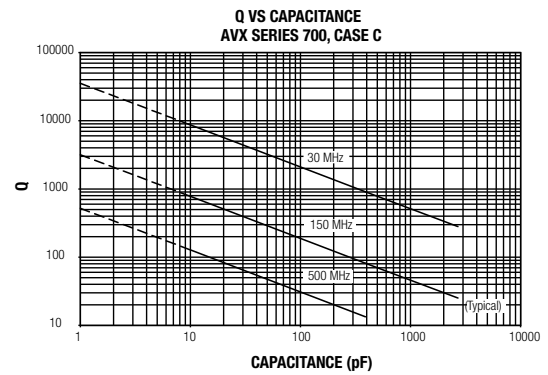
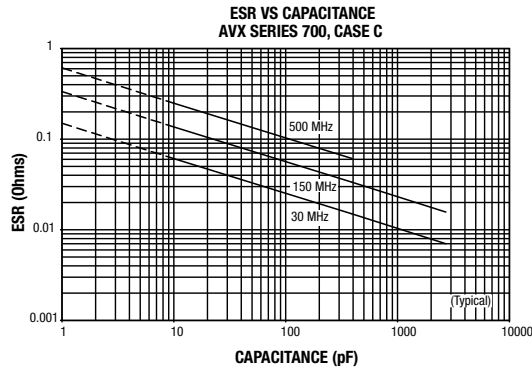

RF/Microwave Capacitors
RF/Microwave Multilayer Capacitors (MLC)
700C Series NPO Porcelain and Ceramic Multilayer Capacitors



PERFORMANCE DATA

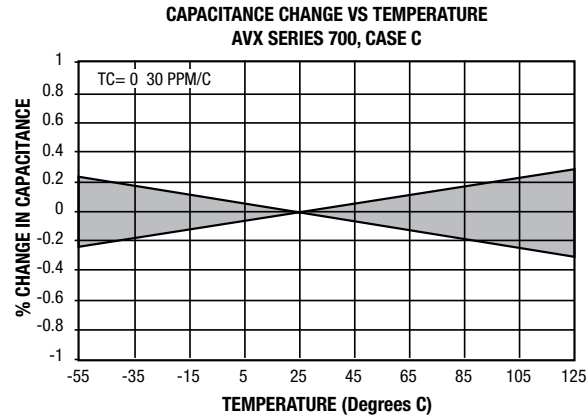

RF/Microwave Capacitors

RF/Microwave Multilayer Capacitors (MLC)

700E Series NPO Porcelain High RF Power Multilayer Capacitors

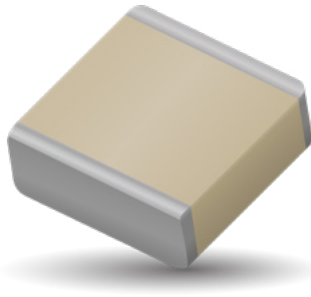

GENERAL DESCRIPTION

KYOCERA AVX, the industry leader, offers new improved ESR/ESL performance for the 700 E Series RF Capacitors. This high Q multilayer capacitor is ultra-stable under high RF current and voltage applications with NPO performance. High density porcelain construction provides a rugged, hermetic package.

KYOCERA AVX offers an encapsulation option for applications requiring extended protection against arc-over and corona.

FUNCTIONAL APPLICATIONS

- Bypass
- Impedance Matching
- Coupling
- DC Blocking
- Tuning

CIRCUIT APPLICATIONS

- HF/RF Power Amplifiers
- Plasma Chambers
- Transmitters
- Medical (MRI coils)
- Antenna Tuning

ENVIRONMENTAL CHARACTERISTICS

Thermal Shock	Mil-STD-202, Method 107, Condition A
Moisture Resistance	Mil-STD-202, Method 106
Low Voltage Humidity	Mil-STD-202, Method 103, condition A, with 1.5 VDC applied while subjected to an environment of 85°C with 85% relative humidity for 240 hours
Life Test	MIL-STD-202, Method 108, for 2000 hours, at 125°C. Voltage applied. 120% of WVDC for capacitors rated at 1250 volts DC or less. 100% of WVDC for capacitors rated above 1250 volts DC
Termination Styles	Available in various surface mount and leaded styles. See Mechanical Configurations
Terminal Strength	Terminations for chips and pellets withstand a pull of 10 lbs. min., 25 lbs. typical, for 5 seconds in direction perpendicular to the termination surface of the capacitor. Test per MIL-STD-202, method 211.

FEATURES

- Case E Size (.380" x .380")
- Capacitance Range 1pF to 2200pF
- Extended WVDC up to 7200 VDC
- Low ESR/ESL
- High Q
- High RF Power
- Ultra-Stable Performance
- High RF Current/Voltage
- Available with Encapsulation Option*

* For leaded styles only

PACKAGING OPTIONS



Tape & Reel



Tray
(96 pcs)



ELECTRICAL SPECIFICATIONS

Temperature Coefficient (TCC)	0 ±30 PPM/°C (-55°C to +125°C)
Capacitance Range	1 pF to 2200 pF
Operating Temperature	-55°C to +125°C (No derating of working voltage).
Quality Factor	Greater than 10,000 (1 pF to 1000 pF) @ 1 MHz. Greater than 10,000 (1100 pF to 2200 pF) @ 1 KHz.
Insulation Resistance (IR)	1 pF to 2200 pF 10 ⁵ Megohms min. @ 25°C at 500 VDC 10 ⁴ Megohms min. @ 125°C at 500 VDC
Working Voltage (WVDC)	See Capacitance Values table
Dielectric Withstanding Voltage (DWV)	150% of WVDC for capacitors rated at 1250 volts DC or less for 5 seconds. 120% of WVDC for capacitors rated above 1250 Volts DC for 5 seconds
Aging Effects	None
Piezoelectric Effects	None
Capacitance Drift	± (0.02% or 0.02 pF), whichever is greater
Retrace	Less than ±(0.02% or 0.02 pF), whichever is greater.

RF/Microwave Capacitors

RF/Microwave Multilayer Capacitors (MLC)

700E Series NPO Porcelain High RF Power Multilayer Capacitors



CAPACITANCE VALUES

Cap. Code	Cap. (pF)	Tol.	Rated WVDC		Cap. Code	Cap. (pF)	Tol.	Rated WVDC		Cap. Code	Cap. (pF)	Tol.	Rated WVDC		CAP. CODE	CAP. (pF)	TOL.	RATED WVDC		
			STD.	EXT.				STD.	EXT.				STD.	EXT.				STD.	EXT.	
1R0	1.0	B, C, D	3600	EXTENDED VOLTAGE	5R1	5.1	B, C, D	EXTENDED VOLTAGE	390	39	F, G, J, K, M	3600	VOLTAGE	271	270	F, G, J, K, M	3600	N/A	N/A	
1R1	1.1				5R6	5.6			430	43				301	300					
1R2	1.2				6R2	6.2			470	47				331	330					
1R3	1.3				6R8	6.8			510	51				361	360					
1R4	1.4				7R5	7.5			560	56				391	390					
1R5	1.5				8R2	8.2			620	62				431	430					
1R6	1.6				9R1	9.1			680	68				471	470					
1R7	1.7				EXTENDED VOLTAGE	100			10	750				75	511					510
1R8	1.8					110			11	820				82	561					560
1R9	1.9					120			12	910				91	621					620
2R0	2.0	130	13	101		100	681	680												
2R1	2.1	150	15	111		110	751	750												
2R2	2.2	EXTENDED VOLTAGE	160	16		121	120	821	820											
2R4	2.4		180	18		131	130	911	910											
2R7	2.7		200	20		151	150	102	1000											
3R0	3.0		220	22		161	160	112	1100											
3R3	3.3		240	24		181	180	122	1200											
3R6	3.6		270	27	201	200	152	1500												
3R9	3.9		300	30	221	220	182	1800												
4R3	4.3		330	33	241	240	222	2200												
4R7	4.7		360	36																

VRMS = 0.707 X WVDC

• SPECIAL VALUES, TOLERANCES, MATCHING, AND CAPACITOR ASSEMBLIES ARE AVAILABLE. • KYOCERA AVX'S CUSTOM POWER CAPACITOR ASSEMBLY CATALOG, LISTS ASSEMBLY OPTIONS. • DIFFERENT WORKING VOLTAGES ARE AVAILABLE • ENCAPSULATION OPTION AVAILABLE. PLEASE CONSULT FACTORY.

HOW TO ORDER

Series **700** Case Size **E** Capacitance **391** Tolerance **K** Voltage Rating **W** Termination **3600** Laser Marking **X**** Packaging **T**

Series 700 E Series (case size E) 390 pF capacitor, K tolerance (±10%), 3600 WVDC, with W termination (Tin /Lead, Solder Plated over Nickel Barrier), laser marking and Tape and Reel Packaging.

Case Size See mechanical dimensions below

Capacitance EIA Capacitance Code in pF. First two digits = significant figures or "R" for decimal place. Third digit = number of zeros or after "R" significant figures

Capacitance Tolerance Code

Code	B	C	D	F	G	J	K	M
Tol.	±1 pF	±25 pF	±5 pF	±1%	±2%	±5%	±10%	±20%

Packaging T = Tape and Reel, 250 pc qty. Please see last Column Mechanical Configuration Table for Box and Tray Options

Laser Marking (Optional)

Voltage Rating

Termination Style Code Please see 2nd Column Mechanical Configuration Table

**Optional

The above part number refers to a 700 E Series (case size E) 390 pF capacitor, K tolerance (±10%), 3600 WVDC, with W termination (Tin /Lead, Solder Plated over Nickel Barrier), laser marking and Tape and Reel Packaging.

RF/Microwave Capacitors

RF/Microwave Multilayer Capacitors (MLC)

700E Series NPO Porcelain High RF Power Multilayer Capacitors



MECHANICAL CONFIGURATION

Series & Case Size	Term. Code	Case Size & Type	Outline W/T is a Termination Surface	Body Dimensions inches (mm)			Lead and Termination Dimensions and Material		Pkg Type	Pkg Code	
				Length (L)	Width (W)	Thickness (T)	Overlap (Y)	Materials			
700E	W	Solder Plate		.380+.015-.010 (9.65+0.38-0.25)		170 (4.32) max.	.040 (1.02) max.	Tin/Lead, Solder Plated over Nickel Barrier Termination	T&R, 250 pcs Tray, 24 or 96 pcs	T J24 J96	
700E	P	Pellet						.380+.040-.010 (9.65+1.02-0.25)	Heavy Tin/Lead Coated, over Nickel Barrier Termination	T&R, 250 pcs Tray, 24 or 96 pcs	T J24 J96
700E	T	Solderable Nickel Barrier						.380+.015-.010 (9.65+0.38-0.25)	RoHS Compliant Tin Plated over Nickel Barrier Termination	T&R, 250 pcs Tray, 24 or 96 pcs	T J24 J96
700E	MS	Microstrip		.380+.035-.010 (9.65+0.89-0.25)		170 (4.32) max.	N/A	High Purity Silver Leads $L_L = .750 (19.05) \text{ min}$ $W_L = .350 \pm .010 (8.89 \pm 0.25)$ $T_L = .010 \pm .005 (0.25 \pm 0.13)$ Leads are Attached with High Temperature Solder.	Tray, 16 or 32 pcs	J16 J32	
700E	AR	Axial Ribbon						Silver-plated Copper Leads Dia. = $.032 \pm .002 (.813 \pm .051)$ $L_L = 2.25 (57.2) \text{ min.}$	Tray, 16 or 32 pcs	J16 J32	
700E	AW	Axial Wire						Silver-plated Copper Leads Dia. = $.032 \pm .002 (.813 \pm .051)$ $L_L = 1.0 (25.4) \text{ min.}$	Box, 20 pcs	B20	
700E	RW	Radial Wire							Tray, 16 or 64 pcs	J16 J64	

Custom lead styles and lengths are available; consult factory. All leads are high purity silver attached with high temperature solder and are **RoHS** compliant.

RF/Microwave Capacitors

RF/Microwave Multilayer Capacitors (MLC)

700E Series NPO Porcelain High RF Power Multilayer Capacitors



MECHANICAL CONFIGURATION

Series & Case Size	Term. Code	Case Size & Type	Outline W/T is a Termination Surface	Body Dimensions inches (mm)			Lead and Termination Dimensions and Material		Pkg Type	Pkg Code
				Length (L)	Width (W)	Thickness (T)	Overlap (Y)	Materials		
700E	WN	Non-Mag Solder Plate		.380+.015-.010 (9.65+0.38-0.25)	.380 ±.010 (9.65 ±0.25)	.170 (4.32) max.	.040 (1.02) max.	Tin/Lead, Solder Plated over Non-Magnetic Barrier Termination	T&R, 250 pcs Tray, 24 or 96 pcs	T J24 J96
700E	PN	Non-Mag Pellet		.380+.040-.010 (9.65+1.02-0.25)				Heavy Tin/Lead Coated, over Non-Magnetic Barrier Termination	T&R, 250 pcs Tray, 24 or 96 pcs	T J24 J96
700E	TN	Non-Mag Solderable Barrier		.380+.015-.010 (9.65+0.38-0.25)				RoHS Compliant Tin Plated over Non-Magnetic Barrier Termination	T&R, 250 pcs Tray, 24 or 96 pcs	T J24 J96
700E	MN	Non-Mag Microstrip		.380+.035-.010 (9.65+0.89-0.25)			N/A	High Purity Silver Leads $L_L = .750$ (19.05) min $W_L = .350 \pm .010$ (8.89 ±0.25) $T_L = .010 \pm .005$ (0.25 ±0.13) Leads are Attached with High Temperature Solder.	Tray, 16 or 32 pcs	J16 J32
700E	AN	Non-Mag Axial Ribbon							Tray, 16 or 32 pcs	J16 J32
700E	BN	Non-Mag Axial Wire						Silver-plated Copper Leads Dia. = .032 ±.002 (.813 ±.051) $L_L = 2.25$ (57.2) min.	Box, 20 pcs	B20
700E	RN	Non-Mag Radial Wire			Silver-plated Copper Leads Dia. = .032 ±.002 (.813 ±.051) $L_L = 1.0$ (25.4) min.	Tray, 16 or 64 pcs		J16 J64		

Custom lead styles and lengths are available; consult factory. All leads are high purity silver attached with high temperature solder and are **RoHS** compliant.

RF/Microwave Capacitors

RF/Microwave Multilayer Capacitors (MLC)

700E Series NPO Porcelain High RF Power Multilayer Capacitors



SUGGESTED MOUNTING PAD DIMENSIONS

Horizontal
Electrode Orientation

Vertical
Electrode Orientation

Mount Type	Case E				
	Pad Size	A Min.	B Min.	C Min.	D Min.
Vertical Mount	Normal	.185	.050	.325	.425
	High Density	.165	.030	.325	.385
Horizontal Mount	Normal	.405	.050	.325	.425
	High Density	.383	.030	.325	.385

Dimensions are in inches.

PERFORMANCE DATA

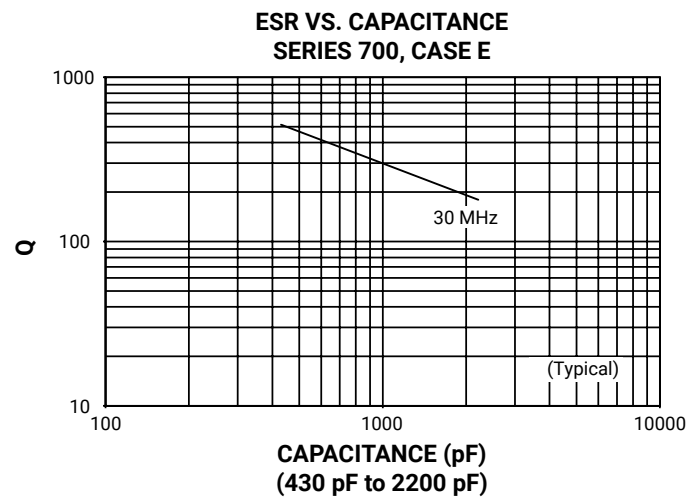
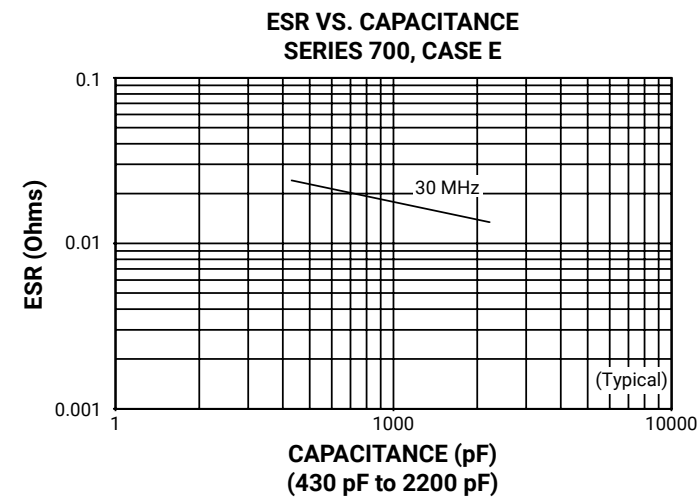
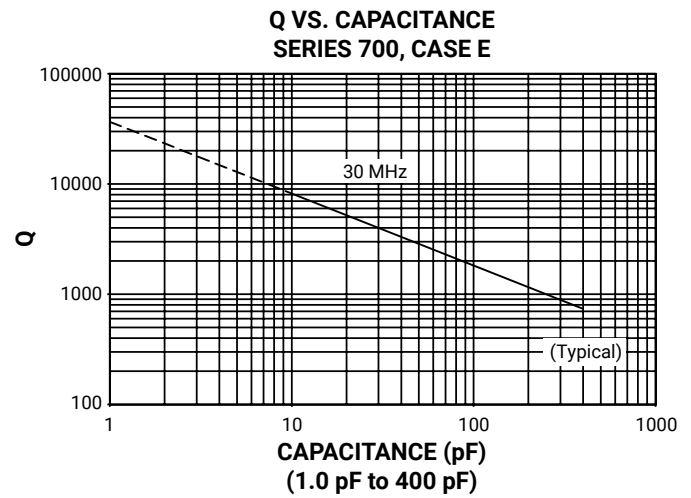
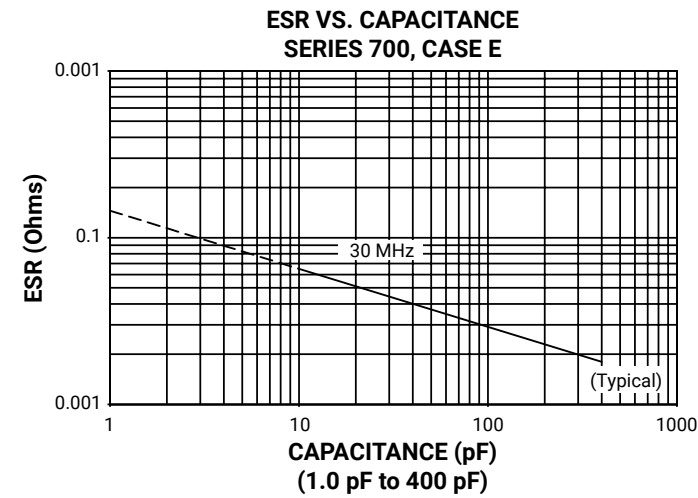

PERFORMANCE DATA

SERIES RESONANCE VS. CAPACITANCE
SERIES 700, CASE E

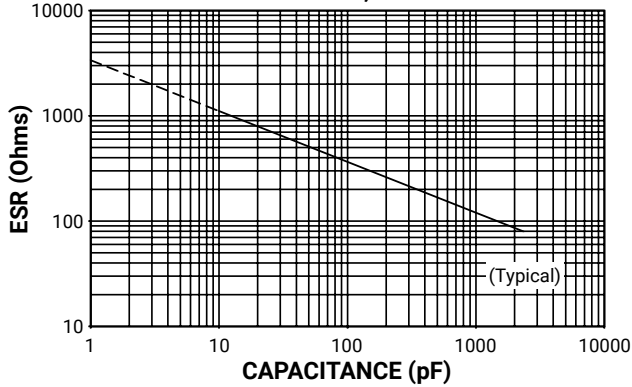

CAPACITANCE CHANGE VS. TEMPERATURE
SERIES 700, CASE E

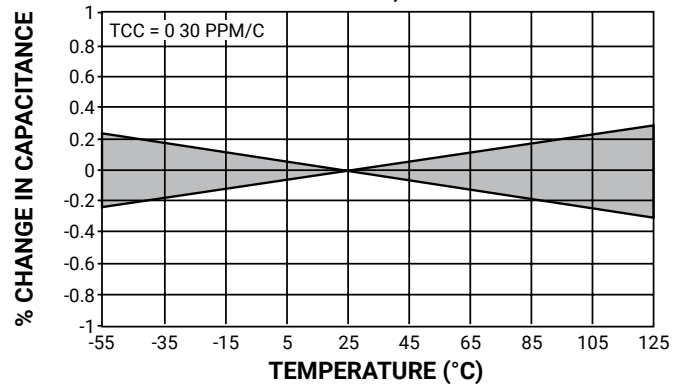

CURRENT RATING VS. CAPACITANCE
SERIES 700, CASE E

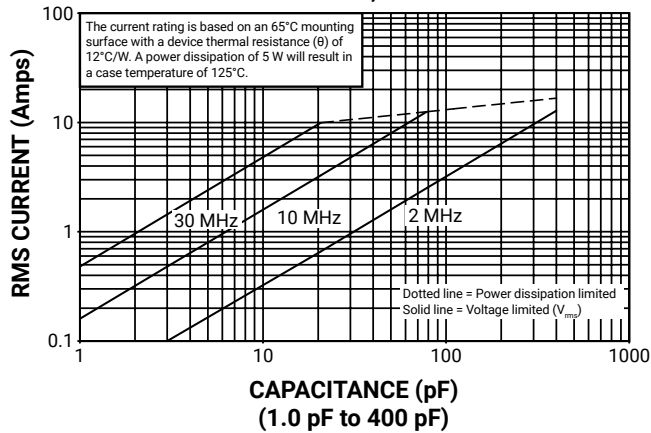

CURRENT RATING VS. CAPACITANCE
SERIES 700, CASE E

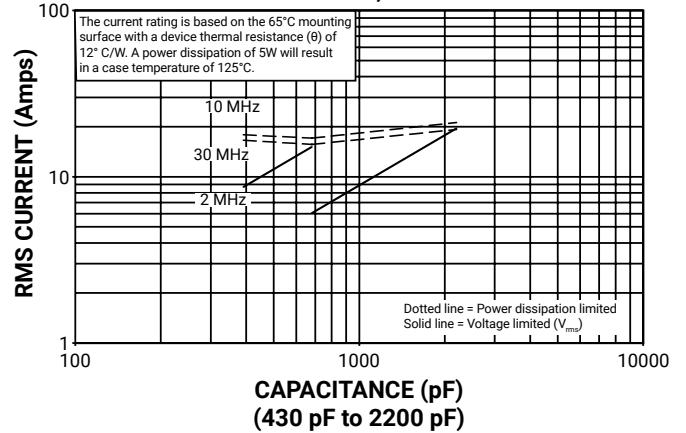

CURRENT RATING VS. CAPACITANCE
SERIES 700, CASE E, EXTENDED VOLTAGE

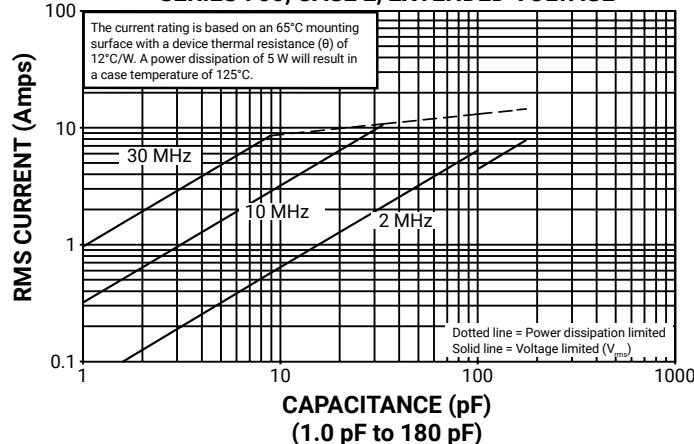

RF/Microwave Capacitors

RF/Microwave Multilayer Capacitors (MLC)

800A Series NP0 Porcelain, High RF Power Ultra-Low ESR

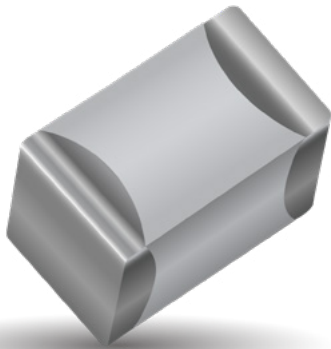

FEATURES

- Case A Size (.055" x .055")
- Low ESR / ESL
- High Q
- Low Noise
- Capacitance Range 0.1pF to 100pF
- Rated WVDC up to 250 VDC
- Zero TCC
- High Self-Resonance
- Established Reliability (QPL)

GENERAL DESCRIPTION

KYOCERA AVX 800 A Series offers superb performance in demanding high RF power applications requiring consistent and reliable operation. The combination of highly conductive metal electrode systems, optimized case geometries, and proprietary dielectrics, yields the lowest ESR. KYOCERA AVX new NP0 low loss rugged dielectrics are designed to provide superior heat transfer in high RF power applications. Ultra-low ESR and superior thermal performance insure that the 800 A Series products are your best choice for high RF power applications from UHF through microwave frequencies. Typical applications: UHF and Microwave Communications Systems, Wireless Communications, Public Safety Radio, Telecom, WiMAX, and Satellite Systems.

Typical circuit applications: High RF Power Filter Networks, Combiners, Couplers, Matching Networks, Output Coupling, Antenna Coupling, and DC Blocking and Bypassing.

ELECTRICAL SPECIFICATIONS

Temperature Coefficient (TCC)	0 ± 30 PPM/°C
Capacitance Range	0.1pF to 100pF
Operating Temperature	-55°C to +125°C*
Quality Factor	Greater than 2,000 @ 1 MHz.
Insulation Resistance (IR)	0.1 pF to 470 pF 10 ⁵ Megohms min. @ 25°C at rated WVDC 10 ⁵ Megohms min. @ 125°C at rated WVDC
Working Voltage (WVDC)	See Capacitance Values table
Dielectric Withstanding Voltage (DWV)	250% of rated WVDC for 5 seconds
Aging Effects	None
Piezoelectric Effects	None
Capacitance Drift	± (0.02% or 0.02 pF), whichever is greater

PACKAGING OPTIONS

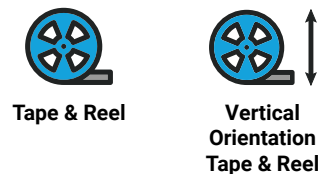

ENVIRONMENTAL CHARACTERISTICS

Thermal Shock	Mil-STD-202, Method 107, Condition A
Moisture Resistance	Mil-STD-202, Method 106
Low Voltage Humidity	Mil-STD-202, Method 103, condition A, with 1.5 VDC applied while subjected to an environment of 85°C with 85% relative humidity for 240 hours
Life Test	MIL-STD-202, Method 108, for 2000 hours, at 125°C. 200% WVDC applied.
Solderability	Mil-STD-202, Method 208
Terminal Strength	Terminations for chips and pellets withstand a pull of 5 lbs. min., 10 lbs. typical, for 5 seconds in direction perpendicular to the termination surface of the capacitor.

RF/Microwave Capacitors

RF/Microwave Multilayer Capacitors (MLC)

800A Series NP0 Porcelain, High RF Power Ultra-Low ESR



CAPACITANCE VALUES

Cap. Code	Cap. (pF)	Tol.	Rated WVDC	Cap. Code	Cap. (pF)	Tol.	Rated WVDC	Cap. Code	Cap. (pF)	Tol.	Rated WVDC
0R1	0.1	B	250	2R2	2.2	B, C, D	250	160	16	F, G, J, K, M	250
0R2	0.2			2R4	2.4			180	18		
0R3	0.3	B, C		2R7	2.7			200	20		
0R4	0.4			3R0	3.0			220	22		
0R5	0.5	B, C, D		3R3	3.3			240	24		
0R6	0.6			3R6	3.6			270	27		
0R7	0.7			3R9	3.9			300	30		
0R8	0.8			4R3	4.3			330	33		
0R9	0.9			4R7	4.7			360	36		
1R0	1.0			5R1	5.1			390	39		
1R1	1.1			5R6	5.6			430	43		
1R2	1.2			6R2	6.2			470	47		
1R3	1.3		6R8	6.8	510	51					
1R4	1.4		7R5	7.5	560	56					
1R5	1.5		8R2	8.2	620	62					
1R6	1.6		9R1	9.1	680	68					
1R7	1.7	100	10	750	75						
1R8	1.8	110	11	820	82						
1R9	1.9	120	12	910	91						
2R0	2.0	130	13	101	100						
2R1	2.1	150	15								

HOW TO ORDER

Series 800

Case Size A
See mechanical dimensions below

Capacitance 100
EIA Capacitance Code in pF.
First two digits = significant figures or "R" for decimal place.
Third digit = number of zeros or after "R" significant figures

Capacitance Tolerance Code J
Code: B, C, D, F, G, J, K, M
Tol.: ±1 pF, ±.25 pF, ±.5 pF, ±1%, ±2%, ±5%, ±10%, ±20%

Termination Style Code T
Please see 2nd Column Mechanical Configuration Table

Voltage Rating 250

Laser Marking (Optional) X

Packaging T
T = Tape and Reel, 500 pc qty
TV = Vertical Orientation of Product Tape and Reel, 500 pc qty
For tray and box options, leave last position blank.
Please see last column mechanical configuration table for package quantities

The above part number refers to a 800A Series (case size A) 10 pF capacitor, J tolerance (±5%), 250 WVDC, with T termination (Tin Plated over Nickel Barrier Termination), Laser Marking and Tape and Reel 4000 pc qty. Packaging

RF/Microwave Capacitors

RF/Microwave Multilayer Capacitors (MLC)

800A Series NP0 Porcelain, High RF Power Ultra-Low ESR



MECHANICAL CONFIGURATION

Series & Case Size	Term. Code	Case Size & Type	Outline ES W/T is a Termination Surface	Body Dimensions inches (mm)			Lead and Termination Dimensions and Material		Pkg Type & Qty	Pkg Code
				Length (L)	Width (W)	Thickness (T)	Overlap (Y)	Materials		
800A	T	A Solderable Nickel Barrier		.055+.015 -.010 (1.40+0.38-0.25)	.055 ±.015 (1.40 ±0.38)	.057 (1.45) max.	.010+.010 -.005 (0.25+0.25-.013)	RoHS Compliant Tin Plated over Nickel Barrier Termination	T&R, 4000 or 500 pcs Vertical T&R, 4000 or 500 pcs	T4K or T TV4K or TV
800A	W	A Solder Plate		.055+.015 -.010 (1.40+0.38-0.25)	.055 ±.015 (1.40 ±0.38)					

NON-MAGNETIC CONFIGURATION

Series & Case Size	Term. Code	Case Size & Type	Non-Magnetic Configuration	Body Dimensions inches (mm)			Lead and Termination Dimensions and Material		Pkg Type & Qty	Pkg Code
				Length (L)	Width (W)	Thickness (T)	Overlap (Y)	Materials		
800A	TN	A Non-Mag Solderable Barrier		.055+.025 -.010 (1.40+0.64-0.25)	.055 ±.015 (1.40 ±0.38)	.057 (1.45) max.	.010+.010 -.005 (0.25+0.25-.013)	RoHS Compliant Tin Plated over Non-Magnetic Barrier Termination	T&R, 4000 or 500 pcs Vertical T&R, 4000 or 500 pcs	T4K or T TV4K or TV

RF/Microwave Capacitors

RF/Microwave Multilayer Capacitors (MLC)

800A Series NP0 Porcelain, High RF Power Ultra-Low ESR



SUGGESTED MOUNTING PAD DIMENSIONS

Horizontal Electrode Orientation

Vertical Electrode Orientation

Case A					
Mount Type	Pad Size	A Min.	B Min.	C Min.	D Min.
Vertical Mount	Normal	.070	.050	.030	.130
	High Density	.050	.030	.030	.090
Horizontal Mount	Normal	.080	.050	.030	.130
	High Density	.060	.030	.030	.090

Dimensions are in inches.

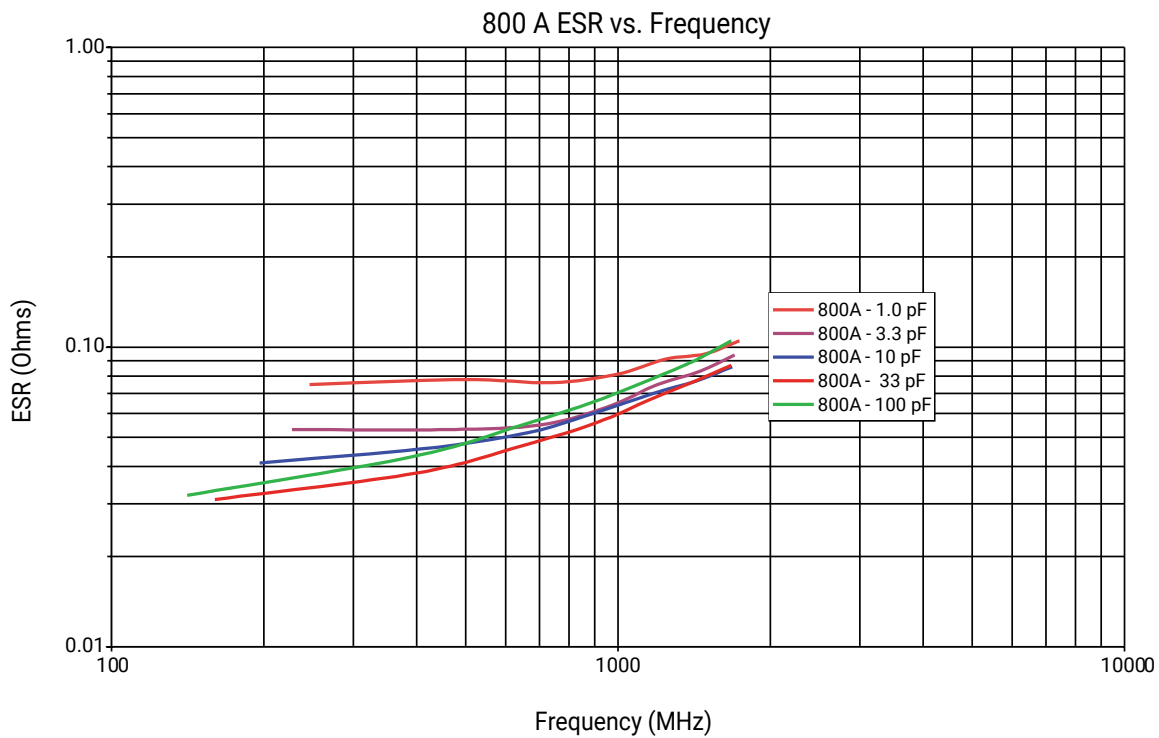

PERFORMANCE DATA

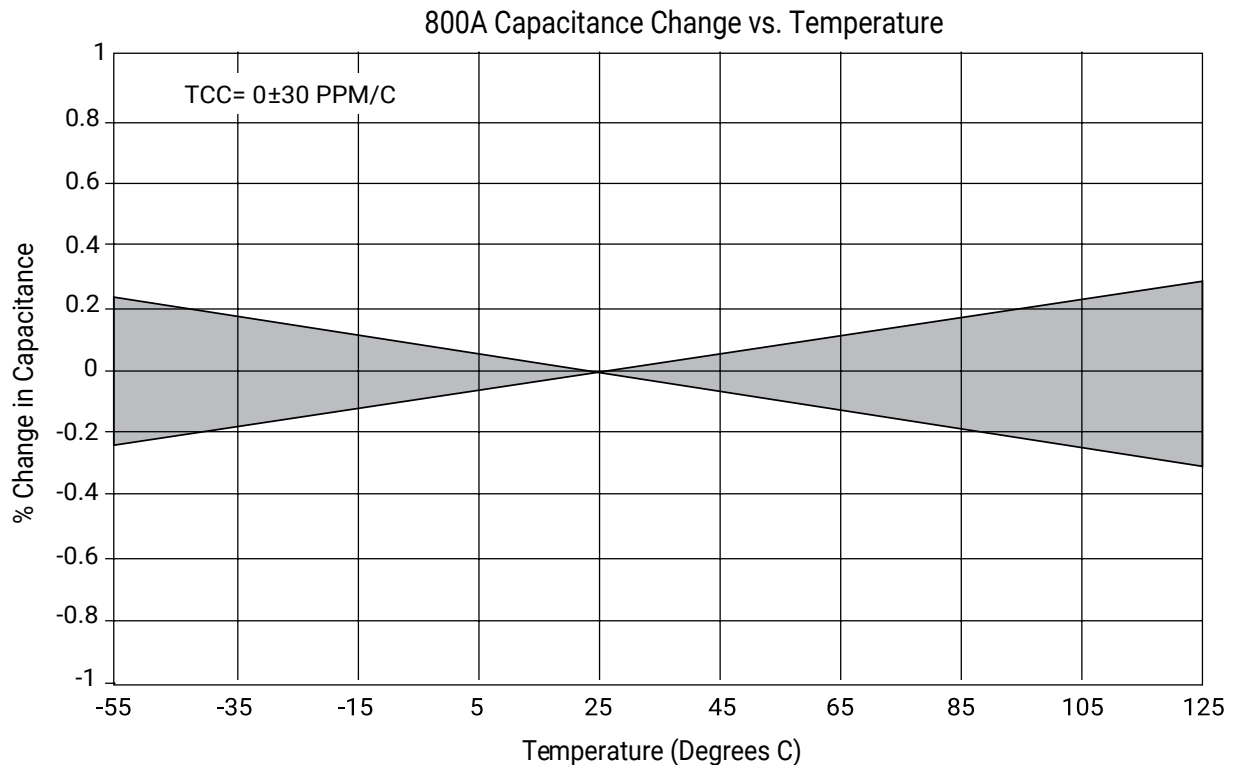
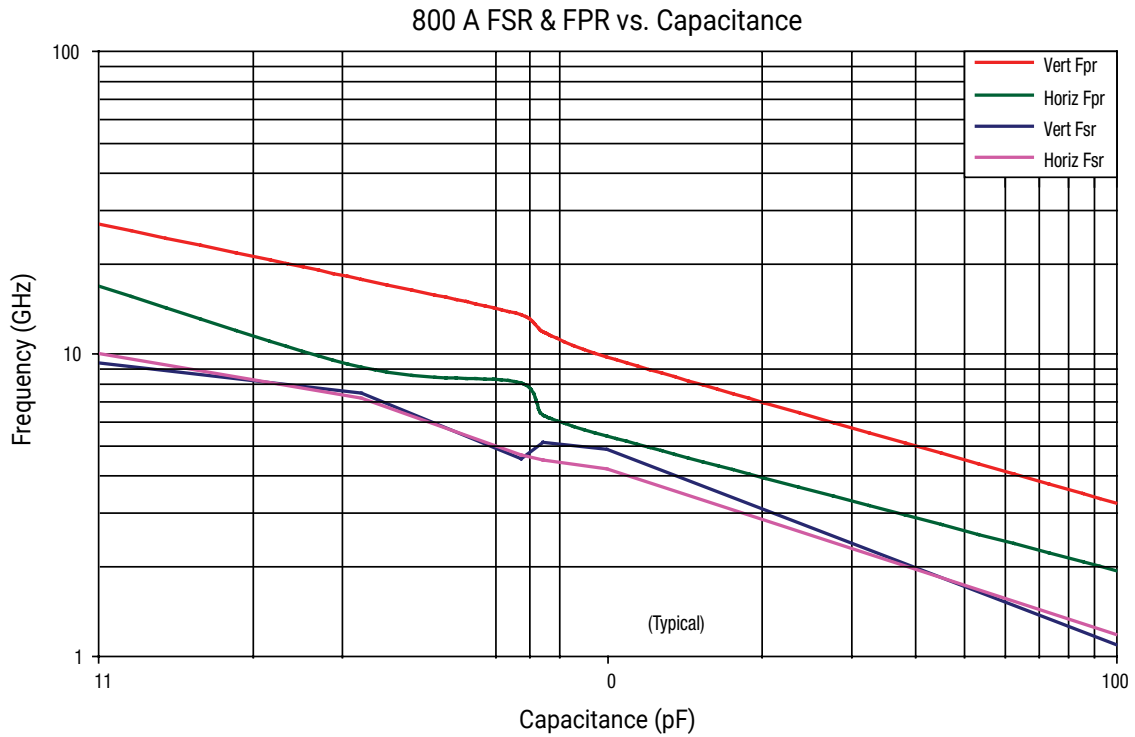

RF/Microwave Capacitors

RF/Microwave Multilayer Capacitors (MLC)

800A Series NP0 Porcelain, High RF Power Ultra-Low ESR



SAMPLE KITS

Kit #	RoHS Compliant	Item Number	Description	Cap. Value Range (pF)	Cap Value (pF)	Tol.	Price
Kit 80T		DK0080T	800A NP0 Ceramic High RF Power MLCs 16 different values, 15 pcs. min. per value	0.1 to 2.0	0.1, 0.2, 0.3, 0.4, 0.5, 0.6, 0.7, 0.8, 0.9, 1.0, 1.1, 1.2, 1.5 ±0.1 1.6, 1.8, 2.0	±0.1 ±0.25	\$135.00
Kit 81T		DK0081T	800A NP0 Ceramic High RF Power MLCs 16 different values, 15 pcs. min. per value	1.0 to 10	1.0, 1.2, 1.5, 1.8, 2.0, 2.2, 2.4, 2.7, 3.0, 3.3..... 3.9, 4.7, 5.6, 6.8, 8.2	±0.1 ±0.25	\$135.00
Kit 82T		DK0082T	800A NP0 Ceramic High RF Power MLCs 16 different values, 15 pcs. min. per value	10 to 100	10, 12, 15, 18, 20, 22, 24, 27, 30, 33, 39, 47, 56, 68, 82, 100	±5%	\$135.00

RF/Microwave Capacitors

RF/Microwave Multilayer Capacitors (MLC)

800B Series NPO Porcelain, High RF Power Ultra-Low ESR

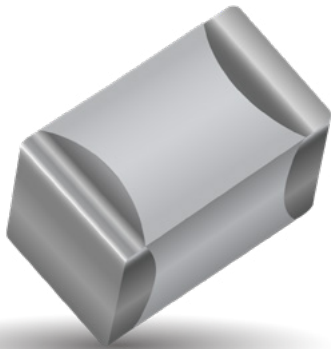

FEATURES

- Case B Size (.110" x .110")
- Rugged, reliable NPO dielectric
- Case optimized for highest self resonant frequency
- Capacitance Range 0.1 pF to 1000 pF
- Lowest ESR
- Capable of highest RF Power
- RoHS Compliant/Lead-Free

PACKAGING OPTIONS

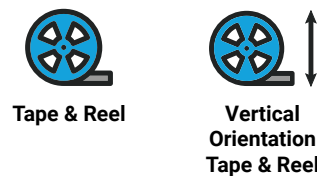

GENERAL DESCRIPTION

KYOCERA AVX's 800B Series offers superb performance in demanding high RF power applications requiring consistent and reliable operation. The combination of highly conductive metal electrode systems, optimized case geometries, and proprietary dielectrics, yields the lowest ESR. KYOCERA AVX's new NPO low loss rugged dielectrics are designed to provide superior heat transfer in high RF power applications. Ultra-low ESR and superior thermal performance insure that the 800B Series products are your best choice for high RF power applications from VHF through microwave frequencies.

TYPICAL APPLICATIONS

- Avionics
- Public Safety Radio
- Wireless Communications
- VHF / UHF / HDTV Broadcast Transmitters
- Telecom
- WiMAX
- Microwave Communication Systems and Satellite Systems

TYPICAL CIRCUIT APPLICATIONS

- High RF Power Filter Networks
- Matching Networks
- Couplers
- Combiners
- Output Coupling
- Antenna Coupling
- DC Blocking
- Bypassing

ENVIRONMENTAL TEST

Thermal Shock	MIL-STD-202, Method 107, Condition A
Moisture Resistance	MIL-STD-202, Method 106
Low Voltage Humidity	MIL-STD-202, Method 103, Condition A, with 1.5 Volts DC applied while subjected to an environment of 85°C with 85% relative humidity for 240 hours min.
Life Test	MIL-STD-202, Method 108, for 2000 hours, at 125°C 200% WVDC applied

ENVIRONMENTAL CHARACTERISTICS

Quality Factor (Q)	> 2000 @ 1 MHz
Temperature Coefficient of Capacitance (TCC)	0 ±30 PPM/°C (-55°C to +125°C)
Insulation Resistance (IR)	0.1 pF to 1000 pF: 10 ⁵ Megohms min. @ +25°C at rated WVDC 10 ⁴ Megohms min. @ +125°C at rated WVDC
Working Voltage (WVDC)	See Capacitance Values Table
Dielectric Withstanding Voltage (DWV)	Case B: 250% of rated WVDC for 5 secs
Retrace	Less than ±(0.02% or 0.02 pF), whichever is greater
Aging Effects	None
Piezoelectric Effects	None
Capacitance Drift	±(0.02% or 0.02 pF), whichever is greater
Operating Temperature Range	From -55°C to +125°C (No derating of working voltage)
Termination Styles	See Mechanical Configurations
Terminal Strength	Terminations for chips withstand a pull of 5 lbs. min., 15 lbs. typical, for 5 seconds in direction perpendicular to the termination surface of the capacitor. Test per MIL-STD-202, method 211.



RF/Microwave Capacitors

RF/Microwave Multilayer Capacitors (MLC)

800B Series NP0 Porcelain, High RF Power Ultra-Low ESR



CAPACITANCE VALUES

Cap. Code	Cap. (pF)	Tol.	Rated WVDC	Cap. Code	Cap. (pF)	Tol.	Rated WVDC	Cap. Code	Cap. (pF)	Tol.	Rated WVDC	Cap. Code	Cap. (pF)	Tol.	Rated WVDC
0R1	0.1	B	500	2R4	2.4	B, C, D	500	200	20	F, G, J, K, M	500	151	150	F, G, J, K, M	300
0R2	0.2			2R7	2.7			220	22			161	160		
0R3	0.3	B, C		3R0	3.0			240	24			181	180		
0R4	0.4			3R3	3.3			270	27			201	200		
0R5	0.5	B, C, D		3R6	3.6			300	30			221	220		
0R6	0.6			3R9	3.9			330	33			241	240		
0R7	0.7			4R3	4.3			360	36			271	270		
0R8	0.8			4R7	4.7			390	39			301	300		
0R9	0.9			5R1	5.1			430	43			331	330		
1R0	1.0			5R6	5.6			470	47			361	360		
1R1	1.1			B, C, D	6R2			6.2	510			51	391		390
1R2	1.2				6R8			6.8	560			56	431		430
1R3	1.3		7R5		7.5	620	62	471	470						
1R4	1.4		B, C, D		8R2	8.2	680	68	511	510					
1R5	1.5				9R1	9.1	750	75	561	560					
1R6	1.6		B, C, D		100	10	820	82	621	620					
1R7	1.7	110			11	910	91	681	680						
1R8	1.8	120			12	101	100	751	750						
1R9	1.9	B, C, D			130	13	111	110	821	820					
2R0	2.0				150	15	121	120	911	910					
2R1	2.1	B, C, D			160	16	131	130	102	1000					
2R2	2.2				180	18									

VRMS = 0.707 X WVDC

• SPECIAL VALUES, TOLERANCES AND MATCHING AVAILABLE. PLEASE CONSULT FACTORY.

HOW TO ORDER

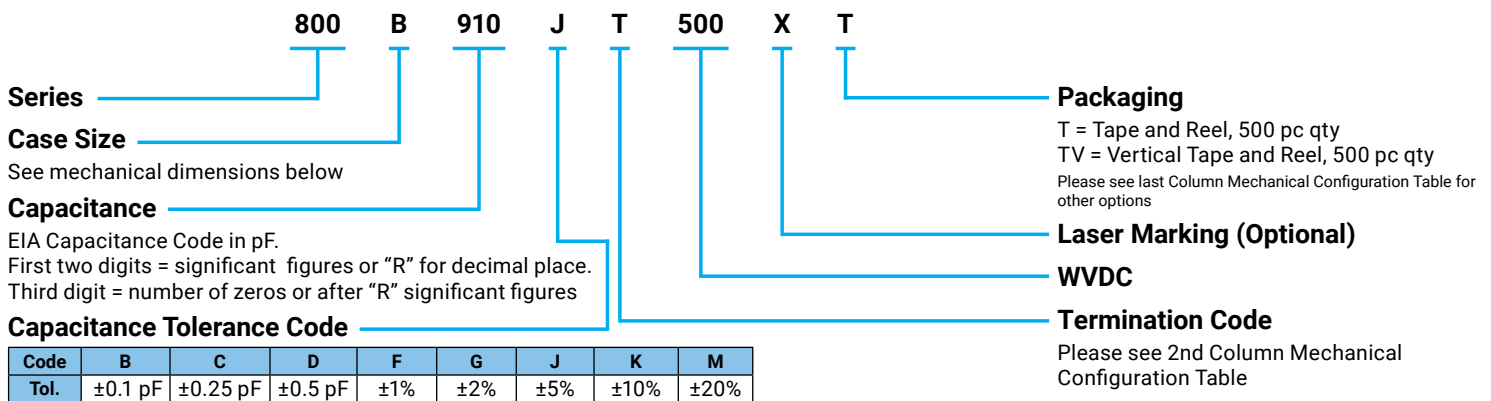

The above part number refers to a 800 B Series (case size B) 91 pF capacitor, J tolerance (±5%), 500 WVDC, with T termination (Tin Plated over Nickel Barrier Termination, RoHS Compliant), laser marking and tape and reel packaging.

RF/Microwave Capacitors

RF/Microwave Multilayer Capacitors (MLC)

800B Series NP0 Porcelain, High RF Power Ultra-Low ESR



MECHANICAL CONFIGURATION

Series & Case Size	Term. Code	Case Size & Type	Outline ES W/T is a Termination Surface	Body Dimensions inches (mm)			Lead and Termination Dimensions and Material		Pkg Type & Qty	Pkg Code
				Length (L)	Width (W)	Thickness (T)	Overlap (Y)	Materials		
800B	T	B Solderable Nickel Barrier		.110+.020-.010 (2.79+0.51-0.25)	.110 ±.015 (2.79 ±0.38)	.070 (1.78) max.	.015 (0.38) ±.010 (0.25)	RoHS Compliant Tin Plated over Nickel Barrier Termination	T&R, 1000 or 500 pcs Vertical T&R, 1000 or 500 pcs	T1K or T TV1K or TV
800B	W	B Solder Plate		.110+.020-.010 (2.79+0.51-0.25)	.110 ±.015 (2.79 ±0.38)				Tin/ Lead, Solder Plated over Nickel Barrier Termination	T&R, 1000 or 500 pcs Vertical T&R, 1000 or 500 pcs

NON-MAGNETIC CONFIGURATION

Series & Case Size	Term. Code	Case Size & Type	Non-Magnetic Configuration	Body Dimensions inches (mm)			Lead and Termination Dimensions and Material		Pkg Type & Qty	Pkg Code
				Length (L)	Width (W)	Thickness (T)	Overlap (Y)	Materials		
800B	TN	B Non-Mag Solderable Barrier		.110+.020-.010 (2.79+0.51-0.25)	.110 ±.015 (2.79 ±0.38)	.070 (1.78) max.	.015 (0.38) ±.010 (0.25)	RoHS Compliant Tin Plated over Non-Magnetic Barrier Termination	T&R, 1000 or 500 pcs Vertical T&R, 1000 or 500 pcs	T1K or T TV1K or TV

SUGGESTED MOUNTING PAD DIMENSIONS

Horizontal Electrode Orientation

Vertical Electrode Orientation

Case B Vertical Mount					
Cap Value .43	Pad Size	A Min.	B Min.	C Min.	D Min.
All Values	Normal	.090 (2.29)	.050 (1.27)	.075 (1.91)	.175 (4.45)
	High Density	.070 (1.78)	.030 (.762)	.075 (1.91)	.135 (3.43)

inches (mm)

Case B Horizontal Mount					
Cap Value .43	Pad Size	A Min.	B Min.	C Min.	D Min.
All Values	Normal	.130 (3.30)	.050 (1.27)	.050 (1.27)	.175 (4.45)
	High Density	.110 (2.79)	.030 (.762)	.075 (1.91)	.135 (3.43)

inches (mm)

RF/Microwave Capacitors

RF/Microwave Multilayer Capacitors (MLC)

800B Series NP0 Porcelain, High RF Power Ultra-Low ESR



PERFORMANCE DATA

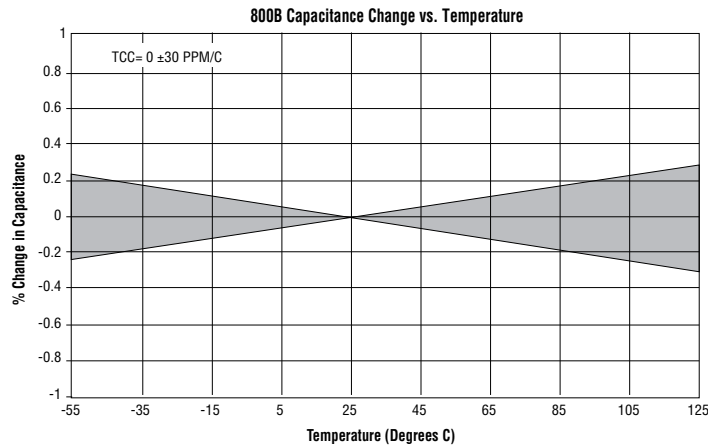
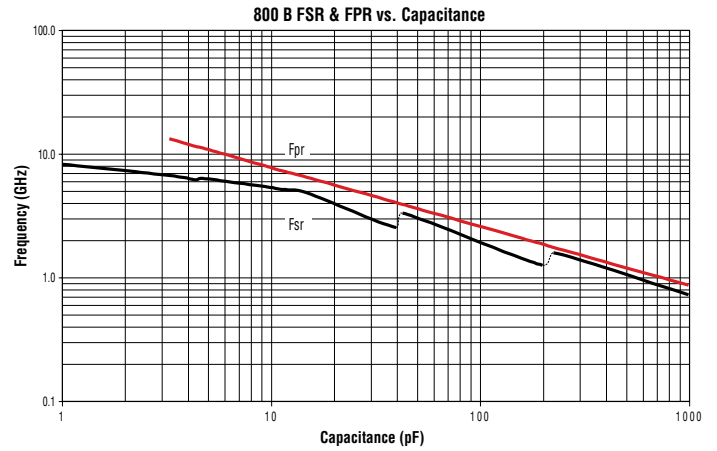
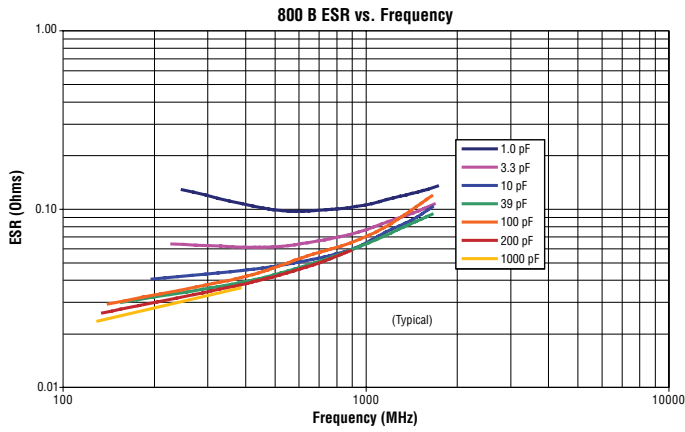

RF/Microwave Capacitors

RF/Microwave Multilayer Capacitors (MLC)

800B Series NPO Porcelain, High RF Power Ultra-Low ESR



SAMPLE KITS

Kit #	RoHS Compliant	Item Number	Description	Cap. Value Range (pF)	Cap Value (pF)	Tol.	Price
Kit 83T		DK0083T	800B NPO Ceramic High RF Power MLCs 16 different values, 15 pcs. min. per value	1.0 to 10	1.0, 1.2, 1.5, 1.8, 2.0, 2.2, 2.4, 2.7, 3.0, 3.3..... 3.9, 4.7, 5.6, 6.8, 8.2 10	±0.1 ±0.25 ±5%	\$165.00
Kit 84T		DK0084T	800B NPO Ceramic High RF Power MLCs 16 different values, 15 pcs. min. per value	10 to 100	10, 12, 15, 18, 20, 22, 24, 27, 30, 33, 39, 47, 56, 68, 82, 100	±0.1	\$165.00
Kit 85T		DK0085T	800B NPO Ceramic High RF Power MLCs 16 different values, 15 pcs. min. per value	100 to 1000	100, 120, 150, 180, 200, 220, 240, 270, 300, 330, 390, 470..... 560, 680, 820, 1000.....	±5% ±10%	\$165.00

RF/Microwave Capacitors

RF/Microwave Multilayer Capacitors (MLC)

800C Series NP0 Porcelain, High RF Power Ultra-Low ESR

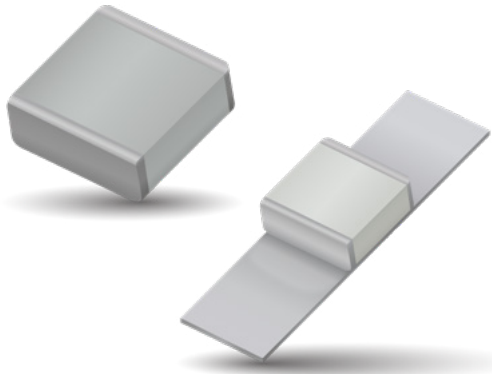

GENERAL DESCRIPTION

KYOCERA AVX's 800 C Series offers superb performance in demanding high RF power applications requiring consistent and reliable operation. The combination of highly conductive metal electrode systems, optimized case geometries, and proprietary dielectrics, yields the lowest ESR. KYOCERA AVX's new NP0 low loss rugged dielectrics are designed to provide superior heat transfer in high RF power applications. Ultra-low ESR and superior thermal performance ensure that the 800C Series products are your best choice for high RF power applications from VHF through microwave frequencies.

TYPICAL APPLICATIONS

- Bypass
- Coupling
- Tuning
- DC Blocking
- Impedance Matching

TYPICAL CIRCUIT APPLICATIONS

- HF/RF Power Amplifiers
- Transmitters
- Antenna Tuning
- Plasma Chambers
- Medical (MRI coils)

ENVIRONMENTAL TEST

Thermal Shock	MIL-STD-202, Method 107, Condition A.
Moisture Resistance	MIL-STD-202, Method 106.
Low Voltage Humidity	MIL-STD-202, Method 103, Condition A, with 1.5 Volts DC applied while subjected to an environment of 85°C with 85% relative humidity for 240 hours min.
Life Test	MIL-STD-202, Method 108, for 2000 hours, at 125°C. Voltage applied. 200% of WVDC for capacitors rated at 500 volts DC or less. 120% of WVDC for capacitors rated at 1250 volts DC or less. 100% of WVDC for capacitors rated above 1250 volts DC.

FEATURES

- Case C Size (.250" x .250")
- High Q
- Low ESR/ESL
- High RF Power
- 3600 WVDC
- Capacitance Range: 2.2 pF to 3000 pF
- Ultra-Stable Performance
- High RF Current/Voltage
- High Reliability
- RoHS Compliant, Pb free

PACKAGING OPTIONS



Tape & Reel



Tray
(180 pcs)



ENVIRONMENTAL CHARACTERISTICS

Quality Factor (Q)	Greater than 5,000 (2.2 pF to 1000 pF) @ 1 MHz. Greater than 5,000 (1100 pF to 3000 pF) @ 1 KHz.
Temperature Coefficient of Capacitance (TCC)	0 ±30 PPM/°C (-55°C to +125°C)
Insulation Resistance (IR)	2.2 pF to 3000 pF: 10 ⁵ Megohms min. @ +25°C at rated WVDC. 10 ⁴ Megohms min. @ +125°C at rated WVDC. Max. test voltage is 500 VDC.
Working Voltage (WVDC)	See Capacitance Values Table
Dielectric Withstanding Voltage (DWV)	250% of WVDC for capacitors rated at 500 volts DC or less for 5 seconds. 150% of WVDC for capacitors rated above 500 volts DC and ≤1250 volts DC for 5 seconds. 120% of WVDC for capacitors rated above 1250 volts DC for 5 seconds.
Retrace	Less than ±(0.02% or 0.02 pF), whichever is greater.
Aging Effects	None
Piezoelectric Effects	None
Capacitance Drift	±(0.02% or 0.02 pF), whichever is greater.
Operating Temperature Range	From -55°C to +125°C (No derating of working voltage).
Termination Styles	See Mechanical Configurations
Terminal Strength	Terminations for chips withstand a pull of 10 lbs. min., 20 lbs. typical, for 5 seconds in direction perpendicular to the termination surface of the capacitor. Test per MIL-STD-202, method 211.

RF/Microwave Capacitors

RF/Microwave Multilayer Capacitors (MLC)

800C Series NP0 Porcelain, High RF Power Ultra-Low ESR



CAPACITANCE VALUES

CAP CODE	CAP (pF)	TOL.	RATED WVDC	CAP CODE	CAP (pF)	TOL.	RATED WVDC	CAP CODE	CAP (pF)	TOL.	RATED WVDC
2R2	2.2	B, C, D	3600	240	24	F, G, J, K	3600	241	240	F, G, J, K	1000
2R4	2.4			270	27			271	270		
2R7	2.7			300	30			301	300		
3R0	3.0			330	33			331	330		
3R3	3.3			360	36			361	360		
3R6	3.6			390	39			391	390		
3R9	3.9			430	43			431	430		
4R3	4.3			470	47			471	470		
4R7	4.7			510	51			511	510		
5R1	5.1			560	56			561	560		
5R6	5.6	620	62	621	620						
6R2	6.2	F, G, J, K	3600	680	68	F, G, J, K	2500	681	680	F, G, J, K	600
6R8	6.8			750	75			751	750		
7R5	7.5			820	82			821	820		
8R2	8.2			910	91			911	910		
9R1	9.1			101	100			102	1000		
100	10			111	110			112	1100		
110	11			121	120			122	1200		
120	12			131	130			152	1500		
130	13			151	150			182	1800		
150	15			161	160			222	2200		
160	16	181	180	242	2400						
180	18	201	200	272	2700						
200	20	221	220	302	3000						
220	22										

HOW TO ORDER

800 C 220 J TN 3600 X T

Series ————
Case Size ————
 See mechanical dimensions below
Capacitance ————
 EIA Capacitance Code in pF.
 First two digits = significant figures or "R" for decimal place.
 Third digit = number of zeros or after "R" significant figures
Capacitance Tolerance Code ————

Code	B	C	D	F	G	J	K
Tol.	±0.1 pF	±0.25 pF	±0.5 pF	±1%	±2%	±5%	±10%

Termination Code ————
 Please see 2nd Column Mechanical Configuration Table
Packaging ————
 T = Tape and Reel, 500 pc. qty.
 Surface Mount Termination Only
 Please see last Column Mechanical Configuration Table for other options
Laser Marking (Optional) ————
WVDC ————
Termination Code ————
 Please see 2nd Column Mechanical Configuration Table

The above part number refers to a 800 C Series (case size C) 22 pF capacitor, J tolerance (±5%), 3600 WVDC, with TN termination (RoHS Compliant, Tin Plated over Non-Magnetic Barrier Termination), laser marking and T&R packaging.

RF/Microwave Capacitors

RF/Microwave Multilayer Capacitors (MLC)

800C Series NP0 Porcelain, High RF Power Ultra-Low ESR



MECHANICAL CONFIGURATIONS

Series & Case Size	Term. Code	Case Size & Type	Outlines W/T Is A Termination Surface	Body Dimensions Inches (mm)			Lead And Termination Dimensions And Materials			
				Length (L)	Width (W)	Thickness (T)	Overlap (Y)	Materials	Pkg Type	Pkg Code
800C	T	Solderable Barrier		230+.025-.010 (5.84+0.64-0.25)	250 ±.015 (6.35 ±0.38)	.200 (5.08) max.	.040 (1.02) max.	RoHS Compliant Tin Plated over Nickel Barrier Termination	T&R, 250 or 500 pcs Tray, 36 or 180 pcs	T250 or T J36 or J180
800C	MS	Microstrip		245 ±.025 (6.22 ±0.64)				High Purity Silver Leads $L_L = .500$ (12.7) min. $W_L = .240 \pm .005$ (6.10 ±.127) $T_L = .004 \pm .001$ (.102 ±.025) Leads are Attached with High Temperature Solder	Tray, 24 or 60 pcs	J24 or J60
800C	AR	Axial Ribbon								

Custom lead styles and lengths are available; consult factory. All leads are high purity silver attached with high temperature solder and are RoHS compliant.

** $W_L = .110$ (2.79) for capacitance values ≤ 680 pF; $W_L = .130$ (3.30) for capacitance values > 680 pF

NON-MAGNETIC MECHANICAL CONFIGURATIONS

Series & Case Size	Term. Code	Case Size & Type	Outlines W/T is a Termination Surface	Body Dimensions Inches (mm)			Lead and Termination Dimensions And Materials			
				Length (L)	Width (W)	Thickness (T)	Overlap (Y)	Materials	Pkg Type	Pkg Code
800C	TN	Non-Mag Solderable Barrier.		230+.025-.010 (5.84+0.64-0.25)	50 ±.015 (6.35 ±0.38)	.200 (5.08) max.	.040 (1.02) max.	RoHS Compliant Tin Plated over Non-Magnetic Barrier Termination	T&R, 250 or 500 pcs Tray, 36 or 180 pcs	T250 or T J36 or J180
800C	MN	Non-Mag Microstrip245		±.025 (6.22 ±0.64)				High Purity Silver Leads $L_L = .500$ (12.7) min. $W_L = .240 \pm .005$ (6.10 ±.127) $T_L = .004 \pm .001$ (.102 ±.025) Leads are Attached with High Temperature Solder	Tray, 24 or 60 pcs	J24 or J60
800C	AN	Non-Mag Axial Ribbon		245 ±.025 (6.22 ±0.64)						

RF/Microwave Capacitors

RF/Microwave Multilayer Capacitors (MLC)

800C Series NP0 Porcelain, High RF Power Ultra-Low ESR



SUGGESTED MOUNTING PAD DIMENSIONS

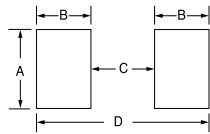
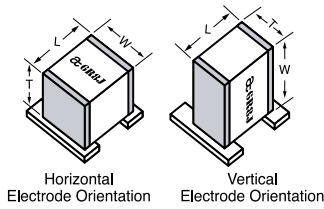

Case C Vertical Mount					
Cap Value	Pad Size	A Min.	B Min.	C Min.	D Min.
All Values	Normal	.200	.050	.200	.300
	High Density	.180	.030	.200	.260

Case C Horizontal Mount					
Cap Value	Pad Size	A Min.	B Min.	C Min.	D Min.
All Values	Normal	.280	.050	.200	.300
	High Density	.260	.030	.200	.260

Dimensions are in inches.

PERFORMANCE DATA

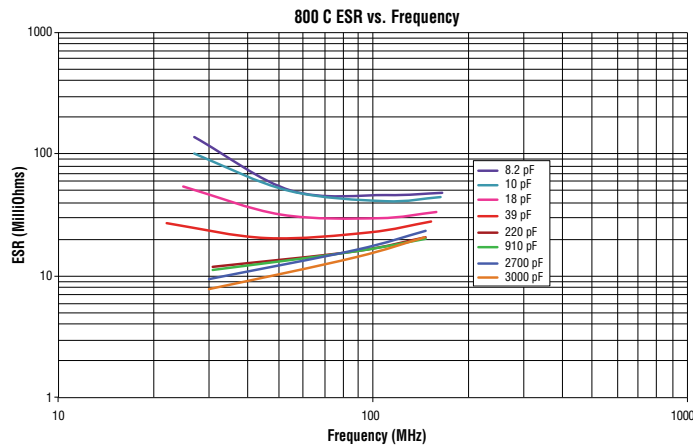
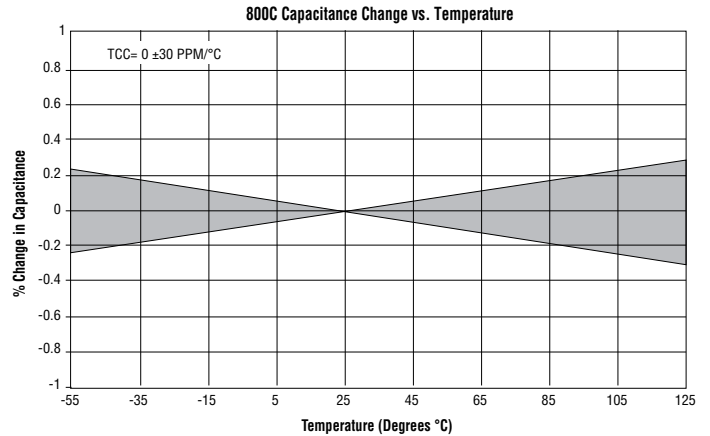
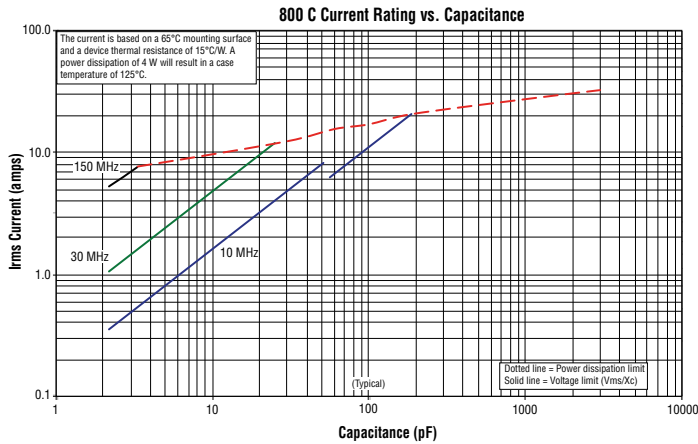

RF/Microwave Capacitors

RF/Microwave Multilayer Capacitors (MLC)

800E Series NPO Ceramic High RF Power Multilayer Capacitors

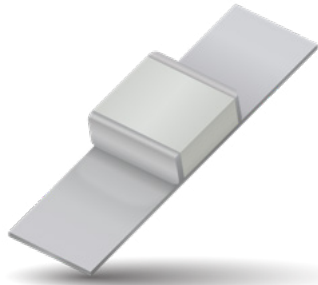

FEATURES

- Case E Size (.380" x .380")
- Capacitance Range 3.3 pF to 5100 pF
- Ultra Low ESR
- High Q
- High RF Power
- Ultra-Stable Performance
- High RF Current/Voltage
- High Reliability

GENERAL DESCRIPTION

KYOCERA AVX's 800 E Series offers superb performance in demanding high RF power applications requiring consistent and reliable operation. The combination of highly conductive metal electrode systems, optimized case geometries, and proprietary dielectrics, yields the lowest ESR. KYOCERA AVX's new NPO low loss rugged dielectrics are designed to provide superior heat transfer in high RF power applications. Ultra-low ESR and superior thermal performance ensure that the 800 E Series products are your best choice for high RF power applications from VHF through microwave frequencies.

FUNCTIONAL APPLICATIONS

- Bypass
- Impedance Matching
- Coupling
- DC Blocking
- Tuning

CIRCUIT APPLICATIONS

- HF/RF Power Amplifiers
- Plasma Chambers
- Transmitters
- Medical (MRI coils)
- Antenna Tuning

ENVIRONMENTAL CHARACTERISTICS

Thermal Shock	Mil-STD-202, Method 107, Condition A
Moisture Resistance	Mil-STD-202, Method 106
Low Voltage Humidity	Mil-STD-202, Method 103, condition A, with 1.5 VDC applied while subjected to an environment of 85°C with 85% relative humidity for 240 hours
Life Test	MIL-STD-202, Method 108, for 2000 hours, at 125°C. Voltage applied. 120% of WVDC for capacitors rated at 1250 volts DC or less. 100% of WVDC for capacitors rated above 1250 volts DC
Termination Styles	Available in various surface mount and leaded styles. See Mechanical Configurations
Terminal Strength	Terminations for chips and pellets withstand a pull of 10 lbs. min., 25 lbs. typical, for 5 seconds in direction perpendicular to the termination surface of the capacitor. Test per MIL-STD-202, method 211.

PACKAGING OPTIONS



Tape & Reel



Tray
(96 pcs)



ELECTRICAL SPECIFICATIONS

Temperature Coefficient (TCC)	0 ±30 PPM/°C (-55°C to +125°C)
Capacitance Range	3.3 pF to 5100 pF
Operating Temperature	-55°C to +125°C
Quality Factor	Greater than 5,000 (3.3 pF to 1000 pF) @ 1 MHz. Greater than 5,000 (1100 pF to 5,100 pF) @ 1 KHz.
Insulation Resistance (IR)	Max Test Voltage is 500 VDC 10 ⁵ Megohms min. @ 25°C at 500 VDC 10 ⁴ Megohms min. @ 125°C at 500 VDC
Working Voltage (WVDC)	See Capacitance Values table
Dielectric Withstanding Voltage (DWV)	120% of WVDC for 5 seconds
Aging Effects	None
Piezoelectric Effects	None
Capacitance Drift	± (0.02% or 0.02 pF), whichever is greater
Retrace	Less than ±(0.02% or 0.02 pF), whichever is greater.



The Important Information/Disclaimer is incorporated in the catalog where these specifications came from or available online at www.kyocera-avx.com/disclaimer/ by reference and should be reviewed in full before placing any order.

RF/Microwave Capacitors

RF/Microwave Multilayer Capacitors (MLC)

800E Series NPO Ceramic High RF Power Multilayer Capacitors



CAPACITANCE VALUES

Cap. Code	Cap. (pF)	Tol.	Rated WVDC	Cap. Code	Cap. (pF)	Tol.	Rated WVDC	Cap. Code	Cap. Code	Tol.	Rated WVDC
3R3	3.3	B, C, D	7200	360	36	F, G, J, K	7200	391	390	F, G, J, K	3600
3R6	3.6			390	39			431	430		
3R9	3.9			430	43			471	470		
4R3	4.3			470	47			511	510		
4R7	4.7			510	51			561	560		
5R1	5.1			560	56			621	620		
5R6	5.6			620	62			681	680		
6R2	6.2			680	68			751	750		
6R8	6.8			750	75			821	820		
7R5	7.5			820	82			911	910		
8R2	8.2	910	91	102	1000						
9R1	9.1	101	100	112	1100						
100	10	F, G, J, K	7200	111	110	F, G, J, K	3600	122	1200	F, G, J, K	2500
110	11			121	120			132	1300		
120	12			131	130			152	1500		
130	13			151	150			162	1600		
150	15			161	160			182	1800		
160	16			181	180			202	2000		
180	18			201	200			222	2200		
200	20			221	220			242	2400		
220	22			241	240			272	2700		
240	24			271	270			302	3000		
270	27	301	300	332	3300						
300	30	331	330	392	3900						
330	33	361	360	472	4700						
				512	5100						2000

VRMS = 0.707 X WVDC

• SPECIAL VALUES, TOLERANCES AND MATCHING AVAILABLE. PLEASE CONSULT FACTORY

HOW TO ORDER

Series **800** Case Size **E** Capacitance **220** Capacitance Tolerance Code **J** Termination **TN** Voltage Rating **7200** Laser Marking **X**** Packaging **T**

See mechanical dimensions below

EIA Capacitance Code in pF.
First two digits = significant figures or "R" for decimal place.
Third digit = number of zeros or after "R" significant figures

Please see 2nd Column Mechanical Configuration Table

Code	B	C	D	F	G	J	K	M
Tol.	±1 pF	±25 pF	±5 pF	±1%	±2%	±5%	±10%	±20%

**Optional

The above part number refers to a 800 E Series (case size E) 22 pF capacitor, J tolerance (±5%), 7200 WVDC, with TN termination (Tin Plated over Non-Magnetic Barrier Termination), laser marking and Tape and Reel Packaging. Add "D" instead of "X" for double-sided marking.







RF/Microwave Capacitors

RF/Microwave Multilayer Capacitors (MLC)

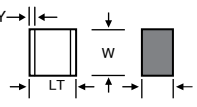
800E Series NPO Ceramic High RF Power Multilayer Capacitors

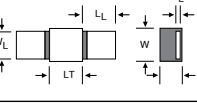

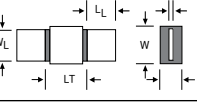

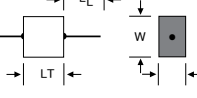

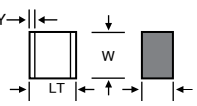

MECHANICAL CONFIGURATION

Series & Case Size	Term. Code	Case Size & Type	Outline W/T is a Termination Surface	Body Dimensions inches (mm)			Lead and Termination Dimensions and Material		Pkg Type	Pkg Code						
				Length (L)	Width (W)	Thickness (T)	Overlap (Y)	Materials								
800E	T	 Solderable Nickel Barrier		.380+.015-.010 (9.65+0.38-0.25)			.040 (1.02) max.	RoHS Compliant Tin Plated over Nickel Barrier Termination	T&R, 250 pcs Tray, 24 or 96 pcs	T J24 or J96						
800E	MS	 Microstrip									.380+.015-.010 (9.65+0.38-0.25)		.190 (4.83) max.	High Purity Silver Leads $L_L = .750$ (19.05) min $W_L = .350 \pm .010$ (8.89 \pm 0.25) $T_L = .010 \pm .005$ (0.25 \pm 0.13) Leads are Attached with High Temperature Solder.	Tray, 16 or 32 pcs	J16 or J32
800E	AR	 Axial Ribbon														
800E	AW	 Axial Wire												Silver-plated Copper Leads Dia. = $.032 \pm .002$ (.813 \pm .051) $L_L = 2.25$ (57.2) min.	Box, 20 pcs	B20

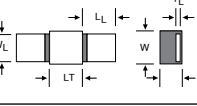
Custom lead styles and lengths are available; consult factory. All leads are high purity silver attached with high temperature solder and are **RoHS** compliant.

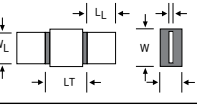
NON MECHANICAL CONFIGURATION

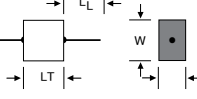
Series & Case Size	Term. Code	Case Size & Type	Outline W/T is a Termination Surface	Body Dimensions inches (mm)			Lead and Termination Dimensions and Material		Pkg Type	Pkg Code						
				Length (L)	Width (W)	Thickness (T)	Overlap (Y)	Materials								
800E	TN	 Non-Mag Solderable Barrier		.380+.015-.010 (9.65+0.38-0.25)			.040 (1.02) max.	RoHS Compliant Tin Plated over Non-Magnetic Barrier Termination	T&R, 250 pcs Tray, 24 or 96 pcs	T J24 or J96						
800E	MN	 Non-Mag Microstrip									.380 \pm .010 (9.65 \pm 0.25)	170 (4.32) max.	N/A	High Purity Silver Leads $L_L = .750$ (19.05) min $W_L = .350 \pm .010$ (8.89 \pm 0.25) $T_L = .010 \pm .005$ (0.25 \pm 0.13) Leads are Attached with High Temperature Solder.	Tray, 16 or 32 pcs	J16 or J32
800E	AN	 Non-Mag Axial Ribbon														
800E	BN	 Non-Mag Axial Wire												Silver-plated Copper Leads Dia. = $.032 \pm .002$ (.813 \pm .051) $L_L = 2.25$ (57.2) min.	Box, 20 pcs	B20

Custom lead styles and lengths are available; consult factory. All leads are high purity silver attached with high temperature solder and are **RoHS** compliant.

RF/Microwave Capacitors

RF/Microwave Multilayer Capacitors (MLC)

800E Series NPO Ceramic High RF Power Multilayer Capacitors



SUGGESTED MOUNTING PAD DIMENSIONS

Horizontal
Electrode Orientation

Vertical
Electrode Orientation

Mount Type	Case E				
	Pad Size	A Min.	B Min.	C Min.	D Min.
Vertical Mount	Normal	.185	.050	.325	.425
	High Density	.165	.030	.325	.385
Horizontal Mount	Normal	.405	.050	.325	.425
	High Density	.383	.030	.325	.385

Dimensions are in inches.

PERFORMANCE DATA

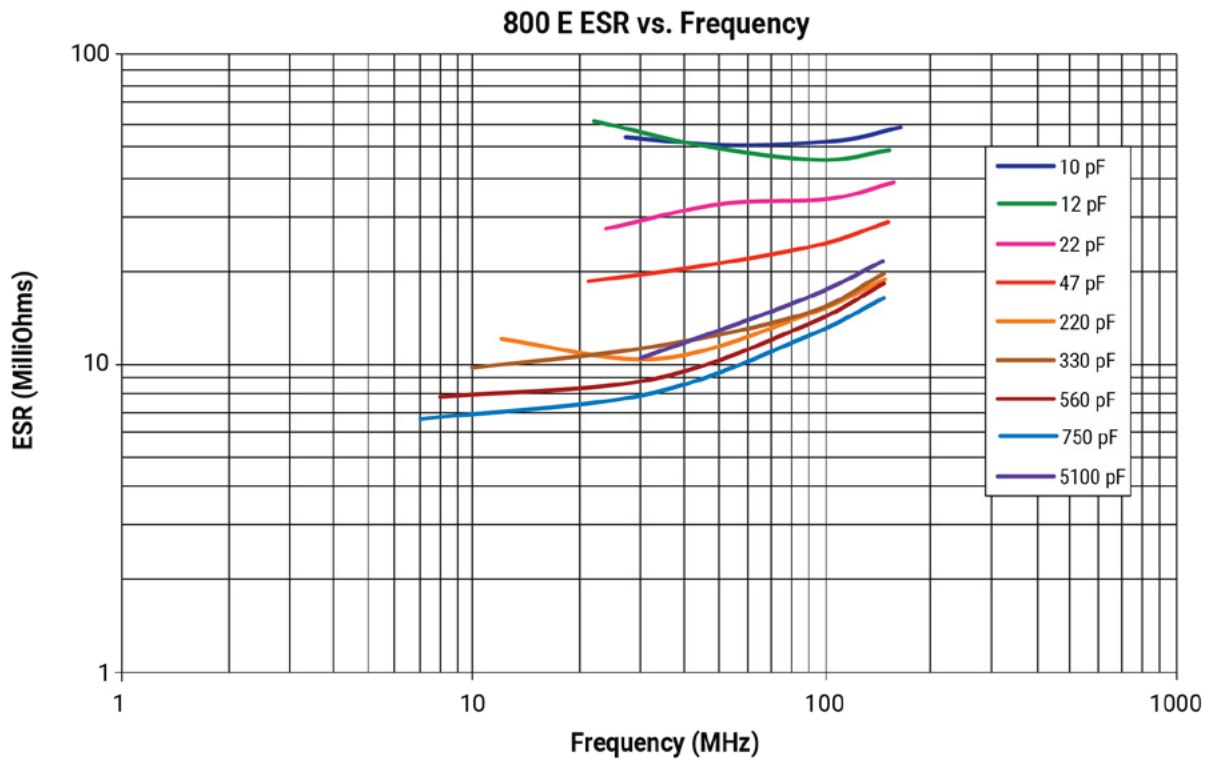

PERFORMANCE DATA

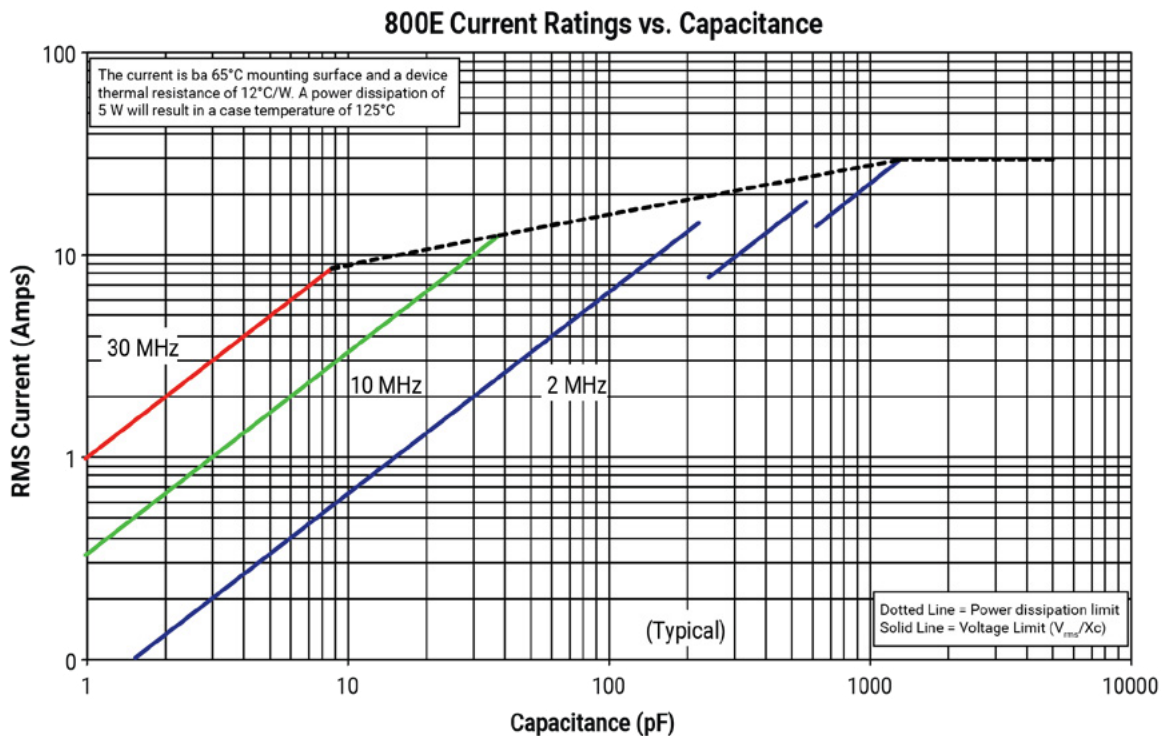
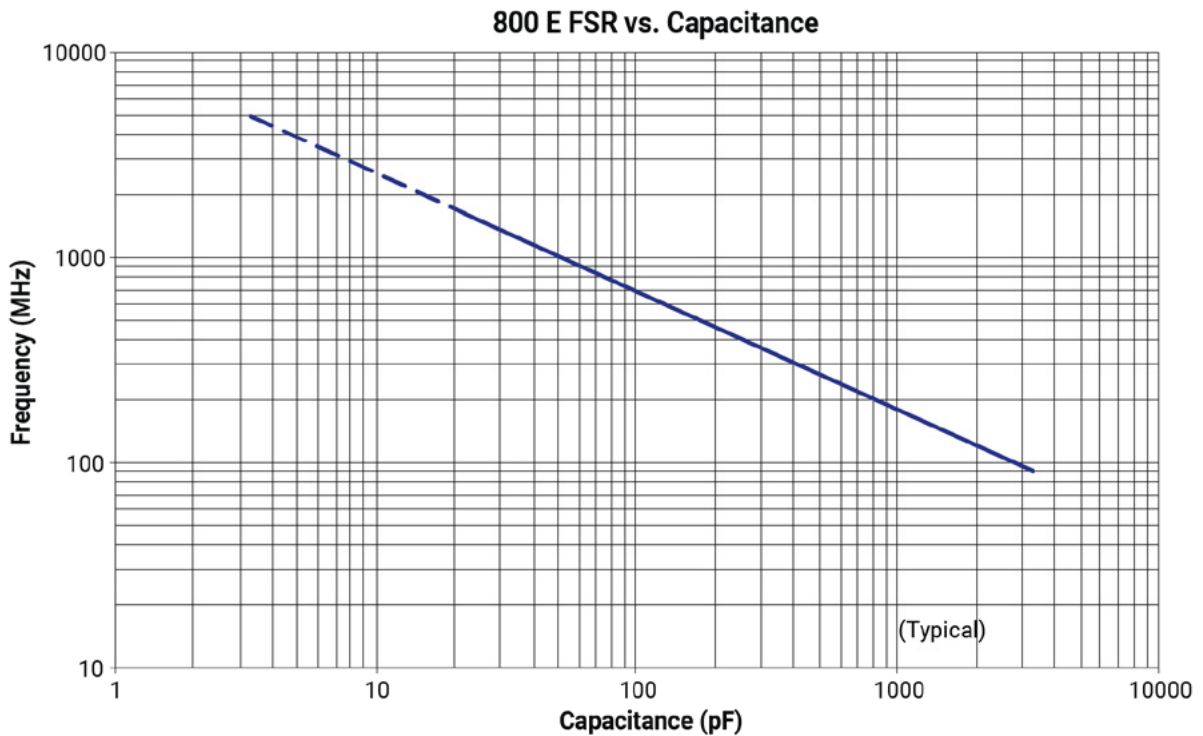

PERFORMANCE DATA

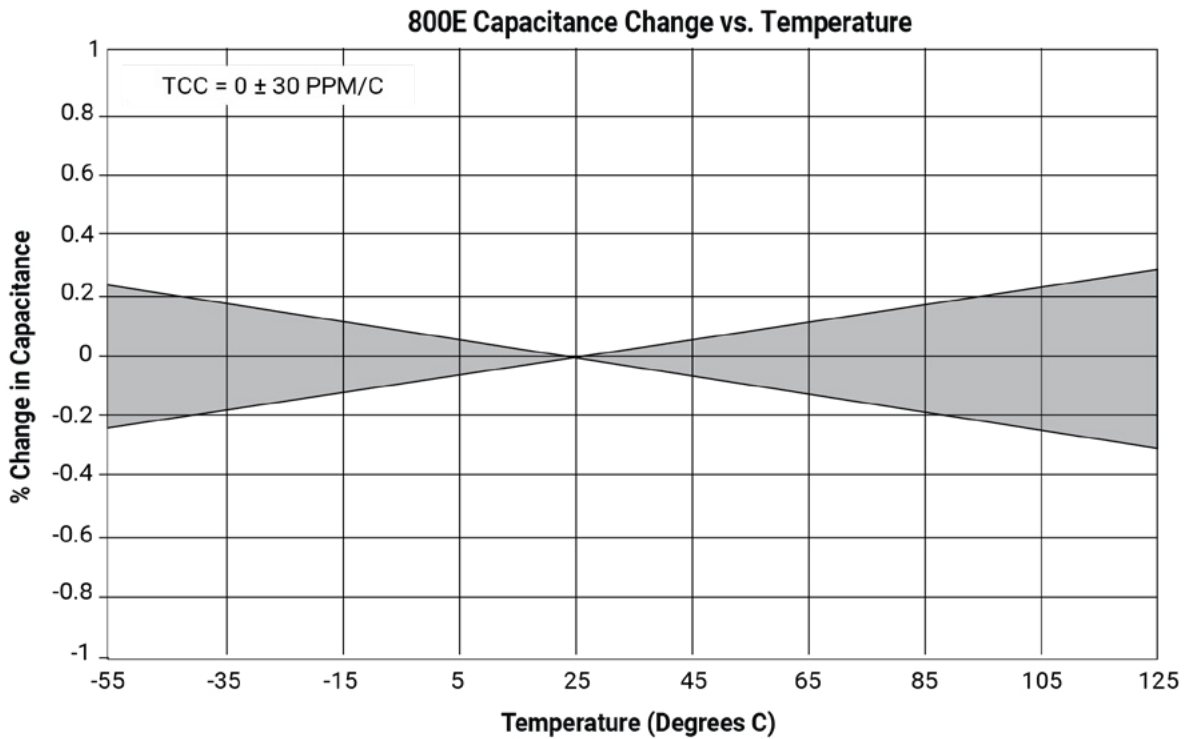

RF/Microwave Capacitors

RF/Microwave Multilayer Capacitors (MLC)

800H Series NPO Ceramic High RF Power Multilayer Capacitors

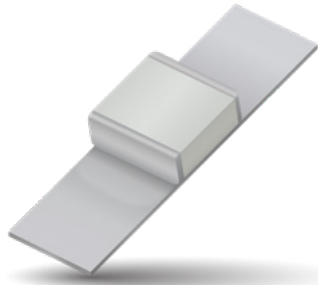

FEATURES

- Case H Size (.720" x .740")
- Capacitance Range 100 pF to 20,000 pF
- Ultra Low ESR
- High Q
- High RF Power
- Ultra-Stable Performance
- High RF Current/Voltage
- High Reliability

GENERAL DESCRIPTION

KYOCERA AVX's 800 H Series offers superb performance in demanding high RF power applications requiring consistent and reliable operation. The combination of highly conductive metal electrode systems, optimized case geometries, and proprietary dielectrics, yields the lowest ESR. KYOCERA AVX's new NPO low loss rugged dielectrics are designed to provide superior heat transfer in high RF power applications. Ultra-low ESR and superior thermal performance ensure that the 800 H Series products are your best choice for high RF power and High CV applications.

FUNCTIONAL APPLICATIONS

- Bypass
- Coupling
- Tuning
- Impedance Matching
- DC Blocking

CIRCUIT APPLICATIONS

- HF/RF Power Amplifiers
- Transmitters
- Antenna Tuning
- Inductive Heating
- Plasma Chambers
- Induction Charging Systems
- Medical (MRI coils)

ENVIRONMENTAL CHARACTERISTICS

Thermal Shock	MIL-STD-202, Method 107, Condition A
Moisture Resistance	MIL-STD-202, Method 106
Low Voltage Humidity	MIL-STD-202, Method 103, Condition A, with 1.5 Volts DC applied while subjected to an environment of 85°C with 85% relative humidity for 240 hours min.
Life Test	MIL-STD-202, Method 108, for 2000 hours, at 125°C at rated voltage.
Termination Styles	See Mechanical Configurations
Terminal Strength	Terminations for chips withstand a pull of 12 lbs. min., 20 lbs. typical, for 5 seconds in direction perpendicular to the termination surface of the capacitor. Test per MIL-STD-202, method 211.

PACKAGING OPTIONS



Tray
(4 pcs)



ELECTRICAL SPECIFICATIONS

Temperature Coefficient (TCC)	0 ±30 PPM/°C (-55°C to +125°C)
Capacitance Drift	±(0.02% or 0.02 pF), whichever is greater
Operating Temperature	From -55°C to +125°C
Quality Factor	Greater than 5000 (100 pF to 1000 pF) @ 1 MHz. Greater than 5000 (1100 pF to 20,000 pF) @ 1 KHz.
Insulation Resistance (IR)	Max Test Voltage is 500 VDC 10 ⁵ Megohms min. @ 25°C at 500 VDC 10 ⁴ Megohms min. @ 125°C at 500 VDC
Working Voltage (WVDC)	See Capacitance Values table
Dielectric Withstanding Voltage (DWV)	120% of WVDC for 5 seconds
Aging Effects	None
Piezoelectric Effects	None
Capacitance Drift	± (0.02% or 0.02 pF), whichever is greater
Retrace	Less than ±(0.02% or 0.02 pF), whichever is greater.

RF/Microwave Capacitors

RF/Microwave Multilayer Capacitors (MLC)

800H Series NPO Ceramic High RF Power Multilayer Capacitors



CAPACITANCE VALUES

CAP. CODE	CAP. (pF)	TOL.	RATED WVDC	CAP. CODE	CAP. (pF)	TOL.	RATED WVDC	CAP. CODE	CAP. (pF)	TOL.	RATED WVDC
101	100	G, J, K	8000	561	560	G, J, K	5000	332	3300	G, J, K	5000
111	110			621	620			392	3900		
121	120			681	680			472	4700		
131	130			751	750			512	5100		
151	150			821	820			562	5600		
161	160			911	910			622	6200		
181	180			102	1000			682	6800		
201	200			112	1100			752	7500		
221	220			122	1200			822	8200		
241	240			5000	5000			132	1300		
271	270	152	1500			103	10000				
301	300	162	1600			113	11000				
331	330	182	1800			123	12000				
361	360	202	2000			133	13000				
391	390	222	2200			153	15000				
431	430	242	2400			163	16000				
471	470	272	2700			183	18000				
511	510	302	3000			203	20000				

SPECIAL VALUES, TOLERANCES AND MATCHING AVAILABLE. PLEASE CONSULT FACTORY.

HOW TO ORDER

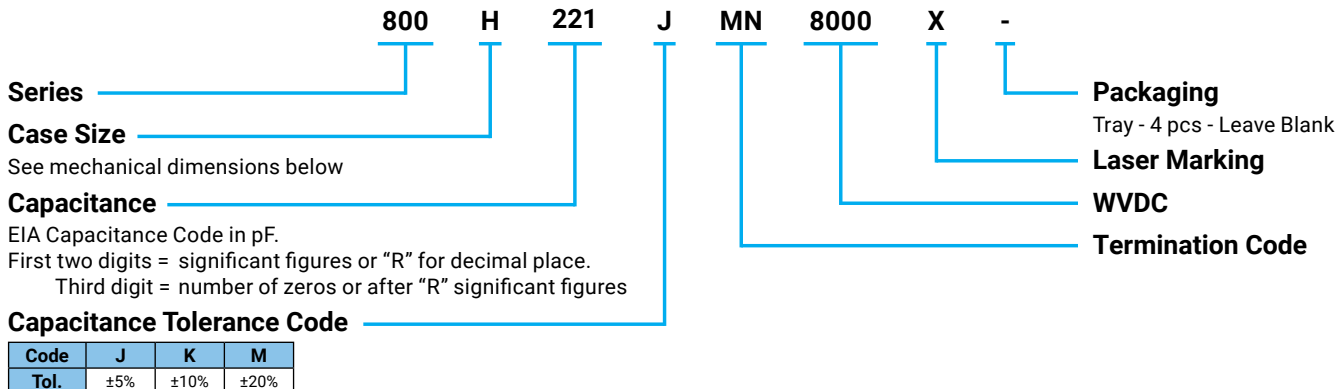

**Optional

The above part number refers to a 800 H Series (case size H) 220 pF capacitor, J tolerance (±5%), 8000 WVDC, with MN Non-Magnetic termination (Microstrip Termination), laser marking and Matrix Tray packaging.

RF/Microwave Capacitors

RF/Microwave Multilayer Capacitors (MLC)

800H Series NPO Ceramic High RF Power Multilayer Capacitors

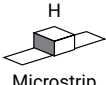
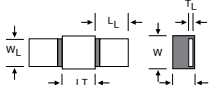

NON MECHANICAL CONFIGURATION

Series & Case Size	Term. Code	Case Size & Type	Outline W/T is a Termination Surface	Body Dimensions inches (mm)			Lead and Termination Dimensions and Material	
				Length (L)	Width (W)	Thickness (T)	Overlap (Y)	Materials
800H	MN	 Microstrip		.735±.060 -.010 (18.67±1.524 -.254)	.750±.020 -.010 (19.05±.508 -.254)	.220 (5.59) max.	N/A	High Purity Silver Leads L _L = .750 (19.05) min. W _L = .660 ±.010 (16.764±.254) T _L = .010 ±.001 (.254 ±.025) Leads are Attached with High Temperature Solder

Custom lead styles and lengths are available; consult factory. All leads are high purity silver attached with high temperature solder and are RoHS compliant.

PERFORMANCE DATA

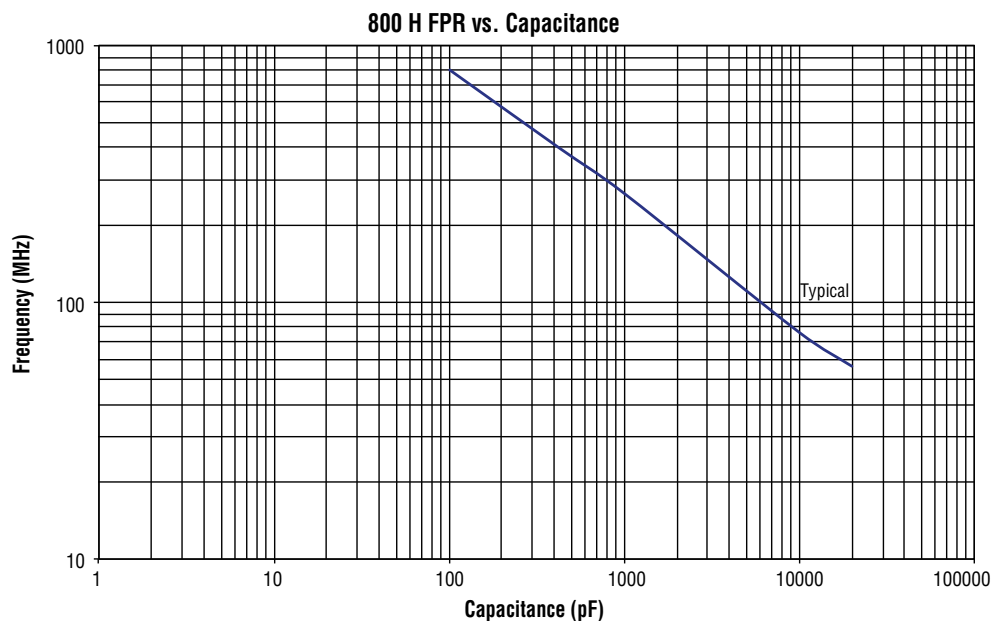
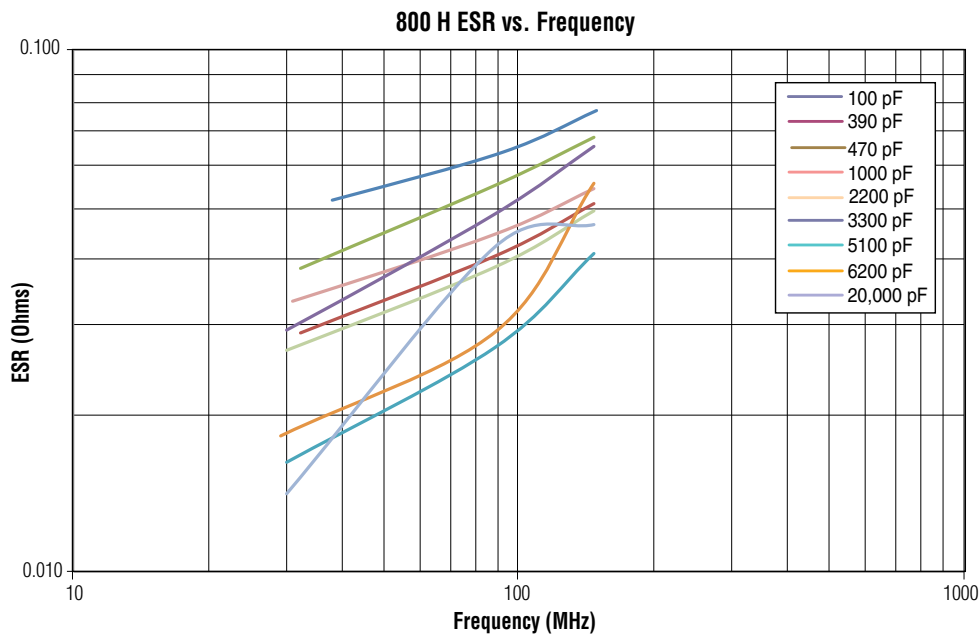

PERFORMANCE DATA

800 H Current vs Capacitance

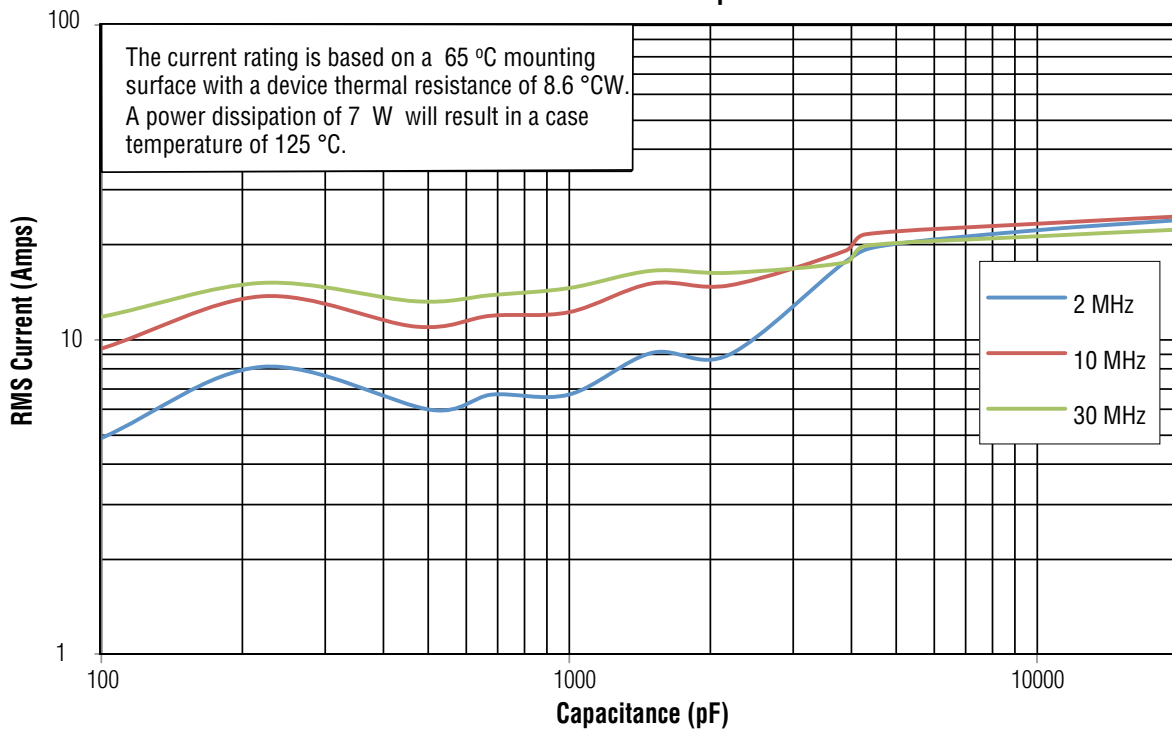

800 H Capacitance Change vs. Temperature

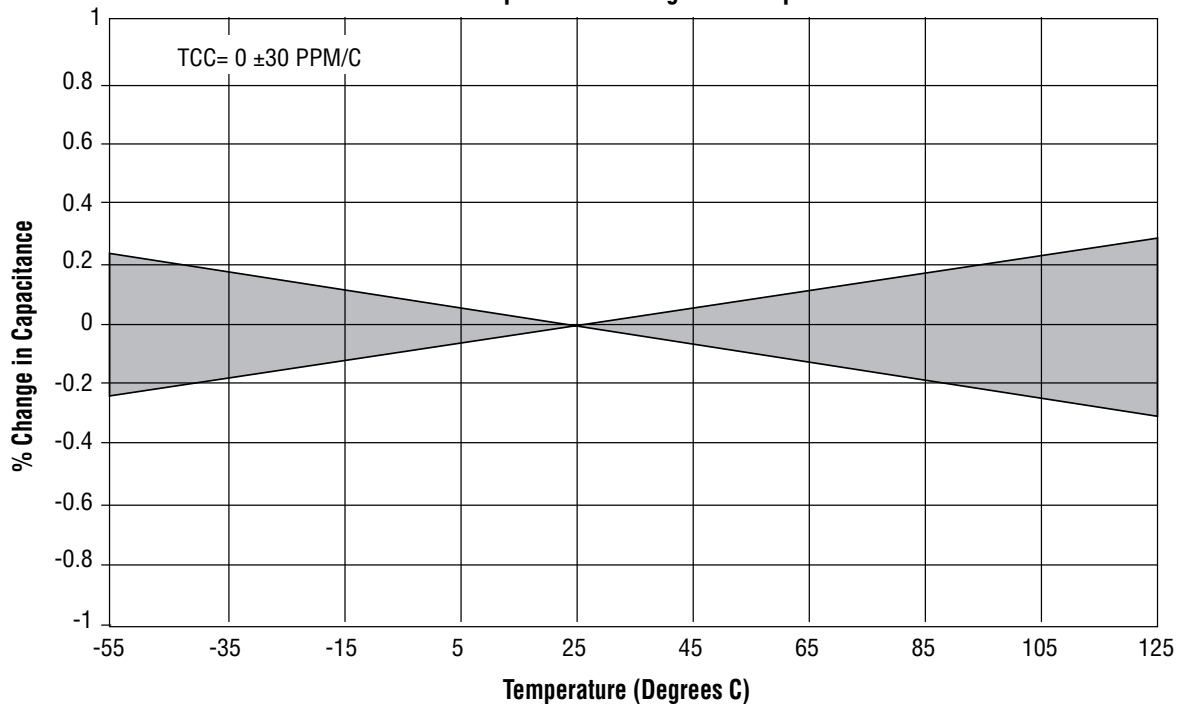

RF/Microwave Capacitors

RF/Microwave Multilayer Capacitors (MLC)

800R Series NPO Ceramic Ultra-Low ESR Multilayer Capacitors

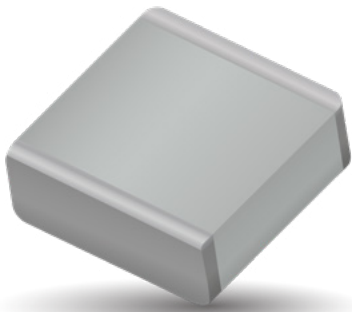

GENERAL DESCRIPTION

KYOCERA AVX's 800 R Series offers superb performance in demanding high RF power applications requiring consistent and reliable operation. The combination of optimized case geometry, highly conductive electrode formulations and proprietary dielectrics, yields the lowest ESR and superior heat transfer. KYOCERA AVX's new NPO low loss rugged dielectrics are designed to provide superior heat transfer in high RF power applications. Ultra-low ESR and superior thermal performance ensure that the 800 R Series products are your best choice for high RF power applications from UHF through microwave frequencies.

TYPICAL APPLICATIONS

- Homeland Security/Public Safety Radio (APCO-25)
- WiMAX/LTE*
- Satellite Systems
- Microwave Communications
- Digital HD FM Transmitters
- Avionics
- Digital HDTV Transmitters
- Medical Electronics

TYPICAL CIRCUIT APPLICATIONS

- High RF Power Filter Networks
- Matching Networks
- Output Coupling
- DC Blocking
- Combiners
- Couplers
- Antenna Coupling
- Bypassing

ENVIRONMENTAL TEST

Thermal Shock	MIL-STD-202, Method 107, Condition A.
Moisture Resistance	MIL-STD-202, Method 106.
Low Voltage Humidity	MIL-STD-202, Method 103, Condition A, with 1.5 Volts D.C. applied while subjected to an environment of 85°C with 85% relative humidity for 240 hours min.
Life Test	MIL-STD-202, Method 108, for 2000 hours, at 125°C 200% WVDC applied

FEATURES

- Case R Size (.070" x .090")
- Rugged, reliable NPO dielectric
- Optimized for highest self resonant frequency
- Capacitance Range 1 pF to 100 pF
- Capable of highest RF Power
- RoHS Compliant / Lead-Free
- Optimized for lowest ESR and superior heat transfer

PACKAGING OPTIONS



Tape & Reel



ENVIRONMENTAL CHARACTERISTICS

Quality Factor (Q)	> 2,000 @ 1 MHz
Temperature Coefficient of Capacitance (TCC)	0 ±30 PPM/°C (-55°C to +125°C)
Insulation Resistance (IR)	1 pF to 100 pF: 10 ⁹ Megohms min. @ +25°C at rated WVDC 10 ⁴ Megohms min. @ +125°C at rated WVDC
Working Voltage (WVDC)	500 WVDC
Dielectric Withstanding Voltage (DWV)	Case R: 250% of rated WVDC for 5 secs
Aging Effects	None
Piezoelectric Effects	None
Capacitance Drift	±(0.02% or 0.02 pF), whichever is greater
Operating Temperature Range	From -55°C to +125°C
Termination Styles	RoHS Compliant and Solder Plate See Mechanical Configurations
Terminal Strength	Terminations for chips withstand a pull of 5 lbs. min., 15 lbs. typical, for 5 seconds in direction perpendicular to the termination surface of the capacitor. Test per MIL-STD-202, Method 211.

RF/Microwave Capacitors

RF/Microwave Multilayer Capacitors (MLC)

800R Series NPO Ceramic Ultra-Low ESR Multilayer Capacitors



CAPACITANCE VALUES

Cap. Code	Cap. (pF)	Tol.	Rated WVDC	Cap. Code	Cap. (pF)	Tol.	Rated WVDC	Cap. Code	Cap. (pF)	Tol.	Rated WVDC
1R0	1.0	B, C, D	500	3R9	3.9	B, C, D	500	220	22	G, J K, M	500
1R1	1.1			4R3	4.3			240	24		
1R2	1.2			4R7	4.7			270	27		
1R3	1.3			5R1	5.1			300	30		
1R4	1.4			5R6	5.6			330	33		
1R5	1.5			6R2	6.2			360	36		
1R6	1.6			B, C, J, K, M	6R8	6.8		390	39		
1R7	1.7				7R5	7.5		430	43		
1R8	1.8				8R2	8.2		470	47		
1R9	1.9			9R1	9.1	510		51			
2R0	2.0			100	10	560		56			
2R1	2.1			110	11	620		62			
2R2	2.2			120	12	680		68			
2R4	2.4			130	13	750		75			
2R7	2.7			150	15	820		82			
3R0	3.0			160	16	910		91			
3R3	3.3			180	18	101		100			
3R6	3.6			200	20						

VRMS = 0.707 X WVDC
SPECIAL VALUES, TOLERANCES AND MATCHING AVAILABLE. PLEASE CONSULT FACTORY.

HOW TO ORDER

800 R 100 J T 500 X T

Series ————

Case Size ————
See mechanical dimensions below

Capacitance ————
EIA Capacitance Code in pF.
First two digits = significant figures or "R" for decimal place.
Third digit = number of zeros or after "R" significant figures

Capacitance Tolerance Code ————

Code	B	C	D	G	J	K	M
Tol.	±0.1 pF	±0.25 pF	±0.5 pF	±2%	±5%	±10%	±20%

Packaging ————
T = Tape and Reel, 500 pc.
TS = Electrodes in Horizontal Orientation
Tape and Reel: 500 pc.
Please see last Column Mechanical Configuration Table for other options

Laser Marking (Optional) ————

WVDC ————

Termination Code ————
Please see 2nd Column Mechanical Configuration Table

The above part number refers to a 800 R Series (case size R) 10 pF capacitor, J tolerance (±5%), 500 WVDC, with T termination (Tin Plated over Nickel Barrier, RoHS Compliant), laser marked, and tape and reel packaging.
*Consult ATC for other quantities.

RF/Microwave Capacitors

RF/Microwave Multilayer Capacitors (MLC)

800R Series NPO Ceramic Ultra-Low ESR Multilayer Capacitors



MECHANICAL CONFIGURATION

Series & Case Size	Term. Code	Case Size & Type	Outline ES W/T is a Termination Surface	Body Dimensions inches (mm)			Lead and Termination Dimensions and Material		Pkg Type & Qty	Pkg Code
				Length (L)	Width (W)	Thickness (T)	Overlap (Y)	Materials		
800R	T	R Solderable Nickel Barrier		.070 ±.015 (1.78±0.38)	.090 ±.010 (2.29±0.25)	.115 (2.92) max.	.010+.010 - .005 (0.25+0.25 - 0.13)	RoHS Compliant Tin Plated over Nickel Barrier Termination	T&R, 1000 or 500 pcs Horizontal T&R, 1000 or 500 pcs	T1K or T TS1K or TS
800R	W	R Solder Plate		.070 ±.015 (1.78±0.38)	.090 ±.010 (2.29±0.25)	.115 (2.92) max.	.010+.010 - .005 (0.25+0.25 - 0.13)	Tin/ Lead, Solder Plated over Nickel Barrier Termination	T&R, 1000 or 500 pcs Horizontal T&R, 1000 or 500 pcs	T1K or T TS1K or TS

NON-MAGNETIC CONFIGURATION

Series & Case Size	Term. Code	Case Size & Type	Non-Magnetic Configuration	Body Dimensions inches (mm)			Lead and Termination Dimensions and Material		Pkg Type & Qty	Pkg Code
				Length (L)	Width (W)	Thickness (T)	Overlap (Y)	Materials		
800R	TN	R Non-Mag Solderable Barrier		.070 ±.015 (1.78±0.38)	.090 ±.010 (2.29±0.25)	.115 (2.92) max.	.010+.010 - .005 (0.25+0.25 - 0.13)	RoHS Compliant Tin Plated over Non-Magnetic Barrier Termination	T&R, 1000 or 500 pcs Horizontal T&R, 1000 or 500 pcs	T1K or T TS1K or TS

SUGGESTED MOUNTING PAD DIMENSIONS

Horizontal Electrode Orientation

Vertical Electrode Orientation

Mount Type	Case R				
	Pad Size	A Min.	B Min.	C Min.	D Min.
Vertical Mount	Normal	.125	.050	.030	.130
	High Density	.115	.030	.030	.090
Horizontal Mount	Normal	.110	.050	.030	.130
	High Density	.090	.030	.030	.090

Dimensions are in inches.

RF/Microwave Capacitors

RF/Microwave Multilayer Capacitors (MLC)

800R Series NPO Ceramic Ultra-Low ESR Multilayer Capacitors

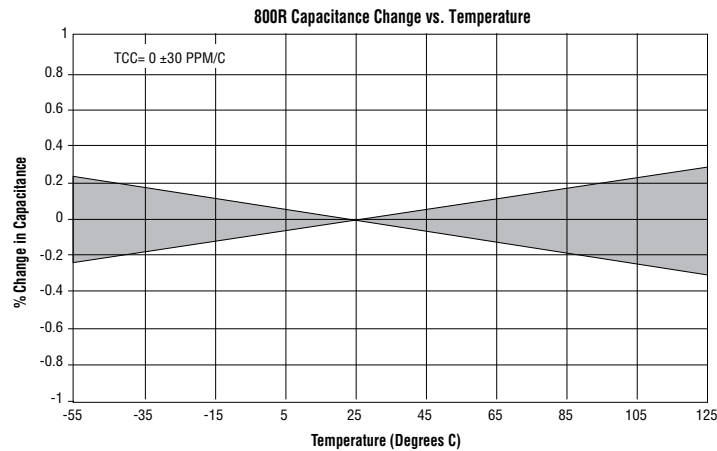
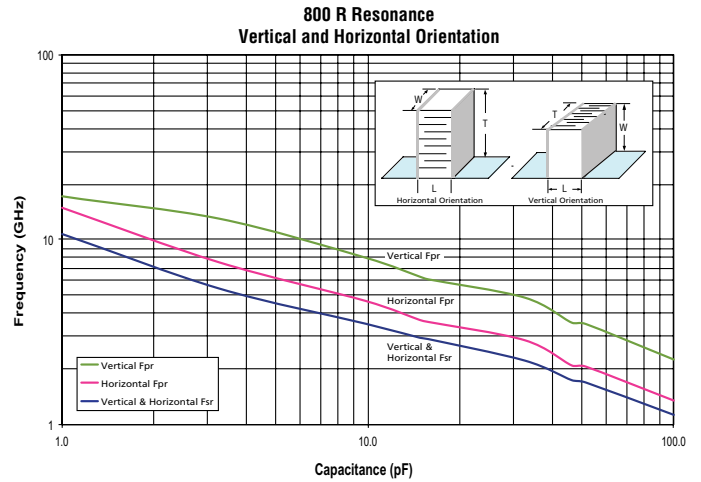
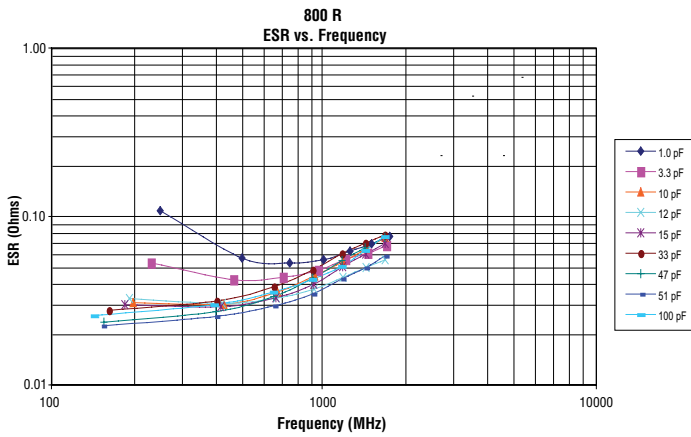

RF/Microwave Capacitors

RF/Microwave Multilayer Capacitors (MLC)

900C Series X7R Ceramic RF Power Multilayer Capacitors

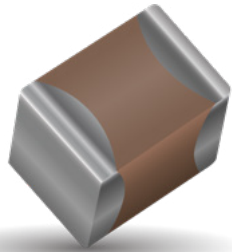

GENERAL DESCRIPTION

KYOCERA AVX, the industry leader, offers new improved ESR/ESL performance for the 900 C Series RF Capacitors. This Series exhibits superior volumetric efficiency, providing high levels of capacitance for HF/ RF power applications. Ceramic construction provides a rugged, hermetic package.

KYOCERA AVX offers an encapsulation option for applications requiring extended protection against arc-over and corona.

FEATURES

- Case C Size (.250" x .250")
- Low ESR / ESL
- Rugged Construction
- Encapsulation Option Available *
- Capacitance Range 0.01 μ F to 1 μ F
- Mid-K
- High Reliability

FUNCTIONAL APPLICATIONS

- Bypass
- DC Blocking
- Coupling

TYPICAL CIRCUIT APPLICATIONS

- HF/RF Power Amplifiers
- High Frequency Switch Mode Power Supplies
- Medical Electronics.

*For leaded styles only.

ENVIRONMENTAL CHARACTERISTICS

Thermal Shock	MIL-STD-202, Method 107, Condition A.
Moisture Resistance	MIL-STD-202, Method 106.
Low Voltage Humidity	MIL-STD-202, Method 103, Condition A, with 1.5 Volts DC applied while subjected to an environment of 85°C with 85% relative humidity for 240 hours min.
Life Test	MIL-STD-202, Method 108, for 2000 hours, at 125°C. 200% WVDC applied.
Solderability	MIL-STD-202, Method 208
Terminal Strength	Terminations for chips and pellets withstand a pull of 5 lbs. min., 10 lbs. typical, for 5 seconds in direction perpendicular to the termination surface of the capacitor.

PACKAGING OPTIONS



Tape & Reel



Vertical Orientation Tape & Reel

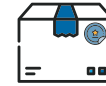

Special Packaging Available



Cap-Pak® (100 pcs)



ELECTRICAL SPECIFICATIONS

Dissipation Factor (DF)	2.5% max. at 1 KHz
Temperature Coefficient of Capacitance (Tcc)	Less than $\pm 15\%$ (-55°C to +125°C)
Insulation Resistance (IR)	0.01 MFd to 1 MFd 1000 megohms min. @ +25°C at rated WVDC. 100 megohms min. @ +125°C at rated WVDC.
Working Voltage (WVDC)	See Capacitance Values Table
Dielectric Withstanding Voltage (DWV)	Case C: 250% of rated WVDC for 5 secs.
Aging Effects	3% maximum per decade hour
Piezoelectric Effects	Negligible
Dielectric Absorption	2% typical
Operating Temperature Range	-55°C to +125°C (No derating of working voltage)
Termination Styles	Available in various surface mount and leaded styles. See Mechanical Configurations
Terminal Strength	Terminations for chips and pellets withstand a pull of 10 lbs. min., 15 lbs. typical, for 5 seconds in direction perpendicular to the termination surface of the capacitor. Test per MIL-STD-202, method 211.

RF/Microwave Capacitors

RF/Microwave Multilayer Capacitors (MLC)

900C Series X7R Ceramic RF Power Multilayer Capacitors



CAPACITANCE VALUES

Cap. Code	Cap. (Mfd)	Tol.	Rated Wvdc
103	.010	K, M, N	300
153	.015		300
223	.022		300
333	.033		250
473	.047		250
683	.068		250
104	.10		200
154	.15		200
224	.22		200
334	.33		150
474	.47		150
684	.68		150
824	.82		100
105	1.0		100

Code	K	M	N
Tol.	±10%	±20%	±30%

VRMS = 0.707 X WVDC

- SPECIAL VALUES, TOLERANCES, HIGHER WVDC AND MATCHING AVAILABLE.
- ENCAPSULATION OPTION AVAILABLE. PLEASE CONSULT FACTORY.

HOW TO ORDER

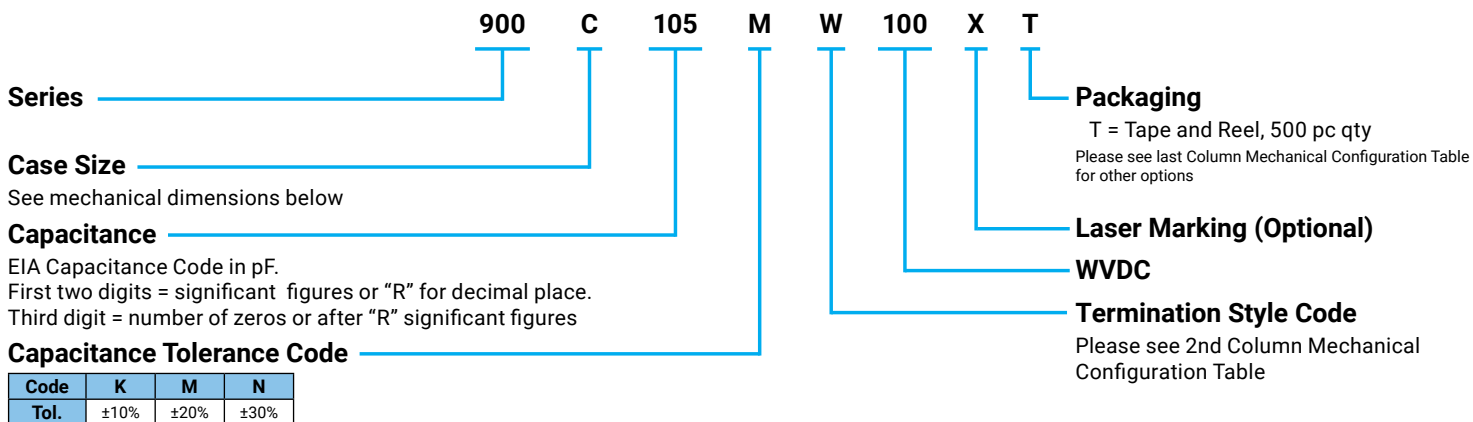

The above part number refers to a 900 C Series (case size C) 1.0 MFd capacitor, M tolerance (±20%), 100 WVDC, with W termination (Tin/Lead, Solder Plated over Nickel Barrier), laser marking and ATC Matrix Tray packaging.

RF/Microwave Capacitors

RF/Microwave Multilayer Capacitors (MLC)

900C Series X7R Ceramic RF Power Multilayer Capacitors



MECHANICAL CONFIGURATIONS

Series & Case Size	Term. Code	Case Size & Type	Outlines W/T Is A Termination Surface	Body Dimensions Inches (Mm)			Lead And Termination Dimensions And Materials		Pkg Type & Qty	Pkg Code
				Length (L)	Width (W)	Thickness (T)	Overlap (Y)	Materials		
900C	W	Solder Plate		.230+.020 -.010 (5.84 +0.51 -0.25)	.250 ±.015 (6.35 ±0.38)	.145 (3.68) max. for capacitance values < 0.82 MFd;	.040 (1.02) max.	Tin/Lead, Solder Plated over Nickel Barrier Termination	T250 T & R 500 Cap PaK 36	T250 T C36
900C	P	Pellet		.230+.025 -.010 (5.84 +0.64 -0.25)				Heavy Tin/Lead Coated, over Nickel Barrier Termination	T250 T&R 500 Cap PaK 36	T250 T C36
900C	T	Solderable Nickel Barrier		.230 +.020 -.010 (5.84 +0.51 -0.25)				RoHS Compliant Tin Plated over Nickel Barrier Termination	T250 T & R 250 Cap PaK 36	T250 T C36
900C	MS	Microstrip		.245 ±.025 (6.22 ±0.64)	.165 (4.19) max. for capacitance values ≥ 0.82 MFd.	N/A		High Purity Silver Leads LL = .500 (12.7) min. WL = .240 ±.005 (6.10 ±.127) TL = .004 ±.001 (.102 ±.025) Leads are Attached with High Temperature Solder.	Cap Pak 24	C24
900C	AR	Axial Ribbon						Box, 24	B24	
900C	AW	Axial Wire						Silver-plated Copper Leads LL = 1.0 (25.4) min. Dia. = .032 ±.002 (0.81 ±0.05)	Cap Pak 24	C24
900C	VA	Vertical Axial Ribbon						Silver Leads LL = .500 (12.7) min. WL = * See below TL = .004 ±.001 (.102 ±.025)	Cap Pak 24	C24
900C	RW	Radial Wire						Silver-plated Copper Leads LL = 1.0 (25.4) min. Dia. = .032 ±.002 (0.81 ±0.05)	Cap Pak 24	C24

Custom lead styles and lengths are available; consult factory. All leads are high purity silver attached with high temperature solder and are RoHS compliant.

** WL = .110 (2.79) for capacitance values < 0.82 MFd.; WL = .130 (3.30) for capacitance values ≥ 0.82 MFd.

RF/Microwave Capacitors

RF/Microwave Multilayer Capacitors (MLC)

900C Series X7R Ceramic RF Power Multilayer Capacitors



NON-MAGNETIC MECHANICAL CONFIGURATIONS

Series & Case Size	Term. Code	Case Size & Type	Outlines W/T Is A Termination Surface	Body Dimensions Inches (Mm)			Lead And Termination Dimensions And Materials		Pkg Type & Qty	Pkg Code
				Length (L)	Width (W)	Thickness (T)	Overlap (Y)	Materials		
900C	WN	C Non-Mag Solder Plate		.230 +.025 -.010 (5.84 + 0.64-0.25)	.250 ±.015 (6.35 ±0.38)	.145 (3.68) max. < 0.82 MFd .165 (4.19) max. ≥0.82 MFd	.040 (1.02) max.	Tin/Lead, Solder Plated over Non-Magnetic Barrier Termination	T & R 500 Cap PaK 36	T C36
900C	TN	C Non-Mag Solderable Barrier		.230 +.025 -.010 (5.84 + 0.64-0.25)				RoHS Compliant Tin Plated over Non-Magnetic Barrier Termination	T & R 500 Cap PaK 36	T C36

Custom lead styles and lengths are available; consult factory. All leads are high purity silver attached with high temperature solder and are RoHS compliant. 105M 105M

SUGGESTED MOUNTING PAD DIMENSIONS

Horizontal Electrode Orientation

Vertical Electrode Orientation

Case C Vertical Mount					
Cap Value	Pad Size	A Min.	B Min.	C Min.	D Min.
< .82 μF	Normal	.150	.050	.200	.300
	High Density	.130	.030	.200	.260
≥ .82 μF	Normal	.185	.050	.200	.300
	High Density	.165	.030	.200	.260

Horizontal Mount					
All Values	Pad Size	A Min.	B Min.	C Min.	D Min.
All Values	Normal	.150	.050	.200	.300
	High Density	.130	.030	.200	.260

RF/Microwave Capacitors

RF/Microwave Multilayer Capacitors (MLC)

900C Series X7R Ceramic RF Power Multilayer Capacitors



PERFORMANCE DATA

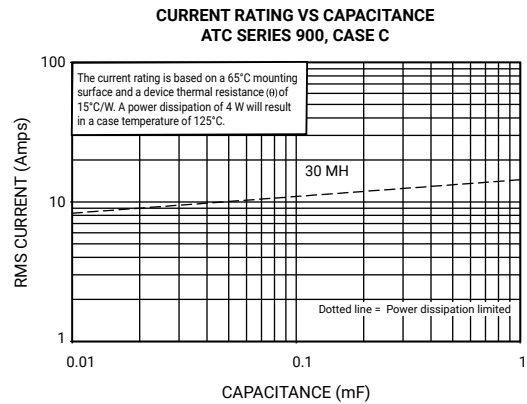
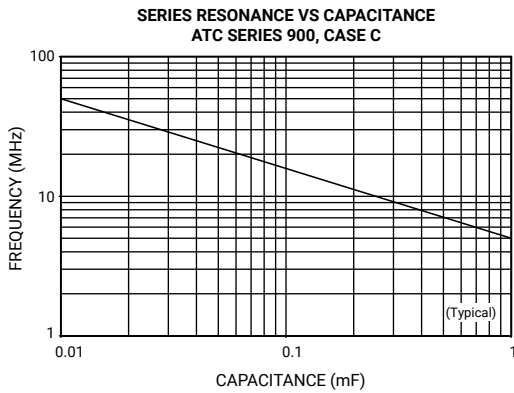
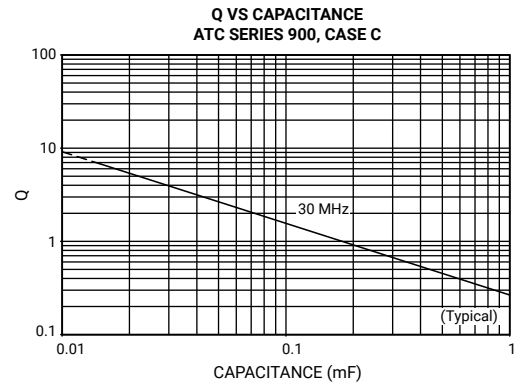
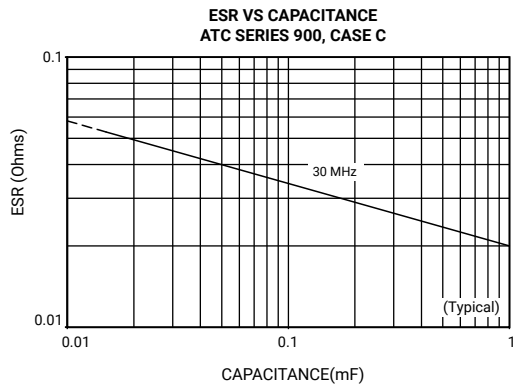

RF/Microwave Capacitors

RF/Microwave Multilayer Capacitors (MLC)

920C Series X7R Ceramic RF Power Multilayer Capacitors

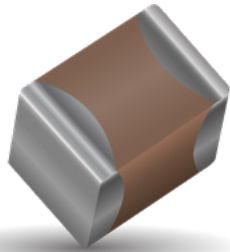

GENERAL DESCRIPTION

KYOCERA AVX's 920C Series MLC capacitors offer superior quality at a competitive price. This MLC Series is manufactured for KYOCERA AVX in accordance with KYOCERA AVX's high quality standards. Ceramic construction provides a rugged and reliable hermetic package. Available termination styles include a standard solder plate over a nickel barrier for most applications and palladium silver for non-magnetic applications commonly used in medical electronics.

FEATURES

- Case C Size (.250" x .250")
- Low ESR / ESL
- Rugged Construction
- Encapsulation with Encapsulation Option*
- Capacitance Range 0.01 μ F to 1 μ F
- Mid-K
- High Reliability

FUNCTIONAL APPLICATIONS

- Bypass
- DC Blocking
- Coupling

CIRCUIT APPLICATIONS

- HF Amplifiers
- Switch Mode Power Supplies
- High Frequency SMPS Filters

*For leaded styles only.

ENVIRONMENTAL CHARACTERISTICS

Thermal Shock	MIL-STD-202, Method 107, Condition A.
Moisture Resistance	MIL-STD-202, Method 106.
Low Voltage Humidity	MIL-STD-202, Method 103, Condition A, with 1.5 Volts DC applied while subjected to an environment of 85°C with 85% relative humidity for 240 hours min.
Life Test	MIL-STD-202, Method 108, for 2000 hours, at 125°C. 200% WVDC applied.
Solderability	MIL-STD-202, Method 208

PACKAGING OPTIONS



Tape & Reel



Vertical Orientation Tape & Reel

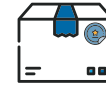

Special Packaging Available



Cap-Pak® (100 pcs)



ELECTRICAL SPECIFICATIONS

Dissipation Factor (DF)	2.5% max. at 1 KHz
Temperature Coefficient of Capacitance (Tcc)	Less than $\pm 15\%$ (-55°C to +125°C)
Insulation Resistance (IR)	0.01 MFd to 1 MFd 1000 megohms min. @ +25°C at rated WVDC. 100 megohms min. @ +125°C at rated WVDC.
Working Voltage (WVDC)	See Capacitance Values Table
Dielectric Withstanding Voltage (DWV)	Case C: 250% of rated WVDC for 5 secs.
Aging Effects	3% maximum per decade hour
Piezoelectric Effects	Negligible
Dielectric Absorption	2% typical
Operating Temperature Range	-55°C to +125°C (No derating of working voltage)
Termination Styles	Available in various surface mount and leaded styles. See Mechanical Configurations
Terminal Strength	Terminations for chips and pellets withstand a pull of 10 lbs. min., 15lbs. typical, for 5 seconds in direction perpendicular to the termination surface of the capacitor. Test per MIL-STD-202, method 211.

RF/Microwave Capacitors

RF/Microwave Multilayer Capacitors (MLC)

920C Series X7R Ceramic RF Power Multilayer Capacitors



CAPACITANCE VALUES

Cap. Code	Cap. (Mfd)	Tol.	Rated Wvdc	Cap. Code	Cap. (Mfd)	Tol.	Rated Wvdc
103	.010	K, M	300	224	.22	K, M	200
153	.015			334	.33		150
223	.022			474	.47		
333	.033		250	684	.68		100
473	.047			824	82		
683	.068			105	1.0		
104	.10		200	-	-		-
154	.15			-	-		

HOW TO ORDER

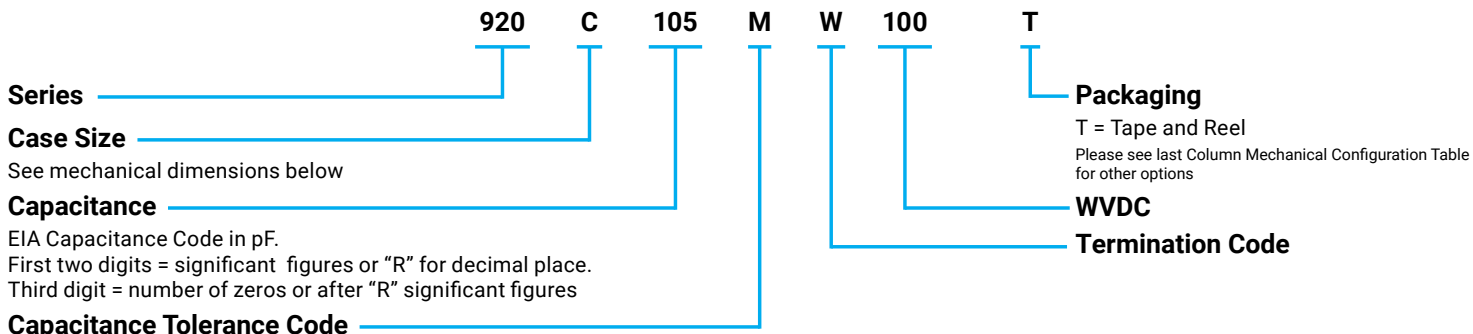

Code	K	M
Tol.	±10%	±20%

The above part number refers to a 920 C Series (case size C) 1.0 MFd capacitor, M tolerance (±20%), 100 WVDC, with W termination (solder plate) and Tape and Reel Packaging.

MECHANICAL CONFIGURATIONS

Series & Case Size	Term. Code	Case Size & Type	Outlines W/T Is A Termination Surface	Body Dimensions Inches (mm)			Lead And Termination Dimensions and Materials		Pkg Type & Qty	Pkg Code
				Length (L)	Width (W)	Thickness (T)	Overlap (Y)	Materials		
920C	W	C Solder Plate		0.22+0.020 -0.010 (5.58+0.51 -0.25)	.250 ±0.015 (6.35 ±0.38)	.157 (3.98) max.	.040 (1.02) max.	SOLDER PLATE Nickel barrier, solder plated. Rugged high performance termination for lower cost, high volume applications	T & R 500 Cap PaK 36	T C36
920C	T	C Solderable Nickel Barrier		0.22+0.020 -0.010 (5.58+0.51 -0.25)	.250 ±0.01 (6.35 ±0.25)	.157 (3.98) max.		RoHS Compliant Tin Plated over Nickel Barrier Termination	T & R 500 Cap PaK 36	T C36

NON-MAGNETIC MECHANICAL CONFIGURATIONS

Series & Case Size	Term. Code	Case Size & Type	Outlines W/T Is A Termination Surface	Body Dimensions Inches (mm)			Lead And Termination Dimensions and Materials		Pkg Type & Qty	Pkg Code
				Length (L)	Width (W)	Thickness (T)	Overlap (Y)	Materials		
920C	CN	C Non-Mag Chip		0.22+0.020 -0.010 (5.58+0.51 -0.25)	.250 ±0.01 (6.35 ±0.25)	.157 (3.98) max.	.045 (1.14) max.	NON-MAGNETIC PALLADIUM SILVER TERMINATIONS	T & R 500 Cap PaK 36	T C36
920C	TN	C Non-Mag Solderable Nickel Barrier		0.22+0.020 -0.010 (5.58+0.51 -0.25)	.250 ±0.01 (6.35 ±0.25)	.157 (3.98) max.	.045 (1.14) max.	RoHS Compliant Tin Plated over Non-Magnetic L T Barrier Termination	T & R 500 Cap PaK 36	T C36

RF/Microwave Multilayer Capacitors (MLC)

CDR Series – MIL-PRF-55681/4/5 (RF/Microwave Chips)

HOW TO ORDER

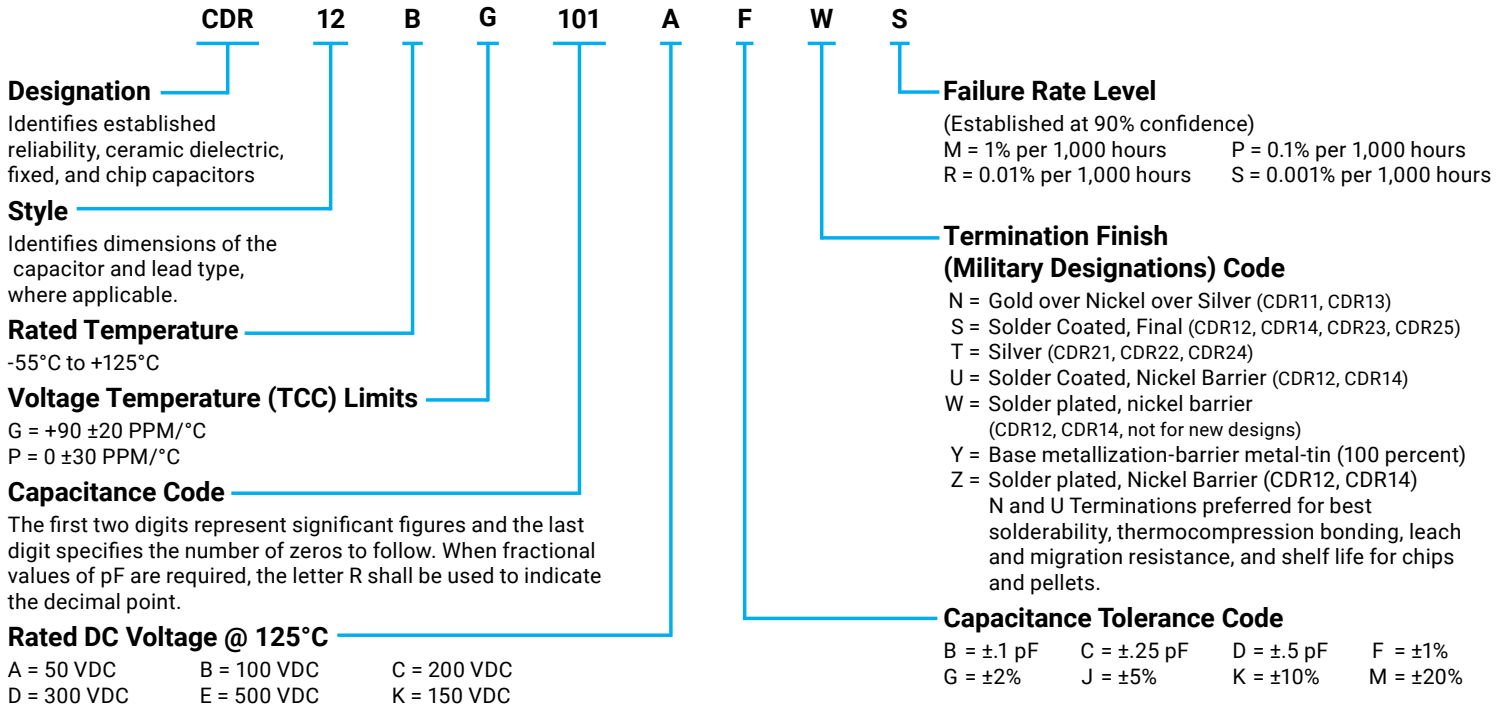

TABLE I - STYLES CDR11 AND CDR12 CAPACITOR CHARACTERISTICS

Type Designation *	Capacitance Range (pF)	Capacitance Tolerance Available	Rated Temp. & Voltage-Temp Limits	Rated DC Voltage
CDR1-B-0R1KB-- to CDR1-B-0R2--B--	0.1 pF to 0.2 pF	B	Characteristic BG (+90 ±20 PPM/°C) and Characteristic BP (0 ±30 PPM/°C)	A = 50 K = 150
CDR1-B-0R3K--- to CDR1-B-0R4---	0.3 pF to 0.4 pF	B, C		
CDR1-B-0R5K--- to CDR1-B-2R2---**	0.5 pF to 2.2 pF	B, C, D		
CDR1-B-2R4K--- to CDR1-B-6R2---***	2.4 pF to 6.2 pF	B, C, D		
CDR1-B-6R8K--- to CDR1-B-9R1---***	6.8 pF to 9.1 pF	B, C, J, K, M		
CDR1-B-100K--- to CDR1-B-101K---***	10 pF to 100 pF	F, G, J, K, M		
CDR1-BP111K-- to CDR1-BP621---***	110 pF to 620 pF	F, G, J, K, M	BP	A = 50 B = 100
CDR1-BP681A-- to CDR1-BP102---***	680 pF to 1000 pF	F, G, J, K, M		

TABLE II - STYLES CDR13 AND CDR14 CAPACITOR CHARACTERISTICS

Type Designation *	Capacitance Range (pF)	Capacitance Tolerance Available	Rated Temp. & Voltage-Temp Limits	Rated DC Voltage
CDR1-B-0R1EB-- to CDR1-B-0R2---B--	0.1 pF to 0.2 pF	B	"Characteristic BG (+90 ±20 PPM/°C) and Characteristic BP (0 ±30 PPM/°C)"	
CDR1-B-0R3E--- to CDR1-B-0R4---	0.3 pF to 0.4 pF	B, C		
CDR1-B--0R5E--- to CDR1-B-2R2---**	0.5 pF to 2.2 pF	B, C, D		C = 200
CDR1-B-2R4E--- to CDR1-B-6R2---***	2.4 pF to 6.2 pF	B, C, D		E = 500
CDR1-B-6R8E--- to CDR1-B-9R1---***	6.8 pF to 9.1 pF	B, C, J, K, M		
CDR1-B-100E--- to CDR1-B-101---***	10 pF to 100 pF	F, G, J, K, M		
CDR1-B-111D--- to CDR1-B-201---***	110 pF to 200 pF			C = 200 D = 300
CDR1-B-221C--- to CDR1-B-471C---***	220 pF to 470 pF			C = 200
CDR1-B-511B--- to CDR1-B-621---***	510 pF to 620 pF			A = 50 B = 100
CDR1-B-681A--- to CDR1-B-102A---***	680 pF to 1000 pF			A = 50
CDR1-BP112A-- to CDR1-BP512A---***	1100 pF to 5100 pF			BP

* Complete type designation will include additional symbols to indicate style, voltage-temperature limits, capacitance tolerance (where applicable), termination finish, and failure rate level.
 ** Intermediate values in this category are in 0.1 pF steps.
 *** Intermediate values in each category are given by the RETMA 5% Table.

RF/Microwave Multilayer Capacitors (MLC)

CDR Series – MIL-PRF-55681/4/5 (RF/Microwave Chips)

TABLE III - STYLES CDR21-CDR25 CAPACITOR CHARACTERISTICS

Type Designation *	Capacitance Range (pF)	Capacitance Tolerance Available	Rated Temp. & Voltage-Temp Limits	Rated DC Voltage
CDR2-B-0R1EB-- to CDR2-B-0R2EB--	0.1 pF to 0.2 pF	B	Characteristic BG (+90 ±20 PPM/°C) and Characteristic BP (0 ±30 PPM/°C)	500 = E
CDR2-B-0R3E--- to CDR2-B-0R4E---	0.3 pF to 0.4 pF	B, C		
CDR2-B-0R5E--- to CDR2-B-2R2E---**	0.5 pF to 2.2 pF	B, C, D		
CDR2-B-2R4E--- to CDR2-B-6R2E---***	2.4 pF to 6.2 pF	B, C, D		
CDR2-B-6R8E--- to CDR2-B-9R1E---***	6.8 pF to 9.1 pF	B, C, J, K, M		
CDR21-B-100E--- to CDR2-B-101E---***	10 pF to 100 pF	F, G, J, K, M		300 = D
CDR2-B-111D--- to CDR2-B-201D---***	110 pF to 200 pF			200 = C
CDR2-B-221C--- to CDR2-B-471C---***	220 pF to 470 pF			100 = B
CDR2-B-511B--- to CDR2-B-621B---***	510 pF to 620 pF			50 = A
CDR2-B-681A--- to CDR2-B-102A---***	680 pF to 1000 pF			
CDR2-BP112A-- to CDR2-BP512A---***	1100 pF to 5100 pF		BP	

* Complete type designation will include additional symbols to indicate style, voltage-temperature limits, capacitance tolerance (where applicable), termination finish (T for styles CDR21, CDR22 and CDR24, and S for styles CDR23 and CDR25), and failure rate level. Please note: Leaded devices CDR 21 through CDR 25 are available to the R Failure Rate Level only.

** Intermediate values in this category are in 0.1 pF steps.

*** Intermediate values in each category are given by the RETMA 5% Table as follows: 10, 11, 12, 13, 15, 16, 18, 20, 22, 24, 27, 30, 33, 36, 39, 43, 47, 51, 56, 62, 68, 75, 82, 91.

TABLE I - STYLES CDR11 AND CDR12 CAPACITOR CHARACTERISTICS

MIL-PRF-55681 Styles	Case Size	Type	Outlines	Body Dimensions			Lead & Termination Dimensions & Materials			
				Length	Width	Thickness				
CDR 11	A	Chip CA		.055 ±.015 (1.4 ±0.38)			.020/.057 (0.51/1.45)			
CDR 13	B	Chip CA	 W/T is a Termination Surface	.110 ±.020 (2.79 ±0.51)			.030/.102 (0.76/2.59)			
CDE 12	A	Pellet P		.055 ±.025 (1.4 ±0.63)	.055 ±.015 (1.4 ±0.38)	.020/.057 (0.51/1.45)				
CDR 14	B	Pellet P	 W/T is a Termination Surface	.110 +.035 -.020 (2.79 +0.89 -0.51)		.110 ±.020 (2.79 ±0.51)	.030/.102 (0.76/2.59)			
CDR 12	A	Solder Plate W		.055 ±.015 (1.4 ±0.38)			.020/.057 (0.51/1.45)			
CDR 14	B	Solder Plate W	 W/T is a Termination Surface	.110 ±.020 (2.79 ±0.51)			.030/.102 (0.76/2.59)			
CDR 21	B	Microstrip MS		.135 ±.015 (3.43 ±0.38)	.110 ±.015 (2.79 ±0.38)	.060/.100 (1.52/2.54)	Termination T = Silver			
CDR 22	B	Axial Ribbon AR					Length	Width	Thickness	
CDR 24	B	Radial Ribbon RR					min.	.093±.005 (2.36±0.13)	.004±.001 (0.10±0.03)	
CDR 23	B	Radial Wire RW					.250 (6.35)			
CDR 25	B	Axial Wire AW					Terminations S = Solder Coated			
							min.	#26 AWG		
							.50 (12.7)	.016 (.375) dia. nom.		

All dimensions are in inches, except those in parentheses which are in millimeters.

All leads and ribbon are silver and are attached with high temperature solder.

RF/Microwave Multilayer Capacitors (MLC)

CDR Series – MIL-PRF-55681/4/5 (RF/Microwave Chips)

Style	Equiv. KYOCERA AVX Part No. Characteristics	
	BG	BP
CDR11	100A	700A
CDR12	100A	700A
CDR13	100B	700B
CDR14	100B	700B

Style	Equiv. KYOCERA AVX Part No. Characteristics	
	BG	BP
CDR21	100B ----- MS	700B ----- MS
CDR22	100B ----- AR	700B ----- AR
CDR23	100B ----- RW	700B ----- RW
CDR24	100B ----- RR	700B ----- RR
CDR25	100B ----- AW	700B ----- AW

PACKAGING

Standard Packaging Quantity
 CDR11-12 = 100 pcs per waffle pack
 CDR13-14 = 100 pcs per waffle pack

TAPE & REEL

All tape and reel specifications are in compliance with EIA RS481 (equivalent to IEC 286 part 3).
 Sizes CDR11/12 through 13/14.
 – 8mm carrier
 – 7" reel: $\leq 0.040"$ thickness = 100, 300, 500, 1000, 2000* pcs
 $\leq 0.075"$ thickness = 100, 300, 500, 1000, 2000* pcs
 * QTY 2000 only applies to CDR11-12

RF/Microwave Multilayer Capacitors (MLC) Performance Curves



TYPICAL Q vs. FREQUENCY
MIL-PRF-55681E - BG

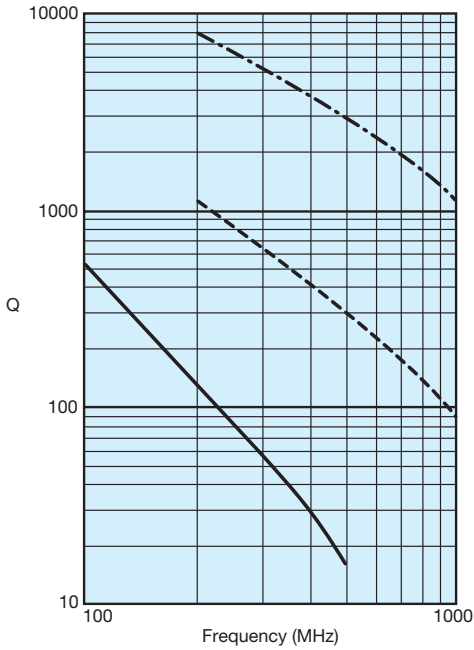

--- 1 Picofarad - - - 10 Picofarad — 100 Picofarad

TYPICAL ESR vs. FREQUENCY
MIL-PRF-55681E - BG

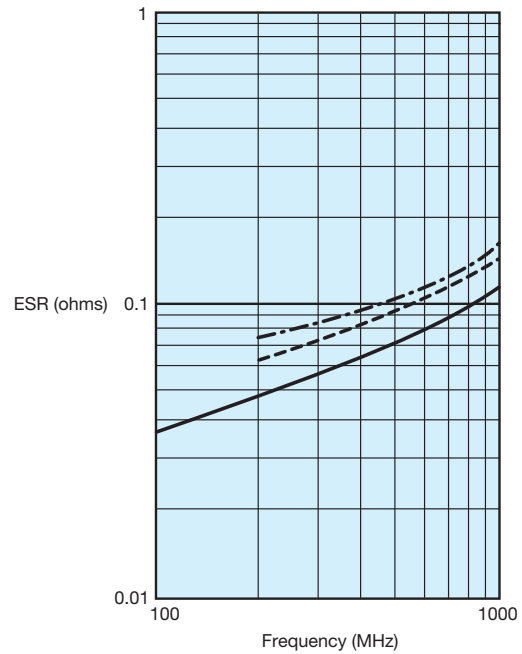

--- 3.3 Picofarad - - - 10 Picofarad — 100 Picofarad

TYPICAL Q vs. CAPACITANCE
MIL-PRF-55681E - BG

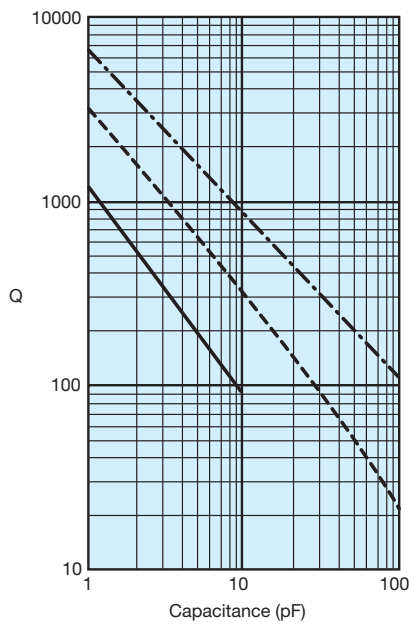

--- 250 MHz - - - 500 MHz — 1000 MHz

TYPICAL ESR vs. CAPACITANCE
MIL-PRF-55681E - BG

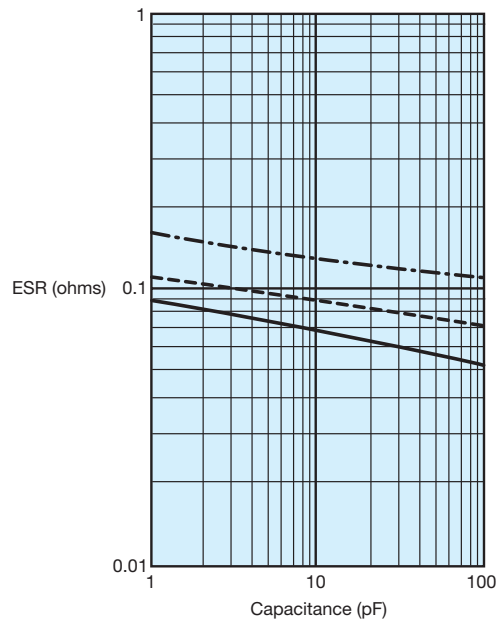

--- 250 MHz - - - 500 MHz — 1000 MHz

RF/Microwave Multilayer Capacitors (MLC) Performance Curves

**TYPICAL Q vs. FREQUENCY
MIL-PRF-55681E - BG**

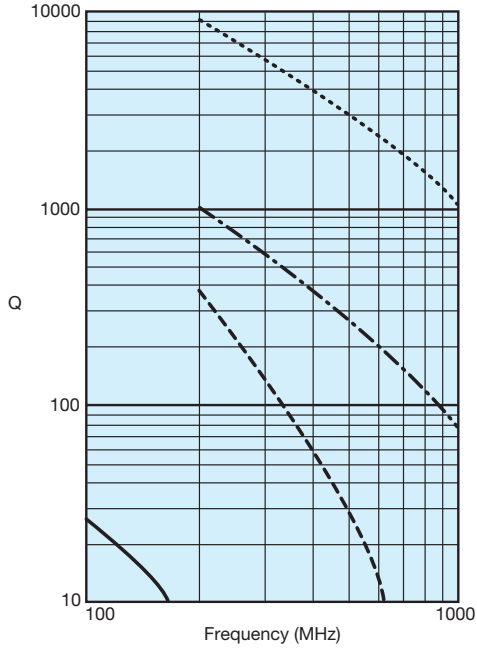

----- 1 Picofarad - - - - 10 Picofarad - - - - 47 Picofarad ——— 330 Picofarad

**TYPICAL ESR vs. FREQUENCY
MIL-PRF-55681E - BG**

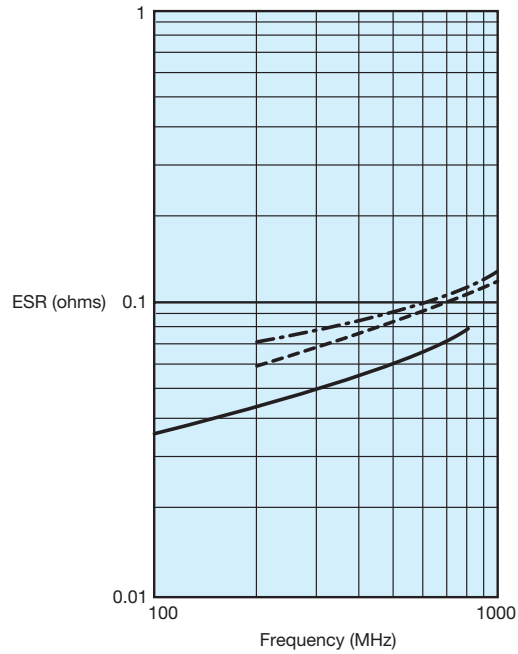

----- 1 Picofarad - - - - 15 Picofarad ——— 100 Picofarad

**TYPICAL Q vs. CAPACITANCE
MIL-PRF-55681E - BG**

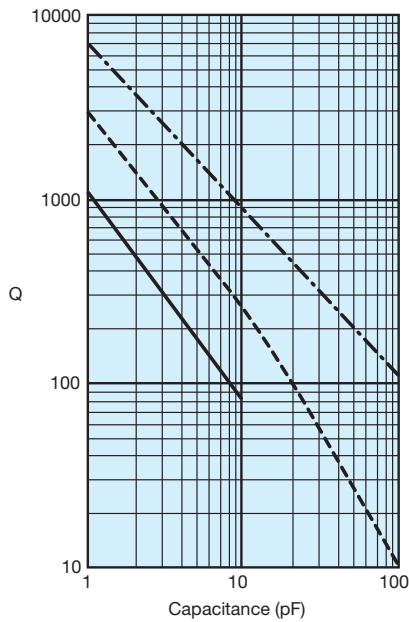

----- 250 MHz - - - - 500 MHz ——— 1000 MHz

**TYPICAL ESR vs. CAPACITANCE
MIL-PRF-55681E - BG**

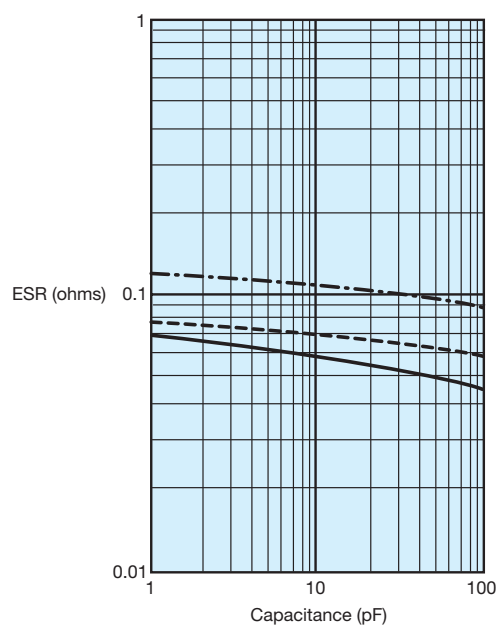

----- 250 MHz - - - - 500 MHz - - - - 1000 MHz

RF/Microwave Multilayer Capacitors (MLC) Performance Curves

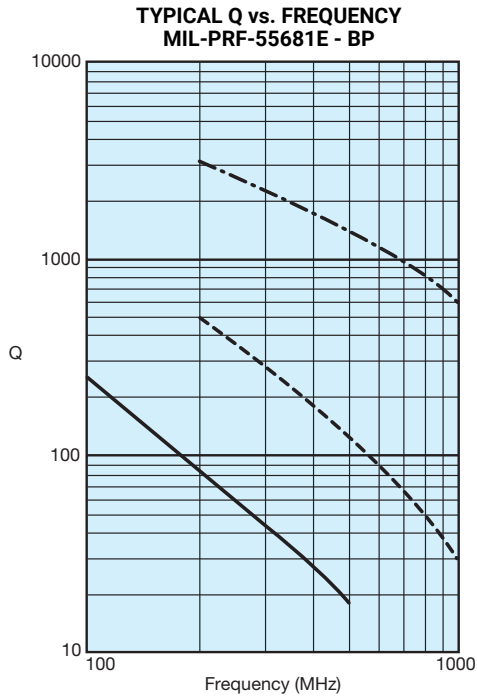

--- 1 Picofarad - - - 15 Picofarad — 100 Picofarad

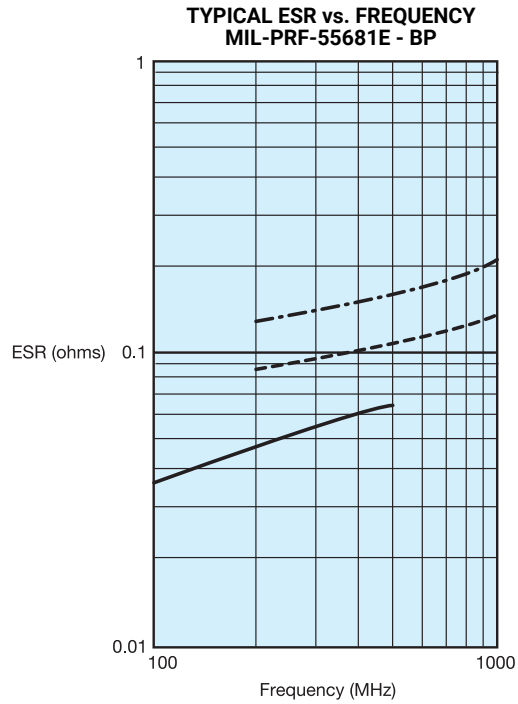

--- 15 Picofarad - - - 47 Picofarad — 100 Picofarad

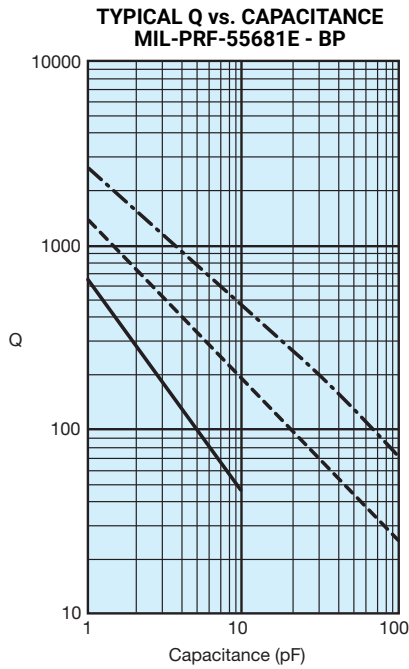

--- 250 MHz - - - 500 MHz — 1000 MHz

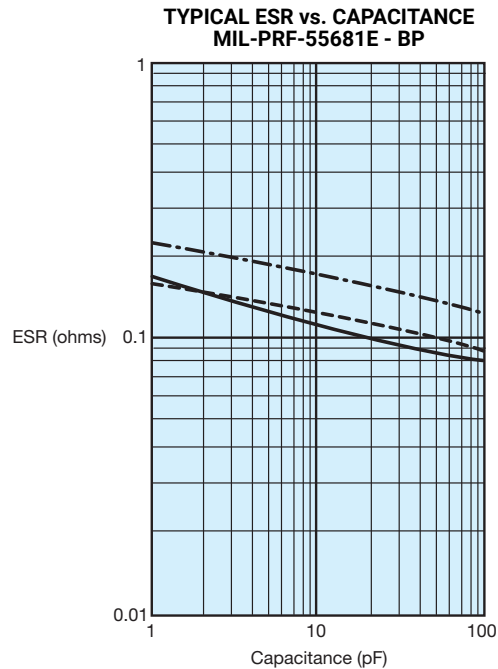

--- 250 MHz - - - 500 MHz — 1000 MHz

RF/Microwave Multilayer Capacitors (MLC) Performance Curves

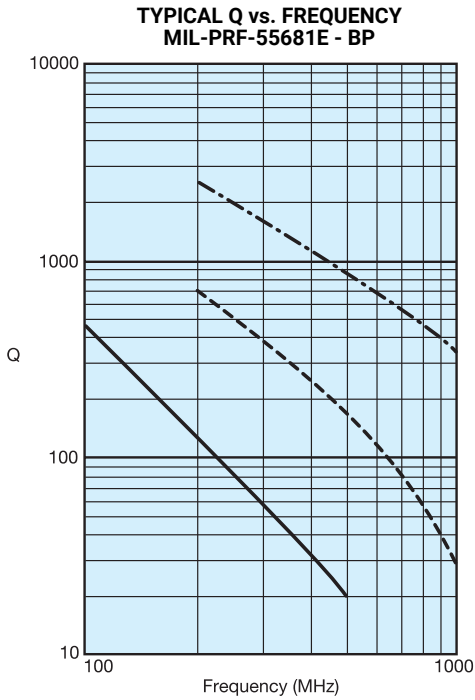

--- 2 Picofarad - - - 15 Picofarad — 100 Picofarad

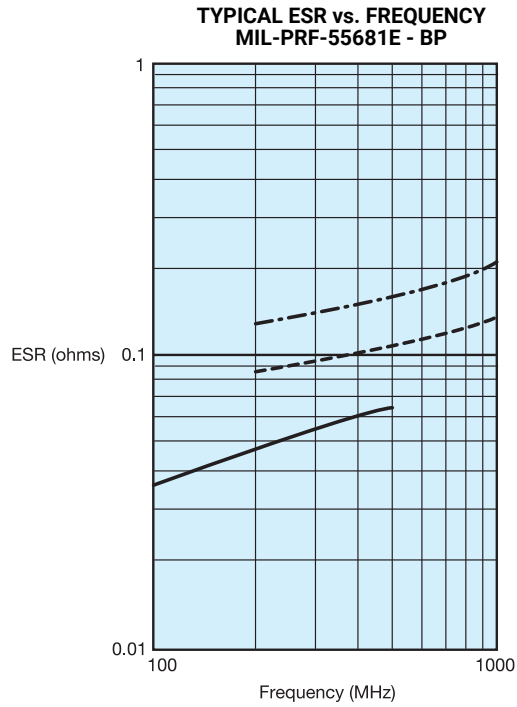

--- 15 Picofarad - - - 47 Picofarad — 100 Picofarad

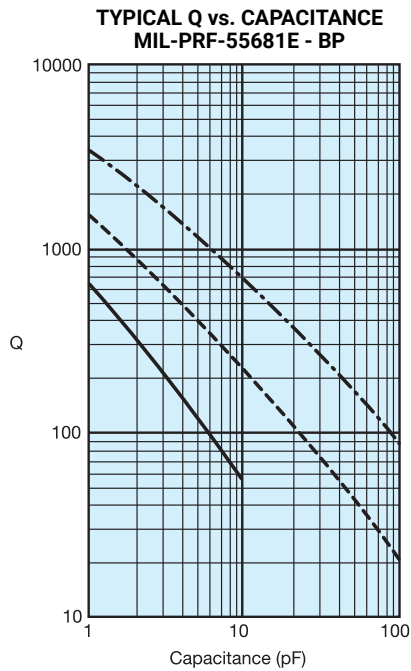

--- 250 MHz - - - 500 MHz — 1000 MHz

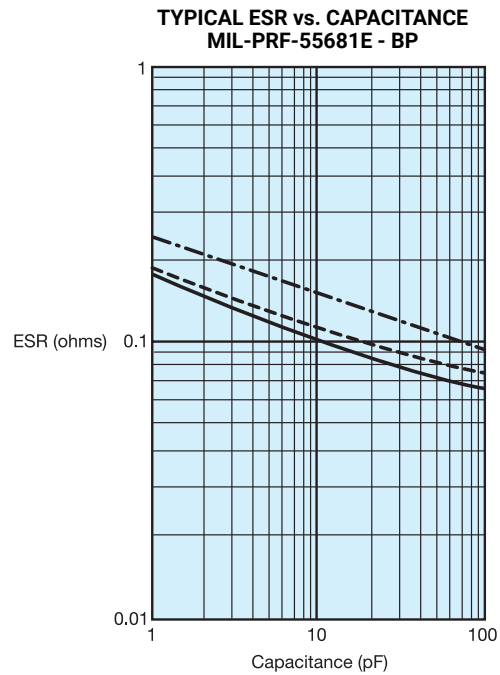

--- 250 MHz - - - 500 MHz — 1000 MHz

RF/Microwave Multilayer Capacitors (MLC) Performance Curves

TYPICAL RESONANT FREQUENCY vs. CAPACITANCE
(CDR11-14)

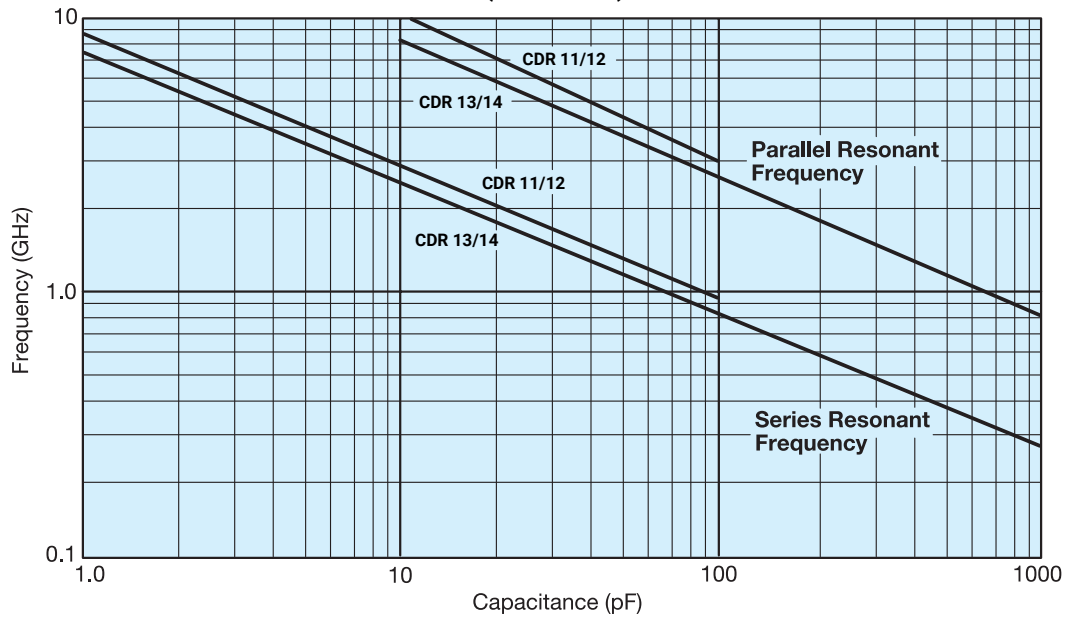

RF/Microwave Capacitors

RF/Microwave Multilayer Capacitors (MLC)

Automatic Insertion Packaging



TAPE & REEL:

All tape and reel specifications are in compliance with EIA RS481 (equivalent to IEC 286 part 3).

Sizes SQCA through SQCB, CDR11/12 through 13/14.

—8mm carrier

—7" reel: ≤ 0.040 " thickness = 2000 pcs
 ≤ 0.075 " thickness = 2000 pcs

—13" reel: ≤ 0.075 " thickness = 10,000 pcs
 "U" Series - 402/0603/0805/1210 Size Chips

—8mm carrier

—7" reel: 0402 = 10,000 pcs
 0603 & 0805 ≤ 0.40 " thickness = 4000 pcs
 0805 .040" thickness & 1210 = 2000 pcs

—13" reel: ≤ 0.075 " thickness = 10,000 pcs

REEL DIMENSIONS: millimeters (inches)

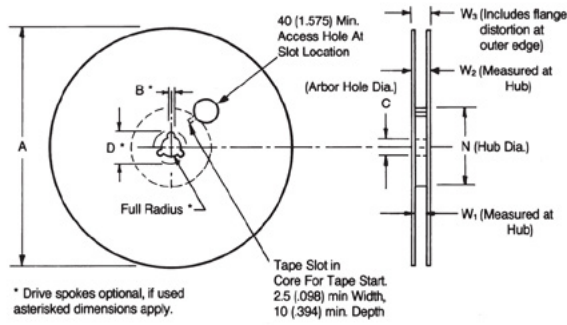

Tape Size ⁽¹⁾	A Max.	B* Min.	C	D* Min.	N Min.	W ₁	W ₂ Max.	W ₃
8mm	330 (12.992)	1.5 (.059)	13.0±0.20 (.512±.008)	20.2 (.795)	50 (1.969)	8.4 ^{+1.0} _{-0.0} (.331 ^{+0.60} _{-0.0})	14.4 (.567)	7.9 Min. (.311) 10.9 Max. (.429)
12mm	330 (12.992)	1.5 (.059)	13.0±0.20 (.512±.008)	20.2 (.795)	50 (1.969)	12.4 ^{+2.0} _{-0.0} (.488 ^{+0.76} _{-0.0})	18.4 (.724)	11.9 Min. (.469) 15.4 Max. (.607)

Metric dimensions will govern.

English measurements rounded and for reference only.

(1) For tape sizes 16mm and 24mm (used with chip size 3640) consult EIA RS-481 latest revision.

EMBOSSED CARRIER CONFIGURATION

8 & 12 MM TAPE ONLY

CONSTANT DIMENSIONS

Tape Size	D ₀	E	P ₀	P ₂	T Max.	T ₁	G ₁	G ₂
8mm and 12mm	8.4 ^{+0.10} _{-0.0} (.059 ^{+0.004} _{-0.0})	1.75 ± 0.10 (.069 ± .004)	4.0 ± 0.10 (.157 ± .004)	2.0 ± 0.05 (.079 ± .002)	0.600 (.024)	0.10 (.004) Max.	0.75 (.030) Min. See Note 3	0.75 (.030) Min. See Note 4

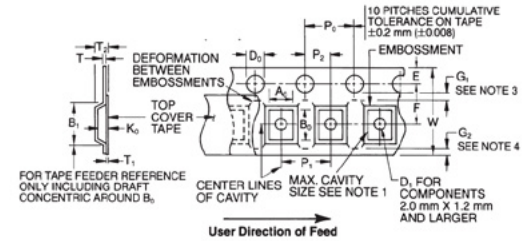

VARIABLE DIMENSIONS

Tape Size	B ₁ Max. See Note 6	D ₁ Min. See Note 5	F	P ₁	R Min. See Note 2	T ₂	W	A ₀ B ₀ K ₀
8mm	4.55 (.179)	1.0 (.039)	3.5 ± 0.05 (.138 ± .002)	4.0 ± 0.10 (.157 ± .004)	25 (.984)	2.5 Max (.098)	8.0 ^{+0.3} _{-0.0} (.315 ^{+0.12} _{-0.004})	See Note 1
12mm	8.2 (.323)	1.5 (.059)	5.5 ± 0.05 (.217 ± .002)	4.0 ± 0.10 (.157 ± .004)	30 (1.181)	6.5 Max (.256)	12.0 ± .30 (.472 ± .012)	See Note 1

NOTES:

- A₀, B₀, and K₀ are determined by the max. dimensions to the ends of the terminals extending from the component body and/or the body dimensions of the component. The clearance between the end of the terminals or body of the component to the sides and depth of the cavity (A₀, B₀, and K₀) must be within 0.05 mm (.002) min. and 0.50 mm (.020) max. The clearance allowed must also prevent rotation of the component within the cavity of not more than 20 degrees (see sketches C & D).
- Tape with components shall pass around radius "R" without damage. The minimum trailer length (Note 2 Fig. 3) may require additional length to provide R min. for 12mm embossed tape for reels with hub diameters approaching N min. (Table 4).
- G₁ dimension is the flat area from the edge of the sprocket hole to either the outward deformation of the carrier tape between the embossed cavities or to the edge of the cavity whichever is less.
- G₂ dimension is the flat area from the edge of the carrier tape opposite the sprocket holes to either the outward deformation of the carrier tape between the embossed cavity or to the edge of the cavity whichever is less.
- The embossment hole location shall be measured from the sprocket hole controlling the location of the embossment. Dimensions of embossment location and hole location shall be applied independent of each other.
- B₁ dimension is a reference dimension for tape feeder clearance only.

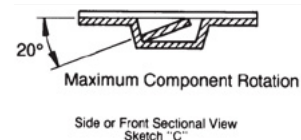
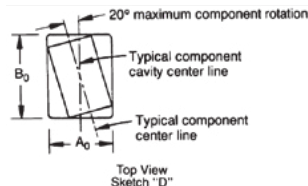

RF/Microwave Capacitors

RF/Microwave COG (NP0) Capacitors

Ultra Low ESR "CU" Series, COG (NP0) Capacitors (RoHS)

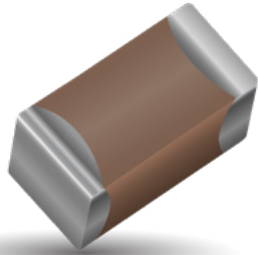

GENERAL INFORMATION

"CU" Series capacitors are COG (NP0) chip capacitors specially designed for "Ultra" low ESR for applications in the communications market. Sizes available are EIA chip sizes 01005 and 0201.



DIMENSIONS:

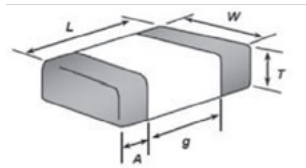

01005

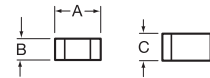

0201

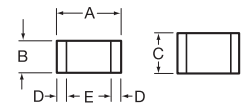

ELECTRICAL CHARACTERISTICS

Capacitance Value Range:

Size 01005 0.2 to 24pF

Size 0201 0.2 to 24pF

Temperature Coefficient of Capacitance (TC):

0±30 ppm/°C (-55° to +125°C)

Insulation Resistance (IR):

10¹² Ω min. @ 25°C and rated WVDC

10¹¹ Ω min. @ 125°C and rated WVDC

Working Voltage (WVDC):

Size Working Voltage

01005 - 16V, 25V (0.2pF-10pF), 16V (10pF-24pF)

0201 - 25 WVDC

Size	mm (inches)				
	L (Length)	W (Width)	T (Max. Thickness)	g (min.)	A (Termination Min./Max.)
0402 (01005)	0.40±0.02 (0.016±0.0008)	0.20±0.02 (0.008±0.0008)	0.22 (0.009)	0.13 (0.005)	0.70/0.14 (0.003/0.006)
0603 (0201)	0.60±0.03 (0.024±0.001)	0.30±0.03 (0.012±0.001)	0.33 (0.013)	0.15 (0.006)	0.10/0.20 (0.004/0.008)

HOW TO ORDER

CU01	3	1	100	J	A	T	2	A
Case Size CU10 = 01005 CU01 = 0201	Voltage Code 3 = 25V Y = 16V	Dielectric 1 = 0±30ppm COG (NP0)	Capacitance EIA Capacitance Code in pF.	Capacitance Tolerance Code A = ±0.05pF B = ±0.1pF C = ±0.25pF D = ±0.5pF G = ±2% J = ±5%	Failure Rate Code A = Not Applicable	Termination T = Plated Ni and Sn	Packaging Code 2 = 7" Reel 4 = 13" Reel U = 7" Reel 4mm TR (01005)	Special A = Standard

First two digits = significant figures or "R" for decimal place.
Third digit = number of zeros or after "R" significant figures.



RF/Microwave Capacitors

RF/Microwave C0G (NP0) Capacitors

Ultra Low ESR "CU" Series, C0G (NP0) Capacitors (RoHS)



CAPACITANCE RANGE

Cap (pF)	Available Tolerance	
	01005	0201
0.5	B,C,D	B,C,D
0.75		
1.0		
1.2		
1.5		
1.8		
2.2		
2.7		
3.3		
3.9		
4.7		B,C,D
5.6		C,D
6.2		C,D
6.8		D
8.2		D
10.0	G,J,K	J,K
12.0		
15.0		
18.0		
22.0		
24.0		

ULTRA LOW ESR, "CU" SERIES0

01005 6.2pF

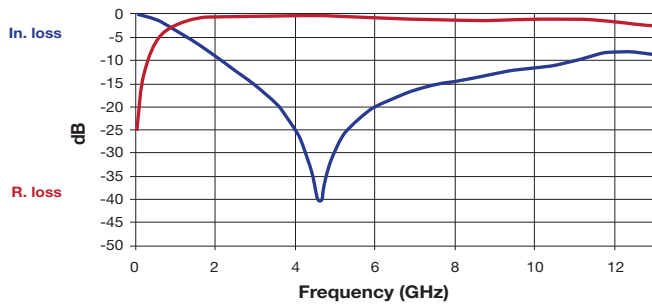

	F (GHz)	IL	R. loss
F1	0.31	-0.40	-9.68
F2	1.28	-5.03	-1.44
F3	2.408	-11.58	-0.27
F4	4.635	-40.55	-0.39
F5	4.897	-31.82	-0.47

0201 4.7pF

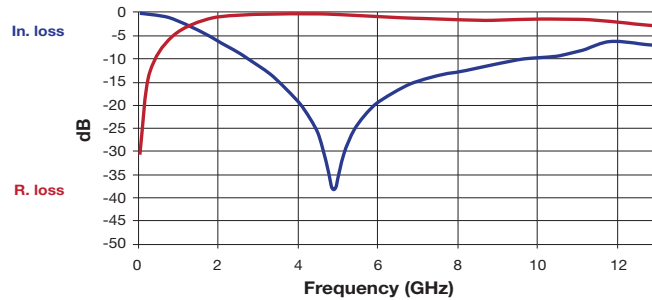

	F (GHz)	IL	R. loss
F1	0.31	-0.13	-12.90
F2	1.28	-2.89	-2.84
F3	2.408	-8.09	-0.60
F4	4.635	-29.45	-0.37
F5	4.897	-38.55	-0.45

0201 22pF

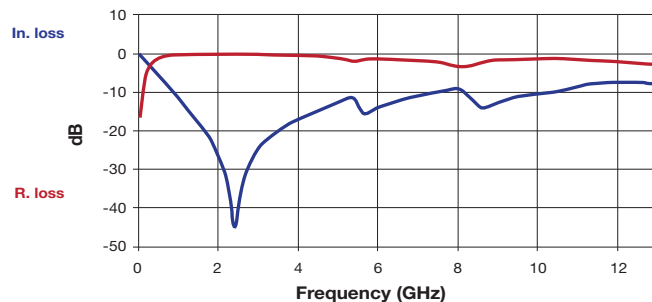

	F (GHz)	IL	R. loss
F1	0.31	-2.90	-2.85
F2	1.28	-15.26	-0.10
F3	2.408	-45.65	-0.10
F4	4.635	-14.90	-0.87
F5	4.897	-12.89	-1.08

RF/Microwave Capacitors

RF/Microwave C0G (NP0) Capacitors

Ultra Low ESR "U" Series, C0G (NP0) Capacitors (RoHS)



GENERAL INFORMATION

"U" Series capacitors are C0G (NP0) chip capacitors specially designed for "Ultra" low ESR for applications in the communications market. Max ESR and effective capacitance are met on each value producing lot to lot uniformity. Sizes available are EIA chip sizes 0603, 0805, and 1210.

DIMENSIONS: inches (millimeters)

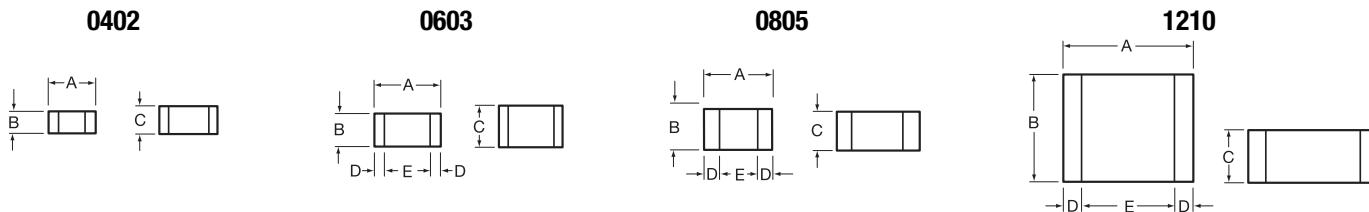

Size	A	B	C	D	E
0402	0.039±0.004 (1.00±0.1)	0.020±0.004 (0.50±0.1)	0.024 (0.6) max	0.010 ± 0.006 (0.25 ± 0.15)	0.014 (0.36) min
0603	0.060±0.010 (1.52±0.25)	0.030±0.010 (0.76±0.25)	0.036 (0.91) max	0.010 ± 0.005 (0.25 ± 0.13)	0.030 (0.76) min
0805	0.079±0.008 (2.01±0.2)	0.049±0.008 (1.25±0.2)	0.045 (1.15mm) max	0.020 ± 0.010 (0.51 ± 0.254)	0.020 (0.51) min
1210	0.126±0.008 (3.2±0.2)	0.098±0.008 (2.49±0.2)	0.055 (1.40mm) max	0.025 ± 0.015 (0.635 ± 0.381)	0.040 (1.02) min

HOW TO ORDER

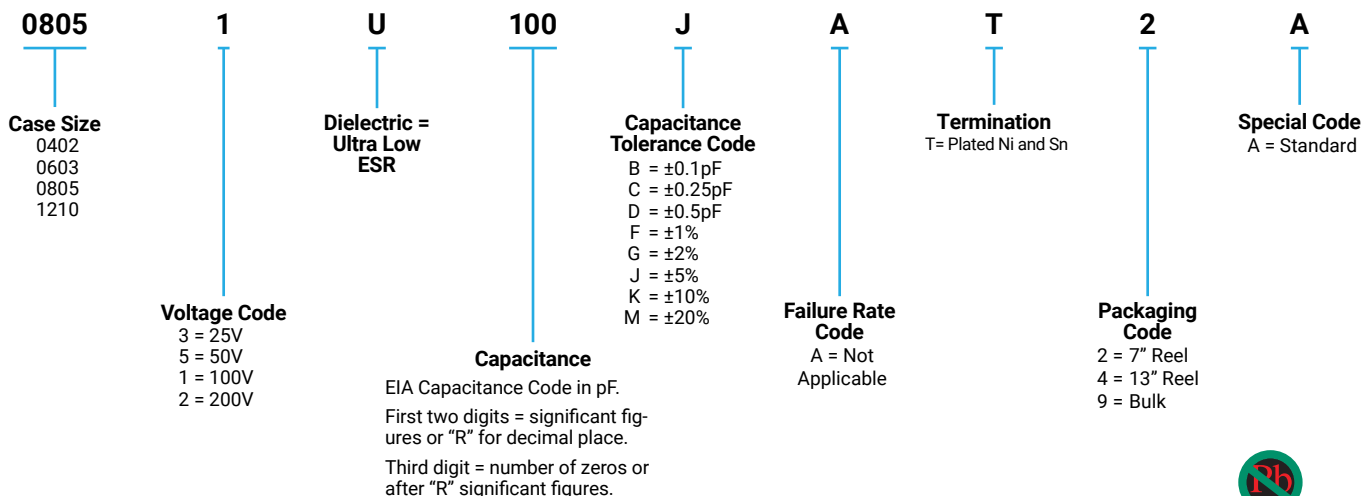

ELECTRICAL CHARACTERISTICS

Capacitance Values and Tolerances:

- Size 0402 - 0.2 pF to 22 pF @ 1 MHz
- Size 0603 - 1.0 pF to 100 pF @ 1 MHz
- Size 0805 - 1.6 pF to 160 pF @ 1 MHz
- Size 1210 - 2.4 pF to 1000 pF @ 1 MHz

Temperature Coefficient of Capacitance (TC):

0±30 ppm/°C (-55° to +125°C)

Insulation Resistance (IR):

- 10¹² Ω min. @ 25°C and rated WVDC
- 10¹¹ Ω min. @ 125°C and rated WVDC

Working Voltage (WVDC):

- | | |
|------|---------------------|
| Size | Working Voltage |
| 0402 | - 50, 25 WVDC |
| 0603 | - 200, 100, 50 WVDC |
| 0805 | - 200, 100 WVDC |
| 1210 | - 200, 100 WVDC |

Dielectric Working Voltage (DWV):

250% of rated WVDC

Equivalent Series Resistance Typical (ESR):

- 0402 - See Performance Curve, page 300
- 0603 - See Performance Curve, page 300
- 0805 - See Performance Curve, page 300
- 1210 - See Performance Curve, page 300

Marking

Laser marking EIA J marking standard (except 0603) (capacitance code and tolerance upon request).



RF/Microwave Capacitors

RF/Microwave C0G (NP0) Capacitors

Ultra Low ESR "U" Series, C0G (NP0) Capacitors (RoHS)



CAPACITANCE RANGE

Cap (pF)	Available Tolerance	Size				Cap (pF)	Available Tolerance	Size				Cap (pF)	Available Tolerance	Size			
		0402	0603	0805	1210			0402	0603	0805	1210			0402	0603	0805	1210
0.2	B,C	50V	N/A	N/A	N/A	1.0	B,C,D	50V	200V	200V	200V	100	FG,J,K,M	N/A	100V	200V	200V
0.3	↓ B,C	↓	↓	↓	↓	1.1	↓	↓	↓	↓	↓	110	↓	↓	↓	↓	↓
0.4						1.2						120					
0.5	B,C	↓	↓	↓	↓	1.3	↓	↓	↓	↓	↓	130	↓	↓	↓	↓	↓
0.6	B,C,D					140											
0.7	B,C,D	↓	↓	↓	↓	1.4	↓	↓	↓	↓	↓	140	↓	↓	↓	↓	↓
0.8	B,C,D					150											
0.9	B,C,D	↓	↓	↓	↓	1.5	↓	↓	↓	↓	↓	160	↓	↓	↓	↓	↓
						1.6						180					
						1.7						200					
						1.8						220					
						1.9						270					
						2.0						300					
						2.1						330					
						2.2						360					
						2.4						390					
						2.7						430					
						3.0						470					
						3.3						510					
						3.6						560					
						3.9						620					
						4.3						680					
						4.7						750					
						5.1						820					
						5.6						910					
						6.2						1000					
						6.8	B,C,D B,C,J,K,M	↓	↓	↓	↓		FG,J,K,M	↓	↓	↓	↓

ULTRA LOW ESR, "U" SERIES

TYPICAL ESR vs. FREQUENCY
0402 "U" SERIES

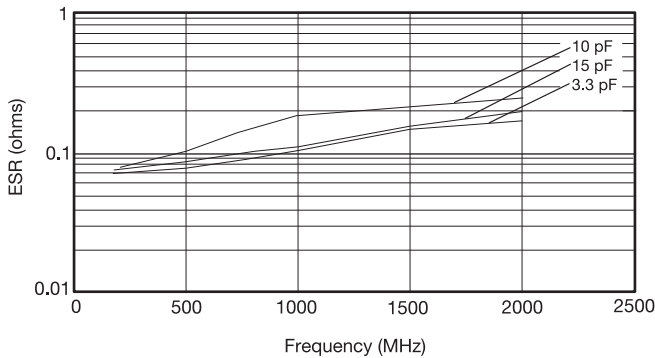

TYPICAL ESR vs. FREQUENCY
0603 "U" SERIES

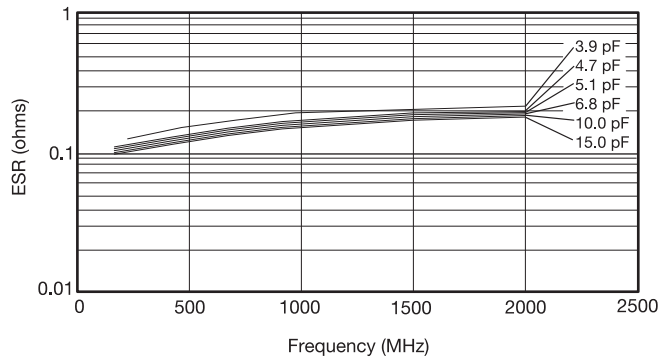

TYPICAL ESR vs. FREQUENCY
0805 "U" SERIES

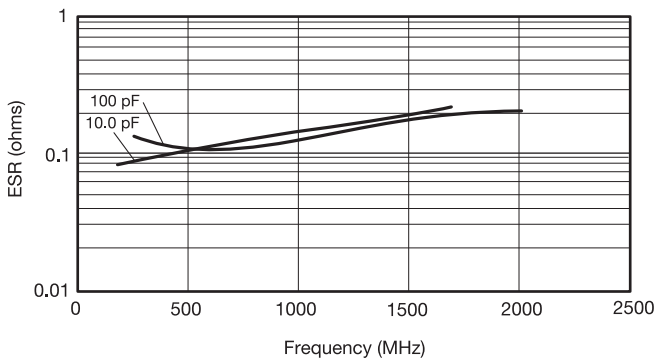

TYPICAL ESR vs. FREQUENCY
1210 "U" SERIES

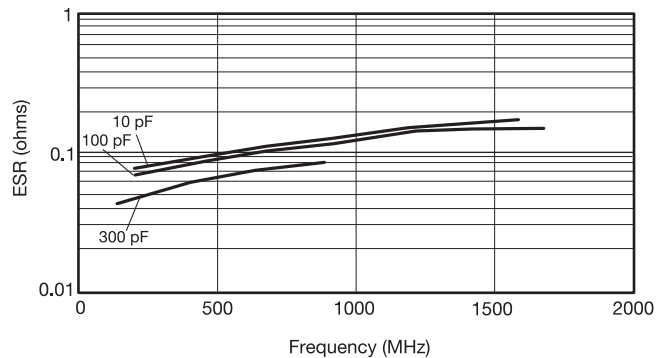

ESR Measured on the Boonton 34A

TYPICAL SERIES RESONANT FREQUENCY "U" SERIES CHIP

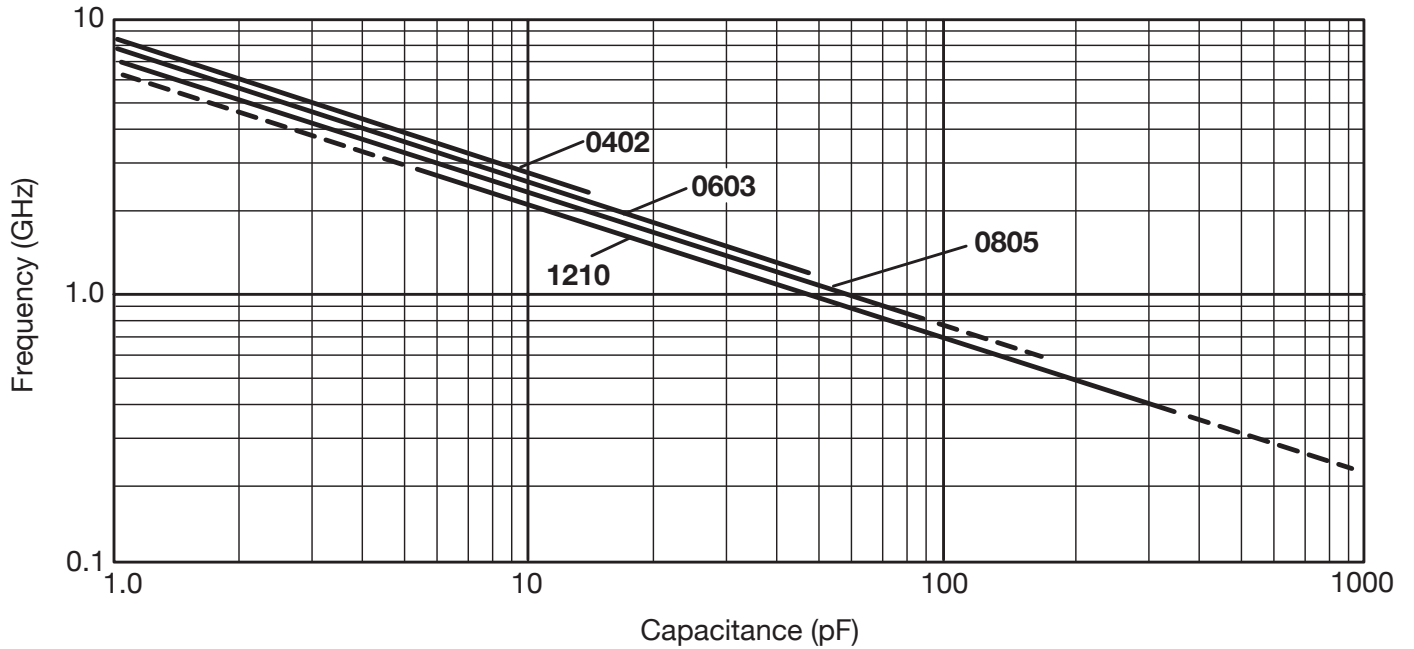

RF/Microwave Capacitors

RF/Microwave C0G (NP0) Capacitors

Ultra Low ESR "U" Series, C0G (NP0) Capacitors (Sn/Pb)



GENERAL INFORMATION

"U" Series capacitors are C0G (NP0) chip capacitors specially designed for "Ultra" low ESR for applications in the communications market. Max ESR and effective capacitance are met on each value producing lot to lot uniformity. Sizes available are EIA chip sizes 0603, 0805, and 1210.

DIMENSIONS: inches (millimeters)

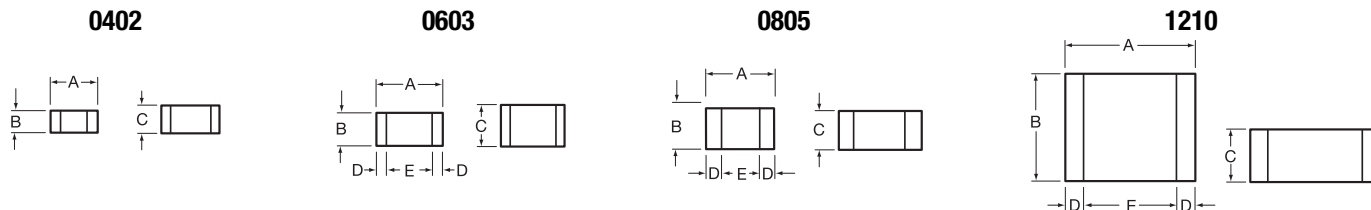

Size	A	B	C	D	E
0402	0.039±0.004 (1.00±0.1)	0.020±0.004 (0.50±0.1)	0.024 (0.6) max	0.010 ± 0.006 (0.25 ± 0.15)	0.014 (0.36) min
0603	0.060±0.010 (1.52±0.25)	0.030±0.010 (0.76±0.25)	0.036 (0.91) max	0.010±0.005 (0.25±0.13)	0.030 (0.76) min
0805	0.079±0.008 (2.01±0.2)	0.049±0.008 (1.25±0.2)	0.045 (1.15mm) max	0.020±0.010 (0.51±0.254)	0.020 (0.51) min
1210	0.126±0.008 (3.2±0.2)	0.098±0.008 (2.49±0.2)	0.055 (1.40mm) max	0.025±0.015 (0.635±0.381)	0.040 (1.02) min

HOW TO ORDER

LD05
Case Size
LD02 = 0402
LD03 = 0603
LD05 = 0805
LD10 = 1210

1
Voltage Code
3 = 25V
5 = 50V
1 = 100V
2 = 200V

U
Dielectric =
Ultra Low
ESR

100
Capacitance
EIA Capacitance Code in pF.
First two digits = significant figures or "R" for decimal place.
Third digit = number of zeros or after "R" significant figures.

J
Capacitance
Tolerance Code
B = ±0.1pF
C = ±0.25pF
D = ±0.5pF
F = ±1%
G = ±2%
J = ±5%
K = ±10%
M = ±20%

A
Failure Rate
Code
A = Not
Applicable

B
Termination
B = 5% min lead

2
Packaging
Code
2 = 7" Reel
4 = 13" Reel
9 = Bulk

A
Special Code
A = Standard

Not RoHS Compliant

ELECTRICAL CHARACTERISTICS

Capacitance Values and Tolerances:

Size 0402 - 0.2 pF to 22 pF @ 1 MHz
Size 0603 - 1.0 pF to 100 pF @ 1 MHz
Size 0805 - 1.6 pF to 160 pF @ 1 MHz
Size 1210 - 2.4 pF to 1000 pF @ 1 MHz

Temperature Coefficient of Capacitance (TC):

0±30 ppm/°C (-55° to +125°C)

Insulation Resistance (IR):

10¹² Ω min. @ 25°C and rated WVDC
10¹¹ Ω min. @ 125°C and rated WVDC

Working Voltage (WVDC):

Size Working Voltage
0402 - 50, 25 WVDC
0603 - 200, 100, 50 WVDC
0805 - 200, 100 WVDC
1210 - 200, 100 WVDC

Dielectric Working Voltage (DWV):

250% of rated WVDC

Equivalent Series Resistance Typical (ESR):

040 - See Performance Curve, page 306
0603 - See Performance Curve, page 306
0805 - See Performance Curve, page 306
1210 - See Performance Curve, page 306

Marking:

Laser marking EIA J marking standard (except 0603) (capacitance code and tolerance upon request).

Military Specifications

Meets or exceeds the requirements of MIL-C-55681

RF/Microwave Capacitors

RF/Microwave C0G (NP0) Capacitors

Ultra Low ESR "U" Series, C0G (NP0) Capacitors (Sn/Pb)



CAPACITANCE RANGE

Cap (pF)	Available Tolerance	Size			
		LD02	LD03	LD05	LD10
0.2	B,C	50V	N/A	N/A	N/A
0.3	↓	↓	↓	↓	↓
0.4	↓	↓	↓	↓	↓
0.5	B,C	↓	↓	↓	↓
0.6	B,C,D	↓	↓	↓	↓
0.7	↓	↓	↓	↓	↓
0.8	↓	↓	↓	↓	↓
0.9	B,C,D	↓	↓	↓	↓

Cap (pF)	Available Tolerance	Size			
		LD02	LD03	LD05	LD10
1.0	B,C,D	50V	200V	200V	200V
1.1	↓	↓	↓	↓	↓
1.2	↓	↓	↓	↓	↓
1.3	↓	↓	↓	↓	↓
1.4	↓	↓	↓	↓	↓
1.5	↓	↓	↓	↓	↓
1.6	↓	↓	↓	↓	↓
1.7	↓	↓	↓	↓	↓
1.8	↓	↓	↓	↓	↓
1.9	↓	↓	↓	↓	↓
2.0	↓	↓	↓	↓	↓
2.1	↓	↓	↓	↓	↓
2.2	↓	↓	↓	↓	↓
2.4	↓	↓	↓	↓	↓
2.7	↓	↓	↓	↓	↓
3.0	↓	↓	↓	↓	↓
3.3	↓	↓	↓	↓	↓
3.6	↓	↓	↓	↓	↓
3.9	↓	↓	↓	↓	↓
4.3	↓	↓	↓	↓	↓
4.7	↓	↓	↓	↓	↓
5.1	↓	↓	↓	↓	↓
5.6	↓	↓	↓	↓	↓
6.2	↓	↓	↓	↓	↓
6.8	B,C,D B,C,J,K,M	↓	↓	↓	↓

Cap (pF)	Available Tolerance	Size			
		LD02	LD03	LD05	LD10
7.5	B,C,J,K,M	50V	200V	200V	200V
8.2	↓	↓	↓	↓	↓
9.1	B,C,J,K,M	↓	↓	↓	↓
10	F,G,J,K,M	↓	↓	↓	↓
11	↓	↓	↓	↓	↓
12	↓	↓	↓	↓	↓
13	↓	↓	↓	↓	↓
15	↓	↓	↓	↓	↓
18	↓	↓	↓	↓	↓
20	↓	↓	↓	↓	↓
22	↓	↓	↓	↓	↓
24	↓	↓	↓	↓	↓
27	↓	↓	↓	↓	↓
30	↓	↓	↓	↓	↓
33	↓	↓	↓	↓	↓
36	↓	↓	↓	↓	↓
39	↓	↓	↓	↓	↓
43	↓	↓	↓	↓	↓
47	↓	↓	↓	↓	↓
51	↓	↓	↓	↓	↓
56	↓	↓	↓	↓	↓
68	↓	↓	↓	↓	↓
75	↓	↓	↓	↓	↓
82	↓	↓	↓	↓	↓
91	↓	↓	↓	↓	↓

Cap (pF)	Available Tolerance	Size			
		LD02	LD03	LD05	LD10
100	F,G,J,K,M	N/A	100V	200V	200V
110	↓	↓	↓	↓	↓
120	↓	↓	↓	↓	↓
130	↓	↓	↓	↓	↓
140	↓	↓	↓	↓	↓
150	↓	↓	↓	↓	↓
160	↓	↓	↓	↓	↓
180	↓	↓	↓	↓	↓
200	↓	↓	↓	↓	↓
220	↓	↓	↓	↓	↓
270	↓	↓	↓	↓	↓
300	↓	↓	↓	↓	↓
330	↓	↓	↓	↓	↓
360	↓	↓	↓	↓	↓
390	↓	↓	↓	↓	↓
430	↓	↓	↓	↓	↓
470	↓	↓	↓	↓	↓
510	↓	↓	↓	↓	↓
560	↓	↓	↓	↓	↓
620	↓	↓	↓	↓	↓
680	↓	↓	↓	↓	↓
750	↓	↓	↓	↓	↓
820	↓	↓	↓	↓	↓
910	↓	↓	↓	↓	↓
1000	F,G,J,K,M	↓	↓	↓	↓

ULTRA LOW ESR, "U" SERIES

TYPICAL ESR vs. FREQUENCY
0402 "U" SERIES

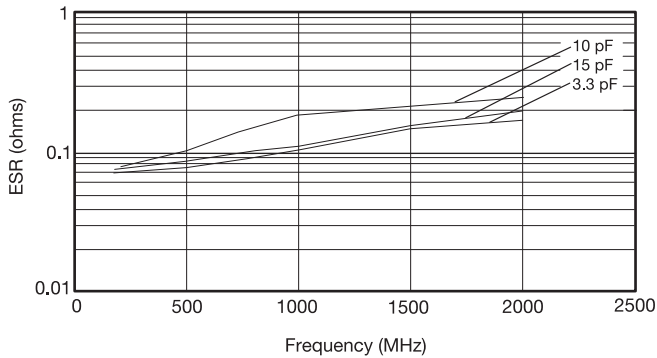

TYPICAL ESR vs. FREQUENCY
0603 "U" SERIES

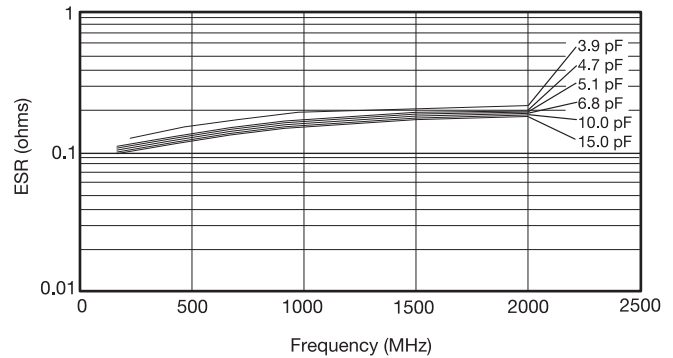

TYPICAL ESR vs. FREQUENCY
0805 "U" SERIES

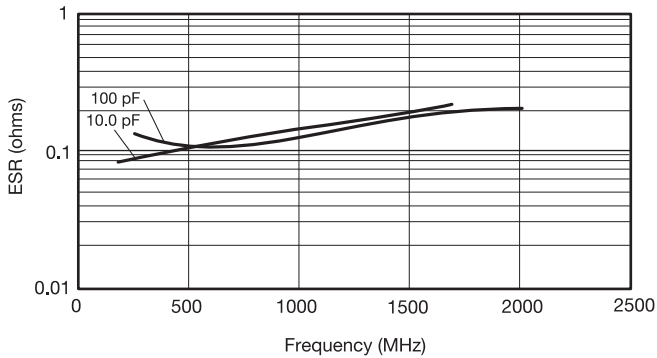

TYPICAL ESR vs. FREQUENCY
1210 "U" SERIES

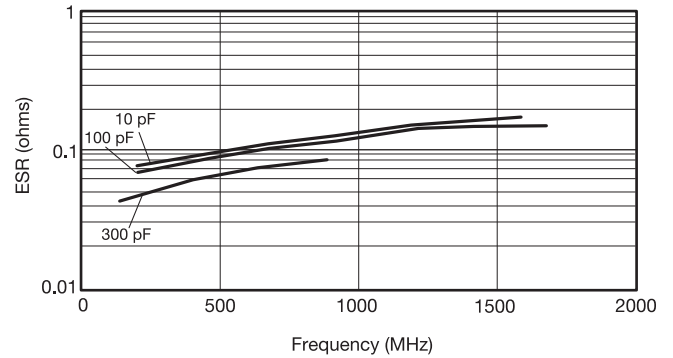

ESR Measured on the Boonton 34A

TYPICAL
 SERIES RESONANT FREQUENCY
 "U" SERIES CHIP

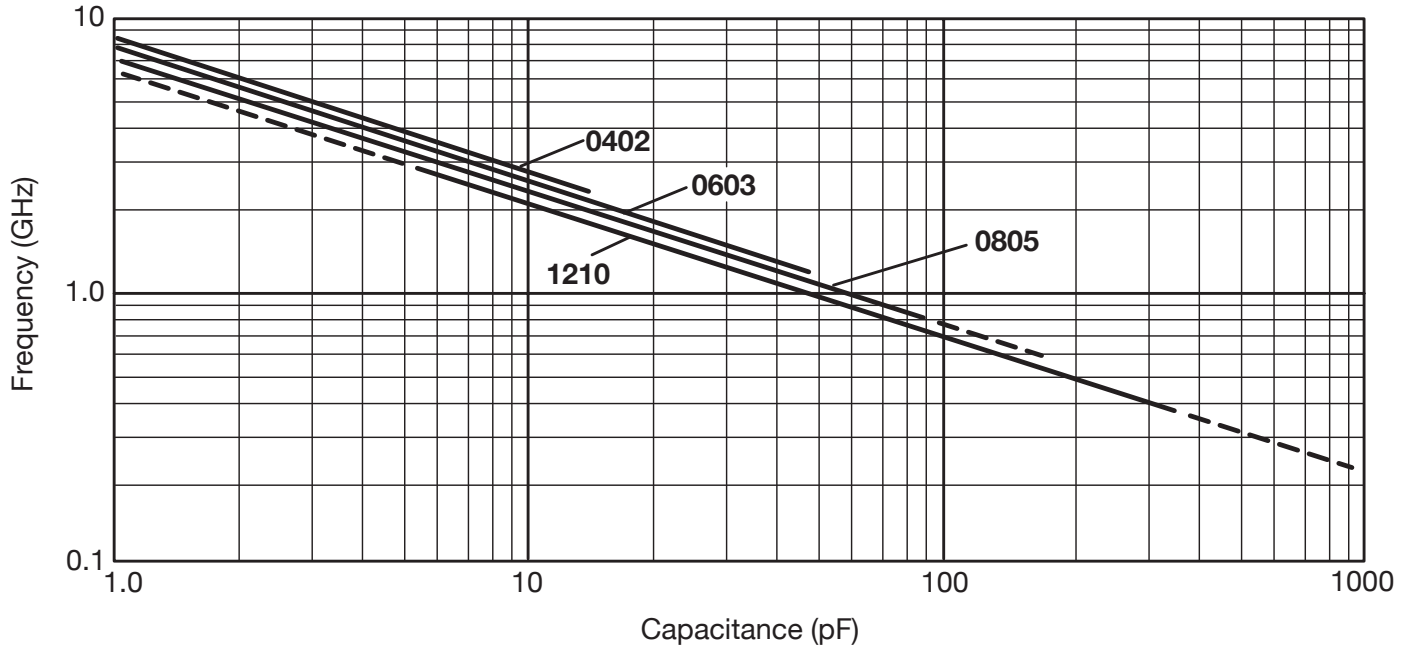

RF/Microwave Capacitors

RF/Microwave C0G (NP0) Capacitors

Ultra Low ESR "U" Series, C0G (NP0) Capacitors (RoHS)

Automotive, AEC Q200 Qualified



GENERAL INFORMATION

Automotive "U" Series capacitors are C0G (NP0) chip capacitors specially designed for "Ultra" low ESR for applications in the automotive market. Max ESR and effective capacitance are met on each value producing lot to lot uniformity. Sizes available are EIA chip sizes 0402 and 0603.

DIMENSIONS: inches (millimeters)

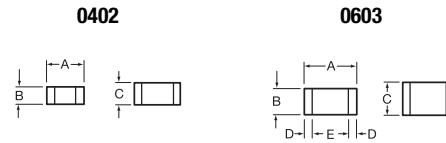

	inches (mm)				
Size	A	B	C	D	E
0402	0.039±0.004 (1.00±0.1)	0.020±0.004 (0.50±0.1)	0.024 max (0.6)	N/A	N/A
0603	0.060±0.010 (1.52±0.25)	0.030±0.010 (0.76±0.25)	0.036 max (0.91)	0.010±0.005 (0.25±0.13)	0.030 min (0.76)

HOW TO ORDER

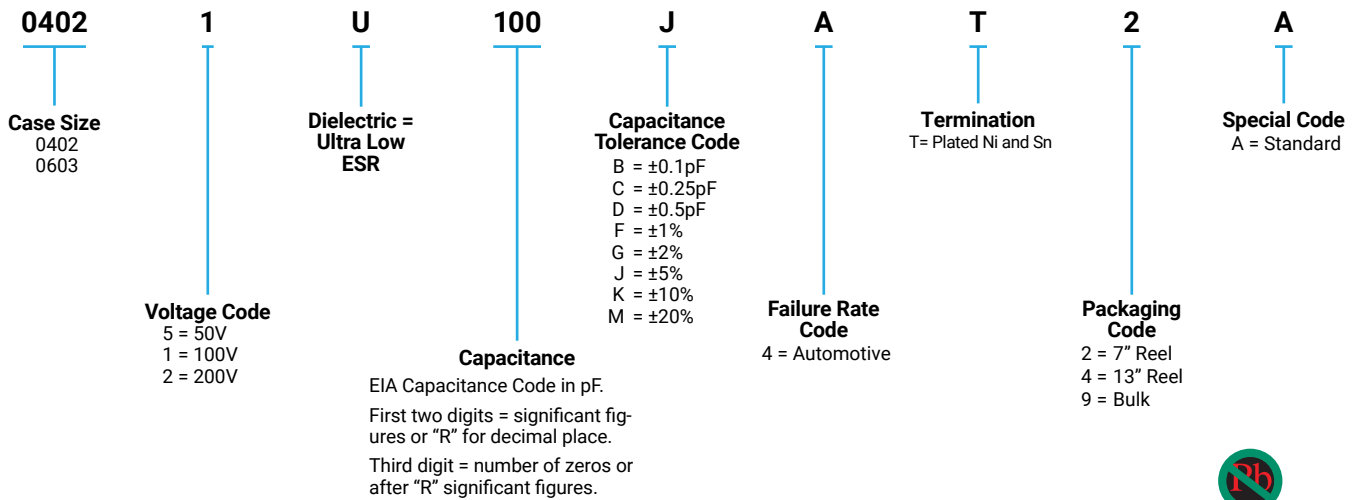

ELECTRICAL CHARACTERISTICS

Capacitance Values and Tolerances:

Size 0402 - 0.2 pF to 22 pF @ 1 MHz
Size 0603 - 1.0 pF to 100 pF @ 1 MHz

Temperature Coefficient of Capacitance (TC):

0±30 ppm/°C (-55° to +125°C)

Insulation Resistance (IR):

10¹² Ω min. @ 25°C and rated WVDC
10¹¹ Ω min. @ 125°C and rated WVDC

Working Voltage (WVDC):

Size	Working Voltage
0402	- 100, 50, 25 WVDC
0603	- 200, 100, 50 WVDC

Dielectric Working Voltage (DWV):

250% of rated WVDC

Equivalent Series Resistance Typical (ESR):

0402 - See Performance Curve, page 303
0603 - See Performance Curve, page 303

Automotive Specifications

Meets or exceeds the requirements of AEC Q200



LEAD-FREE
LEAD-FREE COMPATIBLE
COMPONENT



RF/Microwave Capacitors
RF/Microwave C0G (NP0) Capacitors
Ultra Low ESR "U" Series, C0G (NP0) Capacitors (RoHS)
Automotive, AEC Q200 Qualified



CAPACITANCE RANGE

Cap (pF)	Available Tolerance	Size 0402	Size 0603
0.2	B,C	50V	N/A
0.3			
0.4			
0.5	B,C		
0.6	B,C,D		
0.7			
0.8	B,C,D		
0.9			

Cap (pF)	Available Tolerance	Size 0402	Size 0603
1.0	B,C,D	50V	200V
1.1			
1.2			
1.3			
1.4			
1.5			
1.6			
1.7			
1.8			
1.9			
2.0			
2.1			
2.2			
2.4			
2.7			
3.0			
3.3			
3.6			
3.9			
4.3			
4.7			
5.1			
5.6			
6.2	B,C,D		
6.8	B,C,J,K,M		

Cap (pF)	Available Tolerance	Size 0402	Size 0603
7.5	B,C,J,K,M	50V	200V
8.2			
9.1	B,C,J,K,M		
10	F,G,J,K,M		
11			
12			
13			
15			
18			
20			200V 100V
22			
24			
27			
30		50V N/A	
33			
36			
39			
43			
47			
51			
56			
68			
75			
82			
91			

Cap (pF)	Available Tolerance	Size 0402	Size 0603
100	F,G,J,K,M	N/A	100V
110			50V
120			50V
130			N/A
140			
150			
160			
180			
200			
220			
270			
300			
330			
360			
390			
430			
470			
510			
560			
620			
680			
750			
820			
910			
1000	F,G,J,K,M		

ULTRA LOW ESR, "U" SERIES

TYPICAL ESR vs. FREQUENCY
0402 "U" SERIES

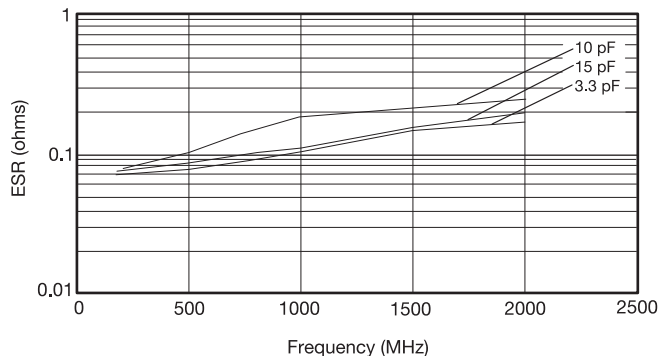

TYPICAL ESR vs. FREQUENCY
0603 "U" SERIES

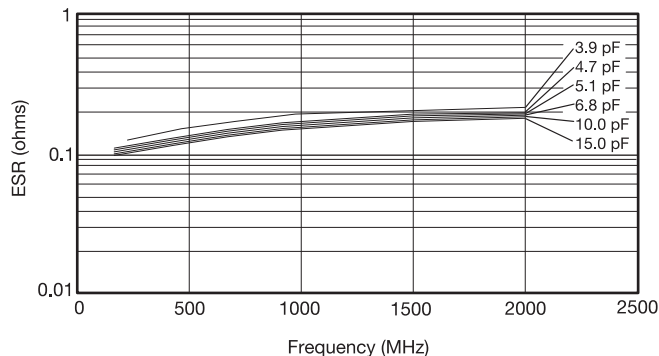

TYPICAL SERIES RESONANT FREQUENCY
"U" SERIES CHIP

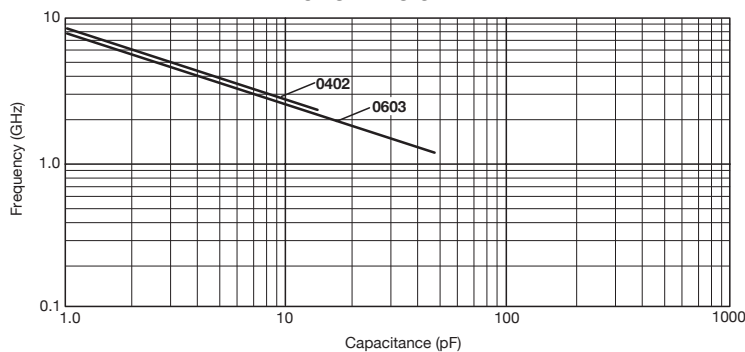

0402

Kit 5000 UZ			
Cap. Value PF	Tolerance	Cap. Value pF	Tolerance
0.5	B ($\pm 0.1\text{pF}$)	4.7	B ($\pm 0.1\text{pF}$)
1.0		5.6	
1.5		6.8	
1.8		8.2	
2.2		10.0	
2.4		12.0	
3.0	J ($\pm 5\%$)	15.0	J ($\pm 5\%$)
3.6			

***25 each of 15 values

0603

Kit 4000 UZ			
Cap. Value PF	Tolerance	Cap. Value pF	Tolerance
1.0	B ($\pm 0.1\text{pF}$)	6.8	B ($\pm 0.1\text{pF}$)
1.2		7.5	
1.5		8.2	
1.8		10.0	
2.0		12.0	
2.4		15.0	
2.7	J ($\pm 5\%$)	18.0	J ($\pm 5\%$)
3.0		22.0	
3.3		27.0	
3.9		33.0	
4.7		39.0	
5.6		47.0	

***25 each of 24 values

0805

Kit 3000 UZ			
Cap. Value PF	Tolerance	Cap. Value pF	Tolerance
1.0	B ($\pm 0.1\text{pF}$)	15.0	J ($\pm 5\%$)
1.5		18.0	
2.2		22.0	
2.4		24.0	
2.7		27.0	
3.0		33.0	
3.3		36.0	
3.9		39.0	
4.7		47.0	
5.6		56.0	
7.5		68.0	
8.2		82.0	
10.0		J ($\pm 5\%$)	
12.0	130.0		

***25 each of 30 values

1210

Kit 3500 UZ			
Cap. Value PF	Tolerance	Cap. Value pF	Tolerance
2.2	B ($\pm 0.1\text{pF}$)	36.0	J ($\pm 5\%$)
2.7		39.0	
4.7		47.0	
5.1		51.0	
6.8		56.0	
8.2		68.0	
9.1		82.0	
10.0		J ($\pm 5\%$)	
13.0	120.0		
15.0	130.0		
18.0	240.0		
20.0	300.0		
24.0	390.0		
27.0	470.0		
30.0	680.0		

***25 each of 30 values



FOLLOW US:     

VISIT US AT WWW.KYOCERA-AVX.COM 

A light gray world map is centered in the background of the lower half of the page. It shows the outlines of continents and major landmasses.

North America

Tel: +1 864-967-2150

Europe

Tel: +44 1276-697000

Asia

Tel: +65 6286-7555

Central America

Tel: +55 11-46881960

Japan

Tel: +81 740-321250