

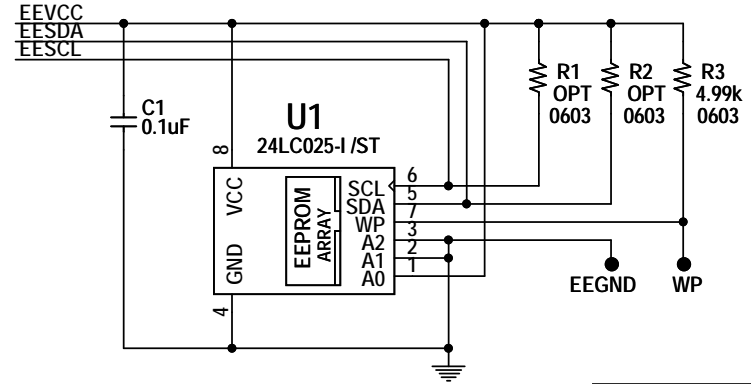

REVISION HISTORY				
ECO	REV	DESCRIPTION	APPROVED	DATE
—	1	1ST PROTOTYPE	MARK T.	05-22-14

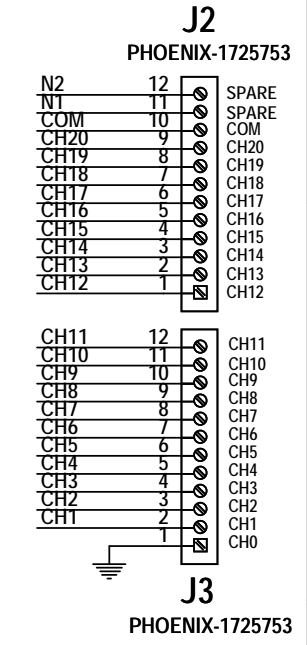
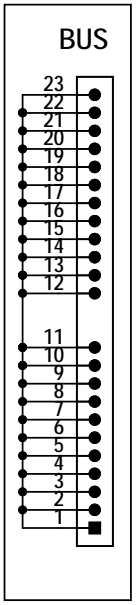
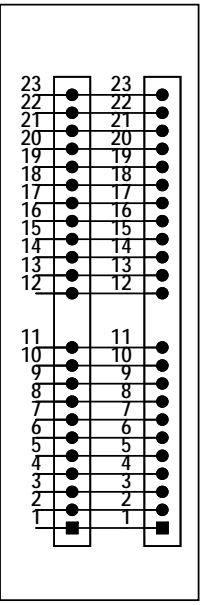
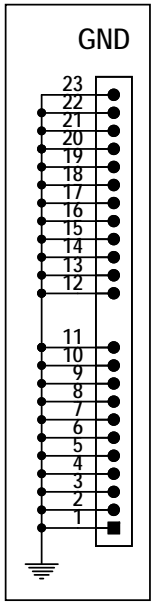
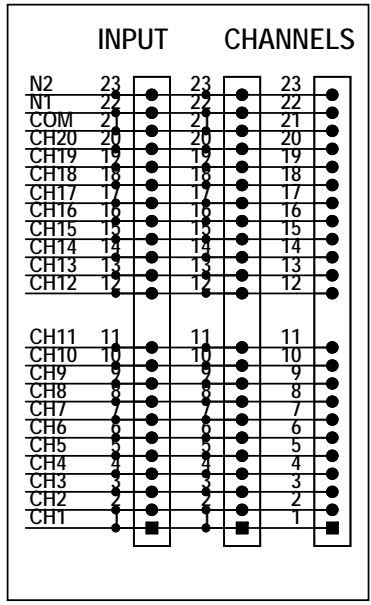
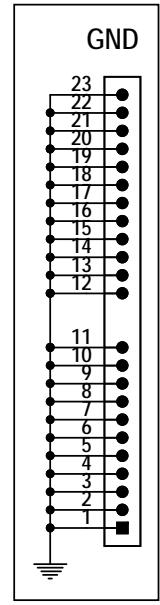
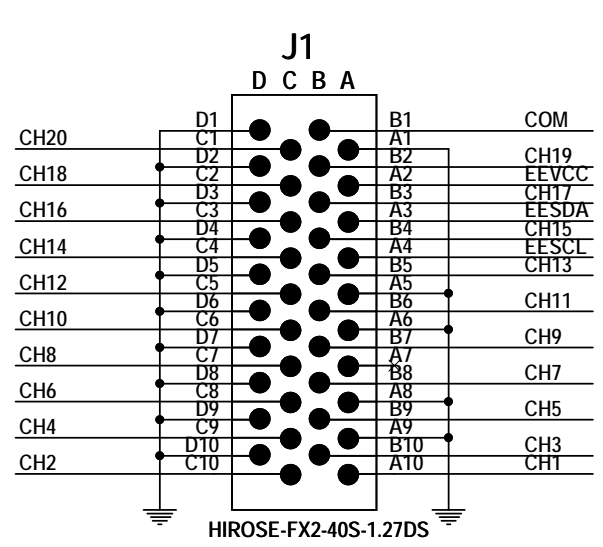

**NOTE: UNLESS OTHERWISE SPECIFIED**

1. ALL CAPACITORS ARE IN MICROFARADS, 0603.
2. ALL RESISTORS ARE IN OHMS, THROUGH HOLE.

CUSTOMER NOTICE		APPROVALS		 1630 McCarthy Blvd. Milpitas, CA 95035 Phone: (408)432-1900 www.linear.com Fax: (408)434-0507 LTC Confidential-For Customer Use Only	
LINEAR TECHNOLOGY HAS MADE A BEST EFFORT TO DESIGN A CIRCUIT THAT MEETS CUSTOMER-SUPPLIED SPECIFICATIONS; HOWEVER, IT REMAINS THE CUSTOMER'S RESPONSIBILITY TO VERIFY PROPER AND RELIABLE OPERATION IN THE ACTUAL APPLICATION. COMPONENT SUBSTITUTION AND PRINTED CIRCUIT BOARD LAYOUT MAY SIGNIFICANTLY AFFECT CIRCUIT PERFORMANCE OR RELIABILITY. CONTACT LINEAR TECHNOLOGY APPLICATIONS ENGINEERING FOR ASSISTANCE.		PCB DES.	KIM T.	TITLE: SCHEMATIC	
THIS CIRCUIT IS PROPRIETARY TO LINEAR TECHNOLOGY AND SUPPLIED FOR USE WITH LINEAR TECHNOLOGY PARTS.		APP ENG.	MARK T.		
SCALE = NONE		SIZE	N/A	IC NO.	<b>EXPERIMENTER BOARD</b>  <b>DEMO CIRCUIT 2210A</b>
		DATE:	05/22/2014, 09:27 AM	REV.	1
		SHEET 1 OF 1			