



PiezoListen™

For general use

Piezo Speakers

PHUA6630-076B-00-000

PHUA3030-049B-00-000

PHUA3015-049B-00-000

PHUA2010-049B-00-000

REMINDERS FOR USE AND SAFETY

Please pay sufficient attention to the warnings for safe designing when using this products.

REMINDERS

- In use of this product, it should be minded by notes and please perform a safety design, after checking the individual standard for every unit enough.
- Please do not apply DC bias to the product. It will cause the insulation resistance to degrade and result in malfunction.
- There is a risk of performance degradation, adhere to the following matters.
 - Please keep the product in an environment without any drastic temperature change, condensation, direct sunlight, corrosive gases and dust, and do not remove the packaging until use to avoid any load stress.
 - Use the product within six month.
 - Do not apply strong shocks (fall etc.) or pressure by which a crack goes into a product.
 - Do not supply any voltage higher than applicable to the product.
 - Do not use the piezoelectric buzzer outdoors. It is designed for indoor use.
 - Do not apply the temperature more than 150°C.
- When designing your equipment even for general-purpose applications, you are kindly requested to take into consideration securing protection circuit/device or providing backup circuits in your equipment.
- Please refrain from cleaning the product in ways that it will be exposed to solvent or gas.
- Please do not touch the piezoelectric element with bare hand. It may cause corrosion or discharge of electricity to your hand.
- Please discharge the product before connecting to measuring instruments.
- When soldering, please be careful that the piezoelectric element is kept clean from flux and other foreign substance.
- When soldering the terminal, please make sure that there is no dirt or rust to avoid contact failures.
- If the product is to be attached with adhesives, please consider the adequate type, quantity and adhesion of the adhesive material used and check before use with conducting reliability evaluation test.
- Please do not use this product if the application device's design exposes the actuator itself for consumers to touch.
- Please do not reprocess the product.
- Characteristics may change depending on the attachment location and form. Check the mounted condition.
- Please take appropriate measures such as acquiring protective circuits and devices that meet the uses, applications, and conditions of the instruments and keeping backup circuits.
- Please understand that we are not responsible for any damage or liability caused by use of the product in any of the applications below or for any other use exceeding the range or conditions set forth in this data sheet.
 - Applications with very stringent safety standard and reliability requirement
 - Applications that any malfunction, trouble, or failure of the product could cause serious damage to the life, body or property of a person
 - Applications that any malfunction, trouble, or failure of the product could cause severe impact to the society (such as automobiles, airplanes, medical instruments, nuclear devices)
- Do not use it in the following environments
 - Corrosive gases (Cl₂, NH₃, H₂S, SO_x, NO_x, etc.)
 - Environments with highly conductive substances (electrolytes, water, saltwater, etc.)
 - Environments with acid, alkali, or organic solvents
 - Places to be exposed to dust.
- Please keep the piezoelectric element away from water or any other material with moisture.
- This is a test sample, so please don't use it as a mass-produced product for customers.

PiezoListen™

Piezo Speakers

Summary

FEATURES

- It is thin and can support various application.
- Immersive onscreen sound.
- Excellent response.
- Wide range of driving voltage.

APPLICATIONS

Television , PC , Smartphone etc.

DRIVE CIRCUIT BLOCK DIAGRAM

Discrete

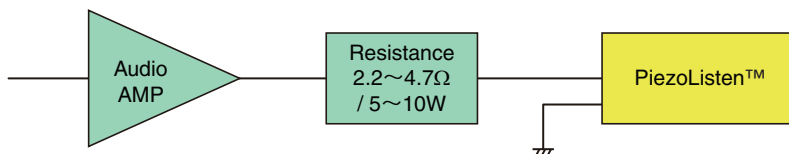

How to install

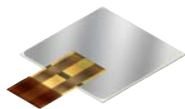

- PiezoListen
Front side
(FPC attached)

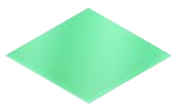

- Double side tape
(ex. Nitto 5000 or 510)

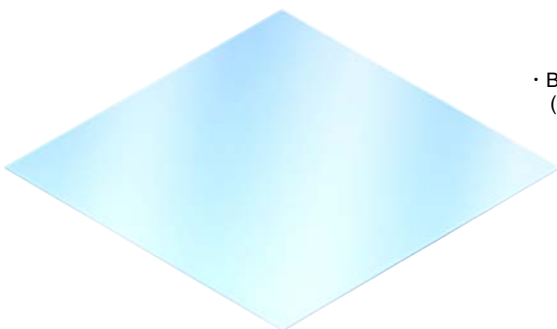

- Back side of panel
(ex. Display)

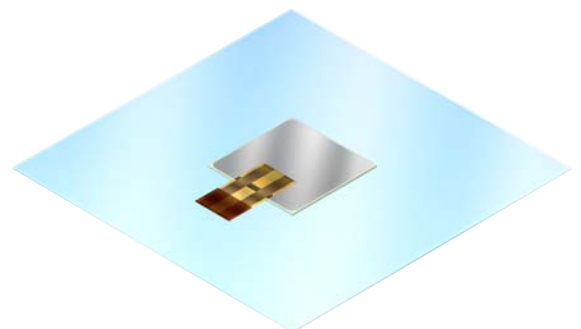



Overview of the Piezo Speaker PHU series

■ PART NUMBER CONSTRUCTION

PHU	A	3030	-	049	B	-	00-000	
Series name	Application		Element dimensions (LxW)		Thickness		Type	Internal code
	A	General use	3030	30x30mm	49	0.49mm	B	FPC
	B	Automotive application (UnderDevelopment)						

■ PRODUCT LINEUP

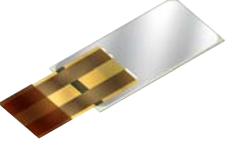
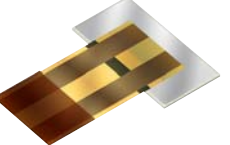
Part No.	PHUA6630-076B-00-000	PHUA3030-049B-00-000	PHUA3015-049B-00-000	PHUA2010-049B-00-000	
					
Dimensions	Product (mm)	79x30x0.96	43x30x0.69	43x15x0.69	20x26.5x0.69
	Element (mm)	66x30x0.76	30x30x0.49	30x15x0.49	20x10x0.49
Electrode	FPC	FPC	FPC	FPC	FPC

■ ELECTRODE SPECIFICATION

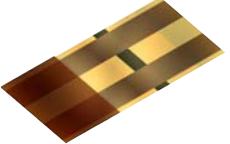
FPC	
Width	12mm
Insulation length	14.5mm
Lead pitch	7.0mm
Stripping length	5.0mm
Reinforcement	8.0mm

PHUA6630-076B-00-000

SHAPE & DIMENSIONS

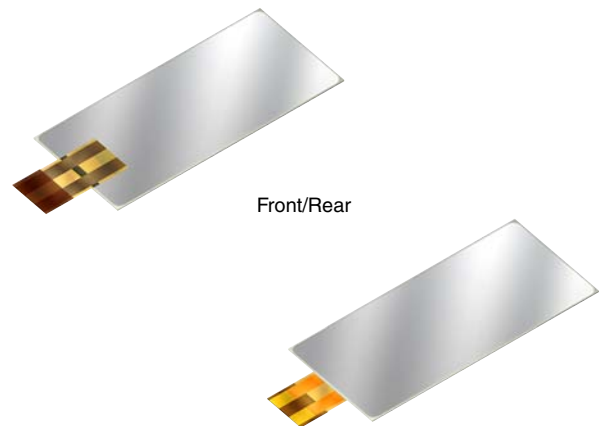
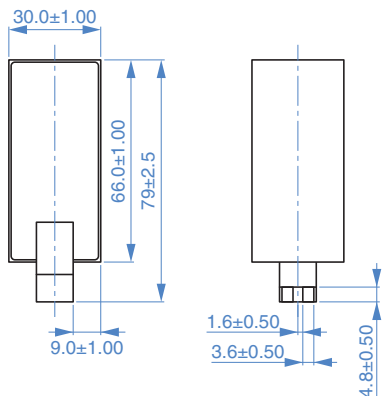

SPECIFICATIONS

Dimensions	Element	66x30x0.76 mm
Electrode		FPC (23.5x12x0.3 mm)
Operating voltage range(max.)		48Vp-p(±24V)max
Operating temperature range		-10 to 60°C

ELECTRICAL CHARACTERISTICS

Capacitance: C	(7.8uF±30%,1kHz,1V)
Current consumption:	2400mA _{p-p} (±1200mA)
mA(p-p) / mA(RMS)	/ 870mA (Drive @ 48Vp-p, 1kHz)

FREQUENCY CHARACTERISTICS (Reference value)

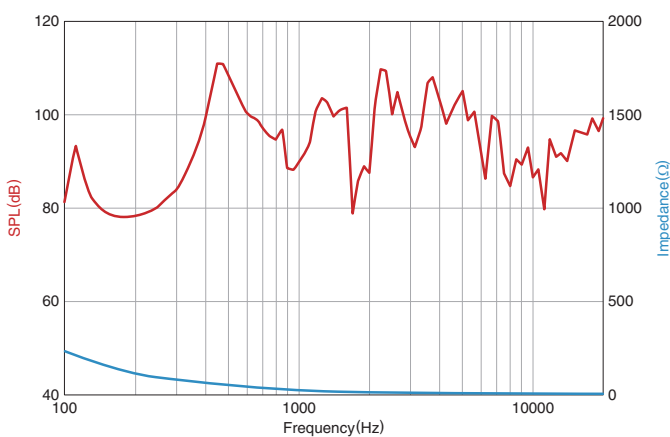

Measurement condition	
Input voltage	12V _{P-P} (±6V)
Distance	10cm to mic
Frequency	400 to 20kHz
Fixed	Glass 220x220x0.7mm (* Refer to The following figure)

* Glass fixing



PHUA6630-076B-00-000

■ PACKAGING STYLE/PACKING NUMBER/MINIMUM ORDERING UNIT

	PHUA6630-076B-00-000 
Packaging style	Bulk (Tray)
Package quantity	90 pieces / corrugated cardboard (5 trays containing 18 pieces)
Minimum ordering unit	90 pieces (1 boxes of corrugated cardboard containing 90 piece)

□ Tray

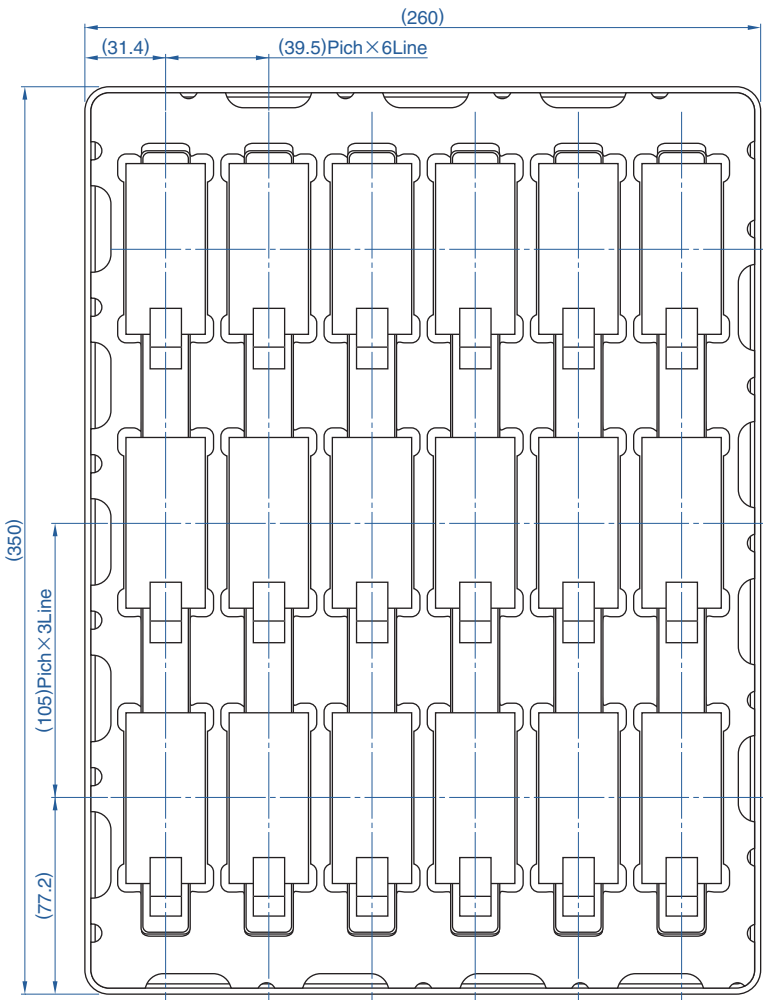

⚠ Please be sure to request delivery specifications that provide further details on the features and specifications of the products for proper and safe use.
Please note that the contents may change without any prior notice due to reasons such as upgrading.

PHUA3030-049B-00-000

SHAPE & DIMENSIONS

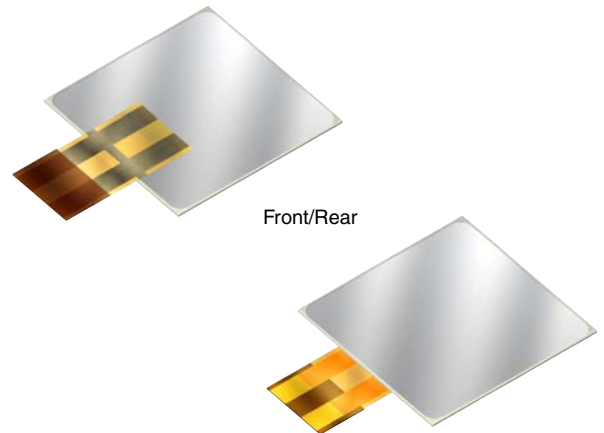
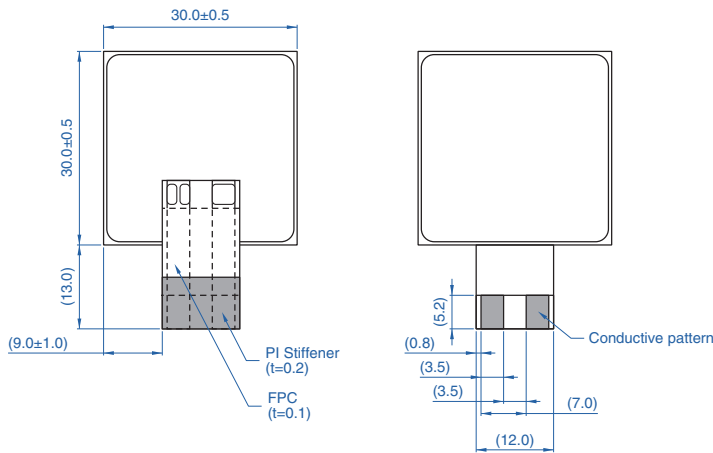

SPECIFICATIONS

Dimensions	Element	30×30×0.49mm
Electrode		FPC (23.5×12×0.3mm)
Operating voltage range(max.)		24Vp-p(±12V)max.
Operating temperature range		-10 to 60°C

ELECTRICAL CHARACTERISTICS

Capacitance: C	(4.8uF±30%)
Current consumption: mA(p-p) / mA(RMS)	900mA p-p(±450mA) / 320mA (Drive @24Vp-p, 1kHz)

FREQUENCY CHARACTERISTICS (Reference value)

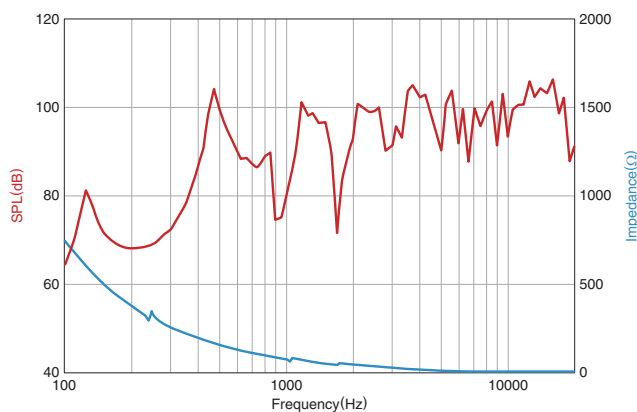

Measurement condition	
Input voltage	12Vp-p(±6V)
Distance	10cm to mic
Frequency	400 to 20kHz
Fixed	Glass 220x220x0.7mm (* Refer to The following figure)

* Glass fixing

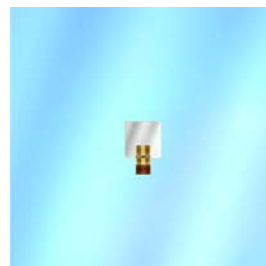

⚠ Please be sure to request delivery specifications that provide further details on the features and specifications of the products for proper and safe use.
Please note that the contents may change without any prior notice due to reasons such as upgrading.

PHUA3030-049B-00-000

■ PACKAGING STYLE/PACKING NUMBER/MINIMUM ORDERING UNIT

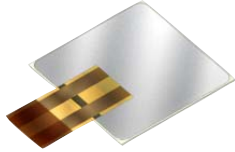
	PHUA3030-049B-00-000 
Packaging style	Bulk (Tray)
Package quantity	200 pieces / corrugated cardboard (5 trays containing 40 pieces)
Minimum ordering unit	200 pieces (1 boxes of corrugated cardboard containing 200 piece)

□ Tray

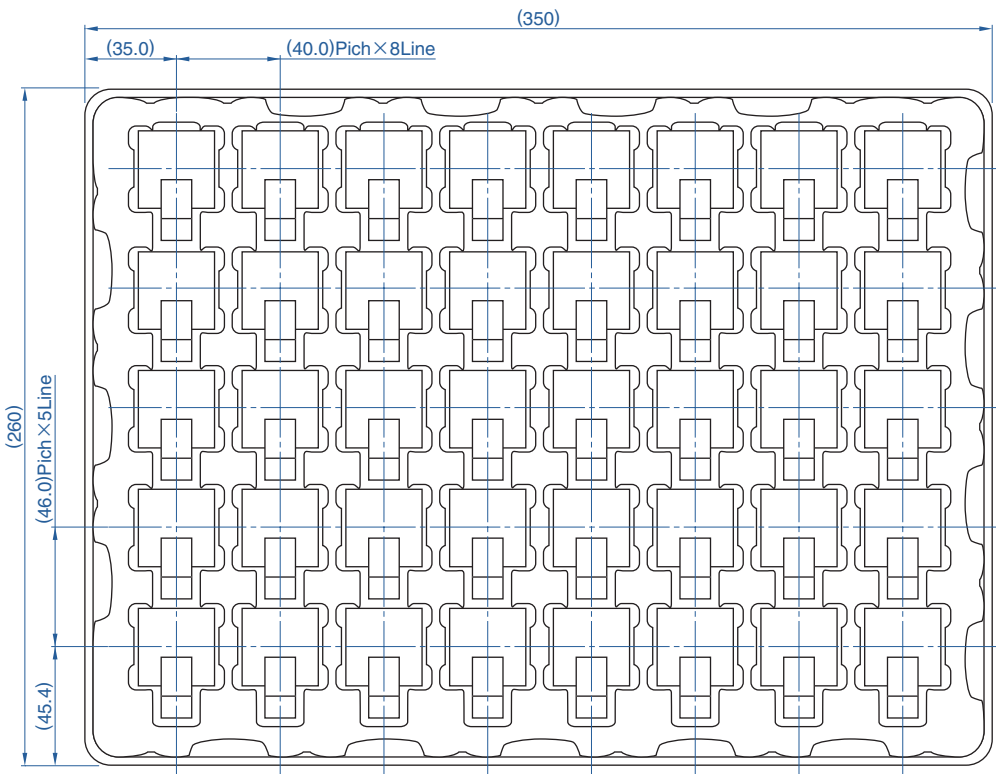

⚠ Please be sure to request delivery specifications that provide further details on the features and specifications of the products for proper and safe use.
Please note that the contents may change without any prior notice due to reasons such as upgrading.

PHUA3015-049B-00-000

SHAPE & DIMENSIONS

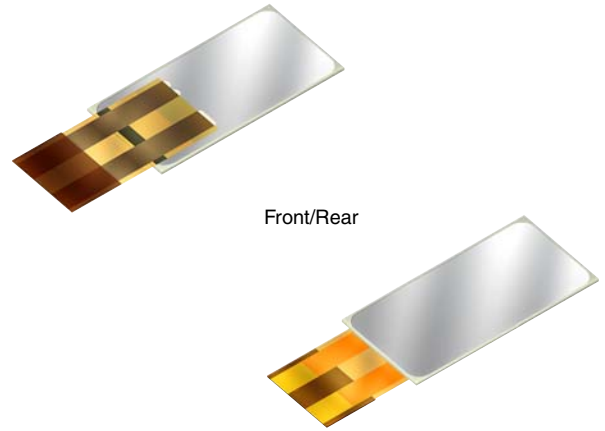
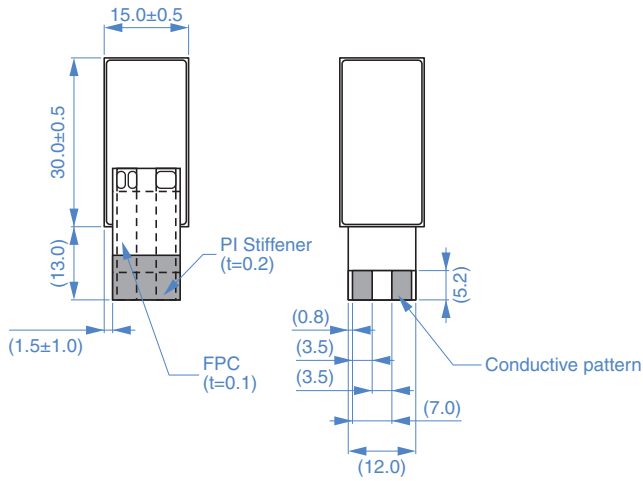

SPECIFICATIONS

Dimensions	Element	30x15x0.49 mm
Electrode		FPC (23.5x12x0.3 mm)
Operating voltage range(max.)		24Vp-p(±12V)max
Operating temperature range		-10 to 60°C

ELECTRICAL CHARACTERISTICS

Capacitance: C	(2.3uF±30%,1kHz,1V)
Current consumption:	450mA _{p-p} (±225mA)
mA(p-p) / mA(RMS)	/ 160mA (Drive @24Vp-p, 1kHz)

FREQUENCY CHARACTERISTICS (Reference value)

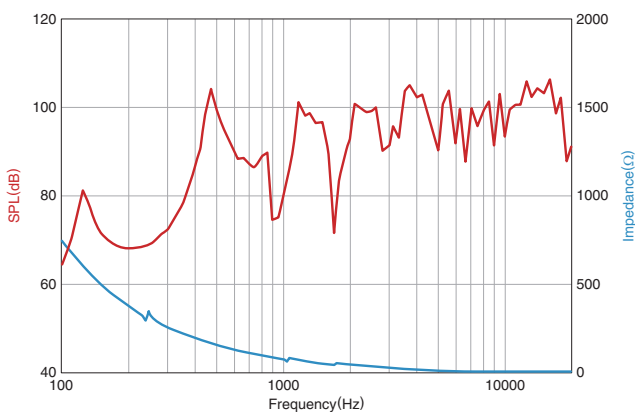

Measurement condition	
Input voltage	12Vp-p(±6V)
Distance	10cm to mic
Frequency	1000 to 20kHz
Fixed	Glass 220x220x0.7mm (* Refer to The following figure)

* Glass fixing

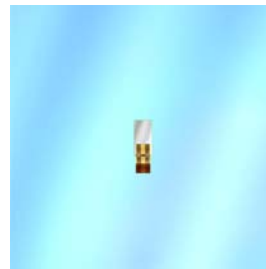

PHUA3015-049B-00-000

■ PACKAGING STYLE/PACKING NUMBER/MINIMUM ORDERING UNIT

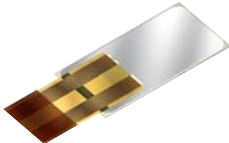
	PHUA3015-049B-00-000
	
Packaging style	Bulk (Tray)
Package quantity	300 pieces / corrugated cardboard (5 trays containing 60 pieces)
Minimum ordering unit	300 pieces (1 boxes of corrugated cardboard containing 300 piece)

□ Tray

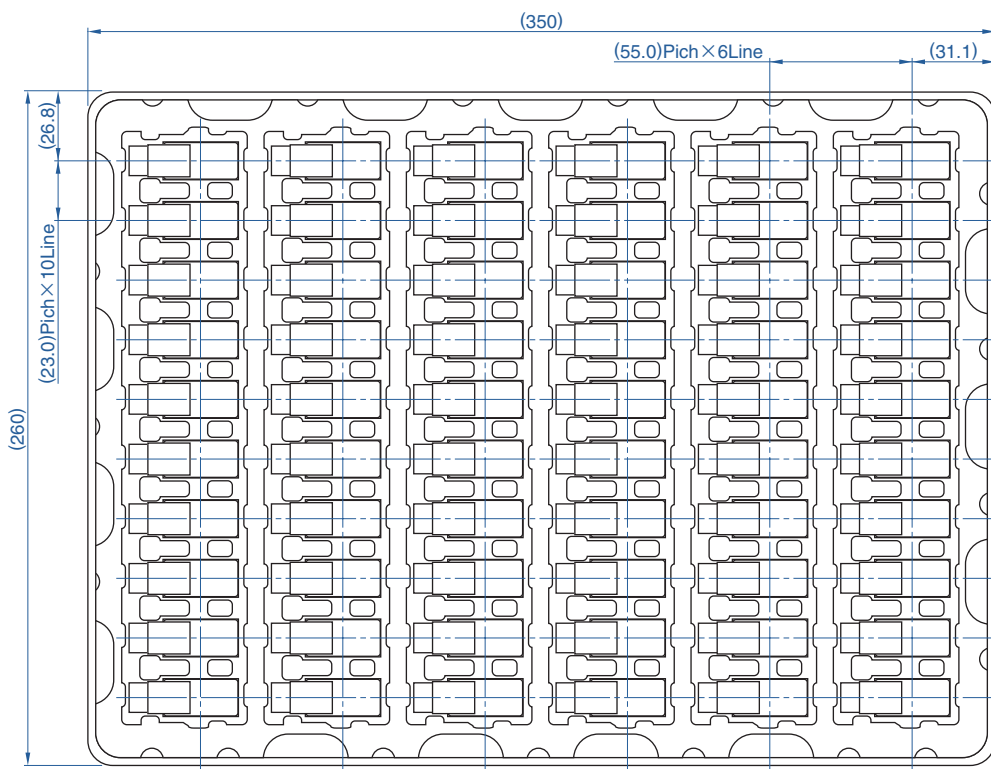

⚠ Please be sure to request delivery specifications that provide further details on the features and specifications of the products for proper and safe use.
Please note that the contents may change without any prior notice due to reasons such as upgrading.

PHUA2010-049B-00-000

SHAPE & DIMENSIONS

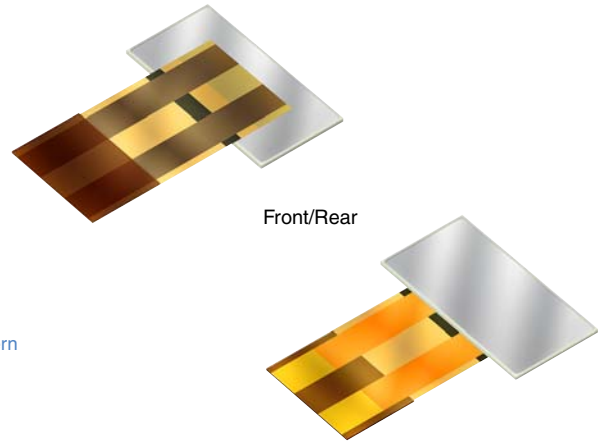
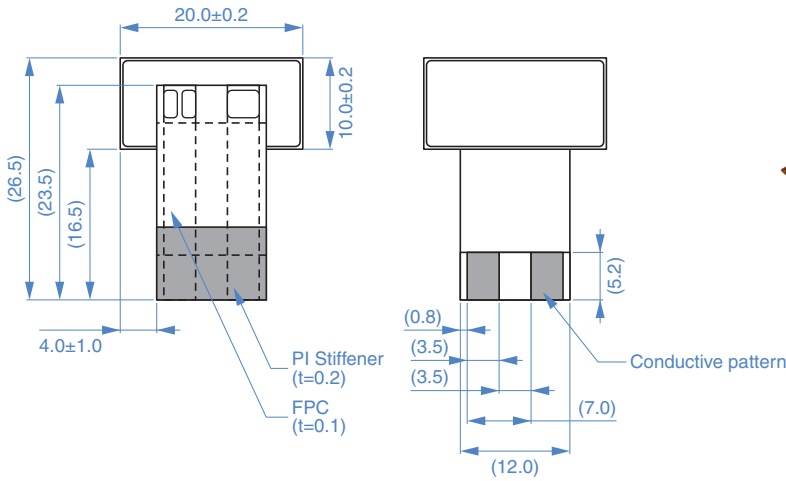

SPECIFICATIONS

Dimensions	Element	20x10x0.49 mm
Electrode		FPC (23.5x12x0.3 mm)
Operating voltage range(max.)		24Vp-p(±12V)max
Operating temperature range		-10 to 60°C

ELECTRICAL CHARACTERISTICS

Capacitance: C	(1.0uF±30%,1kHz,1V)
Current consumption:	200mA _{p-p} (±100mA)
mA(p-p) / mA(RMS)	/ 70mA (Drive @24Vp-p, 1kHz)

FREQUENCY CHARACTERISTICS (Reference value)

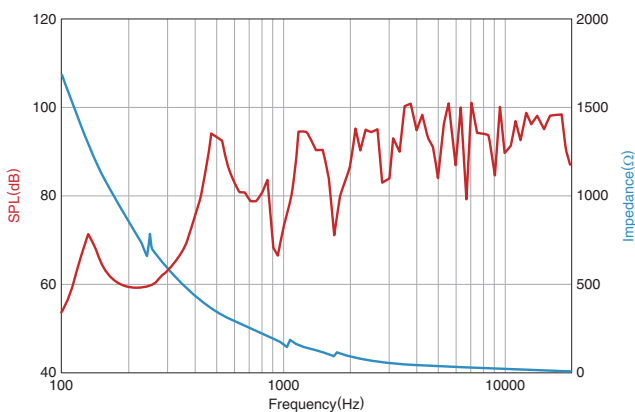

Measurement condition	
Input voltage	12Vp-p(±6V)
Distance	10cm to mic
Frequency	1000 to 20kHz
Fixed	Glass 220x220x0.7mm (* Refer to The following figure)

* Glass fixing

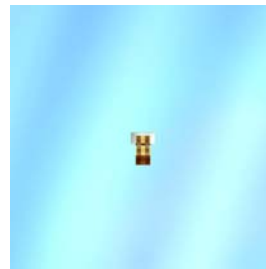

⚠ Please be sure to request delivery specifications that provide further details on the features and specifications of the products for proper and safe use. Please note that the contents may change without any prior notice due to reasons such as upgrading.

PHUA2010-049B-00-000

■ PACKAGING STYLE/PACKING NUMBER/MINIMUM ORDERING UNIT

	PHUA2010-049B-00-000
Packaging style	Bulk (Tray)
Package quantity	400 pieces / corrugated cardboard (5 trays containing 80 pieces)
Minimum ordering unit	400 pieces (1 boxes of corrugated cardboard containing 400 piece)

□ Tray

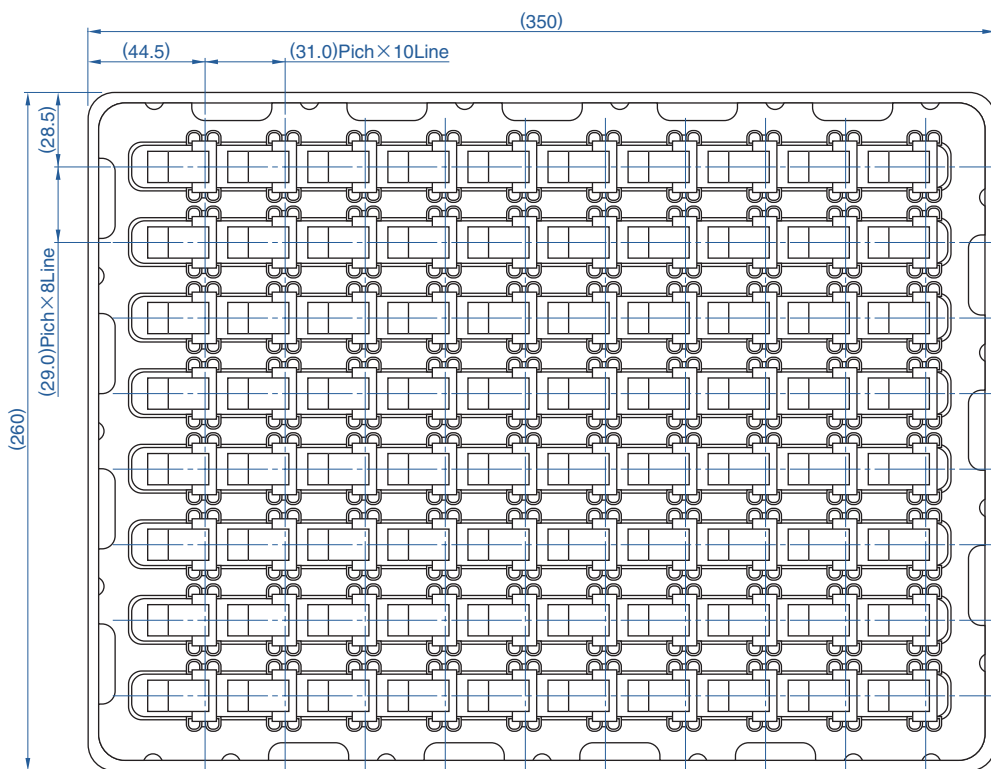

⚠ Please be sure to request delivery specifications that provide further details on the features and specifications of the products for proper and safe use.
Please note that the contents may change without any prior notice due to reasons such as upgrading.