

SUMMARY

Wires

Low voltage 10



Image is for illustrative purpose only

Series 1B
Termination type Male solder
IP rating 50
AWG wire size 34.00 - 28.00
Cable Ø 7.30 - 7.60 mm
Status active
Matching parts [EGG.1B.310.CLL](#)
[PHG.1B.310.CLLD76](#)

Download

[Request a quote](#)
[Eplan](#)
[Catalog](#)
[See video assembly instructions](#)

TECHNICAL DETAILS

Mechanics

Shell Style/Model FG*: Straight plug, cable collet
Keying 1 key (alpha=0, plug: male contacts, receptacle: female contacts)
Housing Material Brass (chrome plated [SAE AMS 2460]) shell and collet nut, nickel plated [SAE AMS QQ N 290] brass latch sleeve and mid pieces
Weight 15.35 g

Performance

Configuration 1B.310 : 10 Low Voltage
Insulator L: PEEK (UL 94 / V-0/1.5)
Rated Current 2.5 Amps

Specifications

Contact Type: Solder
Contact Dia.: 0.5 mm (0.02in)
Bucket Dia.: 0.45 mm (0.018in)
Max. Solid Conductor: 0.09 mm² (AWG 28)
Max. Stranded Conductor: 0.09 mm² (AWG 28)
R (max): 8.7 mOhm
Vtest (contact-shell): 1500 V (AC), 2120 V (DC)
Vtest (contact-contact): 900 V (AC), 1270 V (DC)

LEMO products and services are provided "as is". LEMO makes no warranties or representations with regard to LEMO product & services or use of them, express, implied or statutory, including for accuracy, completeness, or security. The user is fully responsible for his products and applications using LEMO components.

Others

Endurance (Shell): 5000
Temp (min / max): -55° C / +250° C
Humidity (max): <=95% [at 60 deg C / 140 F]
Vibration: 15 g [10 Hz - 2000 Hz]
Shock Resistance: 100 g [6 ms]
Climatical Category: 50/175/21
Shielding (min): 75 dB (10 MHz)
Shielding (min): 40 dB (1 GHz)
Salt Spray Corrosion: >1000 hr

DRAWINGS

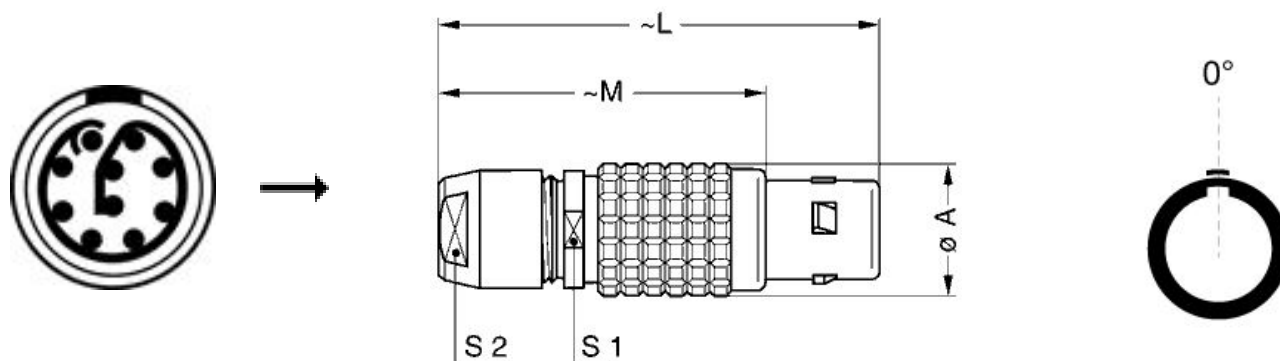

Dimensions

	A	L	M	S1	S2
mm.	12	43	32	10	9
in.	0,47	1,69	1,26	0,39	0,35

RECOMMENDED BY LEMO

Tools

Spanner wrench: [DCD.1B.ZZZ.PA090](#)

Caps: [BFG.1B.100.PCSG](#)

LEMO products and services are provided "as is". LEMO makes no warranties or representations with regard to LEMO product & services or use of them, express, implied or statutory, including for accuracy, completeness, or security. The user is fully responsible for his products and applications using LEMO components.

LEMO products and services are provided "as is". LEMO makes no warranties or representations with regard to LEMO product & services or use of them, express, implied or statutory, including for accuracy, completeness, or security. The user is fully responsible for his products and applications using LEMO components.