



WTB4-3P2271

W4-3

MINIATURE PHOTOELECTRIC SENSORS

SICK
Sensor Intelligence.



Illustration may differ



Ordering information

Type	Part no.
WTB4-3P2271	1042190

Other models and accessories → www.sick.com/W4-3

Detailed technical data

Features

Functional principle	Photoelectric proximity sensor
Functional principle detail	Background suppression
Dimensions (W x H x D)	16 mm x 39.5 mm x 12 mm
Housing design (light emission)	Rectangular
Sensing range max.	4 mm ... 150 mm ¹⁾
Sensing range	15 mm ... 150 mm ¹⁾
Type of light	Visible red light
Light source	PinPoint LED ²⁾
Light spot size (distance)	5 mm x 28 mm (50 mm)
Wave length	650 nm
Adjustment	Potentiometer, 5 turns
Special applications	Detecting perforated objects, Detecting objects with position tolerances, Detecting small objects

¹⁾ Object with 90% remission (based on standard white, DIN 5033).

²⁾ Average service life: 100,000 h at T_J = +25 °C.

Mechanics/electronics

Supply voltage	10 V DC ... 30 V DC ¹⁾
Ripple	< 5 V _{pp} ²⁾
Current consumption	20 mA ³⁾
Switching output	PNP
Output function	Complementary
Switching mode	Light/dark switching
Output current I_{max}	≤ 100 mA
Response time	< 0.5 ms ⁴⁾
Switching frequency	1,000 Hz ⁵⁾
Connection type	Male connector M8, 4-pin
Circuit protection	A ⁶⁾ C ⁷⁾ D ⁸⁾
Protection class	III
Weight	30 g
Housing material	Plastic, ABS
Optics material	Plastic, PMMA
Enclosure rating	IP67 IP66
Special feature	Line-shaped light spot
Ambient operating temperature	-40 °C ... +60 °C
Ambient temperature, storage	-40 °C ... +75 °C
UL File No.	NRKH.E181493 & NRKH7.E181493

¹⁾ Limit values.

²⁾ May not exceed or fall below U_v tolerances.

³⁾ Without load.

⁴⁾ Signal transit time with resistive load.

⁵⁾ With light/dark ratio 1:1.

⁶⁾ A = V_S connections reverse-polarity protected.

⁷⁾ C = interference suppression.

⁸⁾ D = outputs overcurrent and short-circuit protected.

Safety-related parameters

MTTF_D	1,143 years
DC_{avg}	0 %

Classifications

eCl@ss 5.0	27270904
eCl@ss 5.1.4	27270904
eCl@ss 6.0	27270904
eCl@ss 6.2	27270904
eCl@ss 7.0	27270904
eCl@ss 8.0	27270904
eCl@ss 8.1	27270904

eCl@ss 9.0	27270904
eCl@ss 10.0	27270904
eCl@ss 11.0	27270904
eCl@ss 12.0	27270903
ETIM 5.0	EC002719
ETIM 6.0	EC002719
ETIM 7.0	EC002719
ETIM 8.0	EC002719
UNSPSC 16.0901	39121528

Connection type

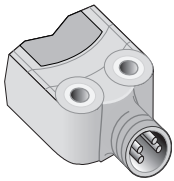

Connection diagram

Cd-083

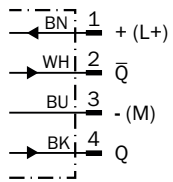

Light spot size

WTB4-3, line-shaped light spot

Lightspot: line width

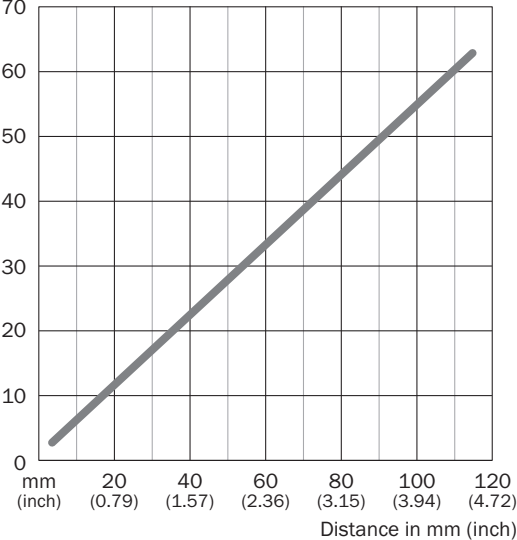

Sensing range diagram

WTB4-3, line-shaped light spot

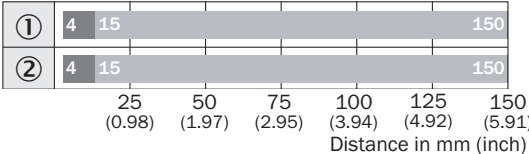

- Sensing range max.
- Sensing range
- ① Sensing range on white, 90% remission
- ② Sensing range on black, 6% remission

Dimensional drawing (Dimensions in mm (inch))

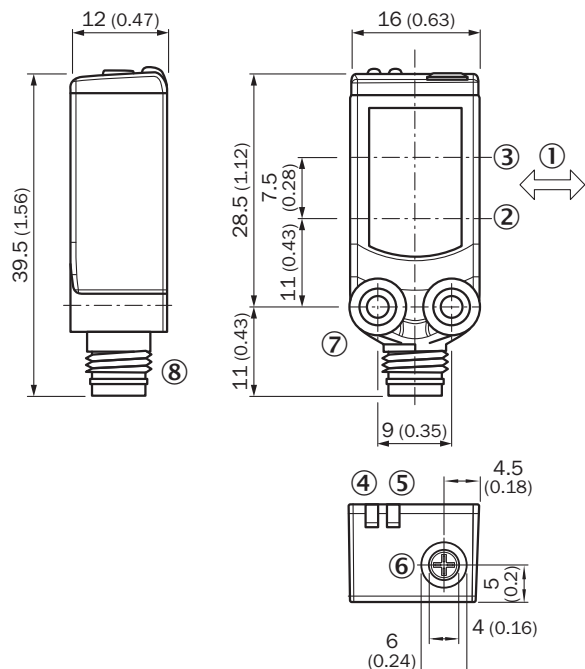

WTx4-3, potentiometer



- ① Standard direction of the material being detected
- ② Optical axis, sender
- ③ Optical axis, receiver
- ④ LED indicator yellow: Status of received light beam
- ⑤ LED indicator green: Supply voltage active
- ⑥ Potentiometer
- ⑦ Threaded mounting hole M3
- ⑧ Connection

Recommended accessories

Other models and accessories → www.sick.com/W4-3

	Brief description	Type	Part no.
Plug connectors and cables			
	Head A: female connector, M8, 4-pin, straight, A-coded Head B: Flying leads Cable: Sensor/actuator cable, PVC, unshielded, 5 m	YF8U14-050VA3XLEAX	2095889
	Head A: male connector, M8, 4-pin, straight Cable: unshielded	STE-0804-G	6037323

SICK AT A GLANCE

SICK is one of the leading manufacturers of intelligent sensors and sensor solutions for industrial applications. A unique range of products and services creates the perfect basis for controlling processes securely and efficiently, protecting individuals from accidents and preventing damage to the environment.

We have extensive experience in a wide range of industries and understand their processes and requirements. With intelligent sensors, we can deliver exactly what our customers need. In application centers in Europe, Asia and North America, system solutions are tested and optimized in accordance with customer specifications. All this makes us a reliable supplier and development partner.

Comprehensive services complete our offering: SICK LifeTime Services provide support throughout the machine life cycle and ensure safety and productivity.

For us, that is “Sensor Intelligence.”

WORLDWIDE PRESENCE:

Contacts and other locations –www.sick.com