

Click to
ORDER
samples

AM10CW-VZ



1 x 1

The new AM10CW-VZ is an ultra-wide input DC/DC converter that offers 4:1 input voltage range and dual isolated output channels also leading to improved reliability and performance. This series will offer many benefits to your system if it requires several voltage supply rails supplied by one component.

This series offers great operating temperatures, from -40°C to +85°C with full power up to 65°C. It also features an isolation of 1500VDC for improved reliability and system safety. Furthermore, a high MTBF of 1,000,000h, output short circuit protection (OSCP), output over-current protection (OCP), output over-voltage protection (OVP) and input under-voltage protection (UVLO) come standard with the series.

The AM10CW-VZ is great for distributed power supply systems, industrial controls, power grid, instruments and communications applications.

Features

- Operating Temp: -40 °C to +85 °C
- High isolation voltage: 1500VDC
- Low ripple & noise, 75mV (p-p), typ.
- Regulated Output
- 1" x 1" package
- Output short circuit, over-current, over-voltage, input under-voltage protection

Summary

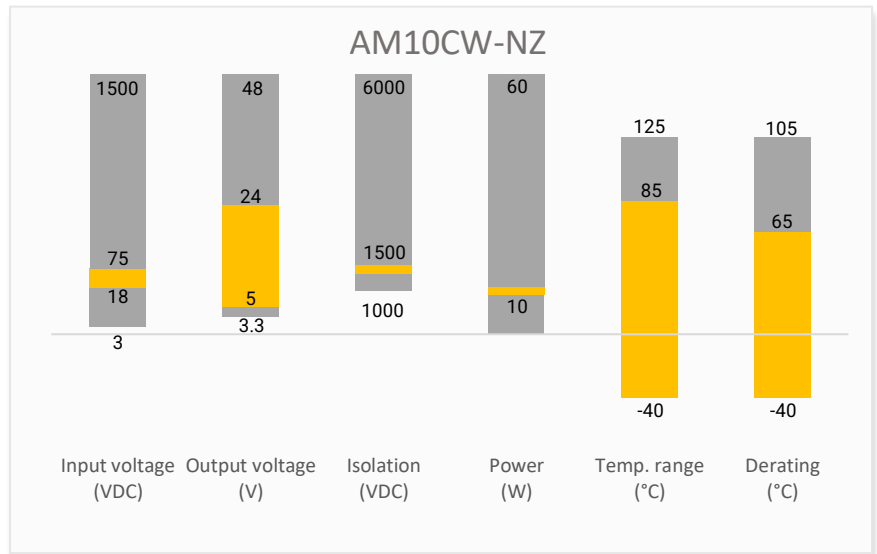

Training

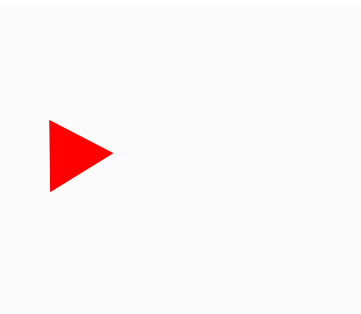

Product Training Video
(click to open)

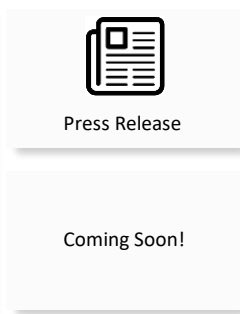

Application Notes

Applications



Power Grid



Industrial



Telecom



Instrumentation

Models & Specifications

Dual Output

Model	Input Voltage (VDC)	Output Voltage (VDC)		Input Current Max (mA)		Output Current Max (mA)		Maximum Capacitive Load (μF)		Efficiency (%) Full Load Typ.
		Vo1	Vo2	No Load	Full Load	Io1	Io2	Vo1	Vo2	
AM10CW-480505DVZ	48 (18-75)	5	5	10	258	1000	1000	1000	1000	84
AM10CW-480512DVZ	48 (18-75)	5	12	10	258	1000	417	1000	470	84
AM10CW-480524DVZ	48 (18-75)	5	24	10	258	1000	209	1000	100	84

Input Specification

Parameters	Conditions	Typical	Maximum	Units
Input voltage		18 - 75	80	VDC
Input reflected ripple current	Nominal input	30		mA
Absolute maximum rating	1s		100	VDC
Filter	Pi Filter			
Start-up voltage			18	VDC
Under-voltage Protection		15.5		VDC
On/Off control	ON - open or pulled high (3.5 - 12 VDC) OFF - pulled low to GND (0 - 1.2 VDC), idle current 10mA max.			

Isolation Specification

Parameters	Conditions	Typical	Maximum	Units
Tested isolation voltage	Input / output 60 sec, ≤ 1mA	1500		VDC
	Output 1 / output 2 60 sec, ≤ 1mA	500		
Resistance	500VDC	≥1000		MΩ
Capacitance	100kHz/ 0.1V	1000		pF

Output Specification

Parameters	Conditions	Typical	Maximum	Units	
Voltage accuracy	Output 1, 0% -100% load	±1	±3	%	
	Output 2, balanced load	±3	±6		
Line regulation	LL – HL 100% load	Output 1	±0.3	±0.5	%
		Output 2	±2	±3	
Load regulation	10% - 100% balanced load	Output 1	±0.5	±1	%
		Output 2	±3	±6	
Short circuit protection*	Continues, Auto recovery				
Over current protection	Balanced load	150	200	% Io	
Over voltage protection		≥110	160	% Vo	
Transient Recovery Time	Nominal input, Output 1 25% load step change	300	500	μs	
Transient Response Deviation	Nominal input, Output 1 25% load step change	±5	±8	%	
Ripple & Noise	20MHz bandwidth, 5%-100% load	75	150	mV pk-pk	

*Both outputs enter hiccup protection if short circuit presents on any of the outputs. When short circuit presents on output 2, output 1 loading must be within 10 - 100% in order to enter hiccup protection.

General Specifications				
Parameters	Conditions	Typical	Maximum	Units
Switching frequency*	100% Load	300		KHz
Operating temperature	With derating	-40 to +85		°C
Storage temperature		-55 to +125		°C
Soldering temperature	1.5mm distance ≤ 10s		300	°C
Temperature coefficient	100% Load		± 0.03	%/°C
Cooling	Free air convection			
Humidity	Non-condensing		95	% RH
Base material	Aluminum alloy			
Weight		13.0		g
Dimensions (L x W x H)	1.00 x 1.00 x 0.46 inches (25.40 x 25.40 x 11.70 mm)			
Vibration	10 – 150Hz, 5G, along all axels			
MTBF	> 1 000 000 hrs (MIL-HDBK -217F, t=+25°C)			

*Switching frequency reduces when load under 50%.
NOTE: All specifications in this datasheet are measured at an ambient temperature of 25°C, humidity<75%, nominal input voltage and at rated output load unless otherwise specified.

Safety Specifications		
Parameters		
Standards	Design to meet EN62368	
	EMI - Conducted and radiated emission	CISPR32/EN55032 Class B with recommended EMC circuit B
	Electrostatic Discharge Immunity	IEC/EN 61000-4-2, Contact ±4KV, Air ±6KV, Criteria B
	RF, Electromagnetic Field Immunity	IEC/EN 61000-4-3, 10V/m, Criteria A
	Electrical Fast Transient/Burst Immunity	IEC/EN 61000-4-4, ±2KV with recommended EMC circuit A, Criteria B
	Surge Immunity	IEC/EN 61000-4-5, L-L ±2KV with recommended EMC circuit A, Criteria B
	RF, Conducted Disturbance Immunity	IEC/EN 61000-4-6, 10Vr.m.s, Criteria A

Derating

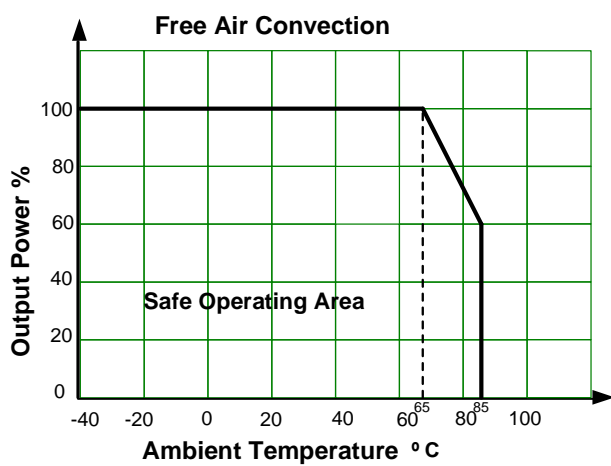

Typical Application Circuit

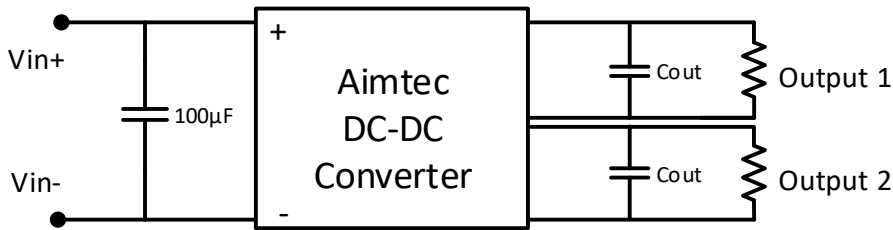

Output voltage	Cout
5 VDC	100 µF
12 / 24 VDC	22 µF

EMI Application Circuit

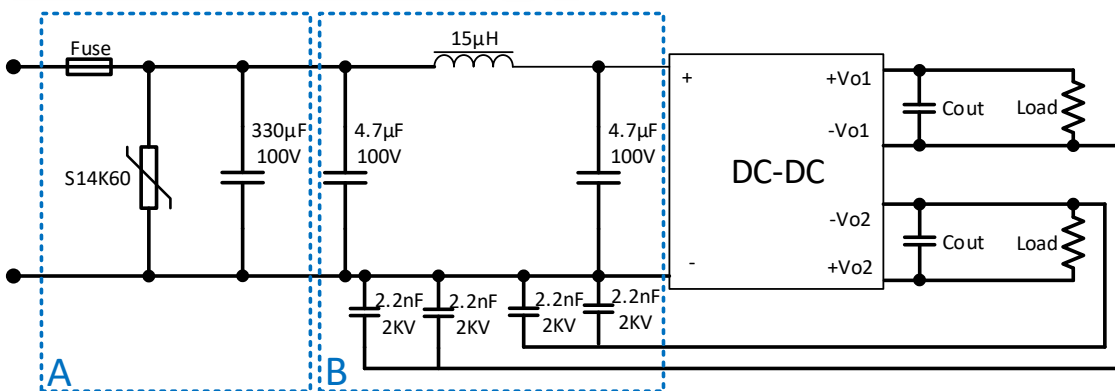

Part A for EFT immunity IEC/EN 61000-4-4 and surge immunity IEC/EN 61000-4-5 compliance.
Part B for EMI CISPR32/EN55032 compliance.

Dimensions

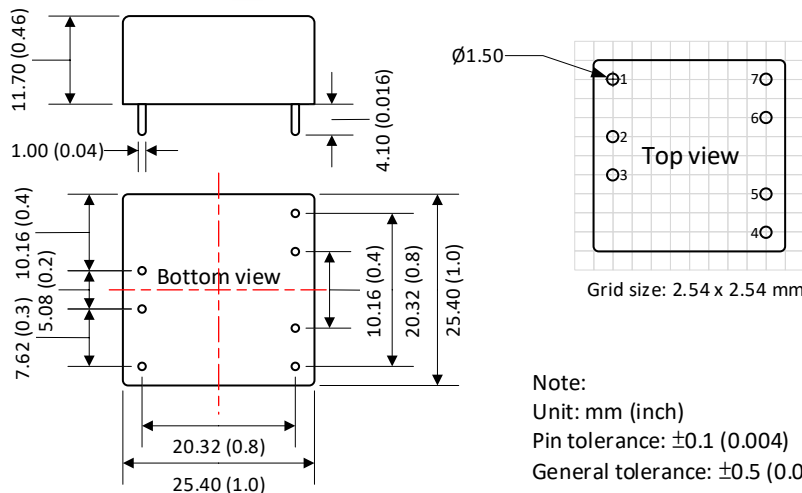

Pin Out Specifications

Pin	Single
1	Ctrl
2	-V Input
3	+V Input
4	+V Output 2
5	-V Output 2
6	-V Output 1
7	+V Output 1

NOTE: 1. Datasheets are updated as needed and as such, specifications are subject to change without notice. Once printed or downloaded, datasheets are no longer controlled by Aimtec; refer to www.aimtec.com for the most current product specifications. 2. Product labels shown, including safety agency certifications on labels, may vary based on the date manufactured. 3. Mechanical drawings and specifications are for reference only. 4. All specifications are measured at an ambient temperature of 25°C, humidity < 75%, nominal input voltage and at rated output load unless otherwise specified. 5. Aimtec may not have conducted destructive testing or chemical analysis on all internal components and chemicals at the time of publishing this document. CAS numbers and other limited information are considered proprietary and may not be available for release. 6. This product is not designed for use in critical life support systems, equipment used in hazardous environments, nuclear control systems or other such applications which necessitate specific safety and regulatory standards other than the ones listed in this datasheet. 7. Warranty is in accordance with Aimtec's standard Terms of Sale available at www.aimtec.com.