

OPA375, OPA2375, OPA4375 500- μ V (Maximum), 10-MHz, Low Broadband Noise, RRO, Operational Amplifier

1 Features

- Low broadband noise: 3.5 nV/ $\sqrt{\text{Hz}}$
- Low offset voltage: 500 μ V (maximum)
- Low THD+N: 0.00015%
- Gain bandwidth: 10 MHz
- Rail-to-rail output
- Unity-gain stable
- Low I_Q :
 - OPA375: 890 μ A/ch
 - OPA2375/OPA4375: 990 μ A/ch
- Wide supply range:
 - OPA375: 2.25 V to 5.5 V
 - OPA2375/OPA4375: 1.7 V to 5.5 V
- Low offset voltage drift: ± 0.16 μ V/ $^{\circ}$ C

2 Applications

- [Photodiode amplifiers](#)
- [Precision sensor front-ends](#)
- [ADC input-driver amplifiers](#)
- [Test and measurement equipment](#)
- [Sensor field transmitters](#)
- [Wearable consumer applications](#)
- [Audio equipment](#)
- [Medical instrumentation](#)
- [Active filters](#)

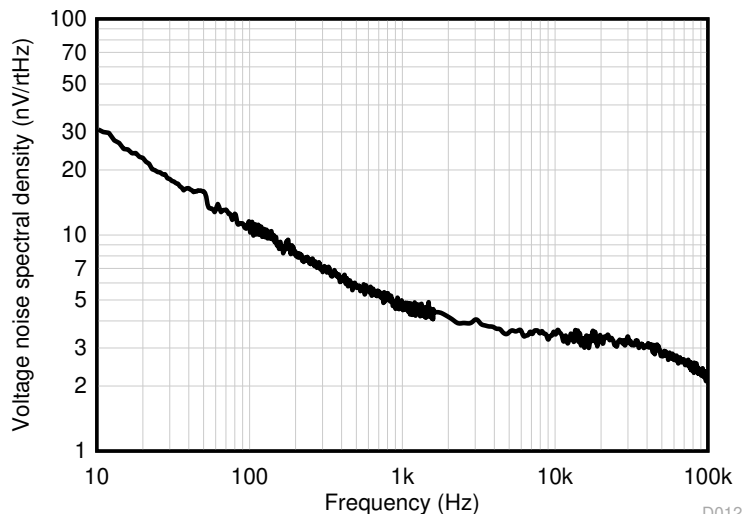

Noise Spectral Density vs Frequency

3 Description

The OPAx375 family includes single (OPA375), dual (OPA2375) and quad-channel (OPA4375) general-purpose CMOS operation amplifiers (op amp) that provide an extremely low noise figure of 3.5 nV/ $\sqrt{\text{Hz}}$, a low offset of 500 μ V (maximum) and a wide bandwidth of 10 MHz. The low noise and wide bandwidth make the OPAx375 family attractive for a variety of precision applications that require a good balance between cost and performance. Additionally, the input bias current of the OPAx375 supports applications with high source impedance.

The robust design of the OPAx375 family provides ease-of-use to the circuit designer due to the unity-gain stability, integrated RFI/EMI rejection filter, no phase reversal in overdrive conditions, and high electrostatic discharge (ESD) protection (2-kV HBM). Additionally, the resistive open-loop output impedance allows for easy stabilization with much higher capacitive loads.

This op amp is optimized for low-voltage operation as low as 2.25 V (± 1.125 V) for the OPA375 and 1.7 V (± 0.85 V) for the OPA2375 and OPA4375. All of the devices operate up to 5.5 V (± 2.75 V), and are specified over the temperature range of -40°C to 125°C .

The single-channel OPA375 is available in a small-size SC70-5 package. The dual-channel OPA2375 is available in multiple package options including a tiny 1.5 mm \times 2.0 mm X2QFN package.

Device Information

PART NUMBER ⁽¹⁾	PACKAGE	BODY SIZE (NOM)
OPA375	SC70 (5)	1.25 mm \times 2.00 mm
OPA2375	SOIC (8)	3.91 mm \times 4.90 mm
	TSSOP (8)	3.00 mm \times 4.40 mm
	VSSOP (8)	3.00 mm \times 3.00 mm
	SOT-23 (8)	1.60 mm \times 2.90 mm
	WSON (8)	2.00 mm \times 2.00 mm
	X2QFN (10)	1.50 mm \times 2.00 mm

- (1) For all available packages, see the orderable addendum at the end of the data sheet.



Table of Contents

1 Features	1	8.4 Device Functional Modes.....	31
2 Applications	1	9 Application and Implementation	32
3 Description	1	9.1 Application Information.....	32
4 Revision History	2	9.2 Single-Supply Electret Microphone Preamplifier With Speech Filter.....	32
5 Device Comparison Table	4	10 Power Supply Recommendations	35
6 Pin Configuration and Functions	5	11 Layout	36
7 Specifications	7	11.1 Layout Guidelines.....	36
7.1 Absolute Maximum Ratings	7	11.2 Layout Example.....	37
7.2 ESD Ratings	7	12 Device and Documentation Support	39
7.3 Recommended Operating Conditions	7	12.1 Documentation Support.....	39
7.4 Thermal Information for Single Channel	7	12.2 Receiving Notification of Documentation Updates.....	39
7.5 Thermal Information for Dual Channel	8	12.3 Support Resources.....	39
7.6 Electrical Characteristics	9	12.4 Trademarks.....	39
7.7 Typical Characteristics: OPA375.....	12	12.5 Electrostatic Discharge Caution.....	39
7.8 Typical Characteristics: OPA2375.....	19	12.6 Glossary.....	39
8 Detailed Description	26	13 Mechanical, Packaging, and Orderable Information	40
8.1 Overview.....	26		
8.2 Functional Block Diagram.....	26		
8.3 Feature Description.....	26		

4 Revision History

NOTE: Page numbers for previous revisions may differ from page numbers in the current version.

Changes from Revision D (February 2021) to Revision E (August 2021) Page

• Changed OPA2375 VSSOP (DGK) package from <i>Preview</i> to <i>Active</i>	1
• Removed preview tag for the VSSOP (DGK) package in the <i>Device Comparison Table</i> section.....	4
• Added VSSOP Package thermal data for OPA2375 in the <i>Thermal Information for Dual Channel</i> section.....	7

Changes from Revision C (June 2020) to Revision D (February 2021) Page

• Updated the numbering format for tables, figures, and cross-references throughout the document.....	1
• Changed Operating temperature from 125 to 150 in <i>Absolute Maximum Ratings</i>	7
• Added Junction temperature spec to <i>Absolute Maximum Ratings</i>	7
• Removed OPA375 Table of Graphs and OPA2375 Table of Graphs tables from the <i>Specifications</i> section....	12
• Removed <i>Related Links</i> section from the <i>Device and Documentation Support</i> section.....	39

Changes from Revision B (January 2020) to Revision C (June 2020) Page

• Changed OPA2375S X2QFN (RUG) package from <i>Preview</i> to <i>Active</i>	1
• Added X2QFN Package Drawing and Pin Functions for OPA2375S in <i>Pin Configuration and Functions</i> section.....	5
• Changed typical input current noise density value from 2 fA $\sqrt{\text{Hz}}$ to 23 fA $\sqrt{\text{Hz}}$	9
• Changed total supply voltage total from 5V to 5.5V in <i>Electrical Characteristics</i> condition statement.....	9
• Deleted "Vs = 2.25 V to 5.5 V" test conditions for common-mode rejection ratio parameter in <i>Electrical Characteristics</i>	9

Changes from Revision A (January 2019) to Revision B (January 2020) Page

• Changed Low Broadband Noise specification in <i>Features</i> section to match OPA2375 specification	1
• Added THD+N specification to <i>Features</i> section.....	1
• Added I _Q definition for OPA2375 and OPA4375 in <i>Features</i> section.....	1
• Added supply range definition for OPA2375 and OPA4375 in <i>Features</i> section.....	1
• Changed Noise Spectral Density vs Frequency plot on front page to the OPA2375 noise plot.....	1

• Changed wording in <i>Description</i> section to reflect the whole OPAx375 family.....	1
• Added OPA2375 devices to <i>Device Information</i> table.....	1
• Added <i>Device Comparison Table</i> section.....	4
• Added pin out drawings for OPA2375 packages in <i>Pin Configuration and Functions</i> section.....	5
• Added pin functions for OPA2375 packages.....	5
• Changed Human-body model (HBM) value from: ± 1000 to ± 3000 and Charged-device mode (CDM) value from ± 250 to ± 1000	7
• Added OPA2375 typical characteristic graphs in the <i>Specifications</i> section.....	12
• Added <i>EMI Rejection</i> section with description information to <i>Detailed Description</i> section.....	27
• Added <i>Electrical Overstress</i> section and diagram to <i>Detailed Description</i> section.....	28
• Added <i>Typical Specification and Distributions</i> section to <i>Detailed Description</i> section.....	29
• Added <i>Shutdown Function</i> section with description for OPAx375S to <i>Detailed Description</i> section.....	30
• Added <i>Packages With an Exposed Thermal Pad</i> section to <i>Detailed Description</i> section.....	30
• Added dual channel layout example in the <i>Layout</i> section.....	37

Changes from Revision * (November 2017) to Revision A (January 2019)	Page
---	-------------

• Added maximum input offset voltage drift specification in <i>Electrical Characteristics</i>	9
---	---

5 Device Comparison Table

DEVICE	NO. OF CHANNELS	PACKAGE LEADS						
		SOIC D	SC-70 DCK	VSSOP DGK	WSON DSG	TSSOP PW	SOT-23 DDF	X2QFN RUG
OPA375	1	—	5	—	—	—	—	—
OPA2375	2	8	—	8	8	8	8	—
		—	—	—	—	—	—	10

6 Pin Configuration and Functions

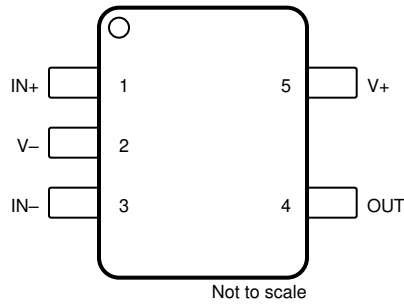

**Figure 6-1. OPA375 DCK Package
5-Pin SC70
Top View**

Table 6-1. Pin Functions: OPA375

PIN		I/O	DESCRIPTION
NAME	NO.		
+IN	1	I	Noninverting input
-IN	3	I	Inverting input
OUT	4	O	Output
V+	5	—	Positive (highest) supply
V-	2	—	Negative (lowest) supply or ground (for single-supply operation)

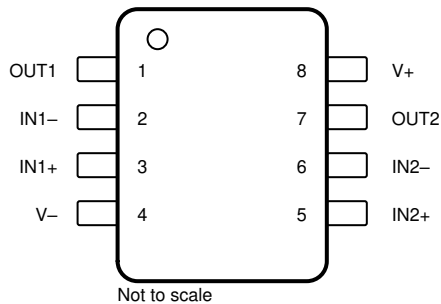

**Figure 6-2. OPA2375 D, DGK, PW, and DDF
Package
8-Pin SOIC, VSSOP, TSSOP, and SOT-23
Top View**

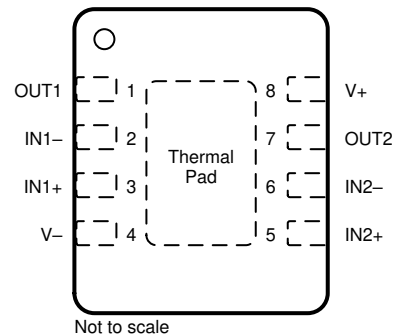

Connect thermal pad to V-. See [Section 8.3.8](#) for more information.

**Figure 6-3. OPA2375 DSG Package
8-Pin WSON With Exposed Thermal Pad
Top View**

Table 6-2. Pin Functions: OPA2375

PIN		I/O	DESCRIPTION
NAME	NO.		
IN1-	2	I	Inverting input, channel 1
IN1+	3	I	Noninverting input, channel 1
IN2-	6	I	Inverting input, channel 2
IN2+	5	I	Noninverting input, channel 2
OUT1	1	O	Output, channel 1
OUT2	7	O	Output, channel 2

Table 6-2. Pin Functions: OPA2375 (continued)

PIN		I/O	DESCRIPTION
NAME	NO.		
V-	4	—	Negative (lowest) supply or ground (for single-supply operation)
V+	8	—	Positive (highest) supply

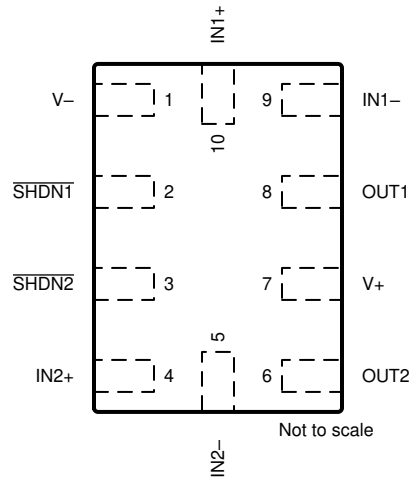

**Figure 6-4. OPA2375S RUG Package
10-Pin X2QFN
Top View**

Table 6-3. Pin Functions: OPA2375S

PIN		I/O	DESCRIPTION
NAME	NO.		
IN1-	9	I	Inverting input, channel 1
IN1+	10	I	Noninverting input, channel 1
IN2-	5	I	Inverting input, channel 2
IN2+	4	I	Noninverting input, channel 2
OUT1	8	O	Output, channel 1
OUT2	6	O	Output, channel 2
SHDN1	2	I	Shutdown: low = amp disabled, high = amp enabled. Channel 1. See Section 8.3.7 for more information.
SHDN2	3	I	Shutdown: low = amp disabled, high = amp enabled. Channel 2. See Section 8.3.7 for more information.
V-	1	I or —	Negative (lowest) supply or ground (for single-supply operation)
V+	7	I	Positive (highest) supply

7 Specifications

7.1 Absolute Maximum Ratings

over operating ambient temperature range (unless otherwise noted) ⁽¹⁾

		MIN	MAX	UNIT
Supply voltage, $V_S = (V+) - (V-)$		0	6	V
Signal input pins	Common-mode voltage ^{(3) (4)}	$(V-) - 0.5$	$(V+) + 0.5$	V
	Differential voltage ⁽³⁾		$V_S + 0.2$	V
	Current ⁽³⁾	-10	10	mA
Output short-circuit ⁽²⁾		Continuous		
Operating ambient temperature, T_A		-55	150	°C
Junction temperature, T_J			150	°C
Storage temperature, T_{stg}		-65	150	°C

- (1) Operating the device beyond the ratings listed under *Absolute Maximum Ratings* will cause permanent damage to the device. These are stress ratings only, based on process and design limitations, and this device has not been designed to function outside the conditions indicated under *Recommended Operating Conditions*. Exposure to any condition outside *Recommended Operating Conditions* for extended periods, including absolute-maximum-rated conditions, may affect device reliability and performance.
- (2) Short-circuit to ground, one amplifier per package.
- (3) Input pins are diode-clamped to the power-supply rails. Input signals that may swing more than 0.5 V beyond the supply rails must be current limited to 10 mA or less.
- (4) Differential input voltages greater than 0.25 V applied continuously can result in a shift to the input offset voltage above the maximum specification of this parameter. The magnitude of this effect increases as the ambient operating temperature rises.

7.2 ESD Ratings

			VALUE	UNIT
$V_{(ESD)}$	Electrostatic discharge	OPA375: Human-body model (HBM), per ANSI/ESDA/JEDEC JS-001 ⁽¹⁾	±3000	V
		OPA2375: Human-body model (HBM), per ANSI/ESDA/JEDEC JS-001 ⁽¹⁾	±2000	
		All Devices: Charged-device model (CDM), per JEDEC specification JESD22-C101 ⁽²⁾	±1500	

- (1) JEDEC document JEP155 states that 500-V HBM allows safe manufacturing with a standard ESD control process.
- (2) JEDEC document JEP157 states that 250-V CDM allows safe manufacturing with a standard ESD control process.

7.3 Recommended Operating Conditions

over operating ambient temperature range (unless otherwise noted)

		MIN	MAX	UNIT
V_S	Supply voltage, $(V+) - (V-)$, for OPA2375 and OPA4375	1.7 ⁽¹⁾	5.5	V
V_S	Supply voltage, $(V+) - (V-)$, for OPA375 only	2.25	5.5	V
V_I	Input voltage range	$(V-)$	$(V+) - 1.2$	V
T_A	Specified temperature	-40	125	°C

- (1) Operation between 1.7 V and 1.8 V is only recommended for $T_A = 0 - 85^\circ\text{C}$

7.4 Thermal Information for Single Channel

THERMAL METRIC ⁽¹⁾		OPA375	UNIT
		DCK (SC70)	
		5 PINS	
$R_{\theta JA}$	Junction-to-ambient thermal resistance	240.9	°C/W
$R_{\theta JC(top)}$	Junction-to-case (top) thermal resistance	151.7	°C/W
$R_{\theta JB}$	Junction-to-board thermal resistance	64	°C/W
Ψ_{JT}	Junction-to-top characterization parameter	34.8	°C/W
Ψ_{JB}	Junction-to-board characterization parameter	63.3	°C/W

7.4 Thermal Information for Single Channel (continued)

THERMAL METRIC ⁽¹⁾		OPA375	UNIT
		DCK (SC70)	
		5 PINS	
R _{θJC(bot)}	Junction-to-case (bottom) thermal resistance	n/a	°C/W

(1) For more information about traditional and new thermal metrics, see the *Semiconductor and IC Package Thermal Metrics* application report [SPRA953C](#).

7.5 Thermal Information for Dual Channel

THERMAL METRIC ⁽¹⁾		OPA2375, OPA2375S						UNIT
		D (SOIC)	DDF (SOT-23-8)	DSG (WSON)	PW (TSSOP)	DGK (VSSOP)	RUG (X2QFN)	
		8 PINS	8 PINS	8 PINS	8 PINS	8 PINS	10 PINS	
R _{θJA}	Junction-to-ambient thermal resistance	131.1	153.8	78.2	185.6	177.0	140.3	°C/W
R _{θJC(top)}	Junction-to-case (top) thermal resistance	73.2	80.2	97.5	74.5	68.6	52.6	°C/W
R _{θJB}	Junction-to-board thermal resistance	74.5	73.1	44.6	116.3	98.7	69.7	°C/W
ψ _{JT}	Junction-to-top characterization parameter	24.4	6.6	4.7	12.6	12.4	1.0	°C/W
ψ _{JB}	Junction-to-board characterization parameter	73.3	72.7	44.6	114.6	97.1	67.5	°C/W
R _{θJC(bot)}	Junction-to-case (bottom) thermal resistance	n/a	n/a	19.8	n/a	n/a	n/a	°C/W

(1) For more information about traditional and new thermal metrics, see the *Semiconductor and IC Package Thermal Metrics* application report, [SPRA953C](#).

7.6 Electrical Characteristics

OPA2375/4375 Specifications: $V_S = (V+) - (V-) = 1.8\text{ V to }5.5\text{ V}$ ($\pm 0.9\text{ V to } \pm 2.75\text{ V}$) at $T_A = 25^\circ\text{C}$, $R_L = 10\text{ k}\Omega$ connected to $V_S / 2$, $V_{CM} = V_S / 2$, and $V_{OUT} = V_S / 2$, unless otherwise noted.

OPA375 Specifications: $V_S = (V+) - (V-) = 5.5\text{ V}$ at $T_A = 25^\circ\text{C}$, $R_L = 10\text{ k}\Omega$ connected to $V_S / 2$, $V_{CM} = V_S / 2$, and $V_{OUT} = V_S / 2$, unless otherwise noted.

PARAMETER		TEST CONDITIONS		MIN	TYP	MAX	UNIT
OFFSET VOLTAGE							
V_{OS}	Input offset voltage	$V_S = 5.0\text{ V}$			± 0.15	± 0.5	mV
			$T_A = -40^\circ\text{C to }125^\circ\text{C}$	OPA2/4375 ⁽³⁾		± 0.7	
dV_{OS}/dT	Input offset voltage drift		$T_A = -40^\circ\text{C to }125^\circ\text{C}$	OPA375 ⁽²⁾	± 0.35	± 2 ⁽⁴⁾	$\mu\text{V}/^\circ\text{C}$
				OPA2/4375 ⁽³⁾	± 0.16		
PSRR	Input offset voltage versus power supply	$V_S = 2.25\text{ V to }5.5\text{ V}$, $V_{CM} = V-$		OPA375 ⁽²⁾	± 0.32	± 6.3	$\mu\text{V}/\text{V}$
		$V_{VCM} = V-$		OPA2/4375 ⁽³⁾	± 0.7	± 5.8	
	Channel separation	$f = 20\text{ kHz}$			130		dB
INPUT BIAS CURRENT							
I_B	Input bias current			OPA375 ⁽²⁾	± 10		pA
				OPA2/4375 ⁽³⁾	± 3		
I_{OS}	Input offset current			OPA375 ⁽²⁾	± 10		pA
				OPA2/4375 ⁽³⁾	± 0.5		
NOISE							
E_N	Input voltage noise	$f = 0.1\text{ to }10\text{ Hz}$			1.2		μV_{PP}
					0.227		μV_{RMS}
e_N	Input voltage noise density	$f = 10\text{ Hz}$		OPA2/4375 ⁽³⁾	30		$\text{nV}/\sqrt{\text{Hz}}$
				OPA375 ⁽²⁾	5.0		
				OPA2/4375 ⁽³⁾	4.6		
				OPA375 ⁽²⁾	3.7		
i_N	Input current noise	$f = 1\text{ kHz}$		OPA2/4375 ⁽³⁾	3.5		$\text{fA}/\sqrt{\text{Hz}}$
				OPA375 ⁽²⁾	23		
INPUT VOLTAGE RANGE							
V_{CM}	Common-mode voltage range			(V-)	(V+) - 1.2		V
CMRR	Common-mode rejection ratio	$(V-) < V_{CM} < (V+) - 1.2\text{ V}$		OPA375 ⁽²⁾	95	120	dB
		$V_S = 1.8\text{ V}$, $(V-) < V_{CM} < (V+) - 1.2\text{ V}$		OPA2/4375 ⁽³⁾	87	100	
		$V_S = 5.5\text{ V}$, $(V-) < V_{CM} < (V+) - 1.2\text{ V}$		OPA2/4375 ⁽³⁾	94	110	
INPUT CAPACITANCE							
Z_{ID}	Differential				10 6		M Ω pF
Z_{ICM}	Common-mode				10 6		G Ω pF
OPEN-LOOP GAIN							
A_{OL}	Open-loop voltage gain	$(V-) + 40\text{ mV} < V_O < (V+) - 40\text{ mV}$, $R_L = 10\text{ k}\Omega$ to $V_S/2$		OPA375 ⁽²⁾	125		dB
		$(V-) + 150\text{ mV} < V_O < (V+) - 150\text{ mV}$, $R_L = 2\text{ k}\Omega$ to $V_S/2$			110	130	
		$V_S = 1.8\text{ V}$, $(V-) + 150\text{ mV} < V_O < (V+) - 150\text{ mV}$, $R_L = 2\text{ k}\Omega$ to $V_S/2$		OPA2/4375 ⁽³⁾	107	130	
		$V_S = 5.5\text{ V}$, $(V-) + 150\text{ mV} < V_O < (V+) - 150\text{ mV}$, $R_L = 2\text{ k}\Omega$ to $V_S/2$			140		
		$V_S = 1.8\text{ V}$, $(V-) + 40\text{ mV} < V_O < (V+) - 40\text{ mV}$, $R_L = 10\text{ k}\Omega$ to $V_S/2$			110	132	
		$V_S = 5.5\text{ V}$, $(V-) + 40\text{ mV} < V_O < (V+) - 40\text{ mV}$, $R_L = 10\text{ k}\Omega$ to $V_S/2$			142		

OPA375, OPA2375

SBOS886E – NOVEMBER 2017 – REVISED AUGUST 2021

OPA2375/4375 Specifications: $V_S = (V+) - (V-) = 1.8\text{ V to }5.5\text{ V}$ ($\pm 0.9\text{ V to } \pm 2.75\text{ V}$) at $T_A = 25^\circ\text{C}$, $R_L = 10\text{ k}\Omega$ connected to $V_S / 2$, $V_{CM} = V_S / 2$, and $V_{OUT} = V_S / 2$, unless otherwise noted.

OPA375 Specifications: $V_S = (V+) - (V-) = 5.5\text{ V}$ at $T_A = 25^\circ\text{C}$, $R_L = 10\text{ k}\Omega$ connected to $V_S / 2$, $V_{CM} = V_S / 2$, and $V_{OUT} = V_S / 2$, unless otherwise noted.

PARAMETER		TEST CONDITIONS		MIN	TYP	MAX	UNIT	
FREQUENCY RESPONSE								
GBW	Gain-bandwidth product				10		MHz	
SR	Slew rate	$V_S = 5.5\text{ V}$, $G = +1$, $C_L = 20\text{ pF}$			4.6		V/ μs	
t_s	Settling time	To 0.1%, $V_S = 5.5\text{ V}$, $V_{STEP} = 2\text{ V}$, $G = +1$, $C_L = 20\text{ pF}$			0.65		μs	
		To 0.01%, $V_S = 5.5\text{ V}$, $V_{STEP} = 2\text{ V}$, $G = +1$, $C_L = 20\text{ pF}$			1.2			
	Phase margin	$G = +1$, $R_L = 10\text{ k}\Omega$, $C_L = 20\text{ pF}$			55		$^\circ$	
	Overload recovery time	$V_{IN} \times \text{gain} > V_S$			0.2		μs	
THD+N	Total harmonic distortion + noise	$V_S = 5.5\text{ V}$, $V_{CM} = 2.5\text{ V}$, $V_O = 1\text{ V}_{RMS}$, $G = +1$, $f = 1\text{ kHz}$, $R_L = 10\text{ k}\Omega$		OPA375 ⁽²⁾	0.00035		%	
				OPA2/4375 ⁽³⁾	0.00015			
EMIRR	Electro-magnetic interference rejection ratio	$f = 1\text{ GHz}$		OPA2/4375 ⁽³⁾	51		dB	
OUTPUT								
	Voltage output swing from rail	Positive/Negative rail headroom	$V_S = 5.5\text{ V}$, $R_L = 10\text{ k}$	OPA375 ⁽²⁾	8	10	mV	
		Positive rail headroom	$V_S = 5.5\text{ V}$, $R_L = \text{no load}$	OPA2/4375 ⁽³⁾		7		
			$V_S = 5.5\text{ V}$, $R_L = 2\text{ k}\Omega$			35		
			$V_S = 5.5\text{ V}$, $R_L = 10\text{ k}\Omega$			5		14
		Negative rail headroom	$V_S = 5.5\text{ V}$, $R_L = \text{no load}$			7		
			$V_S = 5.5\text{ V}$, $R_L = 2\text{ k}\Omega$			35		
$V_S = 5.5\text{ V}$, $R_L = 10\text{ k}\Omega$			5		14			
I_{SC}	Short-circuit current			OPA2/4375 ⁽³⁾	± 68		mA	
C_{LOAD}	Capacitive load drive				See Figure 7-58			
Z_O	Open-loop output impedance	$f = 10\text{ MHz}$, $I_O = 0\text{ A}$		OPA375 ⁽²⁾	160		Ω	
		$f = 2\text{ MHz}$, $I_O = 0\text{ A}$		OPA2/4375 ⁽³⁾	165		Ω	
POWER SUPPLY								
I_Q	Quiescent current per amplifier	$V_S = 5.5\text{ V}$, $I_O = 0\text{ A}$		OPA375 ⁽²⁾	890		μA	
					$T_A = -40^\circ\text{C to }125^\circ\text{C}$	1100		
				OPA2/4375 ⁽³⁾	990	1200		
					$T_A = -40^\circ\text{C to }125^\circ\text{C}$	1250		
	Turn-On Time	At $T_A = 25^\circ\text{C}$, $V_S = 5.5\text{ V}$, V_S ramp rate $> 0.3\text{ V}/\mu\text{s}$		OPA2/4375 ⁽³⁾	10		μs	

OPA2375/4375 Specifications: $V_S = (V+) - (V-) = 1.8\text{ V to }5.5\text{ V}$ ($\pm 0.9\text{ V to } \pm 2.75\text{ V}$) at $T_A = 25^\circ\text{C}$, $R_L = 10\text{ k}\Omega$ connected to $V_S / 2$, $V_{CM} = V_S / 2$, and $V_{O\text{ UT}} = V_S / 2$, unless otherwise noted.

OPA375 Specifications: $V_S = (V+) - (V-) = 5.5\text{ V}$ at $T_A = 25^\circ\text{C}$, $R_L = 10\text{ k}\Omega$ connected to $V_S / 2$, $V_{CM} = V_S / 2$, and $V_{O\text{ UT}} = V_S / 2$, unless otherwise noted.

PARAMETER	TEST CONDITIONS	MIN	TYP	MAX	UNIT
SHUTDOWN					
I_{QSD}	Quiescent current per amplifier All amplifiers disabled, $\overline{\text{SHDN}} = V-$		1	3.5	μA
Z_{SHDN}	Output impedance during shutdown Amplifier disabled		10 6		$\text{G}\Omega \parallel \text{pF}$
V_{IH}	Logic high threshold voltage (amplifier enabled)		$(V-) + 1.1\text{ V}$		V
V_{IL}	Logic low threshold voltage (amplifier disabled)		$(V-) + 0.2\text{ V}$		
t_{ON}	Amplifier enable time (full shutdown) ⁽¹⁾ $G = +1, V_{CM} = V-, V_O = 0.1 \times V_S/2$		15		μs
	Amplifier enable time (partial shutdown) ⁽¹⁾ $G = +1, V_{CM} = V-, V_O = 0.1 \times V_S/2$		8		
t_{OFF}	Amplifier disable time ⁽¹⁾ $V_{CM} = V-, V_O = V_S/2$		3		
	$\overline{\text{SHDN}}$ pin input bias current (per pin)	$(V+) \geq \overline{\text{SHDN}} \geq (V-) + 0.9\text{ V}$		0.4	μA
		$(V-) \leq \overline{\text{SHDN}} \leq (V-) + 0.7\text{ V}$		0.25	

- (1) Disable time (t_{OFF}) and enable time (t_{ON}) are defined as the time interval between the 50% point of the signal applied to the $\overline{\text{SHDN}}$ pin and the point at which the output voltage reaches the 10% (disable) or 90% (enable) level.
- (2) This electrical characteristic only applies to the single-channel, OPA375
- (3) This electrical characteristic only applies to the dual-channel OPA2375 and quad-channel OPA4375
- (4) Specified by design and characterization; not production tested

7.7 Typical Characteristics: OPA375

at $T_A = 25^\circ\text{C}$, $V_S = 5.5\text{ V}$, $R_L = 10\text{ k}\Omega$ connected to $V_S / 2$, $V_{CM} = V_S / 2$, and $V_{OUT} = V_S / 2$ (unless otherwise noted)

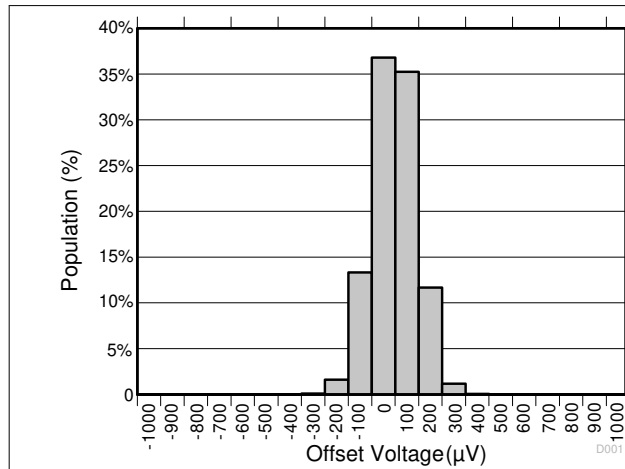

Figure 7-1. Offset Voltage Production Distribution

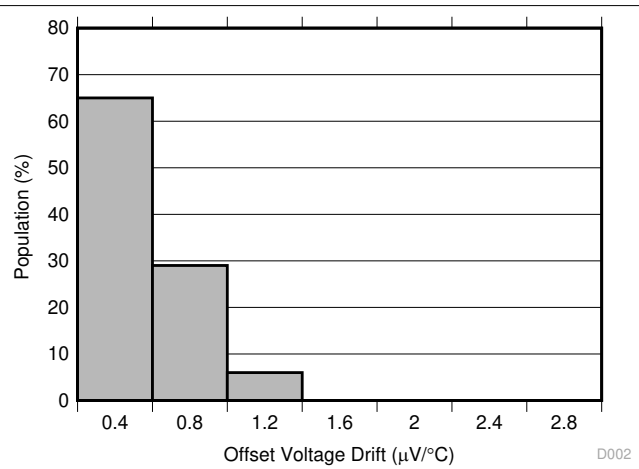

Figure 7-2. Offset Voltage Drift Distribution

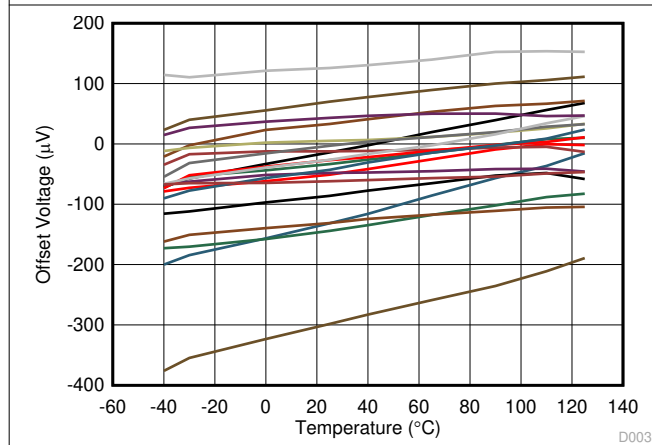

Figure 7-3. Offset Voltage vs Temperature

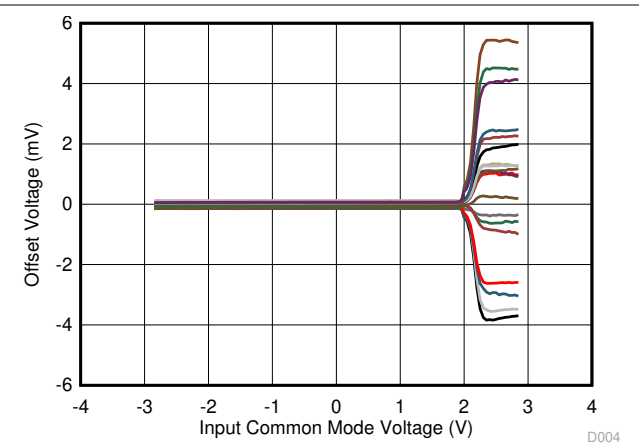

Figure 7-4. Offset Voltage vs Common-Mode Voltage

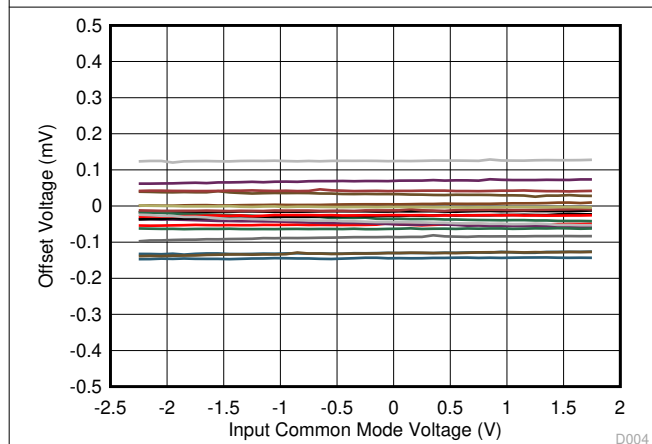

Figure 7-5. Offset Voltage vs Common-Mode Voltage

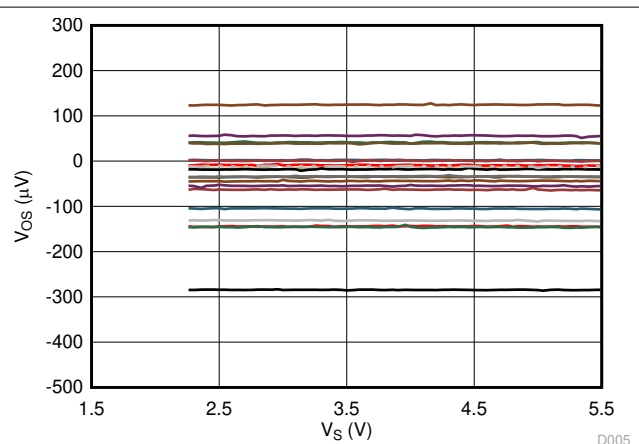

Figure 7-6. Offset Voltage vs Power Supply

7.7 Typical Characteristics: OPA375 (continued)

at $T_A = 25^\circ\text{C}$, $V_S = 5.5\text{ V}$, $R_L = 10\text{ k}\Omega$ connected to $V_S / 2$, $V_{CM} = V_S / 2$, and $V_{OUT} = V_S / 2$ (unless otherwise noted)

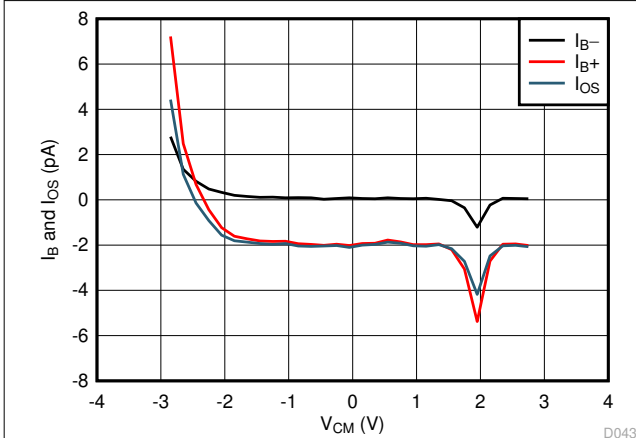

Figure 7-7. I_B and I_{OS} vs Common-Mode Voltage

D043

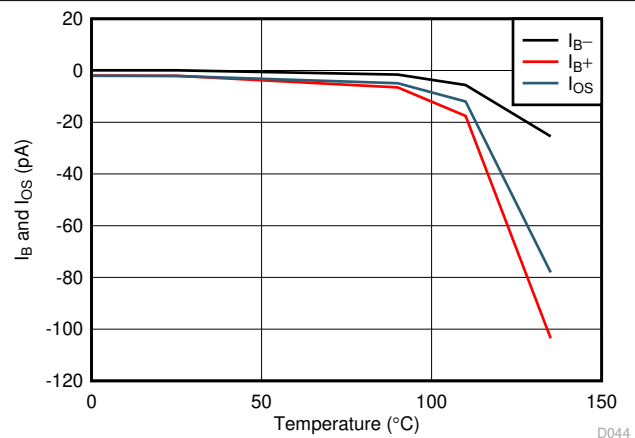

Figure 7-8. I_B and I_{OS} vs Temperature

D044

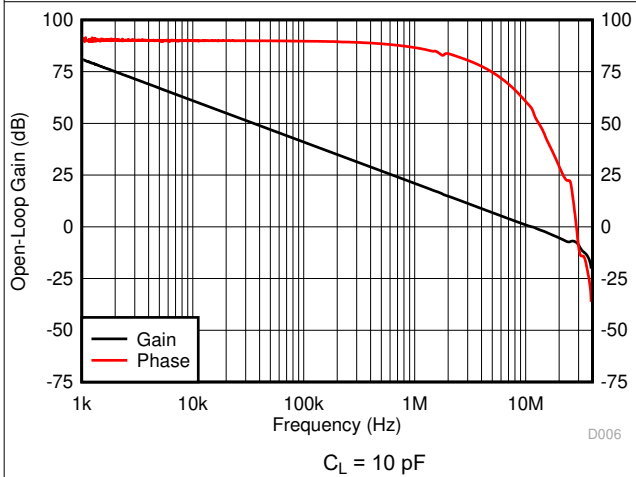

Figure 7-9. Open-Loop Gain and Phase vs Frequency

D006

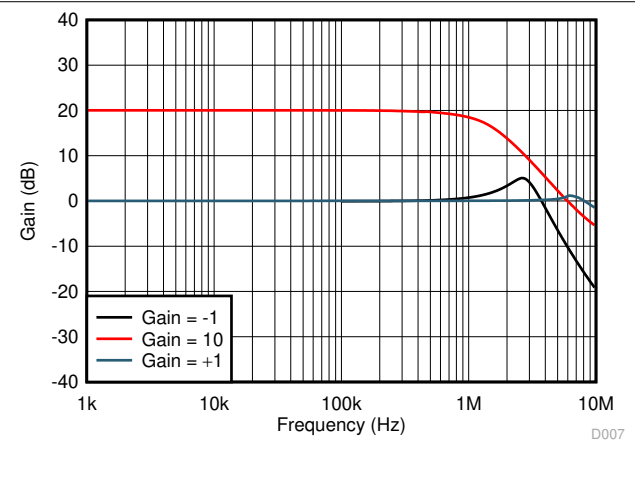

Figure 7-10. Closed-Loop Gain vs Frequency

D007

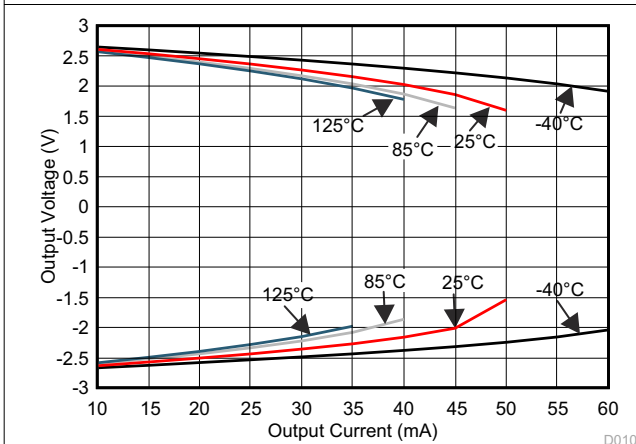

Figure 7-11. V_O vs I Sourcing and Sinking

D010

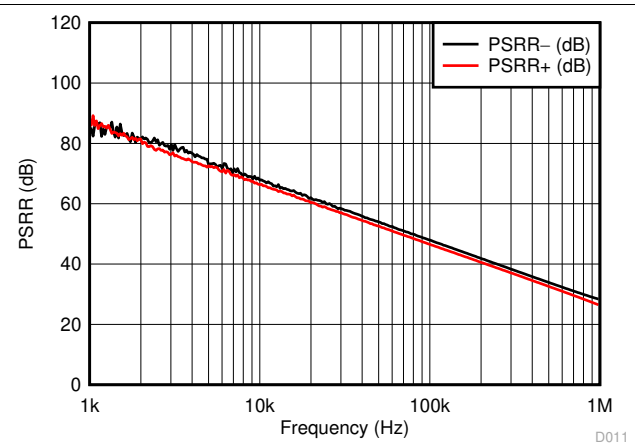

Figure 7-12. PSRR vs Frequency (Referred to Input)

D011

7.7 Typical Characteristics: OPA375 (continued)

at $T_A = 25^\circ\text{C}$, $V_S = 5.5\text{ V}$, $R_L = 10\text{ k}\Omega$ connected to $V_S / 2$, $V_{CM} = V_S / 2$, and $V_{OUT} = V_S / 2$ (unless otherwise noted)

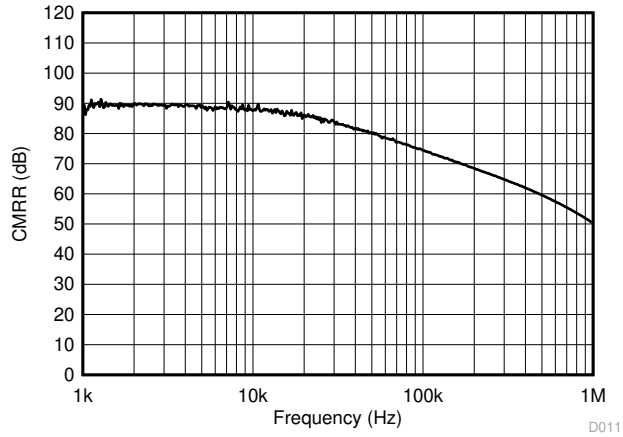
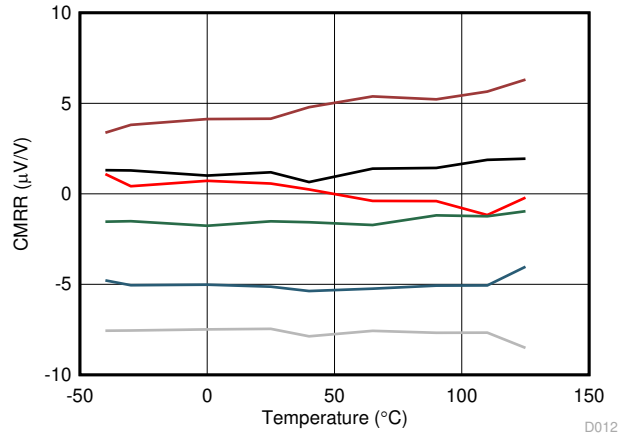

Figure 7-13. CMRR vs Frequency (Referred to Input)



$V_S = 5.5\text{ V}$ $T_A = -40^\circ\text{C}$ to 125°C $V_{CM} = 0\text{ V}$ to 4.3 V

Figure 7-14. CMRR vs Temperature

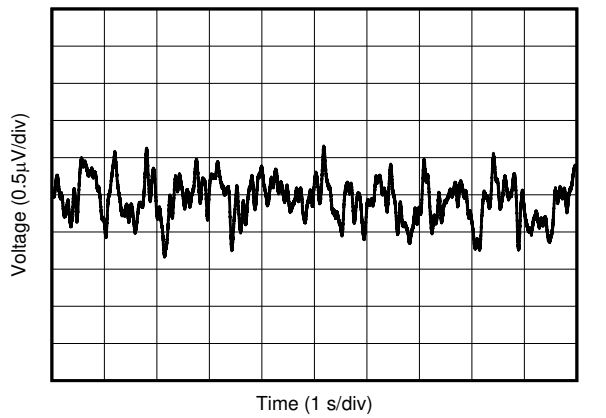

Figure 7-15. 0.1-Hz to 10-Hz Flicker Noise

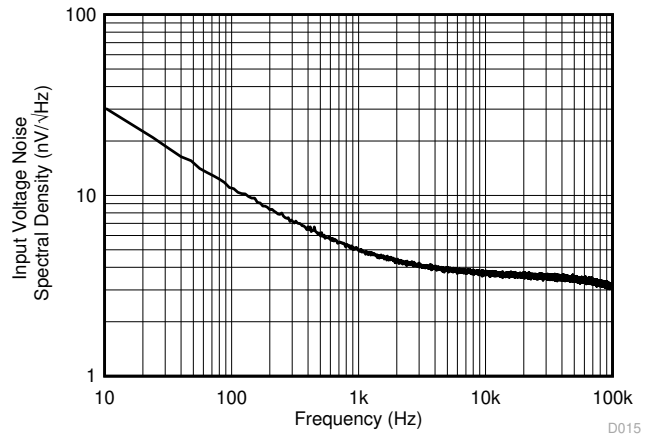
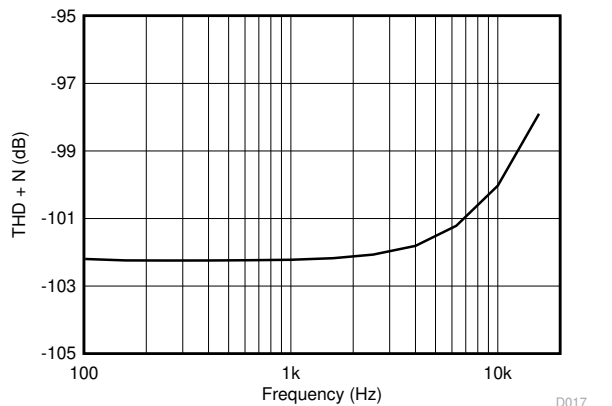
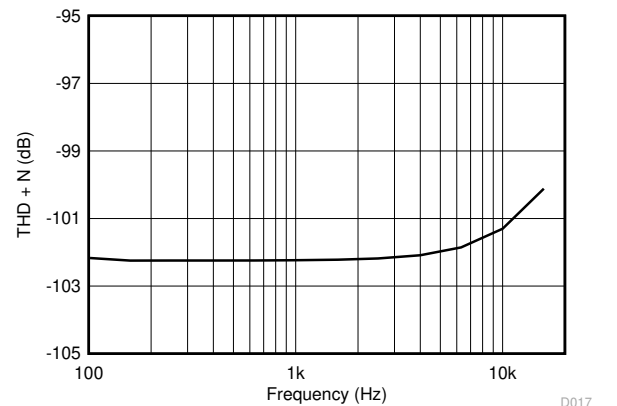

Figure 7-16. Input Voltage Noise Spectral Density vs Frequency



$V_S = 5.5\text{ V}$ $V_{ICM} = 2.5\text{ V}$ $R_L = 2\text{ k}\Omega$
Gain = 1 $BW = 80\text{ kHz}$ $V_{OUT} = 0.5\text{ V}_{rms}$

Figure 7-17. THD + N vs Frequency



$V_S = 5.5\text{ V}$ $V_{ICM} = 2.5\text{ V}$ $R_L = 10\text{ k}\Omega$
Gain = 1 $BW = 80\text{ kHz}$ $V_{OUT} = 0.5\text{ V}_{rms}$

Figure 7-18. THD + N vs Frequency

7.7 Typical Characteristics: OPA375 (continued)

at $T_A = 25^\circ\text{C}$, $V_S = 5.5\text{ V}$, $R_L = 10\text{ k}\Omega$ connected to $V_S / 2$, $V_{CM} = V_S / 2$, and $V_{OUT} = V_S / 2$ (unless otherwise noted)

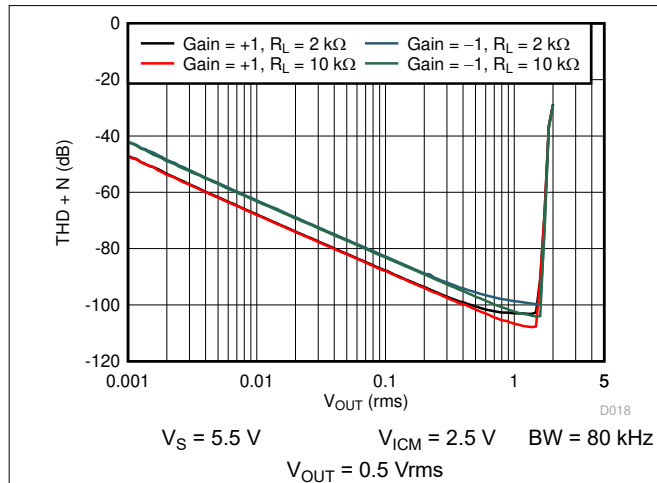

Figure 7-19. THD + N vs Amplitude

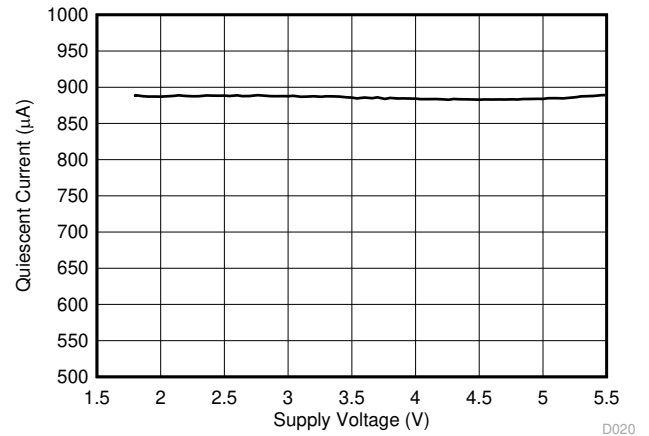

Figure 7-20. Quiescent Current vs Supply Voltage

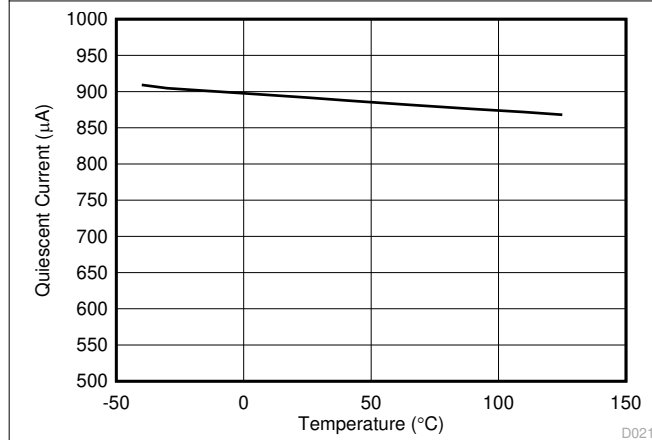

Figure 7-21. Quiescent Current vs Temperature

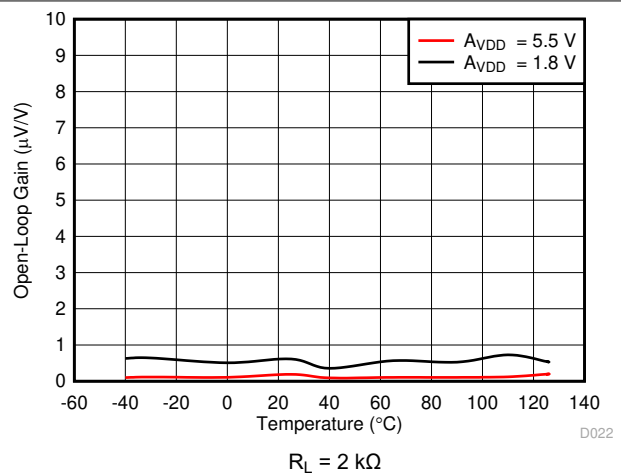

Figure 7-22. Open-Loop Gain vs Temperature

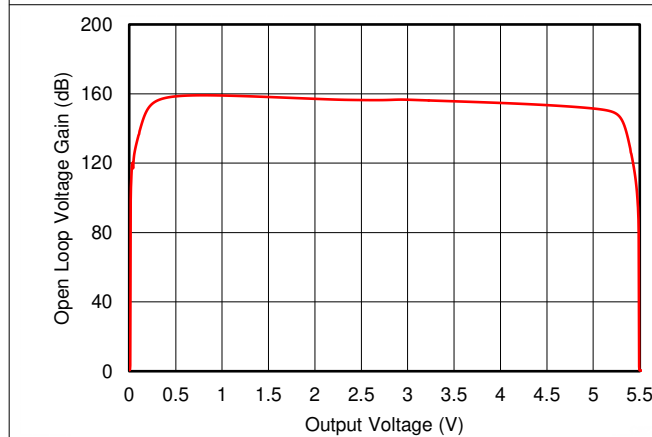

Figure 7-23. Open-Loop Gain vs Output Voltage

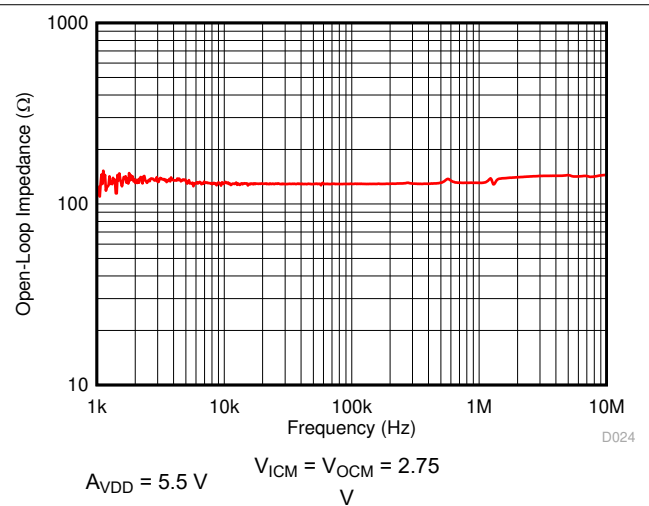

Figure 7-24. Open-Loop Output Impedance vs Frequency

7.7 Typical Characteristics: OPA375 (continued)

at $T_A = 25^\circ\text{C}$, $V_S = 5.5\text{ V}$, $R_L = 10\text{ k}\Omega$ connected to $V_S / 2$, $V_{CM} = V_S / 2$, and $V_{OUT} = V_S / 2$ (unless otherwise noted)

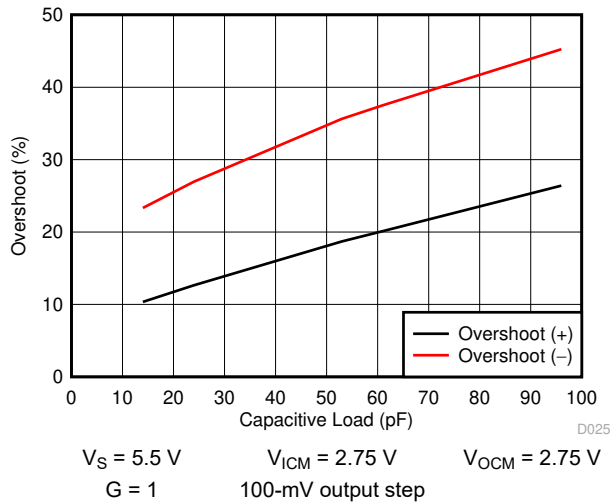

Figure 7-25. Small-Signal Overshoot vs Load Capacitance

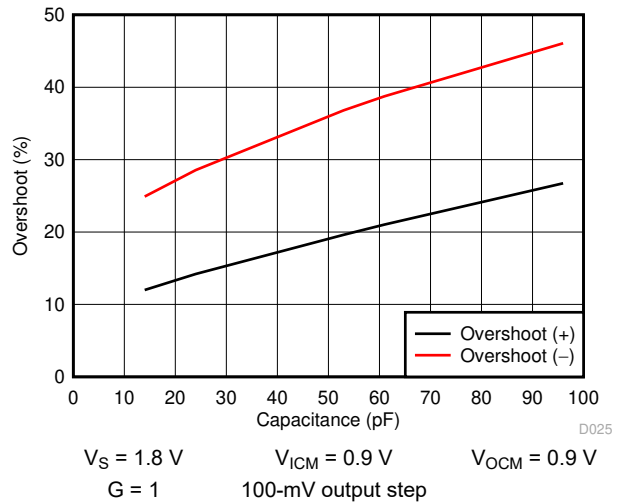

Figure 7-26. Small-Signal Overshoot vs Load Capacitance

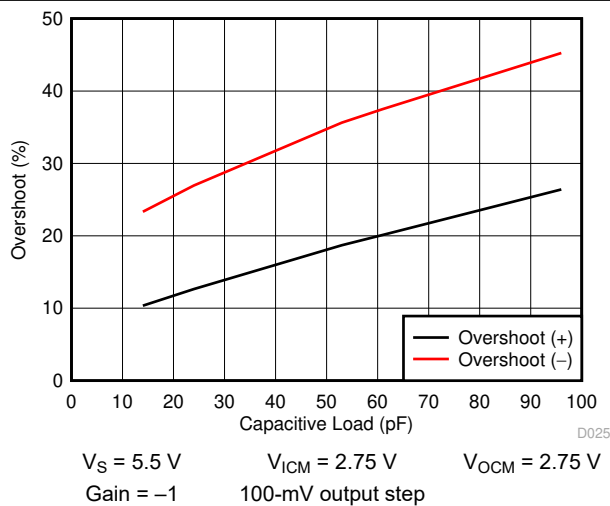

Figure 7-27. Small-Signal Overshoot vs Load Capacitance

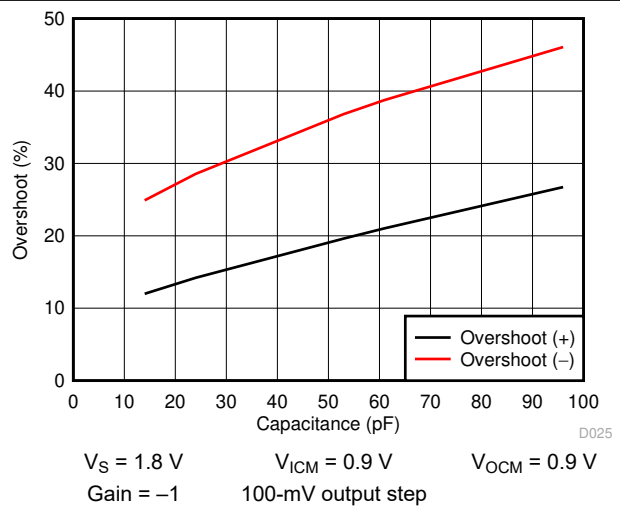

Figure 7-28. Small-Signal Overshoot vs Load Capacitance

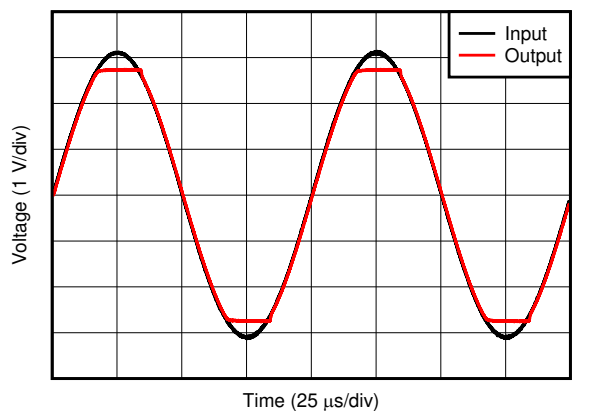

Figure 7-29. No Phase Reversal

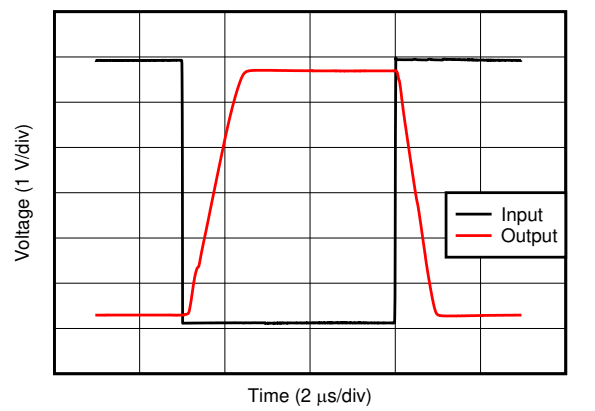
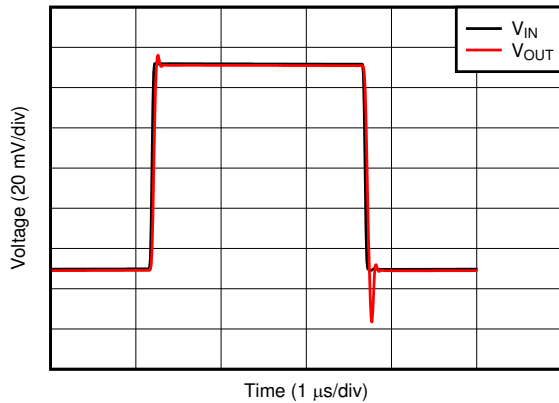

Figure 7-30. Overload Recovery

7.7 Typical Characteristics: OPA375 (continued)

at $T_A = 25^\circ\text{C}$, $V_S = 5.5\text{ V}$, $R_L = 10\text{ k}\Omega$ connected to $V_S / 2$, $V_{CM} = V_S / 2$, and $V_{OUT} = V_S / 2$ (unless otherwise noted)



D030
 $V_S = 1.8\text{ V}$ $V_{ICM} = 0.9\text{ V}$ $V_{OCM} = 0.9\text{ V}$
 $C_L = 30\text{ pF}$ Gain = 1 $V_{IN} = 100\text{ mVpp}$
Figure 7-31. Small-Signal Step Response

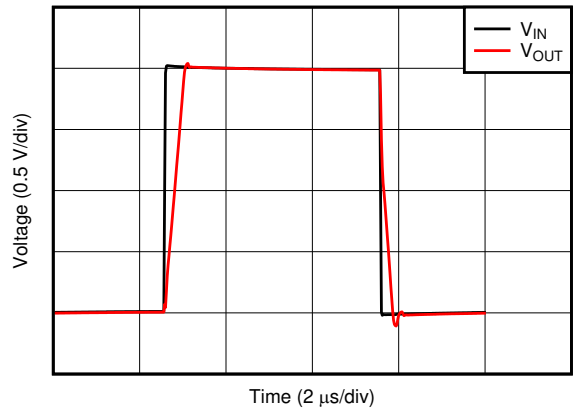

D031
 $V_S = 5.5\text{ V}$ $V_{OCM} = 2.75\text{ V}$ $C_L = 10\text{ pF}$
 $V_{ICM} = 2.75\text{ V}$ Gain = 1 2-V step
Figure 7-32. Large Signal Step Response

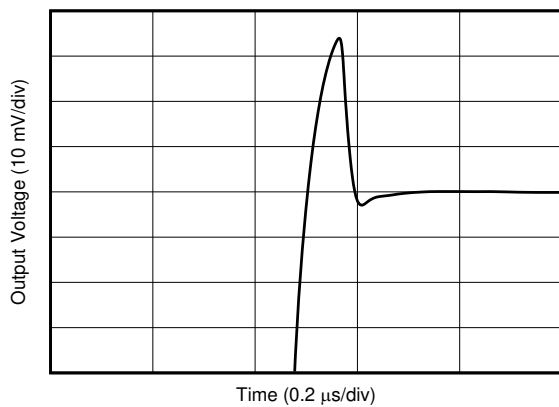

D032
 $V_S = 5.5\text{ V}$ $V_{ICM} = 2.75\text{ V}$ $V_{OCM} = 2.75\text{ V}$
 $C_L = 0$ Gain = 1 5-V step
Figure 7-33. Large Signal Settling Time (Positive)

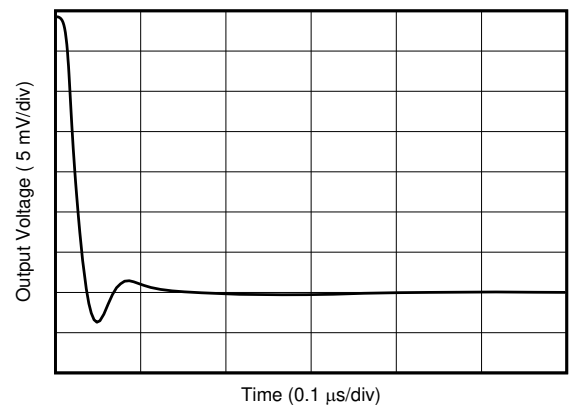

D033
 $V_S = 5.5\text{ V}$ $V_{ICM} = 2.75\text{ V}$ $V_{OCM} = 2.75\text{ V}$
 $C_L = 0$ Gain = 1 5-V step
Figure 7-34. Large Signal Settling Time (Negative)

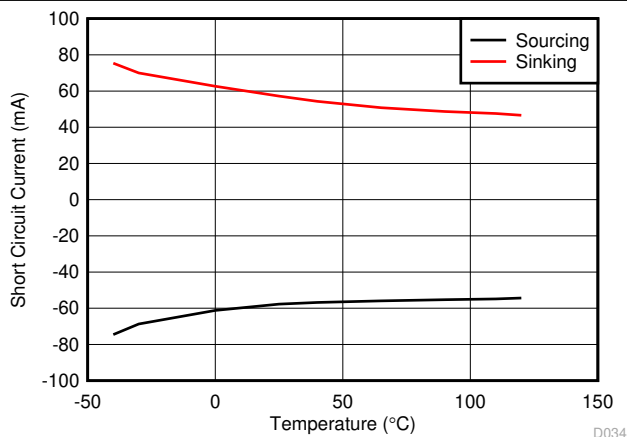

D034
Figure 7-35. Short-Circuit Current vs Temperature

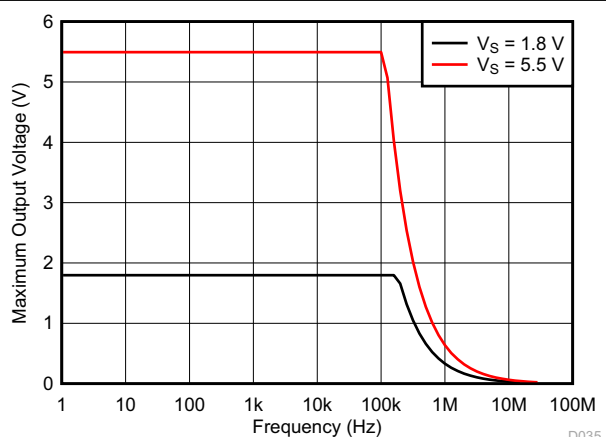

D035
 $V_{ICM} = V_S / 2$ $V_{OCM} = V_S / 2$ $C_L = 10\text{ pF}$
Gain = 1
Figure 7-36. Maximum Output Voltage vs Frequency

7.7 Typical Characteristics: OPA375 (continued)

at $T_A = 25^\circ\text{C}$, $V_S = 5.5\text{ V}$, $R_L = 10\text{ k}\Omega$ connected to $V_S / 2$, $V_{CM} = V_S / 2$, and $V_{OUT} = V_S / 2$ (unless otherwise noted)

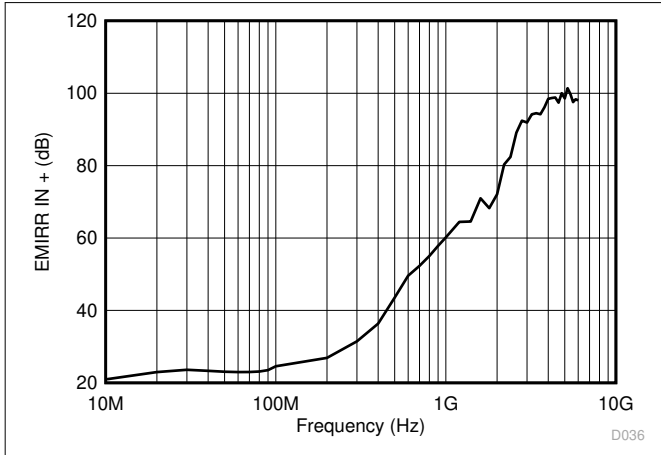

Figure 7-37. Electromagnetic Interference Rejection Ratio Referred to Noninverting Input (EMIRR+) vs Frequency

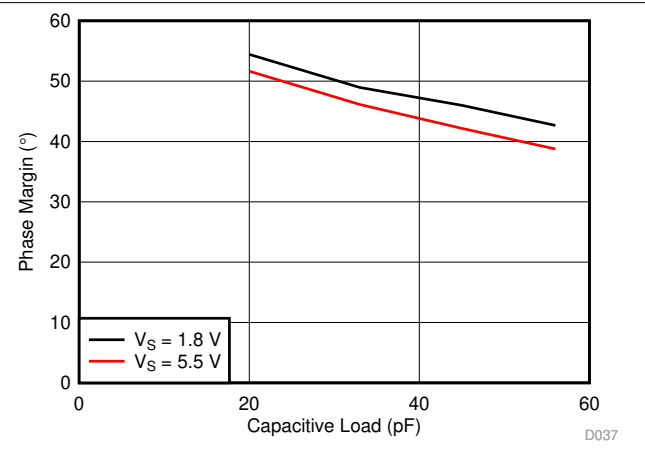

Figure 7-38. Phase Margin vs Capacitive Load

$$V_{ICM} = V_{OCM} = V_S / 2$$

7.8 Typical Characteristics: OPA2375

at $T_A = 25^\circ\text{C}$, $V_S = \pm 2.75\text{ V}$, $R_L = 10\text{ k}\Omega$ connected to $V_S / 2$, $V_{CM} = V_S / 2$, and $V_{OUT} = V_S / 2$, unless otherwise noted.

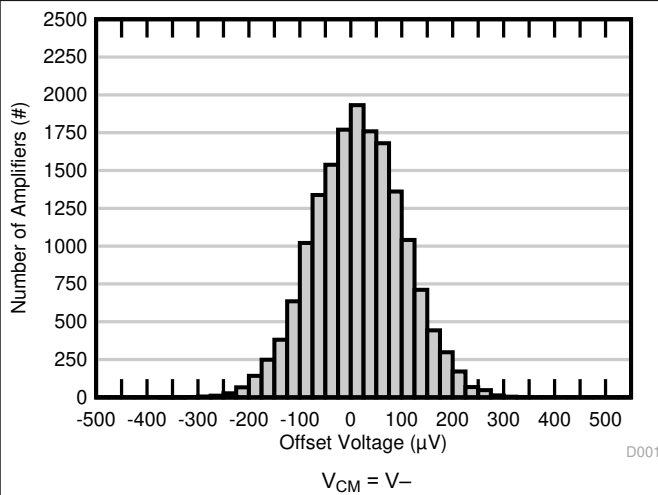

Figure 7-39. Offset Voltage Production Distribution

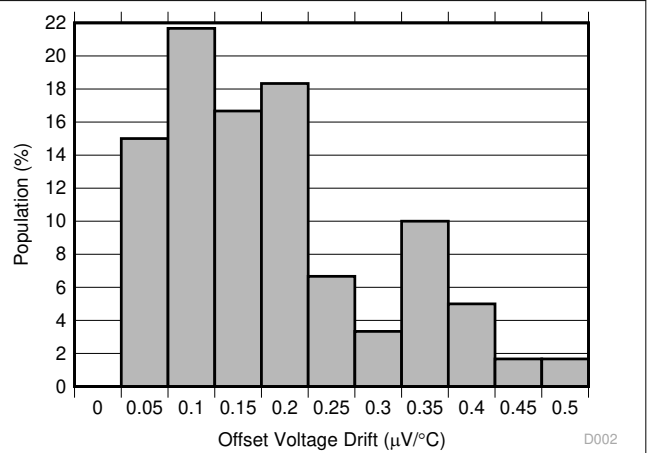

Figure 7-40. Offset Voltage Drift Distribution

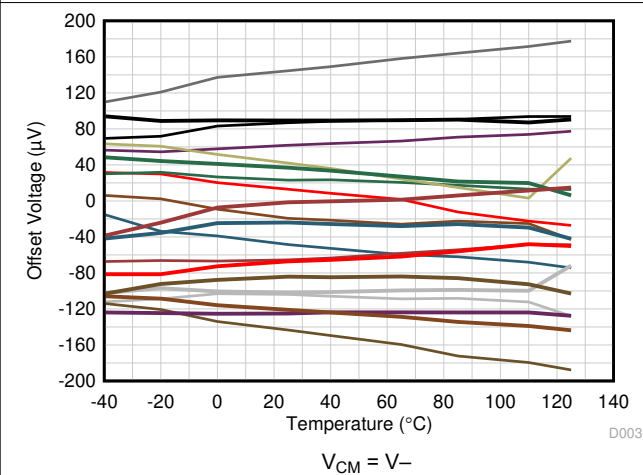

Figure 7-41. Offset Voltage vs Temperature (PMOS Input Pair)

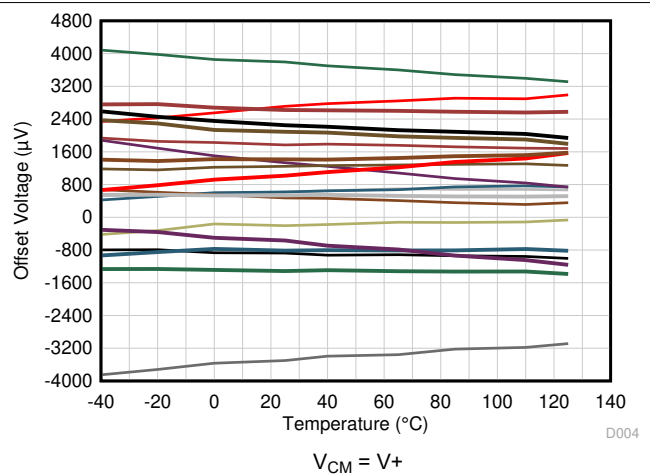

Figure 7-42. Offset Voltage vs Temperature (NMOS Input Pair)

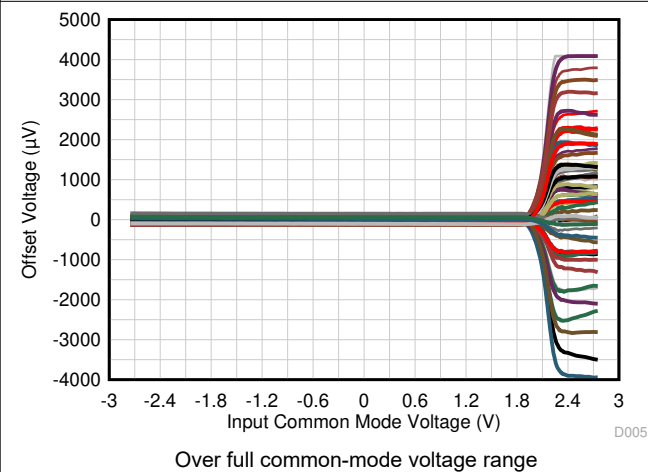

Figure 7-43. Offset Voltage vs Common-Mode Voltage (Full Range)

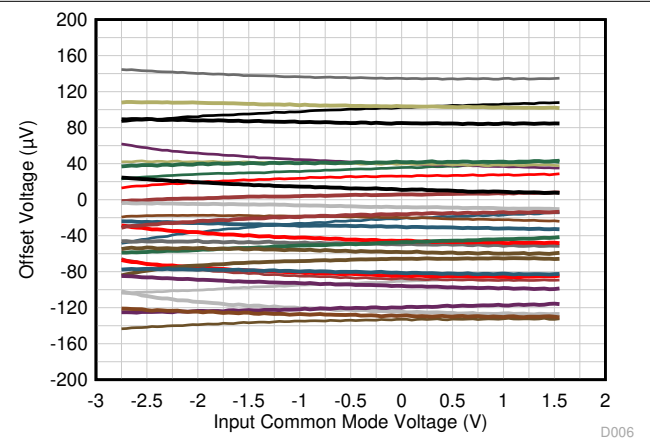

Figure 7-44. Offset Voltage vs Common-Mode Voltage (PMOS Input Pair)

7.8 Typical Characteristics: OPA2375 (continued)

at $T_A = 25^\circ\text{C}$, $V_S = \pm 2.75\text{ V}$, $R_L = 10\text{ k}\Omega$ connected to $V_S / 2$, $V_{CM} = V_S / 2$, and $V_{OUT} = V_S / 2$, unless otherwise noted.

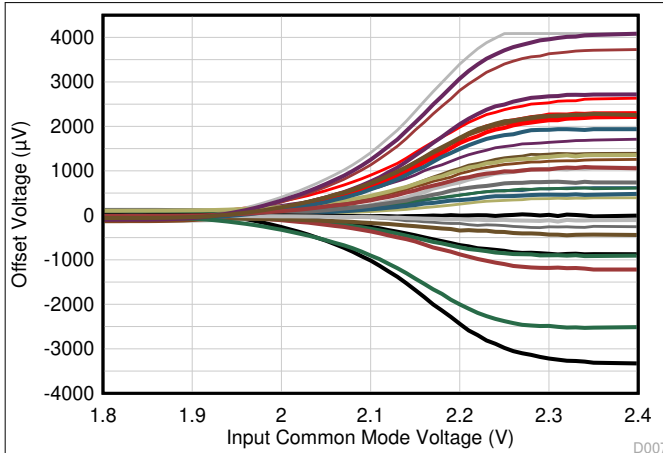

Figure 7-45. Offset Voltage vs Common-Mode Voltage (Transition Region)

D007

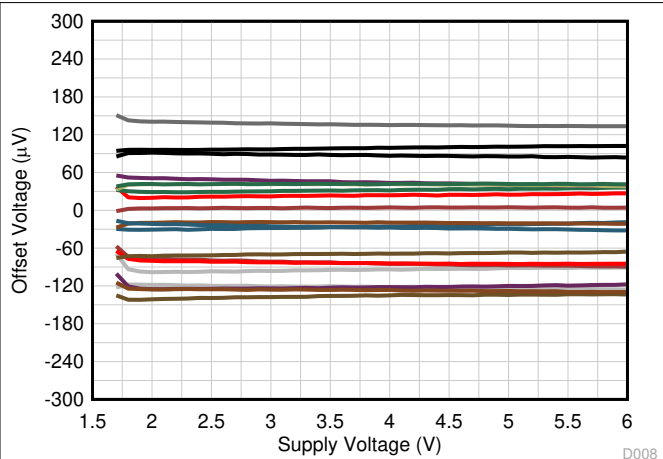

Figure 7-46. Offset Voltage vs Power Supply

D008

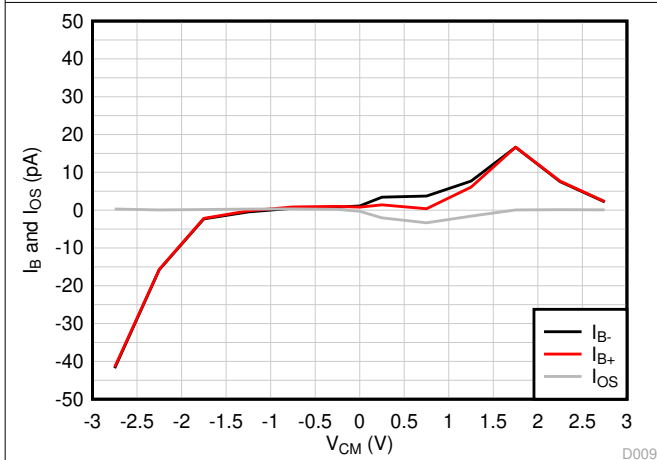

Figure 7-47. I_B and I_{OS} vs Common-Mode Voltage

D009

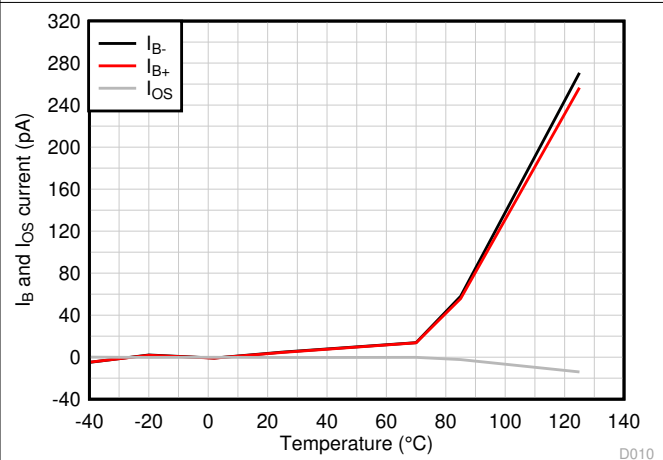

Figure 7-48. I_B and I_{OS} vs Temperature

D010

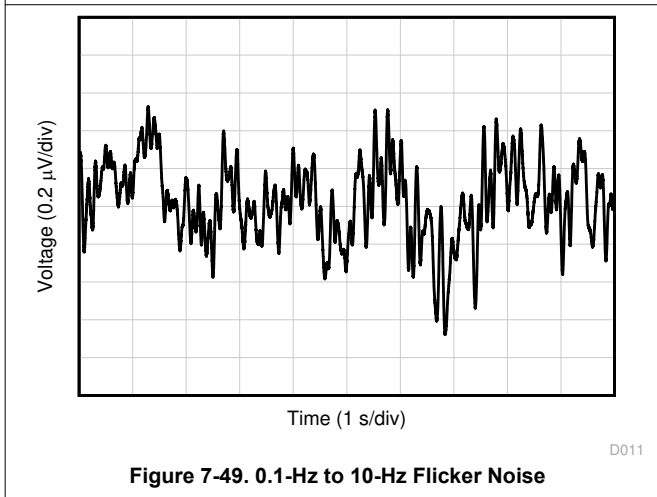

Figure 7-49. 0.1-Hz to 10-Hz Flicker Noise

D011

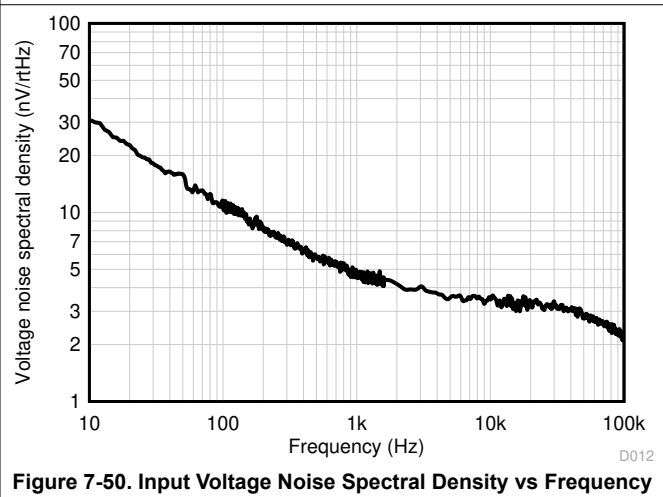

Figure 7-50. Input Voltage Noise Spectral Density vs Frequency

D012

7.8 Typical Characteristics: OPA2375 (continued)

at $T_A = 25^\circ\text{C}$, $V_S = \pm 2.75\text{ V}$, $R_L = 10\text{ k}\Omega$ connected to $V_S / 2$, $V_{CM} = V_S / 2$, and $V_{OUT} = V_S / 2$, unless otherwise noted.

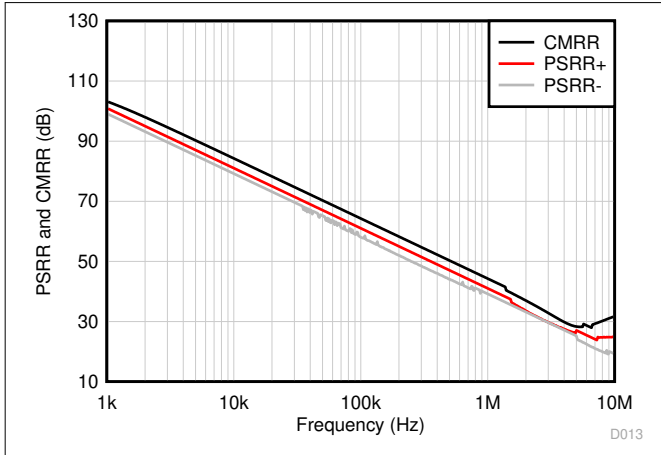
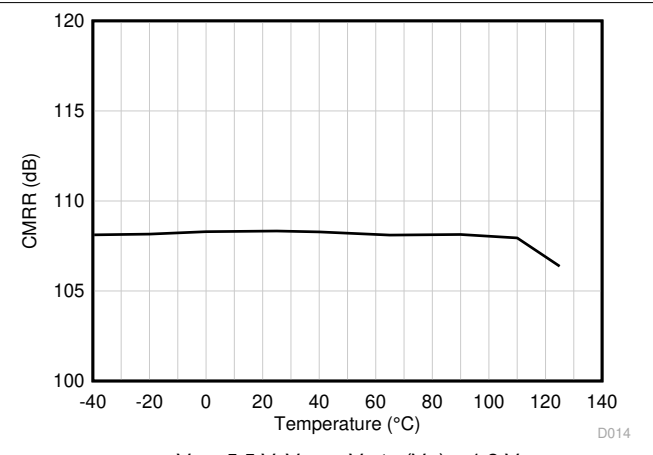
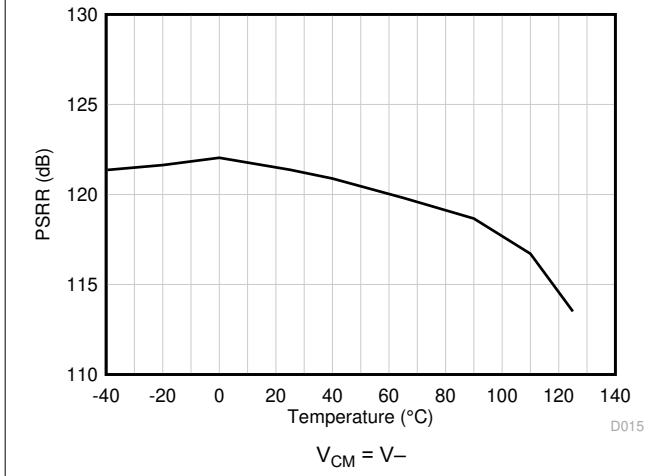

Figure 7-51. CMRR and PSRR vs Frequency (Referred to Input)



$V_S = 5.5\text{ V}$, $V_{CM} = V^- \text{ to } (V^+) - 1.2\text{ V}$

Figure 7-52. CMRR vs Temperature



$V_{CM} = V^-$

Figure 7-53. PSRR vs Temperature

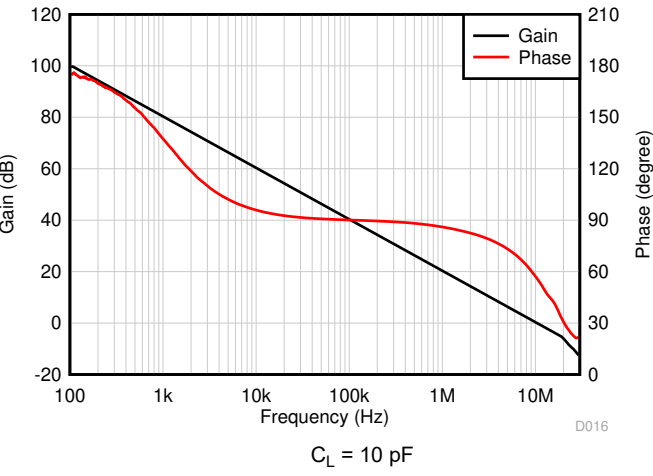

$C_L = 10\text{ pF}$

Figure 7-54. Open-Loop Gain and Phase vs Frequency

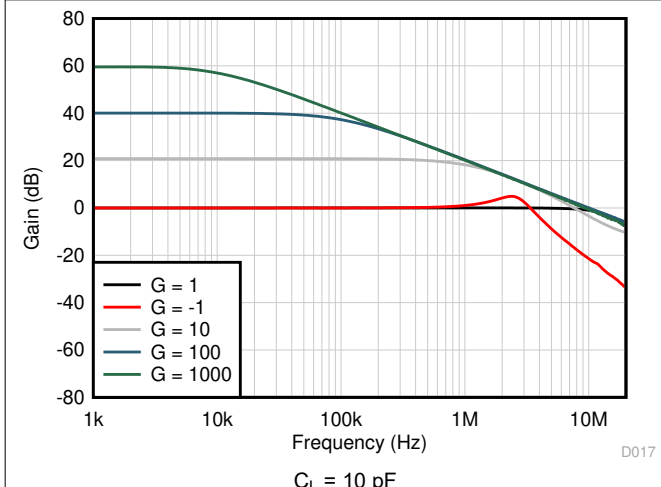

$C_L = 10\text{ pF}$

Figure 7-55. Closed-Loop Gain vs Frequency

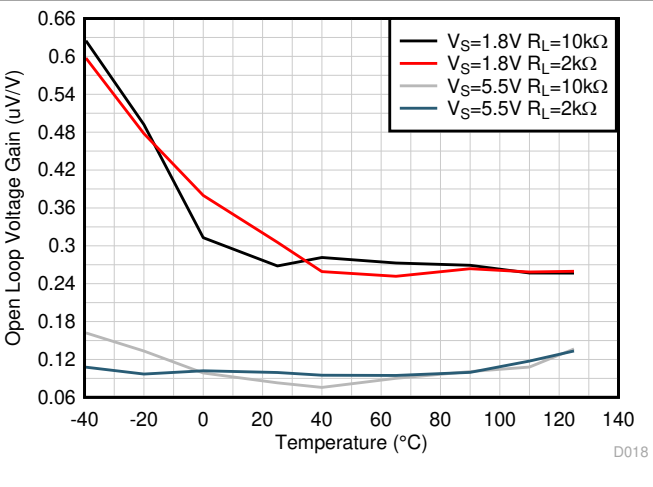
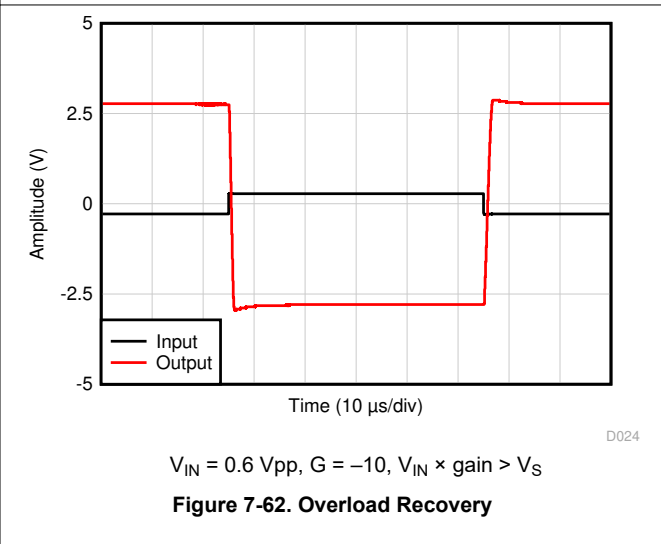
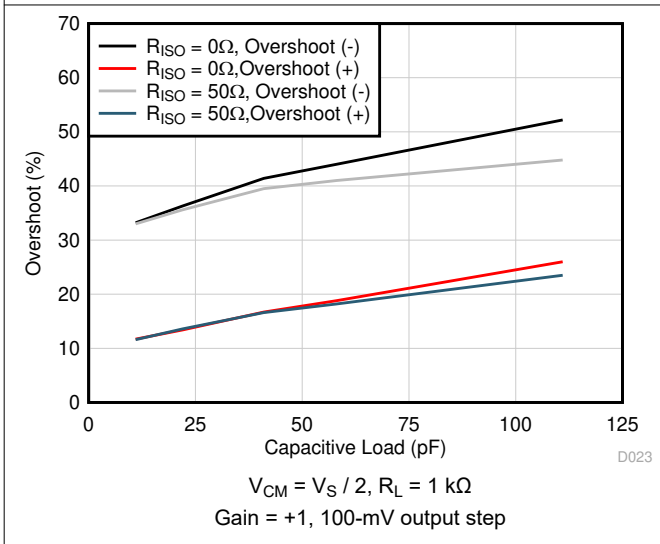
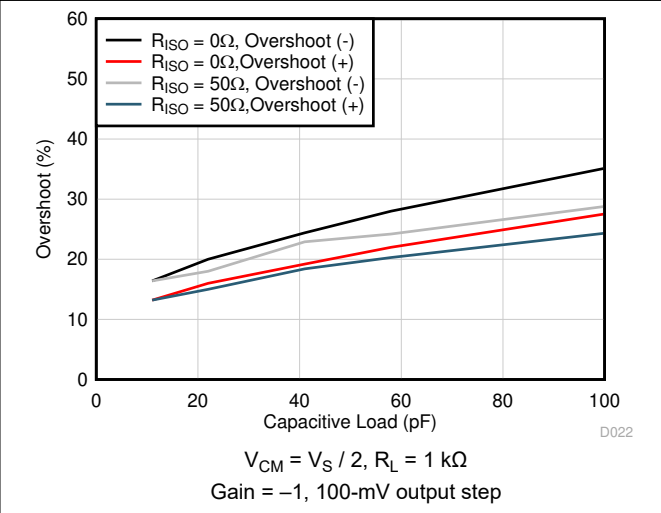
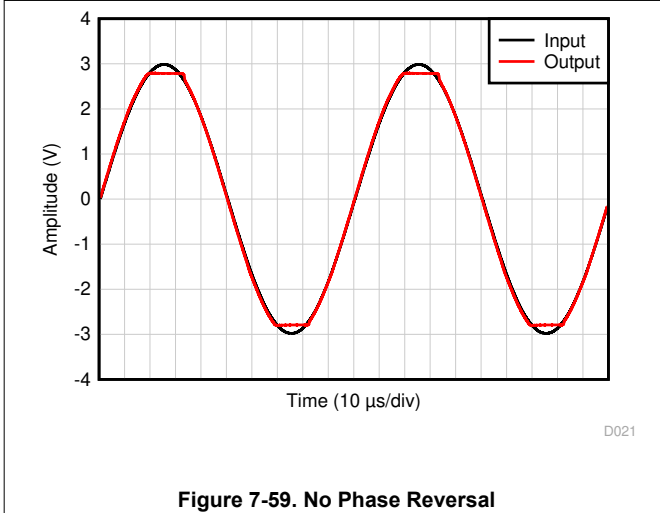
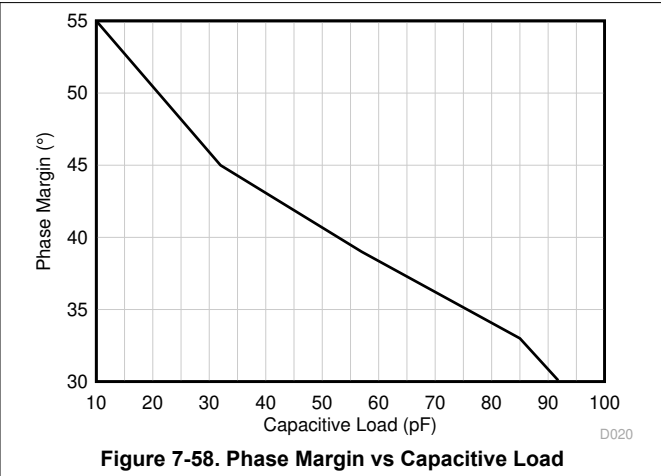
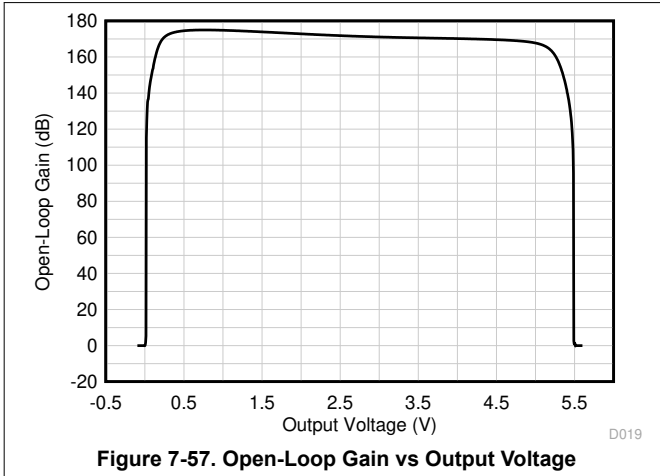

Figure 7-56. Open-Loop Gain vs Temperature

7.8 Typical Characteristics: OPA2375 (continued)

at $T_A = 25^\circ\text{C}$, $V_S = \pm 2.75\text{ V}$, $R_L = 10\text{ k}\Omega$ connected to $V_S / 2$, $V_{CM} = V_S / 2$, and $V_{OUT} = V_S / 2$, unless otherwise noted.



7.8 Typical Characteristics: OPA2375 (continued)

at $T_A = 25^\circ\text{C}$, $V_S = \pm 2.75\text{ V}$, $R_L = 10\text{ k}\Omega$ connected to $V_S / 2$, $V_{CM} = V_S / 2$, and $V_{OUT} = V_S / 2$, unless otherwise noted.

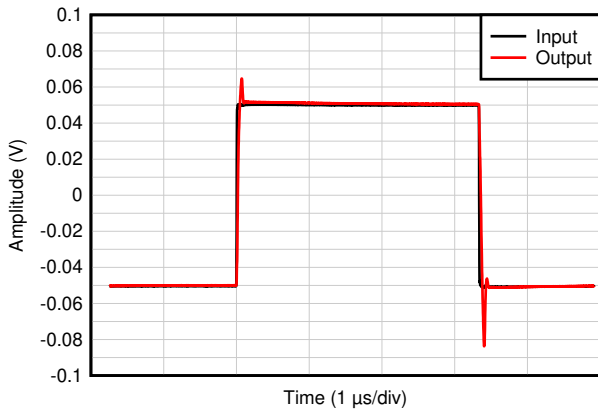

D025

$C_L = 20\text{ pF}$, Gain = 1, $V_{IN} = 100\text{-mVpp}$, $R_L = 1\text{ k}\Omega$

Figure 7-63. Small-Signal Step Response

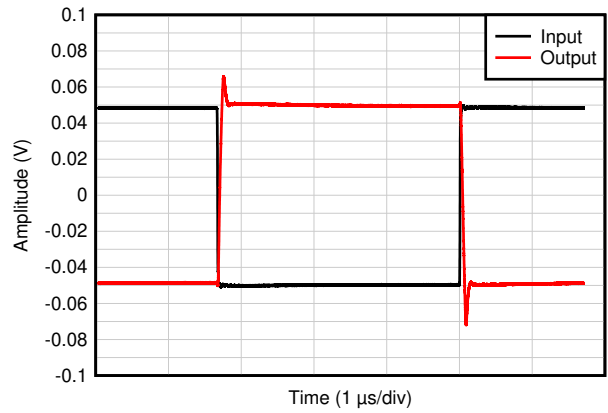

D027

$C_L = 20\text{ pF}$, Gain = -1, $V_{IN} = 100\text{-mVpp}$, $R_L = 1\text{ k}\Omega$

Figure 7-64. Small-Signal Step Response

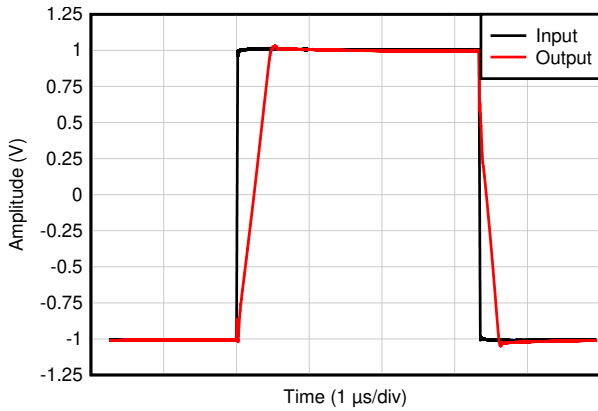

D026

$C_L = 20\text{ pF}$, Gain = +1, $V_{IN} = 2\text{-V step}$, $R_L = 1\text{ k}\Omega$

Figure 7-65. Large Signal Step Response

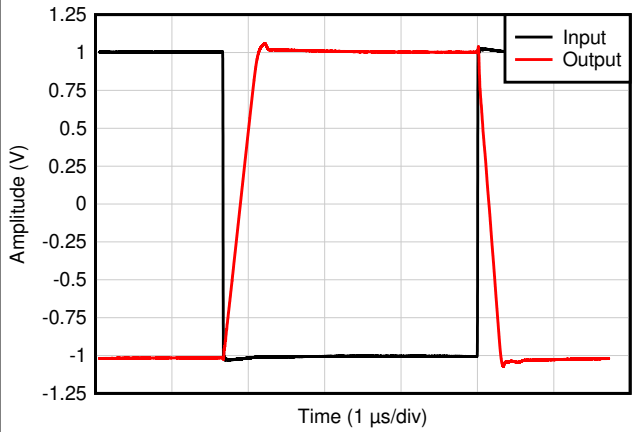

D028

$C_L = 20\text{ pF}$, Gain = -1, $V_{IN} = 2\text{-V step}$, $R_L = 1\text{ k}\Omega$

Figure 7-66. Large Signal Step Response

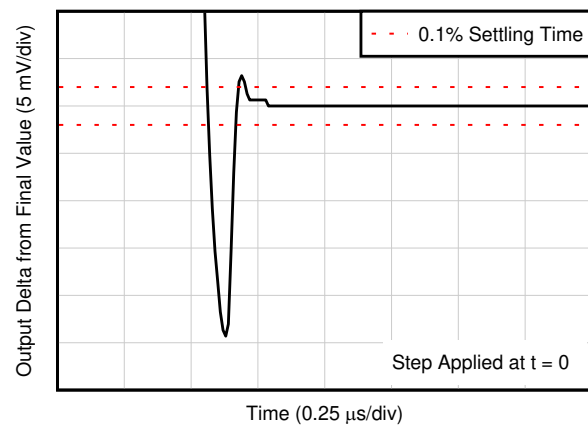

D029

$C_L = 20\text{ pF}$, Gain = 1, $V_{IN} = 2\text{-V step}$

Figure 7-67. Large Signal Settling Time (Positive)

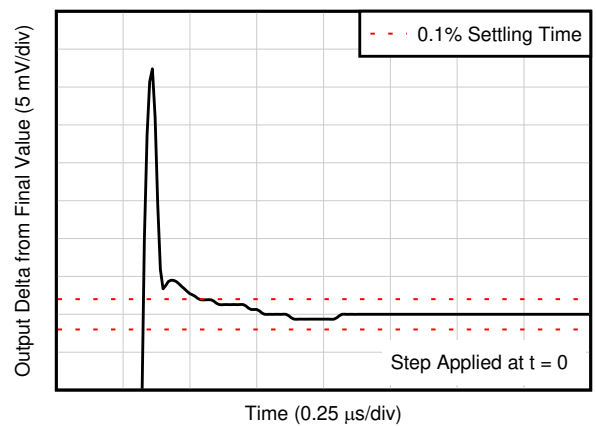

D050

$C_L = 20\text{ pF}$, Gain = -1, $V_{IN} = 2\text{-V step}$

Figure 7-68. Large Signal Settling Time (Negative)

7.8 Typical Characteristics: OPA2375 (continued)

at $T_A = 25^\circ\text{C}$, $V_S = \pm 2.75\text{ V}$, $R_L = 10\text{ k}\Omega$ connected to $V_S / 2$, $V_{CM} = V_S / 2$, and $V_{OUT} = V_S / 2$, unless otherwise noted.

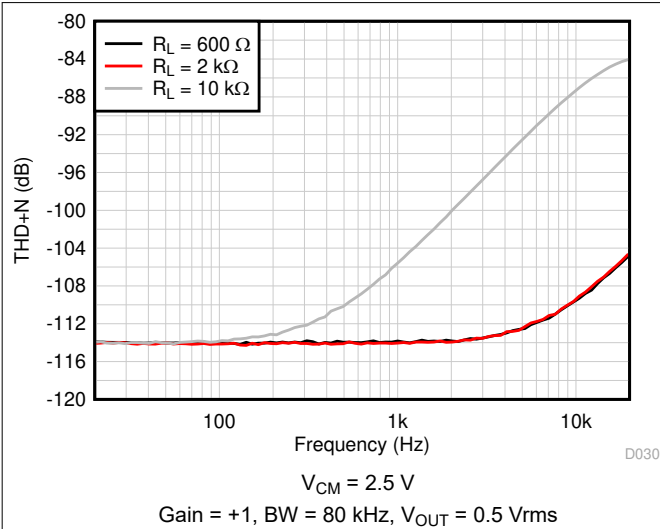

Figure 7-69. THD + N vs Frequency

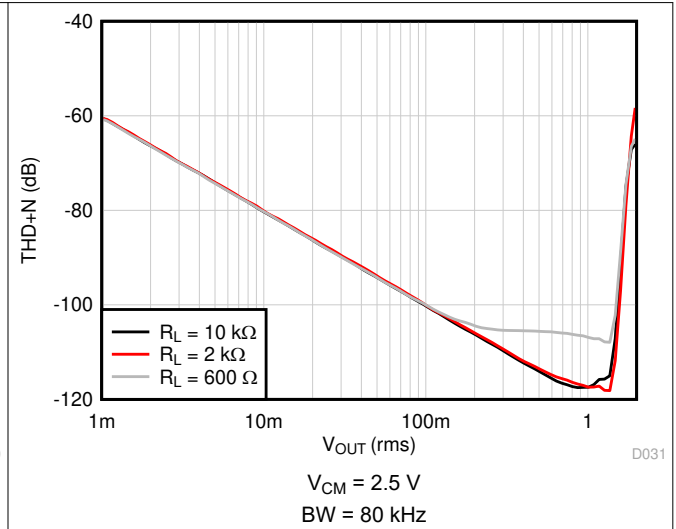

Figure 7-70. THD + N vs Amplitude

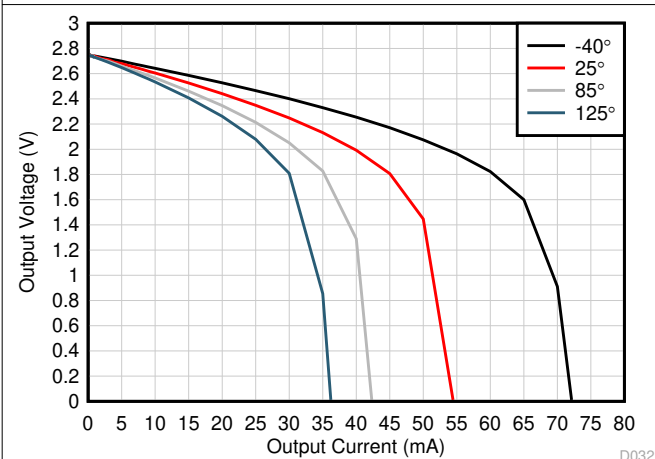

Figure 7-71. V_{OUT} vs Sourcing Current

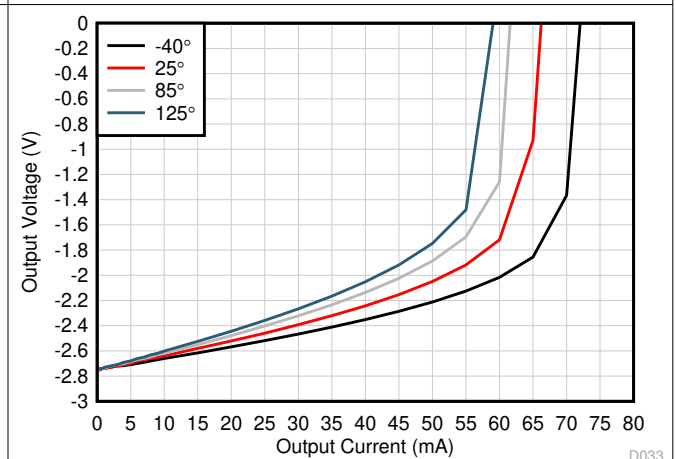

Figure 7-72. V_{OUT} vs Sinking Current

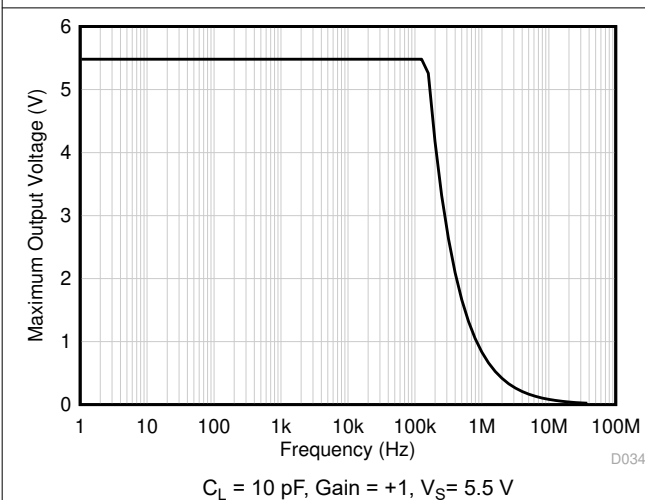

Figure 7-73. Maximum Output Voltage vs Frequency

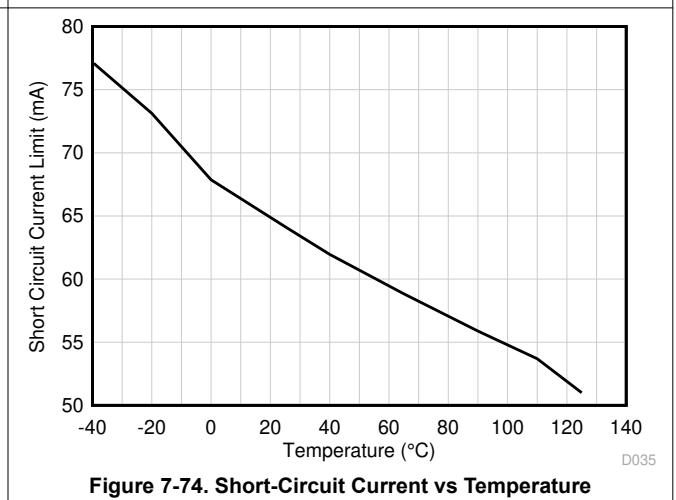

Figure 7-74. Short-Circuit Current vs Temperature

7.8 Typical Characteristics: OPA2375 (continued)

at $T_A = 25^\circ\text{C}$, $V_S = \pm 2.75\text{ V}$, $R_L = 10\text{ k}\Omega$ connected to $V_S / 2$, $V_{CM} = V_S / 2$, and $V_{OUT} = V_S / 2$, unless otherwise noted.

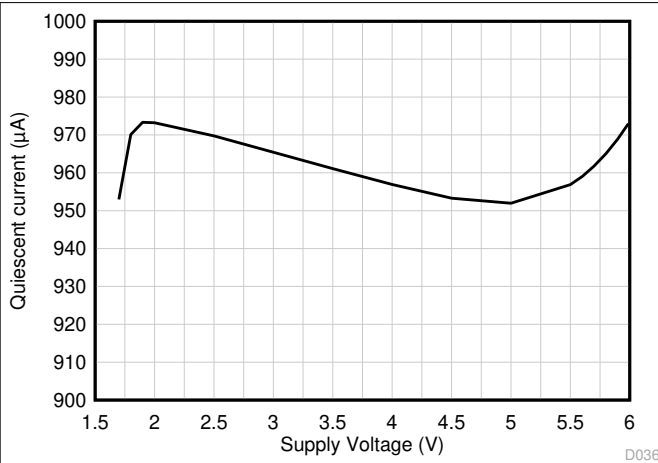

Figure 7-75. Quiescent Current vs Supply Voltage

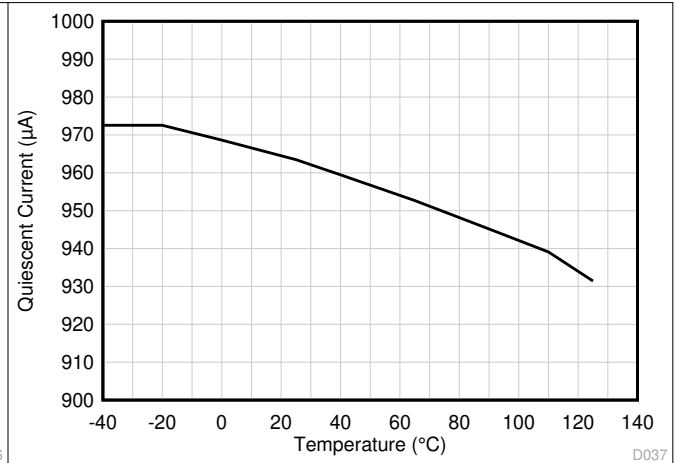

Figure 7-76. Quiescent Current vs Temperature

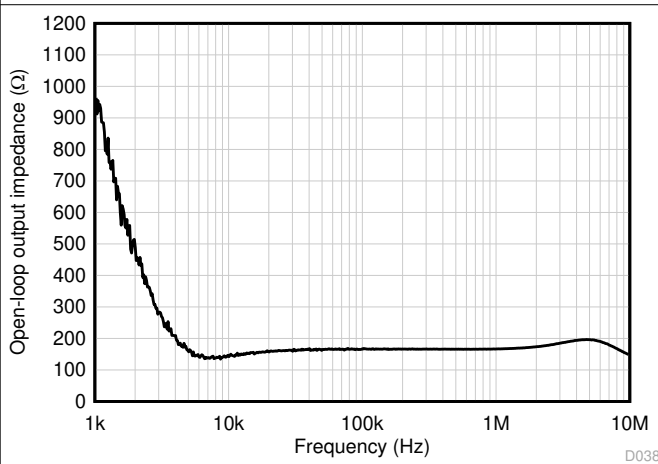
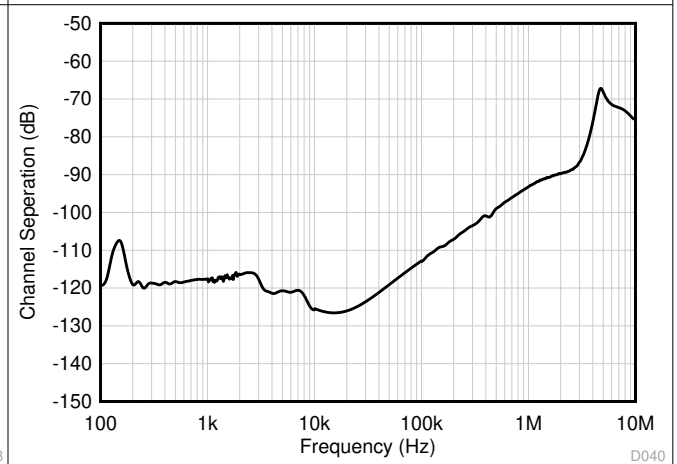

Figure 7-77. Open-Loop Output Impedance vs Frequency



$A_{VDD} = 5.5\text{ V}$, $V_{ICM} = V_{OCM} = 2.75\text{ V}$

Figure 7-78. Channel Separation vs Frequency

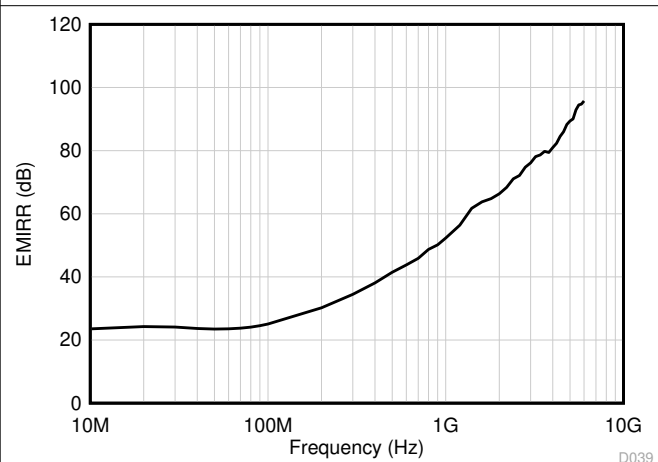
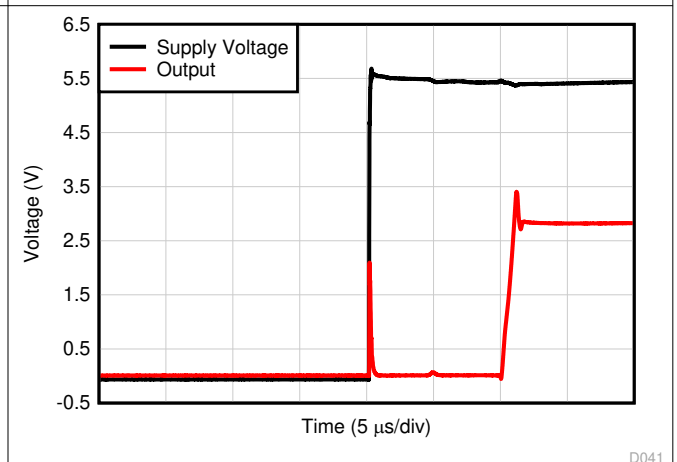

Figure 7-79. Electromagnetic Interference Rejection Ratio Referred to Noninverting Input (EMIRR+) vs Frequency



$V_S = 0\text{ to }5.5\text{ V}$, $V_{OUT} = 0\text{ to }2.75\text{ V}$

Figure 7-80. Turn-On Time

8 Detailed Description

8.1 Overview

The OPAx375 family is an ultra low-noise, rail-to-rail output operational amplifier. The device operates from a supply voltage of 2.25 V to 5.5 V (OPA375) and 1.7 V to 5.5 V (OPA2375 and OPA4375), are unity-gain stable, and suitable for a wide range of general-purpose applications. The input common-mode voltage range includes the negative rail and allows the OPAx375 op amp family to be used in most single-supply applications. Rail-to-rail output swing significantly increases dynamic range, especially in low-supply applications, and makes it suitable for many audio applications and driving sampling analog-to-digital converters (ADCs).

8.2 Functional Block Diagram

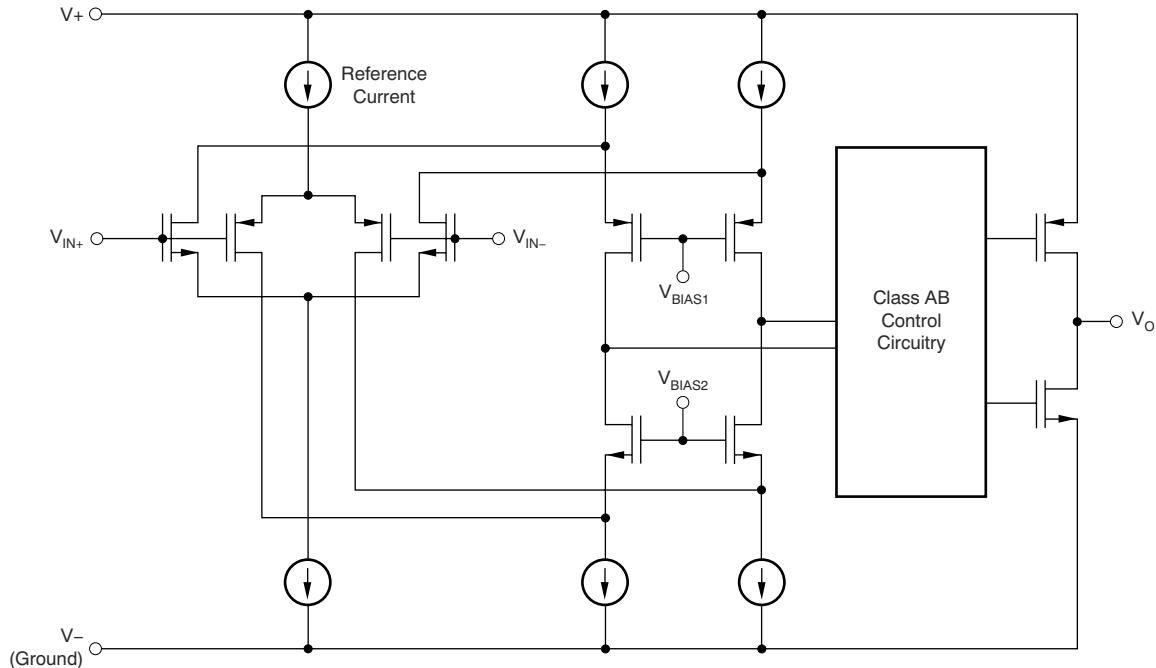

8.3 Feature Description

8.3.1 THD + Noise Performance

The OPAx375 operational amplifier family has excellent distortion characteristics. OPA2375 and OPA4375 THD + Noise is below 0.00015% ($G = +1$, $V_O = 1 V_{RMS}$, $V_{CM} = 1.8 V$, $V_S = 5.5 V$) throughout the audio frequency range, 20 Hz to 20 kHz, with a 10-k Ω load. The broadband noise of the 3.5 nV/ \sqrt{Hz} (OPA2375/4375) and 3.7 nV/ \sqrt{Hz} (OPA375) is extremely low for a 10-MHz general purpose amplifier.

8.3.2 Operating Voltage

The OPAx375 operational amplifier family is fully specified and can operate from 1.7 V to 5.5 V (OPA2375/4375) and 2.25 V to 5.5 V (OPA375). In addition, many specifications apply from $-40^{\circ}C$ to $125^{\circ}C$. Power-supply pins must be bypassed with 0.1- μF ceramic capacitors.

8.3.3 Rail-to-Rail Output

Designed as low-power, low-voltage op amps, the OPAx375 devices deliver a robust output drive capability. A class AB output stage with common-source transistors achieves full rail-to-rail output swing capability. For resistive loads of 10 k Ω , the output swings to within few mV of either supply rail, regardless of the applied power-supply voltage. Different load conditions change the ability of the amplifier to swing close to the rails, see [Figure 7-71](#).

8.3.4 EMI Rejection

The TLV674x uses integrated electromagnetic interference (EMI) filtering to reduce the effects of EMI from sources such as wireless communications and densely-populated boards with a mix of analog signal chain and digital components. EMI immunity can be improved with circuit design techniques; the OPAx375 benefits from these design improvements. Texas Instruments has developed the ability to accurately measure and quantify the immunity of an operational amplifier over a broad frequency spectrum extending from 10 MHz to 6 GHz. [Figure 8-1](#) shows the results of this testing on the TLV674x. [Table 8-1](#) shows the EMIRR IN+ values for the TLV674x at particular frequencies commonly encountered in real-world applications. The [EMI Rejection Ratio of Operational Amplifiers](#) application report contains detailed information on the topic of EMIRR performance as it relates to op amps and is available for download from www.ti.com.

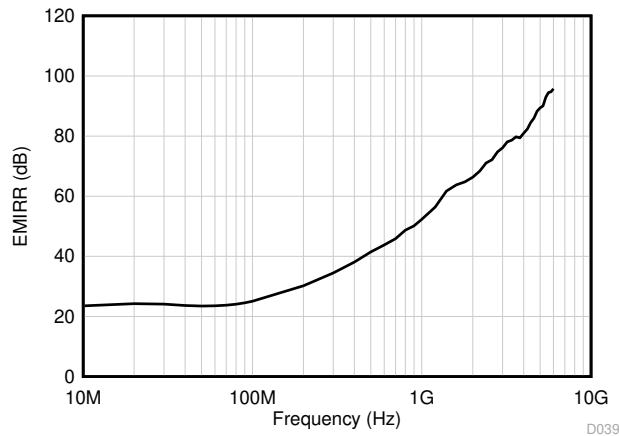

Figure 8-1. EMIRR Testing

Table 8-1. OPAx375 EMIRR IN+ for Frequencies of Interest

FREQUENCY	APPLICATION OR ALLOCATION	EMIRR IN+
400 MHz	Mobile radio, mobile satellite, space operation, weather, radar, ultra-high frequency (UHF) applications	59.5 dB
900 MHz	Global system for mobile communications (GSM) applications, radio communication, navigation, GPS (to 1.6 GHz), GSM, aeronautical mobile, UHF applications	68.9 dB
1.8 GHz	GSM applications, mobile personal communications, broadband, satellite, L-band (1 GHz to 2 GHz)	77.8 dB
2.4 GHz	802.11b, 802.11g, 802.11n, Bluetooth®, mobile personal communications, industrial, scientific and medical (ISM) radio band, amateur radio and satellite, S-band (2 GHz to 4 GHz)	78.0 dB
3.6 GHz	Radiolocation, aero communication and navigation, satellite, mobile, S-band	88.8 dB
5 GHz	802.11a, 802.11n, aero communication and navigation, mobile communication, space and satellite operation, C-band (4 GHz to 8 GHz)	87.6 dB

8.3.5 Electrical Overstress

Designers often ask questions about the capability of an operational amplifier to withstand electrical overstress (EOS). These questions tend to focus on the device inputs, but may involve the supply voltage pins or even the output pin. Each of these different pin functions have electrical stress limits determined by the voltage breakdown characteristics of the particular semiconductor fabrication process and specific circuits connected to the pin. Additionally, internal electrostatic discharge (ESD) protection is built into these circuits to protect them from accidental ESD events both before and during product assembly.

Having a good understanding of this basic ESD circuitry and its relevance to an electrical overstress event is helpful. Figure 8-2 shows an illustration of the ESD circuits contained in the OPAx375 (indicated by the dashed line area). The ESD protection circuitry involves several current-steering diodes connected from the input and output pins and routed back to the internal power-supply lines, where the diodes meet at an absorption device or the power-supply ESD cell, internal to the operational amplifier. This protection circuitry is intended to remain inactive during normal circuit operation.

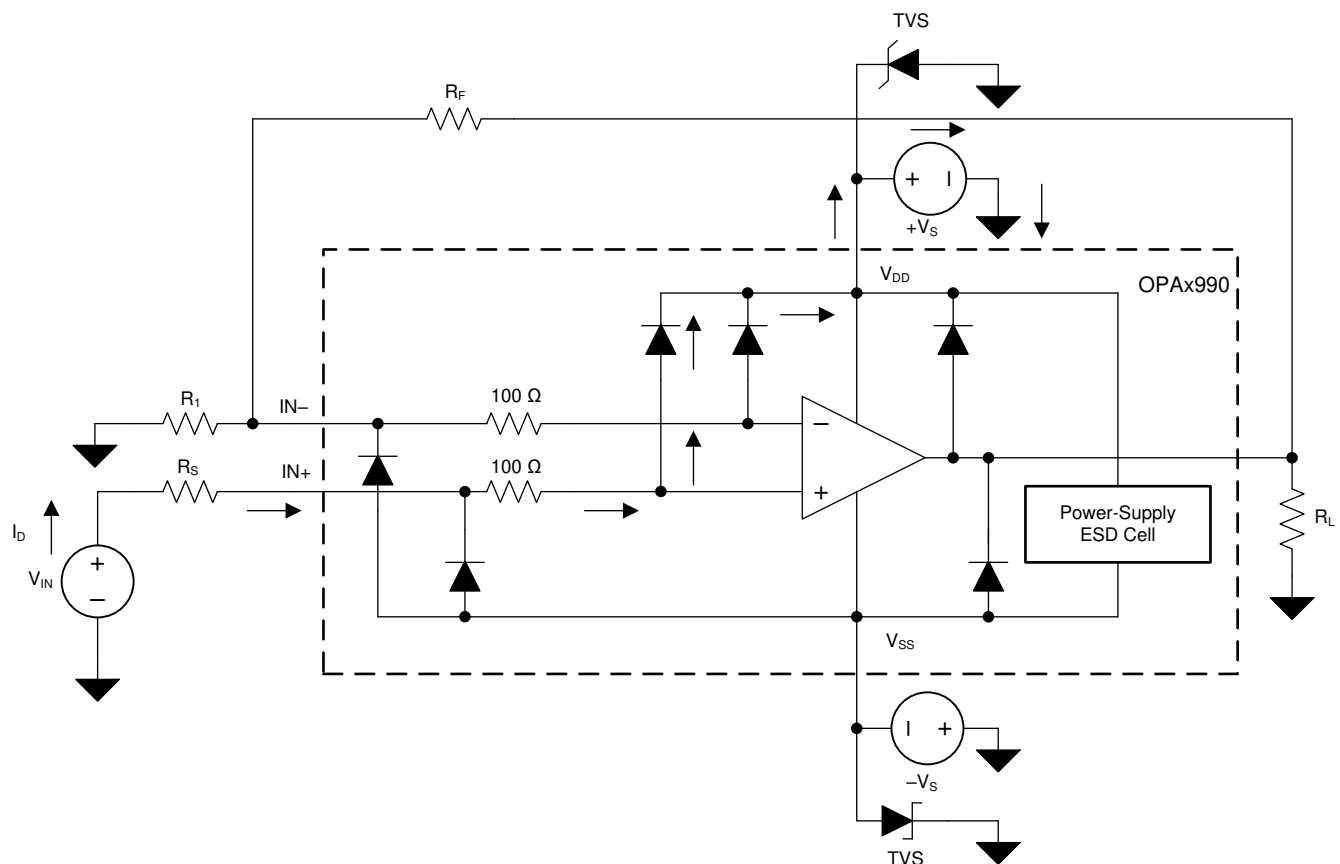

Figure 8-2. Equivalent Internal ESD Circuitry Relative to a Typical Circuit Application

An ESD event is very short in duration and very high voltage (for example; 1 kV, 100 ns), whereas an EOS event is long in duration and lower voltage (for example; 50 V, 100 ms). The ESD diodes are designed for out-of-circuit ESD protection (that is, during assembly, test, and storage of the device before being soldered to the PCB). During an ESD event, the ESD signal is passed through the ESD steering diodes to an absorption circuit (labeled ESD power-supply circuit). The ESD absorption circuit clamps the supplies to a safe level.

Although this behavior is necessary for out-of-circuit protection, excessive current and damage is caused if activated in-circuit. A transient voltage suppressor (TVS) can be used to prevent against damage caused by turning on the ESD absorption circuit during an in-circuit ESD event. Using the appropriate current limiting resistors and TVS diodes allows for the use of device ESD diodes to protect against EOS events.

The OPAx375 family incorporates internal electrostatic discharge (ESD) protection circuits on all pins, as shown above. These ESD protection diodes also provide in-circuit, input overdrive protection, as long as the current is limited to 10 mA as stated in Section 7.1. Figure 8-3 shows how a series input resistor may be added to the driven input to limit the input current. The added resistor contributes thermal noise at the amplifier input and its value should be kept to a minimum in noise-sensitive applications.

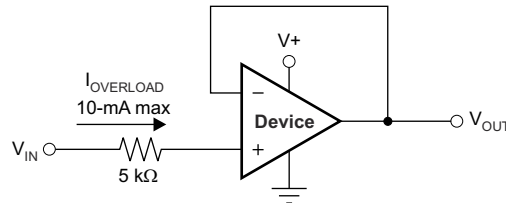

Figure 8-3. Input Current Protection

8.3.6 Typical Specifications and Distributions

Designers often have questions about a typical specification of an amplifier in order to design a more robust circuit. Due to natural variation in process technology and manufacturing procedures, every specification of an amplifier will exhibit some amount of deviation from the ideal value, like an amplifier's input offset voltage. These deviations often follow *Gaussian* ("bell curve"), or *normal*, distributions and circuit designers can leverage this information to guardband their system, even when there is not a minimum or maximum specification in Section 7.6.

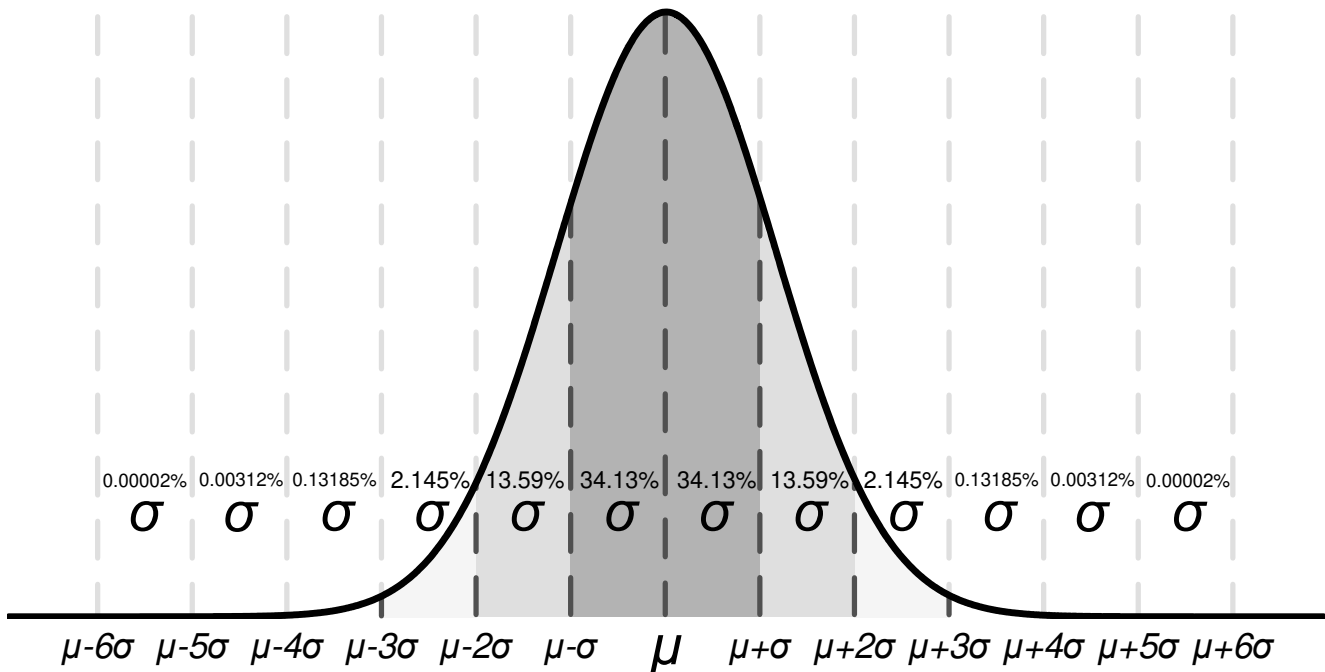

Figure 8-4. Ideal Gaussian Distribution

Figure 8-4 shows an example distribution, where μ , or *mu*, is the mean of the distribution, and where σ , or *sigma*, is the standard deviation of a system. For a specification that exhibits this kind of distribution, approximately two-thirds (68.26%) of all units can be expected to have a value within one standard deviation, or one sigma, of the mean (from $\mu - \sigma$ to $\mu + \sigma$).

Depending on the specification, values listed in the *typical* column of Section 7.6 are represented in different ways. As a general rule of thumb, if a specification naturally has a nonzero mean (for example, like gain bandwidth), then the typical value is equal to the mean (μ). However, if a specification naturally has a mean near

zero (like input offset voltage), then the typical value is equal to the mean plus one standard deviation ($\mu + \sigma$) in order to most accurately represent the typical value.

You can use this chart to calculate approximate probability of a specification in a unit; for example, for OPA2375, the typical input voltage offset is 150 μV , so 68.2% of all OPA2375 devices are expected to have an offset from $-150 \mu\text{V}$ to 150 μV .

Specifications with a value in the minimum or maximum column are assured by TI, and units outside these limits will be removed from production material. For example, the OPA2375 device has a maximum offset voltage of 0.5 mV at 25°C, and even though this corresponds to 5 σ (≈ 1 in 1.7 million units), which is extremely unlikely, TI assures that any unit with a larger offset than 0.5 mV will be removed from production material.

For specifications with no value in the minimum or maximum column, consider selecting a sigma value of sufficient guardband for your application, and design worst-case conditions using this value. For example, the 6- σ value corresponds to about 1 in 500 million units, which is an extremely unlikely chance, and could be an option as a wide guardband to design a system around. In this case, the OPA2375 does not have a maximum or minimum for offset voltage drift, but based on [Figure 7-40](#) and the typical value of 0.16 $\mu\text{V}/^\circ\text{C}$ in [Section 7.6](#), it can be calculated that the 6- σ value for offset voltage drift is about 0.96 $\mu\text{V}/^\circ\text{C}$. When designing for worst-case system conditions, this value can be used to estimate the worst possible offset across temperature without having an actual minimum or maximum value.

However, process variation and adjustments over time can shift typical means and standard deviations, and unless there is a value in the minimum or maximum specification column, TI cannot assure the performance of a device. This information should be used only to estimate the performance of a device.

8.3.7 Shutdown Function

The OPAx375S devices feature $\overline{\text{SHDN}}$ pins that disable the op amp, placing it into a low-power standby mode. In this mode, the op amp typically consumes less than 1 μA . The $\overline{\text{SHDN}}$ pins are active-low, meaning that shutdown mode is enabled when the input to the $\overline{\text{SHDN}}$ pin is a valid logic low.

The $\overline{\text{SHDN}}$ pins are referenced to the negative supply voltage of the op amp. The threshold of the shutdown feature lies around 800 mV (typical) above the negative rail. Hysteresis has been included in the switching threshold to ensure smooth switching characteristics. To ensure optimal shutdown behavior, the $\overline{\text{SHDN}}$ pins should be driven with valid logic signals. A valid logic low is defined as a voltage between V_- and $V_- + 0.2 \text{ V}$. A valid logic high is defined as a voltage between $V_- + 1.2 \text{ V}$ and V_+ . The shutdown pin must either be connected to a valid high or a low voltage or driven, and not left as an open circuit. There is **no** internal pull-up to enable the amplifier.

The $\overline{\text{SHDN}}$ pins are high-impedance CMOS inputs. Dual op amp versions are independently controlled, and quad op amp versions are controlled in pairs with logic inputs. For battery-operated applications, this feature may be used to greatly reduce the average current and extend battery life. The enable time is 15 μs for full shutdown of all channels; disable time is 3 μs . When disabled, the output assumes a high-impedance state. This architecture allows the OPAx375S to be operated as a gated amplifier (or to have the device output multiplexed onto a common analog output bus). Shutdown time (t_{OFF}) depends on loading conditions and increases as load resistance increases. To ensure shutdown (disable) within a specific shutdown time, the specified 10-k Ω load to midsupply ($V_S / 2$) is required. If using the OPAx375S without a load, the resulting turnoff time is significantly increased.

8.3.8 Packages With an Exposed Thermal Pad

The OPAx375 family is available in packages such as the WSON-8 (DSG) which feature an exposed thermal pad. Inside the package, the die is attached to this thermal pad using an electrically conductive compound. For this reason, when using a package with an exposed thermal pad, the thermal pad must either be connected to V_- or left floating. Attaching the thermal pad to a potential other than V_- is not allowed, and performance of the device is not assured when doing so.

8.3.9 Common Mode Voltage Range

The input common-mode voltage range of the OPAx375 family extends to the negative rail and within 2 V of the top rail for normal operation. However, this device can also operate with full rail-to-rail input 100 mV beyond

the top rail, but with reduced performance within 2 V of the top rail. The typical performance in this range is summarized in for the OPA375. You can see the typical input offset voltage of the OPA2375/4375 in the [Figure 7-43](#) graph.

Table 8-2. OPA375 Typical Performance ($V_S = 5\text{ V}$, $V_{CM} > V_S - 1.2\text{ V}$)

PARAMETER	MIN	TYP	MAX	UNIT
Offset voltage		3		mV
Slew rate		1.5		V/ μ S
Input voltage noise density at f = 1 kHz		15		nV/ $\sqrt{\text{Hz}}$

8.4 Device Functional Modes

The OPAx375 family has a single functional mode. The OPA2375 and OPA4375 are powered on as long as the power-supply voltage is between 1.7 V ($\pm 0.85\text{ V}$) and 5.5 V ($\pm 2.75\text{ V}$). The OPA375 is powered on as long as the power-supply voltage is between 2.25 V ($\pm 1.125\text{ V}$) and 5.5 V ($\pm 2.75\text{ V}$).

9 Application and Implementation

Note

Information in the following applications sections is not part of the TI component specification, and TI does not warrant its accuracy or completeness. TI's customers are responsible for determining suitability of components for their purposes. Customers should validate and test their design implementation to confirm system functionality.

9.1 Application Information

The OPAx375 family features 10-MHz bandwidth and 4.75-V/ μ s slew rate with 890 μ A (OPA375), 990 μ A (OPA2375/4375) of supply current per channel, providing good AC performance at low-power consumption. DC applications are well served with a low input noise voltage of 3.5 nV/ $\sqrt{\text{Hz}}$ (OPA2375/4375), 3.7 nV/ $\sqrt{\text{Hz}}$ (OPA375) at 10 kHz, low input bias current, and a typical input offset voltage of 0.15 mV.

9.2 Single-Supply Electret Microphone Preamplifier With Speech Filter

Electret microphones are commonly used in portable electronics because of the small size, low cost, and relatively good signal-to-noise ratio (SNR). The small package size, low operating voltage and AC performance of the OPA375 make the device a viable option for preamplifier circuits for electret microphones. The circuit shown in [Figure 9-1](#) is a single-supply preamplifier circuit for electret microphones.

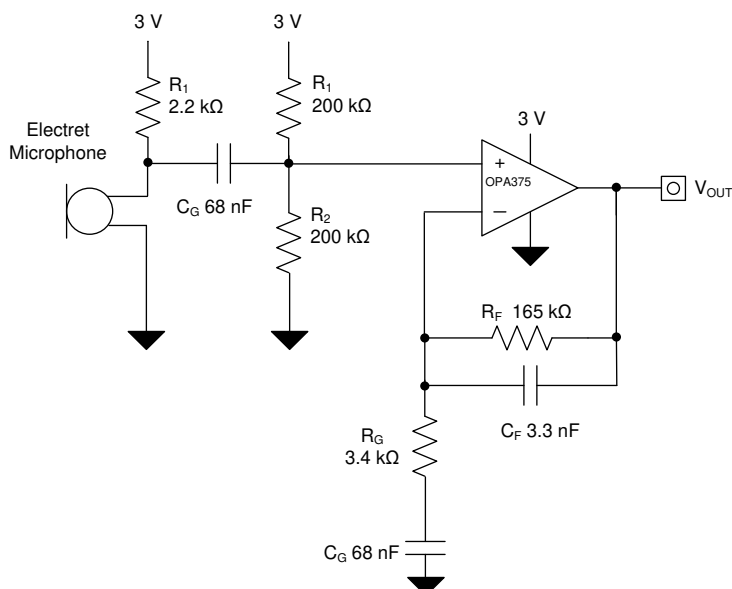

Copyright © 2017, Texas Instruments Incorporated

Figure 9-1. Microphone Preamplifier

9.2.1 Design Requirements

The design requirements are as follows:

- Supply voltage: 3 V
- Input voltage: 7.93 mV_{RMS} (0.63 Pa with a –38-dB SPL microphone)
- Output: 1 V_{RMS}
- Bandwidth: 300 Hz to 3 kHz

9.2.2 Detailed Design Procedure

The transfer function defining the relationship between V_{OUT} and the AC input signal is shown in [Equation 1](#).

$$V_{OUT} = V_{IN_AC} \times \left(1 + \frac{R_F}{R_G} \right) \quad (1)$$

The required gain can be calculated based on the expected input signal level and desired output level as shown in [Equation 2](#).

$$G_{OPA} = \frac{V_{OUT}}{V_{IN_AC}} = \frac{1V_{RMS}}{7.93mV_{RMS}} = 126 \frac{V}{V} \quad (2)$$

Select a standard 10-k Ω feedback resistor and calculate R_G from [Equation 3](#).

$$R_G = \frac{R_F}{G_{OPA} - 1} = \frac{10k\Omega}{126 \frac{V}{V} - 1} = 80\Omega \rightarrow 78.7\Omega \text{ (closest standard value)} \quad (3)$$

To minimize the attenuation in the desired passband from 300 Hz to 3 kHz, set the upper (f_H) and lower (f_L) cutoff frequencies outside of the desired bandwidth as:

$$f_L = 200 \text{ Hz} \quad (4)$$

and

$$f_H = 5 \text{ kHz} \quad (5)$$

Select C_G to set the f_L cutoff frequency using [Equation 6](#).

$$C_G = \frac{1}{2 \times \pi \times R_G \times f_L} = \frac{1}{2 \times \pi \times 78.7\Omega \times 200\text{Hz}} = 10.11\mu F \rightarrow 10\mu F \quad (6)$$

Select C_F to set the f_H cutoff frequency using [Equation 7](#).

$$C_F = \frac{1}{2 \times \pi \times R_F \times f_H} = \frac{1}{2 \times \pi \times 10k\Omega \times 5k\text{Hz}} = 3.18nF \rightarrow 3.3nF \text{ (Standard Value)} \quad (7)$$

The input signal cutoff frequency must be set low enough such that low-frequency sound waves still pass through. Therefore select C_{IN} to achieve a 30-Hz cutoff frequency (f_{IN}) using [Equation 8](#).

$$C_{IN} = \frac{1}{2 \times \pi \times (R_1 \parallel R_2) \times f_{IN}} = \frac{1}{2 \times \pi \times 100k\Omega \times 30\text{Hz}} = 53nF \rightarrow 68nF \text{ (Standard Value)} \quad (8)$$

The measured transfer function for the microphone preamplifier circuit is shown in [Figure 9-2](#) and the measured THD + N performance of the microphone preamplifier circuit is shown in [Figure 9-3](#).

9.2.3 Application Curves

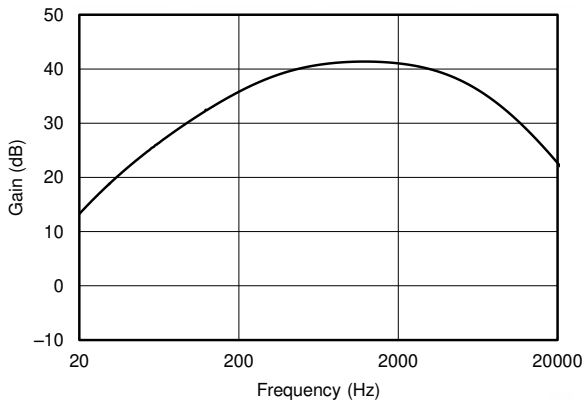

Figure 9-2. Gain vs Frequency

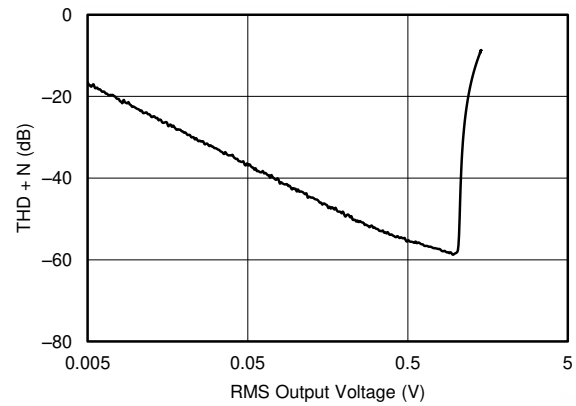

Figure 9-3. THD + N vs RMS Output Voltage

10 Power Supply Recommendations

The OPA2375 and OPA4375 devices are specified for operation from 1.7 V to 5.5 V (± 0.85 V to ± 2.75 V). The OPA375 device is specified for operation from 2.25 V to 5.5 V (± 1.125 V to ± 2.75 V). Many specifications of the OPAx375 family apply from -40°C to 125°C .

CAUTION

Supply voltages larger than 7 V can permanently damage the device (see [Section 7.1](#)).

Place 0.1- μF bypass capacitors close to the power-supply pins to reduce errors coupling in from noisy or high-impedance power supplies. For more detailed information on bypass capacitor placement, see [Section 11.1](#).

11 Layout

11.1 Layout Guidelines

For best operational performance of the device, use good printed-circuit board (PCB) layout practices, including:

- Noise can propagate into analog circuitry through the power pins of the circuit as a whole and the operational amplifier. Bypass capacitors are used to reduce the coupled noise by providing low-impedance power sources local to the analog circuitry.
 - Connect low-ESR, 0.1- μ F ceramic bypass capacitors between each supply pin and ground, placed as close to the device as possible. A single bypass capacitor from V+ to ground is applicable for single-supply applications.
- Separate grounding for analog and digital portions of the circuitry is one of the simplest and most effective methods of noise suppression. One or more layers on multilayer PCBs are usually devoted to ground planes. A ground plane helps distribute heat and reduces EMI noise pickup. Make sure to physically separate digital and analog grounds, paying attention to the flow of the ground current.
- To reduce parasitic coupling, run the input traces as far away from the supply or output traces as possible. If these traces cannot be kept separate, crossing the sensitive trace perpendicularly is much better than crossing in parallel with the noisy trace.
- Place the external components as close to the device as possible. Keeping RF and RG close to the inverting input minimizes parasitic capacitance, as shown in [Figure 11-1](#).
- Keep the length of input traces as short as possible. Always remember that the input traces are the most sensitive part of the circuit.
- Consider a driven, low-impedance guard ring around the critical traces. A guard ring can significantly reduce leakage currents from nearby traces that are at different potentials.

11.2 Layout Example

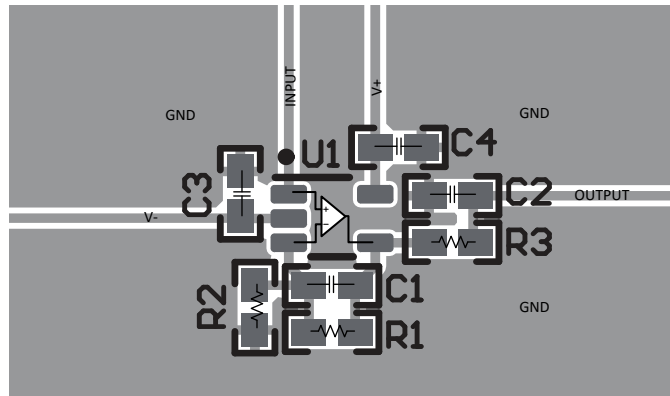
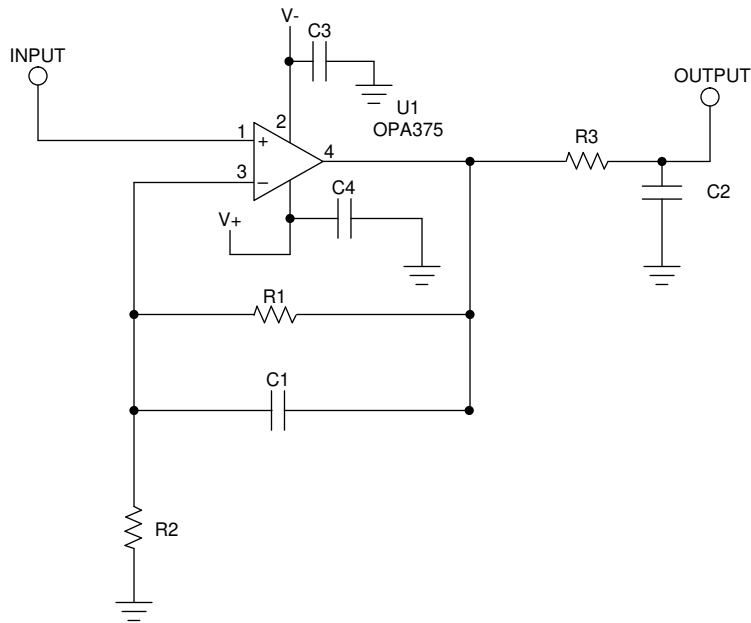

Figure 11-1. Operational Amplifier Board Layout for Noninverting Configuration



Copyright © 2017, Texas Instruments Incorporated

Figure 11-2. Layout Example Schematic



Figure 11-3. Example Layout for VSSOP-8 (DGK) Package

12 Device and Documentation Support

12.1 Documentation Support

12.1.1 Related Documentation

For related documentation see the following:

- Texas Instruments, [QFN/SON PCB Attachment](#)
- Texas Instruments, [Quad Flatpack No-Lead Logic Packages](#)
- Texas Instruments, [EMI Rejection Ratio of Operational Amplifiers](#)

12.2 Receiving Notification of Documentation Updates

To receive notification of documentation updates, navigate to the device product folder on [ti.com](#). Click on *Subscribe to updates* to register and receive a weekly digest of any product information that has changed. For change details, review the revision history included in any revised document.

12.3 Support Resources

[TI E2E™ support forums](#) are an engineer's go-to source for fast, verified answers and design help — straight from the experts. Search existing answers or ask your own question to get the quick design help you need.

Linked content is provided "AS IS" by the respective contributors. They do not constitute TI specifications and do not necessarily reflect TI's views; see TI's [Terms of Use](#).

12.4 Trademarks

TI E2E™ is a trademark of Texas Instruments.

Bluetooth® is a registered trademark of Bluetooth SIG, Inc.

All trademarks are the property of their respective owners.

12.5 Electrostatic Discharge Caution



This integrated circuit can be damaged by ESD. Texas Instruments recommends that all integrated circuits be handled with appropriate precautions. Failure to observe proper handling and installation procedures can cause damage.

ESD damage can range from subtle performance degradation to complete device failure. Precision integrated circuits may be more susceptible to damage because very small parametric changes could cause the device not to meet its published specifications.

12.6 Glossary

[TI Glossary](#) This glossary lists and explains terms, acronyms, and definitions.

13 Mechanical, Packaging, and Orderable Information

The following pages include mechanical, packaging, and orderable information. This information is the most current data available for the designated devices. This data is subject to change without notice and revision of this document. For browser-based versions of this data sheet, refer to the left-hand navigation.

PACKAGING INFORMATION

Orderable Device	Status (1)	Package Type	Package Drawing	Pins	Package Qty	Eco Plan (2)	Lead finish/ Ball material (6)	MSL Peak Temp (3)	Op Temp (°C)	Device Marking (4/5)	Samples
OPA2375IDDFR	ACTIVE	SOT-23-THIN	DDF	8	3000	RoHS & Green	NIPDAU	Level-1-260C-UNLIM	-40 to 125	O75D	Samples
OPA2375IDGKR	ACTIVE	VSSOP	DGK	8	2500	RoHS & Green	SN	Level-1-260C-UNLIM	-40 to 125	2J8T	Samples
OPA2375IDR	ACTIVE	SOIC	D	8	2500	RoHS & Green	NIPDAU	Level-2-260C-1 YEAR	-40 to 125	O2375D	Samples
OPA2375IDSGR	ACTIVE	WSON	DSG	8	3000	RoHS & Green	NIPDAU	Level-1-260C-UNLIM	-40 to 125	O75D	Samples
OPA2375IPWR	ACTIVE	TSSOP	PW	8	2000	RoHS & Green	NIPDAU	Level-2-260C-1 YEAR	-40 to 125	O2375P	Samples
OPA2375SIRUGR	ACTIVE	X2QFN	RUG	10	3000	RoHS & Green	NIPDAUAG	Level-2-260C-1 YEAR	-40 to 125	HIF	Samples
OPA375IDCKR	ACTIVE	SC70	DCK	5	3000	RoHS & Green	NIPDAU	Level-2-260C-1 YEAR	-40 to 125	19W	Samples
OPA375IDCKT	ACTIVE	SC70	DCK	5	250	RoHS & Green	NIPDAU	Level-2-260C-1 YEAR	-40 to 125	19W	Samples

(1) The marketing status values are defined as follows:

ACTIVE: Product device recommended for new designs.

LIFEBUY: TI has announced that the device will be discontinued, and a lifetime-buy period is in effect.

NRND: Not recommended for new designs. Device is in production to support existing customers, but TI does not recommend using this part in a new design.

PREVIEW: Device has been announced but is not in production. Samples may or may not be available.

OBSOLETE: TI has discontinued the production of the device.

(2) **RoHS:** TI defines "RoHS" to mean semiconductor products that are compliant with the current EU RoHS requirements for all 10 RoHS substances, including the requirement that RoHS substance do not exceed 0.1% by weight in homogeneous materials. Where designed to be soldered at high temperatures, "RoHS" products are suitable for use in specified lead-free processes. TI may reference these types of products as "Pb-Free".

RoHS Exempt: TI defines "RoHS Exempt" to mean products that contain lead but are compliant with EU RoHS pursuant to a specific EU RoHS exemption.

Green: TI defines "Green" to mean the content of Chlorine (Cl) and Bromine (Br) based flame retardants meet JS709B low halogen requirements of <=1000ppm threshold. Antimony trioxide based flame retardants must also meet the <=1000ppm threshold requirement.

(3) MSL, Peak Temp. - The Moisture Sensitivity Level rating according to the JEDEC industry standard classifications, and peak solder temperature.

(4) There may be additional marking, which relates to the logo, the lot trace code information, or the environmental category on the device.

(5) Multiple Device Markings will be inside parentheses. Only one Device Marking contained in parentheses and separated by a "~" will appear on a device. If a line is indented then it is a continuation of the previous line and the two combined represent the entire Device Marking for that device.

⁽⁶⁾ Lead finish/Ball material - Orderable Devices may have multiple material finish options. Finish options are separated by a vertical ruled line. Lead finish/Ball material values may wrap to two lines if the finish value exceeds the maximum column width.

Important Information and Disclaimer: The information provided on this page represents TI's knowledge and belief as of the date that it is provided. TI bases its knowledge and belief on information provided by third parties, and makes no representation or warranty as to the accuracy of such information. Efforts are underway to better integrate information from third parties. TI has taken and continues to take reasonable steps to provide representative and accurate information but may not have conducted destructive testing or chemical analysis on incoming materials and chemicals. TI and TI suppliers consider certain information to be proprietary, and thus CAS numbers and other limited information may not be available for release.

In no event shall TI's liability arising out of such information exceed the total purchase price of the TI part(s) at issue in this document sold by TI to Customer on an annual basis.

TAPE AND REEL INFORMATION



QUADRANT ASSIGNMENTS FOR PIN 1 ORIENTATION IN TAPE



*All dimensions are nominal

Device	Package Type	Package Drawing	Pins	SPQ	Reel Diameter (mm)	Reel Width W1 (mm)	A0 (mm)	B0 (mm)	K0 (mm)	P1 (mm)	W (mm)	Pin1 Quadrant
OPA2375IDDFR	SOT-23-THIN	DDF	8	3000	180.0	8.4	3.2	3.2	1.4	4.0	8.0	Q3
OPA2375IDGKR	VSSOP	DGK	8	2500	330.0	12.4	5.3	3.4	1.4	8.0	12.0	Q1
OPA2375IDR	SOIC	D	8	2500	330.0	12.4	6.4	5.2	2.1	8.0	12.0	Q1
OPA2375IDSGR	WSOP	DSG	8	3000	180.0	8.4	2.3	2.3	1.15	4.0	8.0	Q2
OPA2375IPWR	TSSOP	PW	8	2000	330.0	12.4	7.0	3.6	1.6	8.0	12.0	Q1
OPA2375SIRUGR	X2QFN	RUG	10	3000	178.0	8.4	1.75	2.25	0.56	4.0	8.0	Q1
OPA375IDCKR	SC70	DCK	5	3000	178.0	9.0	2.4	2.5	1.2	4.0	8.0	Q3
OPA375IDCKT	SC70	DCK	5	250	178.0	9.0	2.4	2.5	1.2	4.0	8.0	Q3

TAPE AND REEL BOX DIMENSIONS

*All dimensions are nominal

Device	Package Type	Package Drawing	Pins	SPQ	Length (mm)	Width (mm)	Height (mm)
OPA2375IDDFR	SOT-23-THIN	DDF	8	3000	210.0	185.0	35.0
OPA2375IDGKR	VSSOP	DGK	8	2500	366.0	364.0	50.0
OPA2375IDR	SOIC	D	8	2500	356.0	356.0	35.0
OPA2375IDSGR	WSON	DSG	8	3000	210.0	185.0	35.0
OPA2375IPWR	TSSOP	PW	8	2000	356.0	356.0	35.0
OPA2375SIRUGR	X2QFN	RUG	10	3000	205.0	200.0	33.0
OPA375IDCKR	SC70	DCK	5	3000	190.0	190.0	30.0
OPA375IDCKT	SC70	DCK	5	250	190.0	190.0	30.0

DCK0005A



PACKAGE OUTLINE

SOT - 1.1 max height

SMALL OUTLINE TRANSISTOR



4214834/C 03/2023

NOTES:

1. All linear dimensions are in millimeters. Any dimensions in parenthesis are for reference only. Dimensioning and tolerancing per ASME Y14.5M.
2. This drawing is subject to change without notice.
3. Reference JEDEC MO-203.
4. Support pin may differ or may not be present.

EXAMPLE BOARD LAYOUT

DCK0005A

SOT - 1.1 max height

SMALL OUTLINE TRANSISTOR

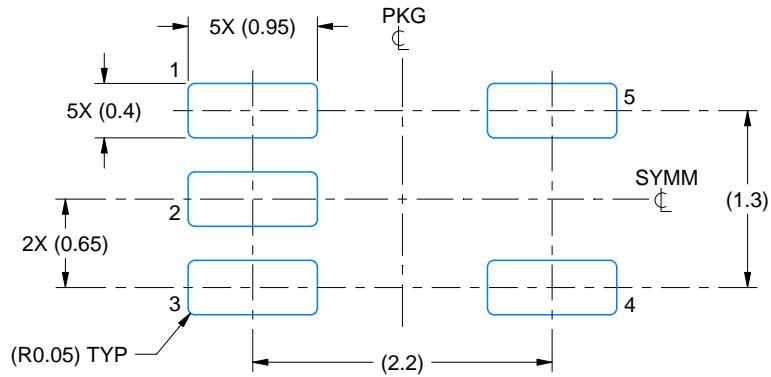

LAND PATTERN EXAMPLE
EXPOSED METAL SHOWN
SCALE:18X



SOLDER MASK DETAILS

4214834/C 03/2023

NOTES: (continued)

- 4. Publication IPC-7351 may have alternate designs.
- 5. Solder mask tolerances between and around signal pads can vary based on board fabrication site.

EXAMPLE STENCIL DESIGN

DCK0005A

SOT - 1.1 max height

SMALL OUTLINE TRANSISTOR



SOLDER PASTE EXAMPLE
BASED ON 0.125 THICK STENCIL
SCALE:18X

4214834/C 03/2023

NOTES: (continued)

6. Laser cutting apertures with trapezoidal walls and rounded corners may offer better paste release. IPC-7525 may have alternate design recommendations.
7. Board assembly site may have different recommendations for stencil design.

DDF0008A



PACKAGE OUTLINE

SOT-23 - 1.1 mm max height

PLASTIC SMALL OUTLINE



NOTES:

- All linear dimensions are in millimeters. Any dimensions in parenthesis are for reference only. Dimensioning and tolerancing per ASME Y14.5M.
- This drawing is subject to change without notice.
- This dimension does not include mold flash, protrusions, or gate burrs. Mold flash, protrusions, or gate burrs shall not exceed 0.15 mm per side.

EXAMPLE BOARD LAYOUT

DDF0008A

SOT-23 - 1.1 mm max height

PLASTIC SMALL OUTLINE

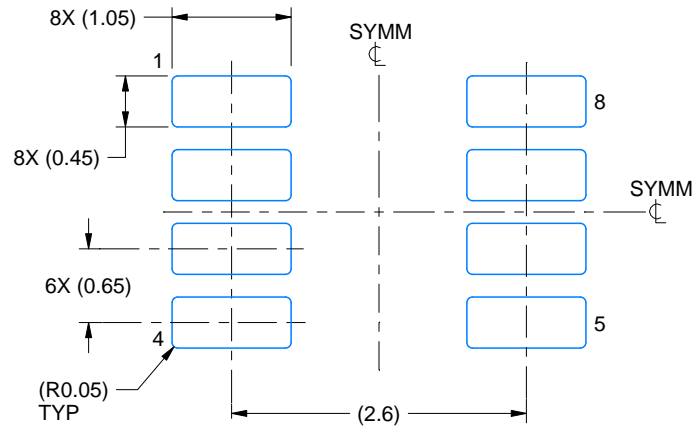

LAND PATTERN EXAMPLE
SCALE:15X

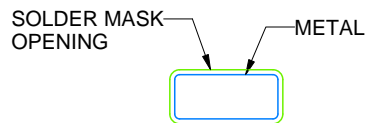

NON SOLDER MASK
DEFINED



SOLDER MASK
DEFINED

SOLDER MASK DETAILS

4222047/C 10/2022

NOTES: (continued)

4. Publication IPC-7351 may have alternate designs.
5. Solder mask tolerances between and around signal pads can vary based on board fabrication site.

EXAMPLE STENCIL DESIGN

DDF0008A

SOT-23 - 1.1 mm max height

PLASTIC SMALL OUTLINE



SOLDER PASTE EXAMPLE
BASED ON 0.125 mm THICK STENCIL
SCALE:15X

4222047/C 10/2022

NOTES: (continued)

6. Laser cutting apertures with trapezoidal walls and rounded corners may offer better paste release. IPC-7525 may have alternate design recommendations.
7. Board assembly site may have different recommendations for stencil design.

RUG (R-PQFP-N10)

PLASTIC QUAD FLATPACK

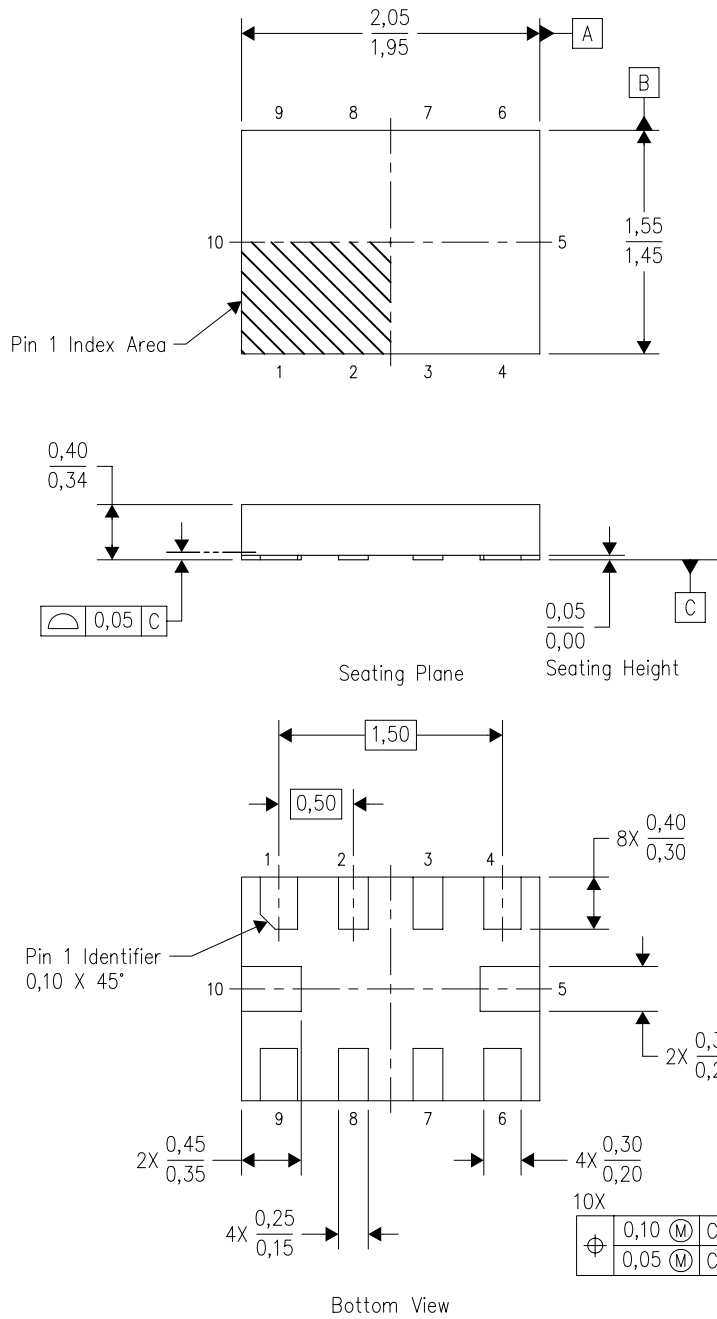

4208528-3/B 04/2008

- NOTES:
- A. All linear dimensions are in millimeters. Dimensioning and tolerancing per ASME Y14.5M-1994.
 - B. This drawing is subject to change without notice.
 - C. QFN (Quad Flatpack No-Lead) package configuration.
 - D. This package complies to JEDEC MO-288 variation X2EFD.

RUG (R-PQFP-N10)

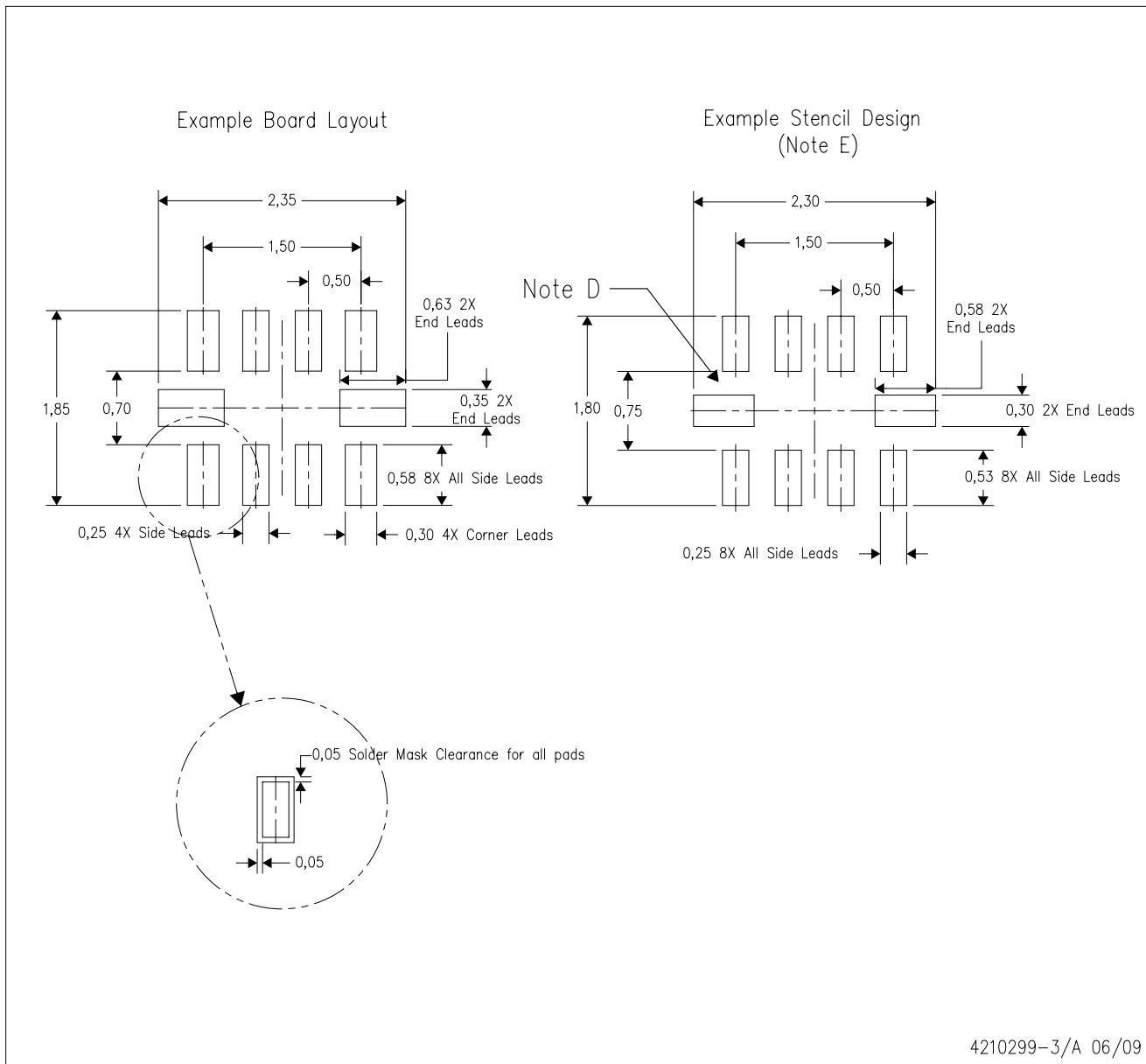

4210299-3/A 06/09

- NOTES:
- A. All linear dimensions are in millimeters.
 - B. This drawing is subject to change without notice.
 - C. Publication IPC-7351 is recommended for alternate designs.
 - D. Customers should contact their board fabrication site for minimum solder mask web tolerances between signal pads.
 - E. Maximum stencil thickness 0,127 mm (5 mils). All linear dimensions are in millimeters.
 - F. Laser cutting apertures with trapezoidal walls and also rounding corners will offer better paste release. Customers should contact their board assembly site for stencil design recommendations. Refer to IPC 7525 for stencil design considerations.
 - G. Side aperture dimensions over-print land for acceptable area ratio > 0.66. Customer may reduce side aperture dimensions if stencil manufacturing process allows for sufficient release at smaller opening.



D0008A

PACKAGE OUTLINE

SOIC - 1.75 mm max height

SMALL OUTLINE INTEGRATED CIRCUIT



4214825/C 02/2019

NOTES:

- Linear dimensions are in inches [millimeters]. Dimensions in parenthesis are for reference only. Controlling dimensions are in inches. Dimensioning and tolerancing per ASME Y14.5M.
- This drawing is subject to change without notice.
- This dimension does not include mold flash, protrusions, or gate burrs. Mold flash, protrusions, or gate burrs shall not exceed $.006$ [0.15] per side.
- This dimension does not include interlead flash.
- Reference JEDEC registration MS-012, variation AA.

EXAMPLE BOARD LAYOUT

D0008A

SOIC - 1.75 mm max height

SMALL OUTLINE INTEGRATED CIRCUIT



LAND PATTERN EXAMPLE
 EXPOSED METAL SHOWN
 SCALE:8X



SOLDER MASK DETAILS

4214825/C 02/2019

NOTES: (continued)

- 6. Publication IPC-7351 may have alternate designs.
- 7. Solder mask tolerances between and around signal pads can vary based on board fabrication site.

EXAMPLE STENCIL DESIGN

D0008A

SOIC - 1.75 mm max height

SMALL OUTLINE INTEGRATED CIRCUIT



SOLDER PASTE EXAMPLE
BASED ON .005 INCH [0.125 MM] THICK STENCIL
SCALE:8X

4214825/C 02/2019

NOTES: (continued)

8. Laser cutting apertures with trapezoidal walls and rounded corners may offer better paste release. IPC-7525 may have alternate design recommendations.
9. Board assembly site may have different recommendations for stencil design.

DGK (S-PDSO-G8)

PLASTIC SMALL-OUTLINE PACKAGE



- NOTES:
- A. All linear dimensions are in millimeters.
 - B. This drawing is subject to change without notice.
 - C. Body length does not include mold flash, protrusions, or gate burrs. Mold flash, protrusions, or gate burrs shall not exceed 0.15 per end.
 - D. Body width does not include interlead flash. Interlead flash shall not exceed 0.50 per side.
 - E. Falls within JEDEC MO-187 variation AA, except interlead flash.



- NOTES:
- A. All linear dimensions are in millimeters.
 - B. This drawing is subject to change without notice.
 - C. Publication IPC-7351 is recommended for alternate designs.
 - D. Laser cutting apertures with trapezoidal walls and also rounding corners will offer better paste release. Customers should contact their board assembly site for stencil design recommendations. Refer to IPC-7525 for other stencil recommendations.
 - E. Customers should contact their board fabrication site for solder mask tolerances between and around signal pads.

GENERIC PACKAGE VIEW

DSG 8

WSON - 0.8 mm max height

2 x 2, 0.5 mm pitch

PLASTIC SMALL OUTLINE - NO LEAD

This image is a representation of the package family, actual package may vary.
Refer to the product data sheet for package details.



4224783/A



ALTERNATIVE TERMINAL SHAPE TYPICAL



SIDE WALL METAL THICKNESS DIM A	
OPTION 1	OPTION 2
0.1	0.2

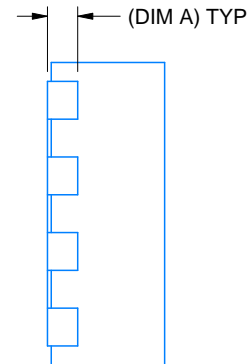

4218900/E 08/2022

NOTES:

1. All linear dimensions are in millimeters. Any dimensions in parenthesis are for reference only. Dimensioning and tolerancing per ASME Y14.5M.
2. This drawing is subject to change without notice.
3. The package thermal pad must be soldered to the printed circuit board for thermal and mechanical performance.

EXAMPLE BOARD LAYOUT

DSG0008A

WSON - 0.8 mm max height

PLASTIC SMALL OUTLINE - NO LEAD



LAND PATTERN EXAMPLE
SCALE:20X



SOLDER MASK DETAILS

4218900/E 08/2022

NOTES: (continued)

4. This package is designed to be soldered to a thermal pad on the board. For more information, see Texas Instruments literature number SLUA271 (www.ti.com/lit/slua271).
5. Vias are optional depending on application, refer to device data sheet. If any vias are implemented, refer to their locations shown on this view. It is recommended that vias under paste be filled, plugged or tented.

EXAMPLE STENCIL DESIGN

DSG0008A

WSON - 0.8 mm max height

PLASTIC SMALL OUTLINE - NO LEAD



SOLDER PASTE EXAMPLE
BASED ON 0.125 mm THICK STENCIL

EXPOSED PAD 9:
87% PRINTED SOLDER COVERAGE BY AREA UNDER PACKAGE
SCALE:25X

4218900/E 08/2022

NOTES: (continued)

6. Laser cutting apertures with trapezoidal walls and rounded corners may offer better paste release. IPC-7525 may have alternate design recommendations.

PW0008A



PACKAGE OUTLINE

TSSOP - 1.2 mm max height

SMALL OUTLINE PACKAGE



4221848/A 02/2015

NOTES:

- All linear dimensions are in millimeters. Any dimensions in parenthesis are for reference only. Dimensioning and tolerancing per ASME Y14.5M.
- This drawing is subject to change without notice.
- This dimension does not include mold flash, protrusions, or gate burrs. Mold flash, protrusions, or gate burrs shall not exceed 0.15 mm per side.
- This dimension does not include interlead flash. Interlead flash shall not exceed 0.25 mm per side.
- Reference JEDEC registration MO-153, variation AA.

EXAMPLE BOARD LAYOUT

PW0008A

TSSOP - 1.2 mm max height

SMALL OUTLINE PACKAGE



LAND PATTERN EXAMPLE
SCALE:10X



SOLDER MASK DETAILS
NOT TO SCALE

4221848/A 02/2015

NOTES: (continued)

- 6. Publication IPC-7351 may have alternate designs.
- 7. Solder mask tolerances between and around signal pads can vary based on board fabrication site.

EXAMPLE STENCIL DESIGN

PW0008A

TSSOP - 1.2 mm max height

SMALL OUTLINE PACKAGE



SOLDER PASTE EXAMPLE
BASED ON 0.125 mm THICK STENCIL
SCALE:10X

4221848/A 02/2015

NOTES: (continued)

8. Laser cutting apertures with trapezoidal walls and rounded corners may offer better paste release. IPC-7525 may have alternate design recommendations.
9. Board assembly site may have different recommendations for stencil design.

IMPORTANT NOTICE AND DISCLAIMER

TI PROVIDES TECHNICAL AND RELIABILITY DATA (INCLUDING DATA SHEETS), DESIGN RESOURCES (INCLUDING REFERENCE DESIGNS), APPLICATION OR OTHER DESIGN ADVICE, WEB TOOLS, SAFETY INFORMATION, AND OTHER RESOURCES "AS IS" AND WITH ALL FAULTS, AND DISCLAIMS ALL WARRANTIES, EXPRESS AND IMPLIED, INCLUDING WITHOUT LIMITATION ANY IMPLIED WARRANTIES OF MERCHANTABILITY, FITNESS FOR A PARTICULAR PURPOSE OR NON-INFRINGEMENT OF THIRD PARTY INTELLECTUAL PROPERTY RIGHTS.

These resources are intended for skilled developers designing with TI products. You are solely responsible for (1) selecting the appropriate TI products for your application, (2) designing, validating and testing your application, and (3) ensuring your application meets applicable standards, and any other safety, security, regulatory or other requirements.

These resources are subject to change without notice. TI grants you permission to use these resources only for development of an application that uses the TI products described in the resource. Other reproduction and display of these resources is prohibited. No license is granted to any other TI intellectual property right or to any third party intellectual property right. TI disclaims responsibility for, and you will fully indemnify TI and its representatives against, any claims, damages, costs, losses, and liabilities arising out of your use of these resources.

TI's products are provided subject to [TI's Terms of Sale](#) or other applicable terms available either on [ti.com](https://www.ti.com) or provided in conjunction with such TI products. TI's provision of these resources does not expand or otherwise alter TI's applicable warranties or warranty disclaimers for TI products.

TI objects to and rejects any additional or different terms you may have proposed.

Mailing Address: Texas Instruments, Post Office Box 655303, Dallas, Texas 75265
Copyright © 2023, Texas Instruments Incorporated