

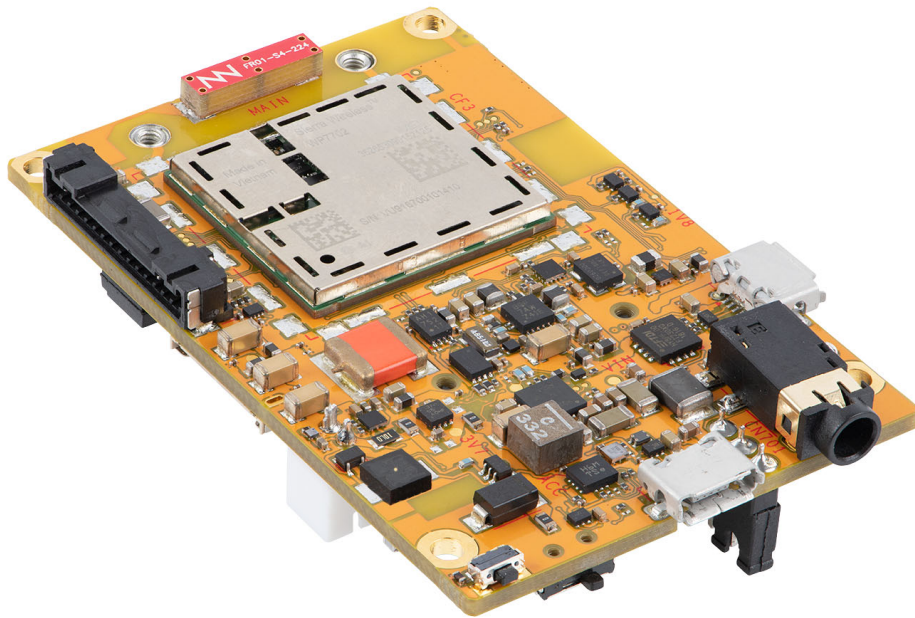

mangOH Yellow

Getting Started Guide



41113347
Rev 4
Contents subject to change

Important Notice

Due to the nature of wireless communications, transmission and reception of data can never be guaranteed. Data may be delayed, corrupted (i.e., have errors) or be totally lost. Although significant delays or losses of data are rare when wireless devices such as the Sierra Wireless modem are used in a normal manner with a well-constructed network, the Sierra Wireless modem should not be used in situations where failure to transmit or receive data could result in damage of any kind to the user or any other party, including but not limited to personal injury, death, or loss of property. Sierra Wireless accepts no responsibility for damages of any kind resulting from delays or errors in data transmitted or received using the Sierra Wireless modem, or for failure of the Sierra Wireless modem to transmit or receive such data.

Limitation of Liability

The information in this manual is subject to change without notice and does not represent a commitment on the part of Sierra Wireless. SIERRA WIRELESS AND ITS AFFILIATES SPECIFICALLY DISCLAIM LIABILITY FOR ANY AND ALL DIRECT, INDIRECT, SPECIAL, GENERAL, INCIDENTAL, CONSEQUENTIAL, PUNITIVE OR EXEMPLARY DAMAGES INCLUDING, BUT NOT LIMITED TO, LOSS OF PROFITS OR REVENUE OR ANTICIPATED PROFITS OR REVENUE ARISING OUT OF THE USE OR INABILITY TO USE ANY SIERRA WIRELESS PRODUCT, EVEN IF SIERRA WIRELESS AND/OR ITS AFFILIATES HAS BEEN ADVISED OF THE POSSIBILITY OF SUCH DAMAGES OR THEY ARE FORESEEABLE OR FOR CLAIMS BY ANY THIRD PARTY.

Notwithstanding the foregoing, in no event shall Sierra Wireless and/or its affiliates aggregate liability arising under or in connection with the Sierra Wireless product, regardless of the number of events, occurrences, or claims giving rise to liability, be in excess of the price paid by the purchaser for the Sierra Wireless product.

Patents

This product may contain technology developed by or for Sierra Wireless Inc.

This document contains information which is proprietary to Sierra Wireless Inc. and is licensed pursuant to Creative Commons Attribution 4.0 International License.

Document details

Title: mangOH Yellow Getting Started Guide

Author: Sierra Wireless

Source: <http://mangoh.io/>

Copyright

© May 11, 2020 Sierra Wireless. Licensed under the Creative Commons Attribution 4.0 license, <http://creativecommons.org/licenses/by/4.0/>



Disclaimer

Indicate any modifications made to the original document.

Trademarks

mangOH® and the mangOH logo are trademarks of Sierra Wireless.

Other trademarks are the property of their respective owners.

Revision History

Revision number	Release date	Changes
1	September 2019	Document created
2	October 2019	Updated figure callouts, reduced image sizes Updated description of LEDs Updated 3.3 (Windows only) Install CF3 Module Drivers Added note for 2G, battery required Updated Connect to Octave chapter Added appendix Install Leaf and Build mangOH Software
3	January 2020	Added Firmware Update appendix
4	May 2020	Added step to turn power switch on

Contents

- Get Started 5**

- Register a mangoh.io Account 6**

- Set Up Your mangOH Yellow 7**
 - Peel Your mangOH Yellow 7
 - Quick Components Overview 8
 - (Windows only) Install CF3 Module Drivers 9
 - Prepare Your mangOH Yellow 9

- Connect to Your mangOH Yellow 13**

- Connect to Octave 15**
 - Claim Your Free Trial Octave Account 15
 - Send Sensor Data to Octave 19
 - Affect mangOH Yellow Resources from Octave 22

- Install Leaf and Build mangOH Software 25**

- Updating the Firmware on a mangOH 28**

1: Get Started

Thanks for purchasing the mangOH[®] Yellow development kit! Use this guide to prepare your mangOH Yellow and computer for IoT development.

Table 1-1: Minimum System Requirements

O/S	<ul style="list-style-type: none"> Windows[®] 7 and higher (64-bit) Ubuntu 16.04 macOS[®]
CPU	Dual core @ 2.6 GHz
RAM	4 GB
HDD	10 GB free space
USB Ports	<ul style="list-style-type: none"> Preferred—2 (for full functionality) Minimum—1

When you are ready to begin, work straight through the rest of this guide:

- STEP 1: [Register a mangoh.io Account on page 6](#)
- STEP 2: [Set Up Your mangOH Yellow on page 7](#)
- STEP 3: [Connect to Your mangOH Yellow on page 13](#)
- STEP 4: [Connect to Octave on page 15](#)

And then to make the most of your mangOH Yellow ...



Visit mangoh.io/mangoh-yellow-resources for mangOH Yellow guides, tutorials, and more.



Visit forum.mangoh.io to participate in the mangOH community.

2: Register a mangoh.io Account

The mangOH ecosystem of products, tutorials, documentation and more is constantly evolving.

Please register for a mangoh.io account to:

- Get access to mangOH documentation
- Receive notices of new mangOH products, IoT cards, and project code samples
- Receive periodic device-specific notices
- Be automatically included for a chance to win IoT cards in periodic giveaways

If you already have an account, please log in and register your new device so we can provide you with news about your device.

To register for an account:

1. Go to <https://mangoh.io> and click **Register**.
2. Enter the requested data to create your account.

Note:

- *E-mail address*—This will be your mangOH account login.
- *Password*—8-29 characters (including at least 1 lowercase letter, 1 uppercase letter, and 1 number.)
- *IoT Applications*—Please let us know all the fields you are developing for so we can improve the mangOH ecosystem for you!

3. Click **Register**.

If all required fields are filled correctly, your account is created and you are logged in automatically.

Otherwise, the fields that must be updated are indicated. Fix them, re-enter the password fields, and click **Register** again.

4. Now that you're logged into your account, click **Device Registration**.
5. Select mangOH Yellow as your new mangOH type.
6. Click **Submit**. Your mangOH account is updated with your device type.



Now you're ready to
[Set Up Your mangOH Yellow on page 7.](#)

3: Set Up Your mangOH Yellow

3.1 Peel Your mangOH Yellow

Open your mangOH Yellow kit and make sure you have all the parts—the kit contains everything you need (and more!) to get started:

- (1) mangOH Yellow board with soldered-down WP7702 CF3 module.

Note: The module ships with pre-built software already installed!

- (2) micro-USB cables
- (1) Ultra Wide Band antenna (taoglas FXUB63)
- (1) Breakout board (IoT expansion card format)
- (2) M2 screws for IoT card installation

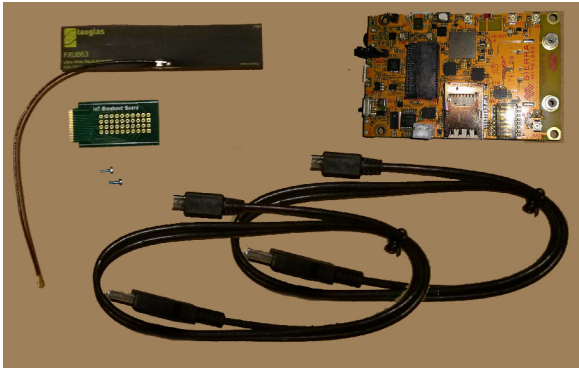

3.2 Quick Components Overview

Many components and connectors are already built into the mangOH Yellow. Some of these include:

Sensors and Outputs

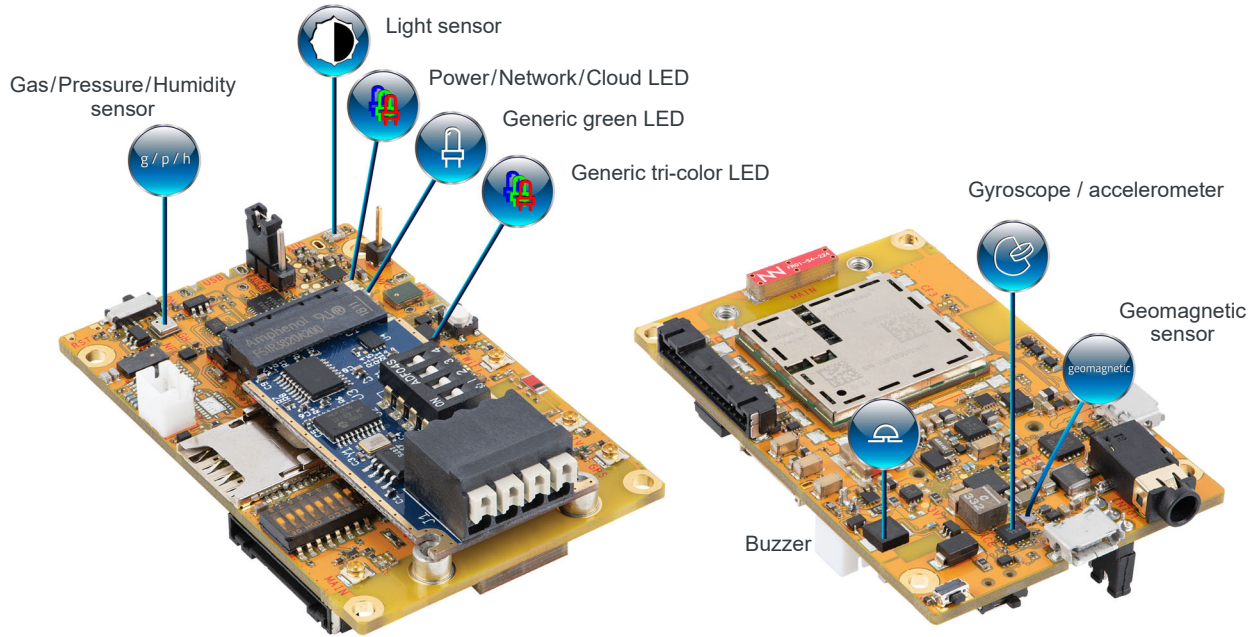

Modules and Power

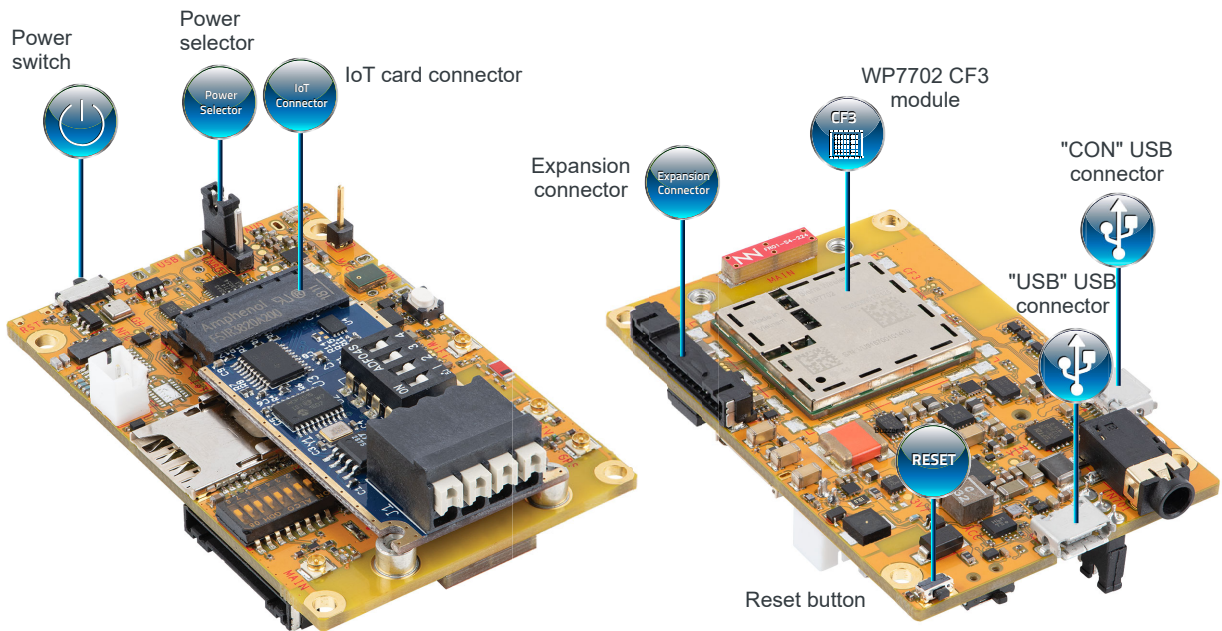

3.3 (Windows only) Install CF3 Module Drivers

Windows systems require drivers for the mangOH Yellow's CF3 module.

To download the drivers:

1. Go to <https://mangoh.io/mangoh-yellow-resources-software>.
2. Click **Download Drivers** to download the driver installation file.
3. Run the downloaded .exe file and follow the prompts to install the drivers.

3.4 Prepare Your mangOH Yellow

Your mangOH Yellow is (almost) ready to go right out of the box—all it needs is a power source:

1. Make sure the dip switches are set correctly:
 - a. Remove the protective film from the dip switch block:

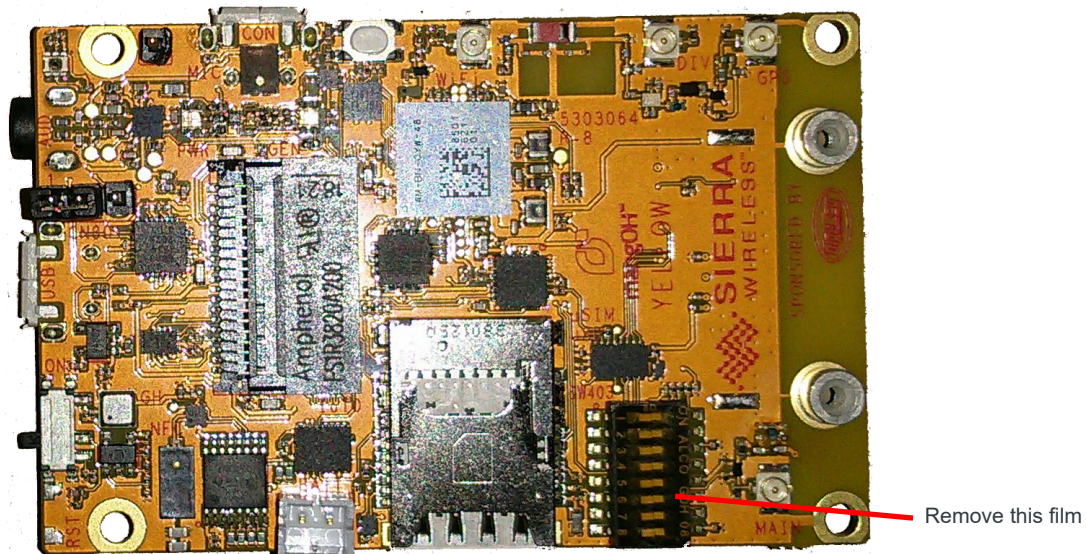

- b. Make sure all the dip switches are OFF (factory default mode).

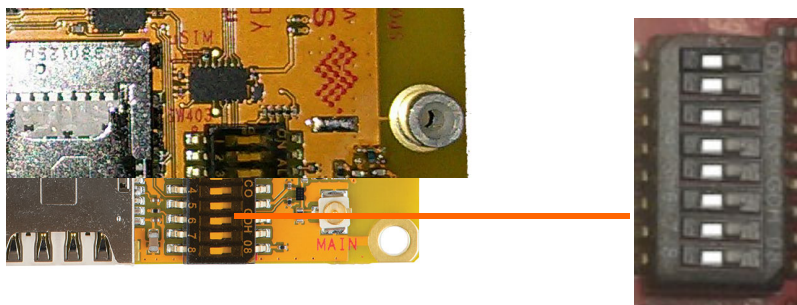

2. Make sure the power select jumper is on the pins closest to the edge of the board. (This selects the USB micro-B connector as the power supply.)

Note: The mangOH Yellow has two micro-B USB connectors:

- USB is used for SSH connections, AT commands, and firmware downloads.
 - CON is a serial connection used to access the module's console for diagnostic purposes.
-

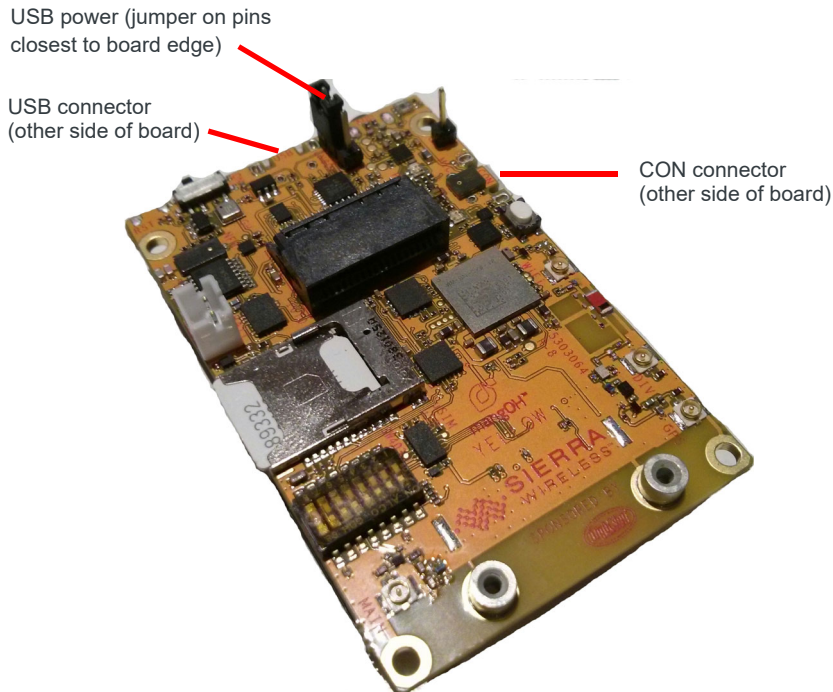

3. Power up the mangOH Yellow—Use a micro-USB cable to connect the USB connector to a powered USB port on your computer.

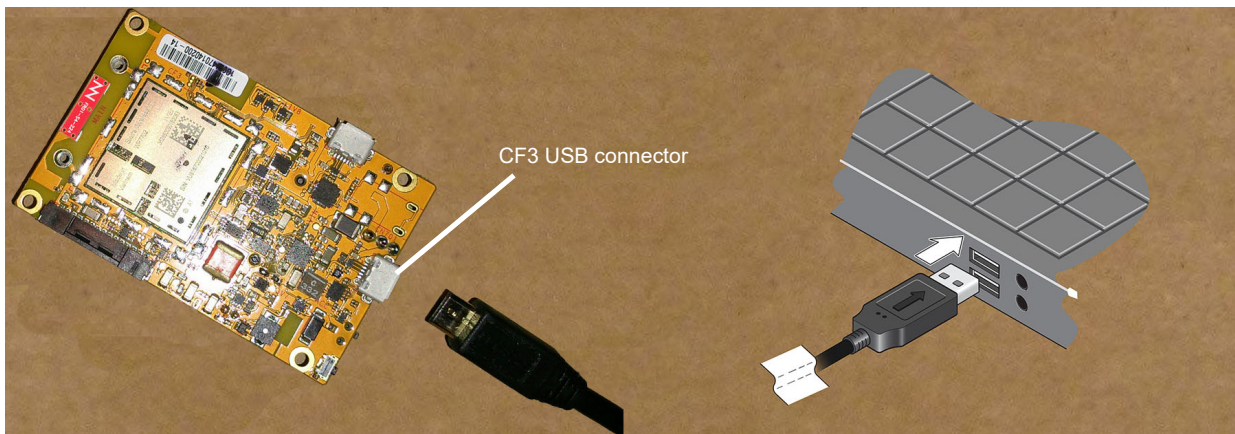

Important: If LTE-M coverage is not available, the mangOH Yellow's WP7702 module will fall back to 2G, which consumes up to 2 A of current for short bursts. In this case, USB power is insufficient (500 mA) and the module may repeatedly brown out and reboot. Use a Li-ion or Li-polymer (3.7 V nominal) battery to supply sufficient power. (See the mangOH Yellow User Guide for details.)

- Slide the power switch toward the center to power up the board.

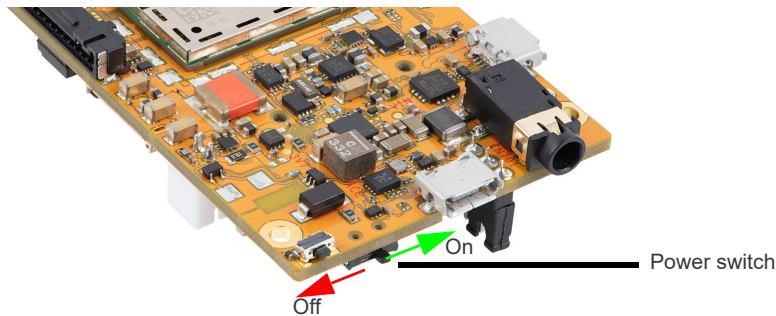

As soon as the mangOH Yellow is powered ...

- The Power/Network/Cloud LED turns green and the CF3 module begins to boot. The LED changes to yellow when the cellular radio powers on.
- The board's sensors turn on.
- A 'welcome' application (helloYellow) starts running to demonstrate some of the device inputs/outputs:
 - LED outputs—the board's generic LEDs start flashing in sequence to indicate the app is running.
 - Test the user button—Press the white user button. The buzzer sounds and the board's LEDs flash faster ('Vegas mode').

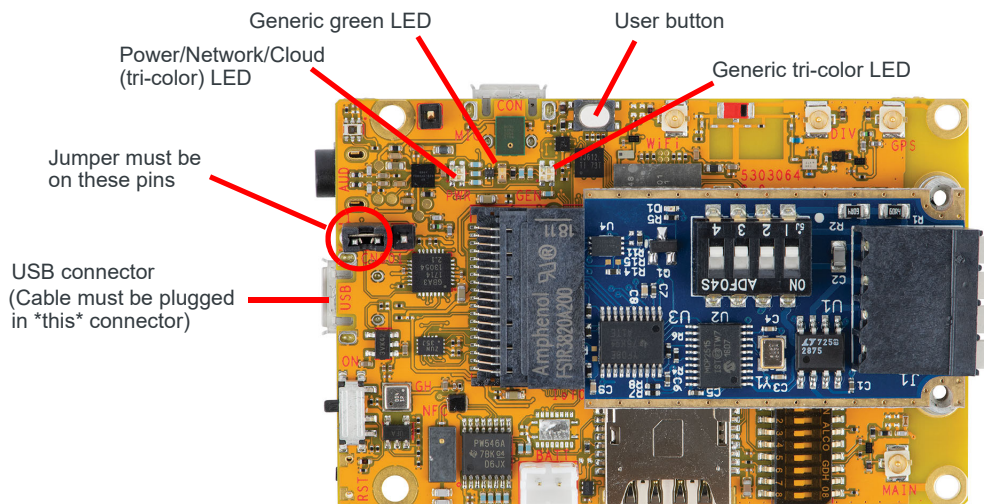

Tip: If the Power/Network/Cloud LED does not turn on:

- Make sure the USB cable is securely connected to the correct micro-B connector (as shown in the image).
- Make sure the jumper block is on the correct pins (as shown in the image).

Note: For future reference, the mangOH Yellow's power supply (USB port on your dev machine, or an AC adapter) connects to the board via either USB connector—USB or CON (depending on the jumper position on the power header). If an AC adapter is connected to USB, ssh/AT connections are not possible; if it is connected to CON, serial USB connections are not possible.



Now that you've peeled and prepared your mangOH, you can [Connect to Your mangOH Yellow on page 13](#).

4: Connect to Your mangOH Yellow

Now that your mangOH is powered on and running, connect to it to quickly test some of its features:

1. From your computer's command prompt, test the USB connection:

```
$ ping 192.168.2.2
```

You should receive ping responses by 'pinging' the CF3 module (which has a default IP address of 192.168.2.2). Press Ctrl+C to cancel the ping request and return to the command prompt.

```
$ ping 192.168.2.2
PING 192.168.2.2 (192.168.2.2) 56(84) bytes of data:
64 bytes from 192.168.2.2: icmp_seq=1 ttl=64 time=0.596 ms
64 bytes from 192.168.2.2: icmp_seq=1 ttl=64 time=0.518 ms
64 bytes from 192.168.2.2: icmp_seq=1 ttl=64 time=0.409 ms
64 bytes from 192.168.2.2: icmp_seq=1 ttl=64 time=0.648 ms
64 bytes from 192.168.2.2: icmp_seq=1 ttl=64 time=0.407 ms
^C
--- 192.168.2.2 ping statistics ---
5 packets transmitted, 5 received, 0% packet loss, time 2578ms
rtt min/avg/max/mdev = 0.407/0.516/0.648/0.100 ms
```

← Replies received, connection working

← Ctrl+C pressed to cancel ping

2. Connect to the mangOH Yellow using your terminal emulator:

```
$ ssh root@192.168.2.2
```

3. The following message appears if you are using your CF3 module for the first time (modules are shipped without a password).

```
It is strongly recommended to setup credentials for remote login.
Please select one of the following options:
 1) Setup ssh keys and disable passwords-based authentication via ssh
    (the most secure)
 2) Setup password (better than nothing)
 3) Do nothing
```

For now, type **3** and press Enter, then type **Y** and press Enter to be reminded the next time you connect. (During this tutorial, do this each time you open an SSH connection to the mangOH Red.)

Note: After completing this tutorial, you should select an appropriate login authentication method (ssh keys or password) from this menu—see docs.legato.io/latest/basicTarget.html for details.

4. Type `hello` to run the welcome application:

```
# hello

==== MAIN MENU ====

Welcome to mangOH Yellow!

Please make a selection from the following:

 1. DISABLE out-of-box experience
 2. LEDs
 3. Buzzer
 4. Octave

or press ESC to leave the screen or Q to quit.
```

Note: Your menu may look a bit different and show more/different options as new app versions are produced.

5. Choose any menu selection to test the mangOH Yellow features:
 - DISABLE out-of-box experience—When you are ready to work with Octave, select this option to disable 'Vegas mode'.
(The option changes to ENABLE out-of-box experience so you can turn Vegas mode back on again.)
 - LEDs—Follow the menu options to turn off and on the generic green LED and the generic tri-color LED, or to disable/enable Vegas mode.
 - Buzzer—Follow the menu options to set the period (length of time between beeps), the duty cycle percentage (beep length), and to test (activate/deactivate) the buzzer.
6. To return to the main "hello" menu, press Escape, or to return to the shell prompt, press Q.
7. To set up your Octave account in the next chapter, you need the serial number (FSN) and IMEI of your mangOH Yellow's CF3 module. To display your device information (including those fields), enter the following command:

```
# cm info
```

```
# cm info
Device: WP7702
IMEI: 352959095987162
IMEISV: 4
FSN: 41933959959959
Firmware Version: SWI9X06Y_02.32.02.00 c2e98c jenkins 2019/08/30 07:28:21
Bootloader Version: SWI9X06Y_02.32.02.00 c2e98c jenkins 2019/08/30 07:28:21
...
```

8. Type `exit` to close the ssh session.



Now that you've peeled and prepared your mangOH, you can [Connect to Octave on page 15](#) and see how the mangOH Yellow sends data to the cloud.

5: Connect to Octave

Now that your mangOH Yellow is working, it's time to send its sensor data to the cloud.

Your mangOH Yellow kit comes with a free 3-month trial subscription to Sierra Wireless' cloud-based Octave IoT platform, which can collect data from your mangOH Yellow, process it, and act on the data both in the cloud (on Octave) and 'at the edge' (on your mangOH).

5.1 Claim Your Free Trial Octave Account

Your Octave account is pre-configured with some basic options to experiment with collecting, processing, and taking actions based on your mangOH Yellow's sensor and other data.

To claim your free trial Octave account:

1. Go to octave.sierrawireless.io and click SIGNUP to create a "single sign on" Sierra Wireless account that will let you access Octave, as well as [the Source](#) and [the Forum](#).
2. Enter your information and click SIGN UP to create the account.
3. Follow the instructions that appear to complete your Sierra Wireless account activation. When complete, you will be logged in automatically and prompted to create your Octave account.
4. Enter the information to create your Octave account (click Next after filling each section, and click Confirm when finished).

The screenshot shows a web form titled "Create your Octave account". It is divided into four steps, with the first step, "Set your Octave user account", currently active. The form fields are as follows:

- Step 1: Set your Octave user account**
 - First name *: John
 - Last name *: Bbbbb
 - Username *: john_bbbbb
- Step 2: Set your Octave company**
- Step 3: Set your contact information**
- Step 4: Review the terms and conditions**

At the bottom of the form, there are two buttons: "PREVIOUS" (disabled) and "NEXT" (active).

Your Octave account information appears.

Create your Octave account

- 1 Set your Octave user account**
 - First name *
John
 - Last name *
Bbbbb
 - Username *
john_bbbbb
- 2 Set your Octave company
- 3 Set your contact information
- 4 Review the terms and conditions

PREVIOUS [NEXT](#)

When you finish creating your account, your Octave welcome screen appears.

5. Link your mangOH Yellow to your Octave account:
 - a. In the Already have a device? pane, click ACTIVATE A DEVICE.
 - b. Follow the instructions on-screen to activate your mangOH Yellow. (Click Next to move through the steps, and click Confirm when finished.)

Note:

- You are not required to enter payment information to claim the three-month free trial.
- Choose MangOH Yellow as the device model.
- The serial number is the device's FSN.

The screenshot displays the Octave web interface for activating a device. The sidebar on the left contains navigation links for DEVICE, CLOUD, DEPLOYMENT, MONITORING, and BILLING, along with links for Documentation, Forum, Master token, and Logout. The main content area is titled 'Activate a device' and features a progress bar with six steps. Step 1, 'Select the device model', is the current step, showing five device options: FX30, FX30S, MangOH Red, MangOH Yellow, and WP7702. The 'MangOH Yellow' option is selected, indicated by a hand cursor over its radio button. The other options have unselected radio buttons. Steps 2 through 6 are listed below step 1 but are not yet active. At the bottom of the main content area, there are 'PREVIOUS' and 'NEXT' buttons.

6. After confirming the activation, the Octave screen displays the Details pane showing an activation status message and device details.

Continue to [Send Sensor Data to Octave](#).

The screenshot displays the Octave web interface. The top navigation bar includes the Octave logo, the device name 'yellow_1_johnb', and the company name 'johnbbbb_company'. A left-hand sidebar menu is organized into sections: DEVICE (with sub-items: Details, Resources, Services, Observations, Edge Actions, Streams, Firmware, Blueprint), CLOUD (Develop in the cloud), DEPLOYMENT (Manage fleet), MONITORING (Monitor fleet), and BILLING (Billing Details). The main content area is titled 'Details' and features three panels: 'Identity' (Name: yellow_1_johnb, Path: /johnbbbb_company/devices/yellow_1_johnb, ID: d5da8bf6480a6480769ece22), 'Report' (Last seen: 1 day ago, Firmware version: 1.0, Current blueprint: None, Battery and Signal indicators, Messages generated: CALCULATE), and 'Hardware' (Model name: unknown, Module name: WP7702, Serial number: 4L933959959959, ICCID: 89592401000019595959, IMEI: 352959095987162).

5.2 Send Sensor Data to Octave

Tip: This guide demonstrates a small set of Octave's features. For more detailed Octave information, click the [Documentation link](#) near the bottom of the Octave menu.

When your mangOH Yellow is activated and powered on, it begins sending data from its sensors (Resources) to Octave.

To view the sensor data being sent to Octave:

1. In the Octave menu, click Details (if not already displayed).

The screenshot displays the Octave web interface for a device named 'yellow_1_johnb'. The left sidebar contains a navigation menu with 'Details' highlighted in red. The main content area shows the device's details, including its identity, report, hardware information, and recent events. The 'Recent events' section is also highlighted in red and shows a list of events with timestamps and JSON payloads.



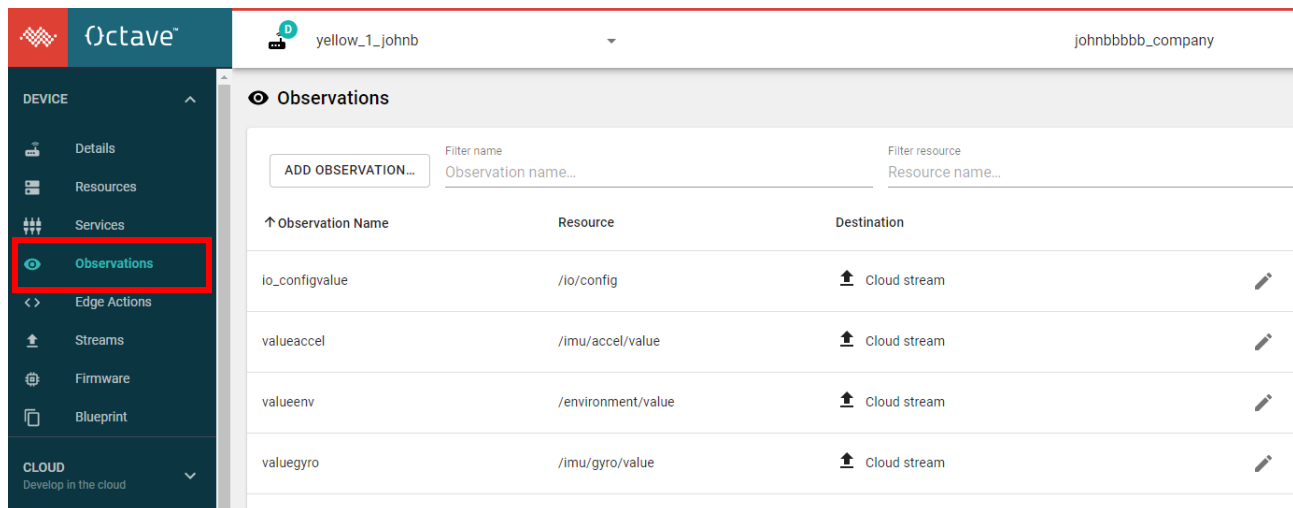

Event Type	Timestamp	JSON Payload
IMU	10:54:39 1	{ "imu": { "accel": { "x": ...
Environment	10:54:39 1	{ "environment": { "bre...
Environment	10:54:39 1	{ "environment": { "bre...
Action	10:53:34 18	{ "action": "POWER_ON" ...
Action	10:19:38 18	{ "action": "POWER_ON" ...
Action	10:07:47 18	{ "action": "POWER_ON" ...

The Recent Events section shows data sent from the mangOH Yellow.

2. In the Octave menu, click Observations.



The screenshot shows the Octave interface. The top bar includes the Octave logo, a user profile for 'yellow_1_johnb', and a company name 'johnbbbb_company'. The left sidebar is titled 'DEVICE' and contains several menu items: Details, Resources, Services, Observations (highlighted with a red box), Edge Actions, Streams, Firmware, and Blueprint. Below the sidebar is a 'CLOUD' section with the text 'Develop in the cloud'. The main content area is titled 'Observations' and features a table with the following data:

↑ Observation Name	Resource	Destination	
io_configvalue	/io/config	Cloud stream	
valueaccel	/imu/accel/value	Cloud stream	
valueenv	/environment/value	Cloud stream	
valuegyro	/imu/gyro/value	Cloud stream	

A list of pre-configured Observations appears, which are being reported in the Details screen's Recent Events.

Note: The observations shown above are an example only.

Note: To add your own observations later, refer to the Octave Documentation menu option for details.

- Each observation is initially configured as a 'Cloud stream'—the data is displayed in the stream when it is received from the resource.
Click the "Cloud stream" link for any Observation to see the information it is receiving.

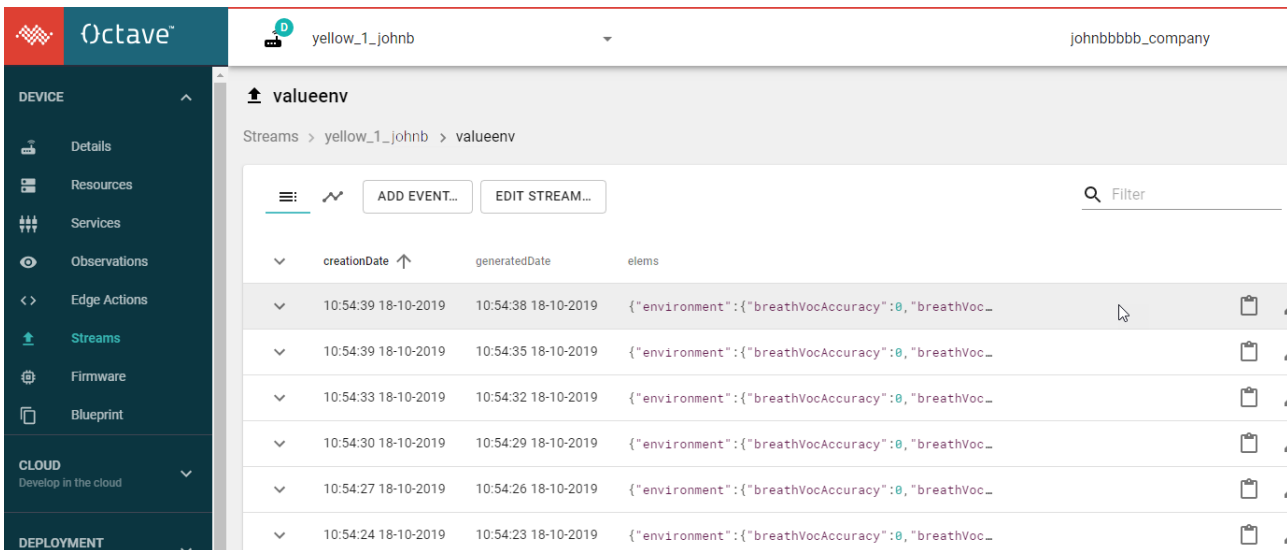
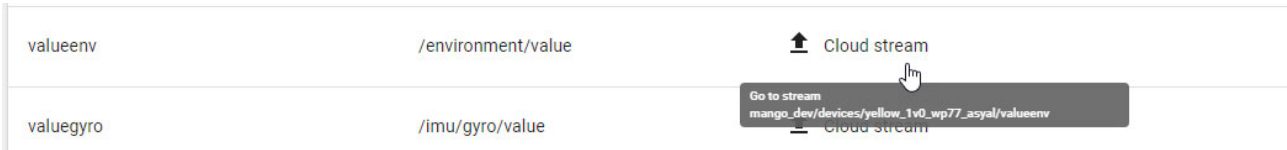

Note: The environment resource (shown here) is pre-configured to send sensor data every few seconds, so you should see the stream updating frequently. The reporting frequency is user-configurable.

5.3 Affect mangOH Yellow Resources from Octave

In addition to sending data to Octave from your mangOH Yellow, you can also directly change the mangOH Yellow's resource configurations (e.g. LED behavior, activate/deactivate the buzzer, etc.) from Octave.

For example (as a simple demonstration), to activate the mangOH Yellow's buzzer:

1. In the Octave menu, click Resources.

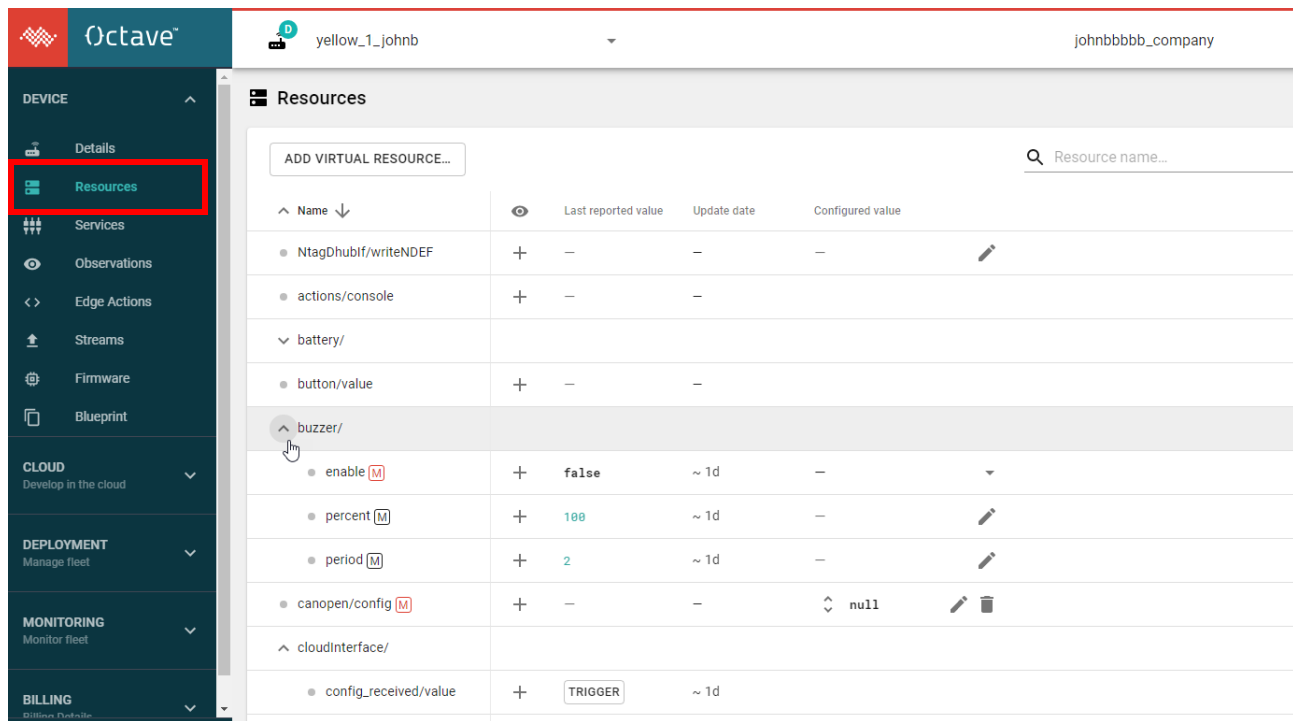

The screenshot shows the Octave web interface. The left sidebar contains a menu with categories: DEVICE, CLOUD, DEPLOYMENT, MONITORING, and BILLING. Under the DEVICE category, the 'Resources' option is highlighted with a red box. The main content area displays the 'Resources' page for a device named 'yellow_1_johnb'. It features a search bar and a table of resources. The table has columns for Name, Last reported value, Update date, and Configured value. The 'buzzer/' resource is expanded, showing sub-resources like 'enable', 'percent', 'period', and 'canopen/config'.

Name	Last reported value	Update date	Configured value
NtagDhublf/writeNDEF	+	-	-
actions/console	+	-	-
battery/			
button/value	+	-	-
buzzer/			
enable (M)	+	false	~ 1d
percent (M)	+	100	~ 1d
period (M)	+	2	~ 1d
canopen/config (M)	+	-	null
cloudInterface/			
config_received/value	+	TRIGGER	~ 1d



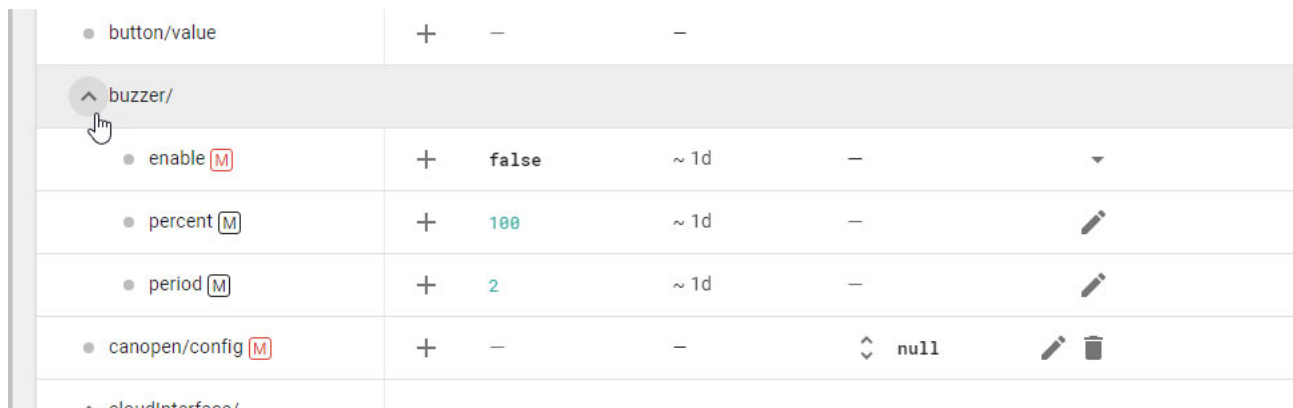

2. In the Resources list, expand "buzzer/" (if it is not already expanded).



This close-up screenshot shows the 'buzzer/' resource expanded in the Resources list. A mouse cursor is pointing at the expand/collapse icon next to 'buzzer/'. The sub-resources are visible, including 'enable', 'percent', 'period', and 'canopen/config'.

button/value	+	-	-
buzzer/			
enable (M)	+	false	~ 1d
percent (M)	+	100	~ 1d
period (M)	+	2	~ 1d
canopen/config (M)	+	-	null
cloudInterface/			

- In the enable row, expand the Configured value column and select true.

● button/value	+	-	-		
^ buzzer/					
● enable M	+	false	~ 1d		
● percent M	+	100	~ 1d	-	
● period M	+	2	~ 1d	-	
● canopen/confia M	+	-	-	^ null	 

- Click Apply.
The buzzer will begin to sound, based on the current 'percent' and 'period' settings.
- To deactivate the buzzer, expand the Configured value column again and select false.



You have successfully taken your first steps with your mangOH Yellow and completed the mangOH Yellow Getting Started tutorial.

BUT... There's a lot more you can do with your mangOH Yellow!

- For more information on the mangOH platform, visit mangoh.io.
- To explore Octave's features more deeply, visit sierrawireless.com/octave/developers.
- Begin developing simple applications or modifying existing applications
- Talk with other mangOH developers—visit the mangOH developers' forum at forum.mangoh.io.

A: Install Leaf and Build mangOH Software

Sierra Wireless' Leaf development workspace manager is designed to create and manage your mangOH development environment.

The Leaf installation process automatically downloads, installs and configures all necessary components for the development environment. After Leaf is installed, profiles are created for the targets you choose for development (e.g. mangOH Yellow with a WP module and specific firmware+Legato combinations).

To install Leaf on your development machine:

1. Download Leaf into a temporary folder (e.g. "/tmp" in this example):

```
$ wget https://downloads.sierrawireless.com/tools/leaf/leaf_latest.deb -O /tmp/leaf_latest.deb
```

2. Install Leaf.

```
$ sudo apt install /tmp/leaf_latest.deb
```

3. Configure Leaf to add the mangOH Git remote, which enables Leaf to search for mangOH targets. (This only needs to be done once, the configuration is persistent.)

```
$ leaf remote add mangOH https://downloads.sierrawireless.com/mangOH/leaf/mangOH-yellow.json --insecure
```

Note: The download connection is secured via TLS (Transport Layer Security). The "--insecure" option in this command simply tells Leaf not to use GPG (GNU Privacy Guard) to verify downloaded files. This is intentional.

4. Create a workspace (working directory) and then go to that directory. (e.g. create ~/myWorkspace to match the tutorial examples in <https://docs.legato.io/latest/confLeaf.html>.)

```
$ mkdir ~/myWorkspace
```

```
$ cd ~/myWorkspace
```

5. Search the leaf remotes for packages with the "mangOH" tag using the following command:

```
$ leaf search -t mangOH
```

```
$ leaf search -t mangOH
-----
|                               1 package - Filter: only master and +mangOH
|-----
| Identifier | Description
|-----
| mangOH-yellow-wp77xx_0.2.3 | SDK for mangOH yellow with wp77xx, based on Legato version 19.0
|-----
```

*Note: All matching packages are listed with detailed descriptions the search tags assigned to the packages. To see detailed information for each package, do the search with the "-v" (verbose) flag.
e.g. \$ leaf search -t mangOH -v*

Tip: Copy (or write down) the identifier of the package to be installed. (e.g. For this example, the identifier for the latest mangOH package is "mangOH-yellow-wp77xx_0.2.3".)

- a. Set up the current directory as a Leaf workspace and automatically create a profile for the target package, using the identifier from the previous step. This automatically downloads and installs the specified target package.

```
$ leaf setup -p mangOH-yellow-wp77xx_0.2.3
```

```
$ leaf setup -p mangOH-yellow-wp77xx_0.2.3
Cannot find workspace, initialize one in /home/mangoh/myWorkspace? (Y/n)
y
-> Execute: leaf init
Workspace initialized /home/mangoh/myWorkspace
No profile name given, the new profile will be automaticall named MANGO-YELLOW-WP77XX
...
$
```

Tip: Use the command as shown above to have the profile name assigned from the identifier, or enter your own unique name to identify the profile (e.g. "leaf setup -p mangOH-yellow-wp77xx_0.2.3 my_profile_name").

- i. When the prompt "Cannot find workspace, initialize in ..." appears, press Enter (or type 'Y' and press Enter) to create the profile.

Note: This prompt (and the next) appears only for the first profile you create, because the Leaf workspace must be initialized before first use.

- ii. When prompted to accept the license, type 'Y' and press Enter to display, read, and accept the license to continue.

Note: At any time, you can create additional profiles (for the same module series using different packages, or for other module types and their packages). To create additional profiles, repeat [Step 5](#) for each profile.

Important: Do not make any changes to `~/leaf`—that folder is managed by Leaf and contains files shared between all workspaces and profiles.

6. Clone the mangOH source code from the git repository into the workspace:

```
$ git clone --recursive https://github.com/mangOH/mangOH
```

7. Download and unpack a copy of the Bosch BSEC library, which is used by the environmental sensor app (included in the mangOH source code):

```
$ cd mangOH/components/boschBsec
```

```
$ wget https://community.bosch-sensortec.com/varuj77995/attachments/varuj77995/
bst_community-mems-forum/44/1/BSEC_1.4.7.2_GCC_CortexA7_20190225.zip
```

```
$ unzip BSEC_1.4.7.2_GCC_CortexA7_20190225.zip
```

8. Enter the Leaf shell to load the development environment with the most-recently used profile (in this case, the profile that was just created in this procedure). The shell now knows where the development environment components (e.g. Legato, toolchains, etc.) are located.

```
$ leaf shell
```

```
$ leaf shell
Leaf Shell /bin/bash started in Leaf environment.
(lsh:MANGO-YELLOW-WP77XX) $
```

Tip: The Leaf shell command prompt indicates the profile in use—in the example above, "(Ish:MANGOY-YELLOW-WP77XX)" indicates profile MANGOY-YELLOW-WP77XX is in use. If you leave the your workspace (e.g. go outside of ~/myWorkspace in these examples) the profile will not be active and the prompt will show "(Ish) \$".

Note: To return to the regular shell at any time, enter 'exit' at the Leaf shell command prompt.

9. Go back to the root of the mangOH directory and build the mangOH Yellow package:

```
$ cd $LEAF_WORKSPACE/mangOH
```

```
$ make yellow
```

The update package (yellow.wp77xx.update) is built in ./build/update_files and is ready to load on the mangOH Yellow.

10. To load the update on the mangOH Yellow, enter the following command:

```
$ update $LEAF_WORKSPACE/mangOH/build/update_files/yellow.wp77xx.update  
192.168.2.2
```

The mangOH Yellow is now updated with the software package.

Tip: For additional leaf-related commands, run "leaf help". For detailed information about the Leaf Workspace Manager including command details, instructions, tutorials, etc., visit <https://docs.legato.io/latest/confLeaf.html>.)

B: Updating the Firmware on a mangOH

There are a few ways to update the firmware of a mangOH board:

- Platform independent
- Linux
- Windows

The firmware on a mangOH board is updated over the mangOH's USB port.

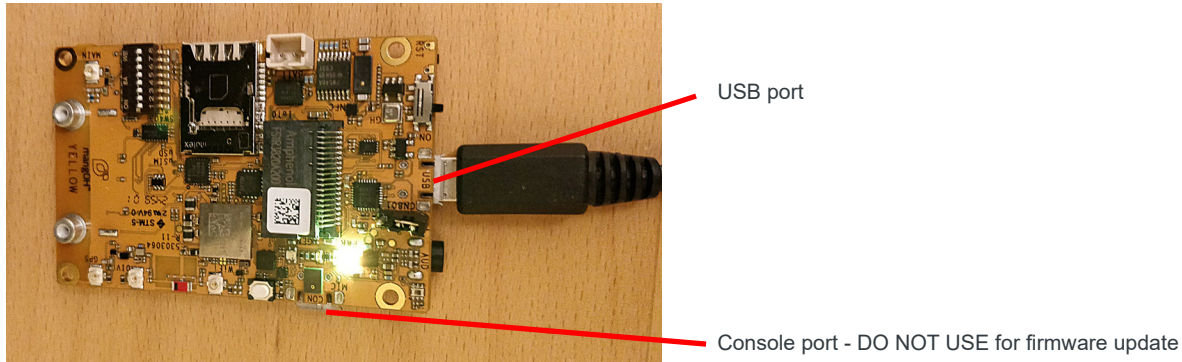

Platform-independent

This approach has the advantage of working using a Linux or Windows PC to perform the update. The disadvantage of this method is that it requires the user to login to the device via ssh or console and this is a bit inconvenient and may not even be possible if a bad firmware was installed previously.

1. Use a micro-USB cable to connect the mangOH's USB (not console) port to a powered USB port on your computer.
2. Locate the firmware .spk file that is to be installed and copy it to the mangOH:

```
$ scp some_file.spk root@192.168.2.2:/tmp
```
3. Log in to the mangOH:

```
$ ssh root@192.168.2.2
```
4. Install the firmware update:

```
# fwupdate download /tmp/some_file.spk
```
5. Press the reset button to restart the device. The device will boot with the new firmware.

Linux

1. Use a micro-USB cable to connect the mangOH's USB (not console) port to a powered USB port on your computer running Linux.
2. Locate the firmware .spk file that is to be installed and install it on the mangOH:

```
$ swiflash -m wp77xx path/to/some_file.spk
```

Note: If you're using leaf, the swiflash command may have already been installed. If not, source.sierrawireless.com has installation instructions for leaf.

3. Press the reset button to restart the device. The device will boot with the new firmware.
-

Windows

1. Use a micro-USB cable to connect the mangOH's USB (not console) port to a powered USB port on your computer running Windows.
2. Locate the firmware .exe file that is to be installed.
3. Log in to the mangOH:

```
$ ssh root@192.168.2.2
```

4. Stop legato:

```
# legato stop
```

Note: The software in the firmware .exe file does not wait long enough for a device that is running Legato to enter the mode where it is ready for programming. By stopping Legato before running the .exe, the device will be able to enter programming mode quickly enough when the .exe is run.

5. On your PC, double-click the firmware .exe file to install it on the mangOH.
6. Press the reset button to restart the device. The device will boot with the new firmware.

Troubleshooting

- If the platform-independent method doesn't work, try the platform-specific Linux or Windows methods.
- If the Linux or Windows methods are not working:
 - a. Try moving the TP1_BOOT DIP switch into the ON position and then press the reset button before initiating programming.

Note: On the mangOH Yellow, TP1_BOOT is DIP switch 2 on SW403. On the mangOH Red, TP1_BOOT is DIP switch 7 on SW401.

- b. Once programming has begun, move the TP1_BOOT DIP switch back to the OFF position. On the mangOH Yellow, TP1_BOOT is DIP switch 2 on SW403.