

DO NOT SCALE FROM THIS PRINT

- NOTES:
1. USE ASP-103597-01-B BODY FOR NON-STANDARD 19 POSITION.
 2. Ⓢ REPRESENTS A CRITICAL DIMENSION.
 3. MAXIMUM BURR ALLOWANCE: .0005[0.013]
 4. MINIMUM PUSHOUT FORCE: .5 LB
 5. MAXIMUM ALLOWABLE BOW: .002[0.05] INCH/INCH AFTER ASSEMBLY.
 6. CONTACT TO BE FLUSH ±.002[0.05]
 7. ONE REEL MINIMUM PLATING REQUIREMENT (85,000 CONTACTS PER REEL).
 8. ALL DIMS TO BE SYMMETRICAL ABOUT THE CENTERLINE WITHIN ±.001[0.03].
 9. MAXIMUM VARIATION BETWEEN SOLDERBALLS: .0025[0.064]
 10. REFER TO VISUAL INSPECTION BOARD FOR SOLDERBALL APPEARANCE CHECKS.
 11. THE DISTANCE FROM THE CENTER OF ANY SOLDERBALL TO THE CENTER OF ANY ADJACENT INNER PEG SHALL BE .025±.005[0.64±0.13].
 12. PARTS TO BE PACKAGED IN TAPE & REEL. FOR QTY'S LESS THAN 125 PCS, NO TRAILER OR LEADER WILL BE SUPPLIED.

ANY REV MADE TO THIS PRINT MUST HAVE AN UPDATED MKT PRINT

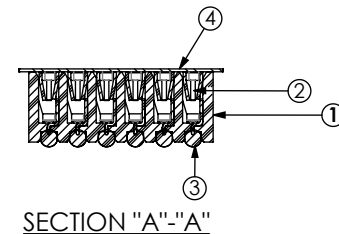
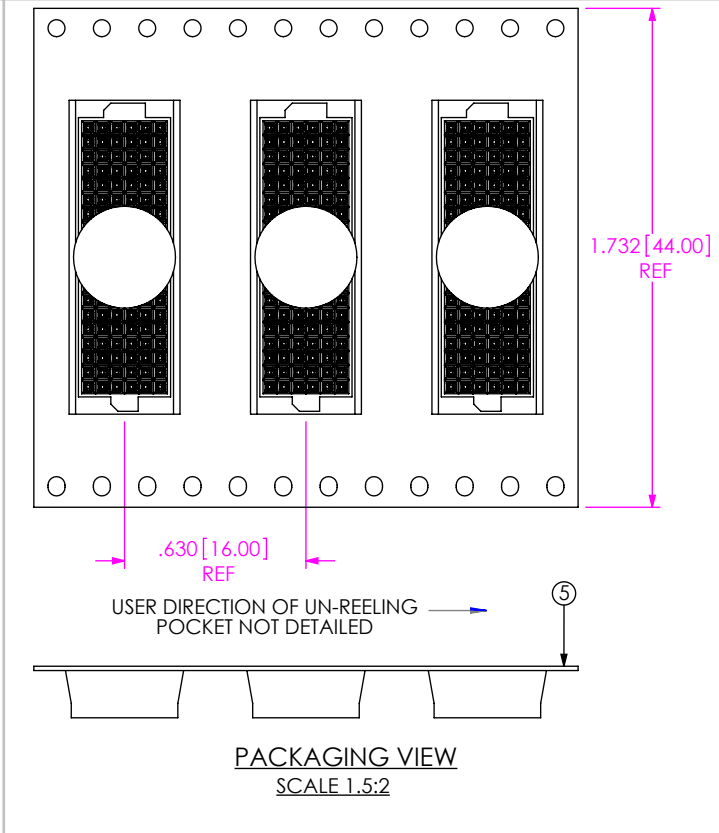
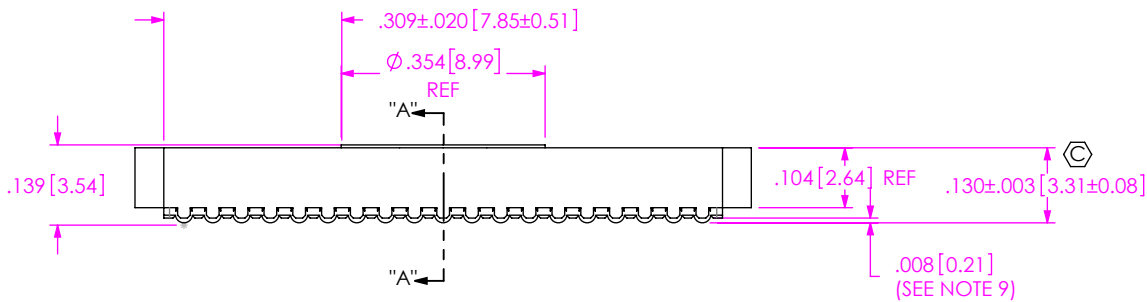
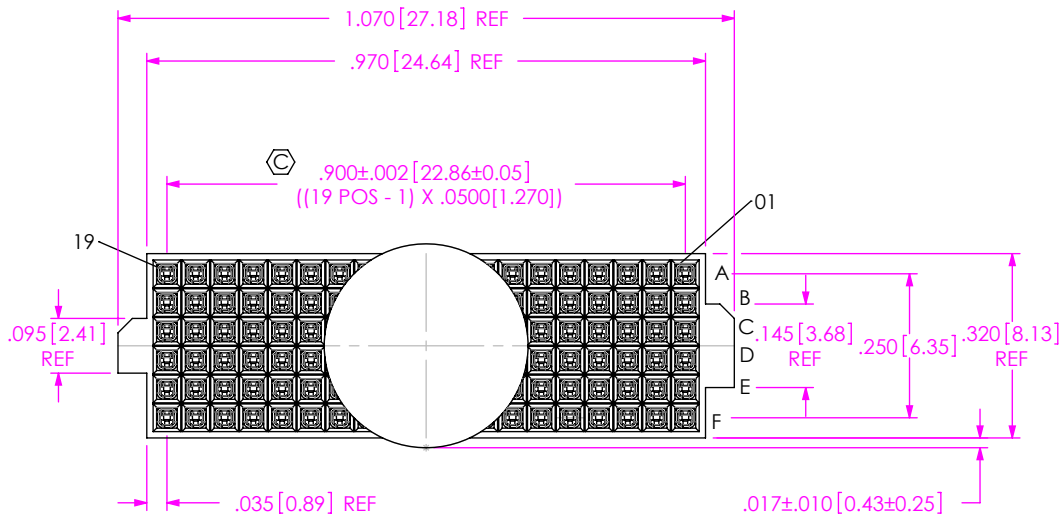

ITEM NO.	PART NUMBER	QUANTITY	MATERIAL
1	ASP-103597-01-B	1.0000	UL 94 V0, COLOR: BLACK
2	C-140-03-H	114.00	PHOS BRONZE, 521 HARD TEMPER
3	SDB-030-6337	114.00	63% TIN /37% LEAD
4	K-DOT-.354-.469-.005	1.0000	POLYIMIDE FILM
5	CT-ASP1132MS	1.0000	CONDUCTIVE POLYMER

UNLESS OTHERWISE SPECIFIED, DIMENSIONS ARE IN INCHES.

TOLERANCES ARE:
 DECIMALS ANGLES
 .XX: ±.01[0.3] 2°
 .XXX: ±.005[0.13]
 .XXXX: ±.0020[0.051]

PROPRIETARY NOTE
 THIS DOCUMENT CONTAINS CONFIDENTIAL AND PROPRIETARY INFORMATION AND ALL DESIGN, MANUFACTURING, REPRODUCTION, USE, PATENT RIGHTS AND SALES RIGHTS ARE EXPRESSLY RESERVED BY SAMTEC, INC. THIS DOCUMENT SHALL NOT BE DISCLOSED, IN WHOLE OR PART, TO ANY UNAUTHORIZED PERSON OR ENTITY NOR REPRODUCED, TRANSFERRED OR INCORPORATED IN ANY OTHER PROJECT IN ANY MANNER WITHOUT THE EXPRESS WRITTEN CONSENT OF SAMTEC, INC.

DO NOT SCALE DRAWING SHEET SCALE: 3:1

PLATING:
 CONTACT AREA: .000030 GOLD OVER .000050 NICKEL
 REMAINDER: .000003 FLASH GOLD OVER .000050 NICKEL

DESCRIPTION:
 VITA 42 (LEADED) SOCKET ASSEMBLY

DWG. NO. ASP-103612-01

BY: BRYANT 10/22/2002 SHEET 1 OF 2

F:\DWG\MISC\MKTG\ASP-103612-01-MKT.SLDDRW



520 PARK EAST BLVD. NEW ALBANY, IN 47150
 PHONE: 812-944-6733 FAX: 812-948-5047
 e-Mail: info@SAMTEC.com code 55322

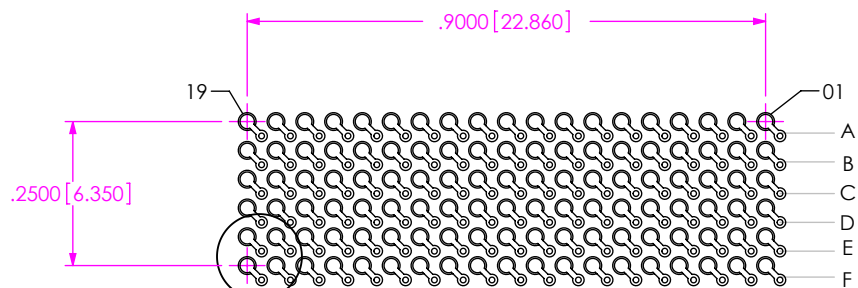

"A"
NOTE:
OUTER ROWS MAY NOT NEED VIAS - THIS IS LEFT TO
THE DISCRETION OF THE BOARD DESIGNER.

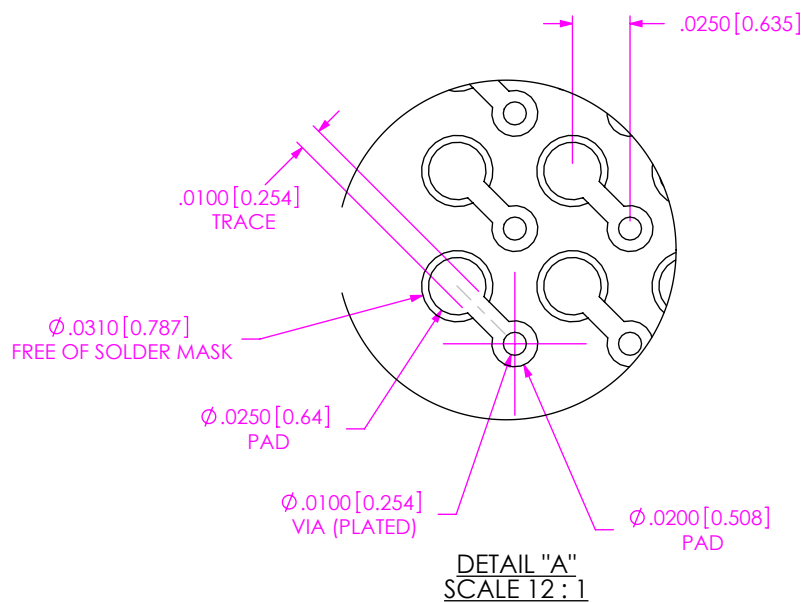

DETAIL "A"
SCALE 12:1

RECOMMENDED BOARD LAYOUT

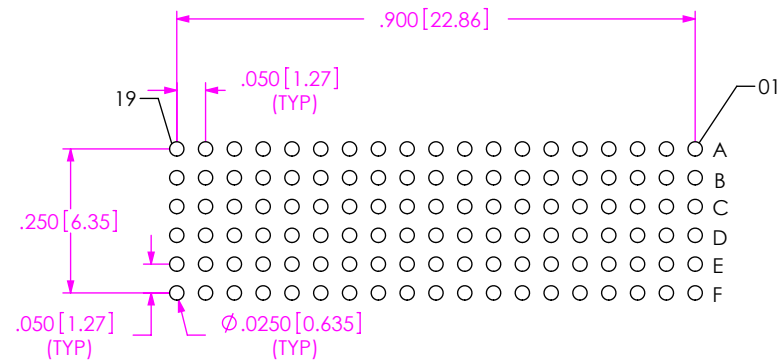

RECOMMENDED STENCIL LAYOUT
STENCIL TO BE .0060[0.152] THICK

PROPRIETARY NOTE

THIS DOCUMENT CONTAINS CONFIDENTIAL AND PROPRIETARY INFORMATION AND ALL DESIGN, MANUFACTURING, REPRODUCTION, USE, PATENT RIGHTS AND SALES RIGHTS ARE EXPRESSLY RESERVED BY SAMTEC, INC. THIS DOCUMENT SHALL NOT BE DISCLOSED, IN WHOLE OR PART, TO ANY UNAUTHORIZED PERSON OR ENTITY NOR REPRODUCED, TRANSFERRED OR INCORPORATED IN ANY OTHER PROJECT IN ANY MANNER WITHOUT THE EXPRESS WRITTEN CONSENT OF SAMTEC, INC.



520 PARK EAST BLVD, NEW ALBANY, IN 47150
PHONE: 812-944-6733 FAX: 812-948-5047
e-Mail info@SAMTEC.com code 55322

SHEET SCALE: 3:1

DESCRIPTION:
VITA 42 (LEADED) SOCKET ASSEMBLY

DWG. NO.
ASP-103612-01

BY: BRYANT 10/22/2002 SHEET 2 OF 2