

Recommended P.C. Board Layout
SCALE 4:1

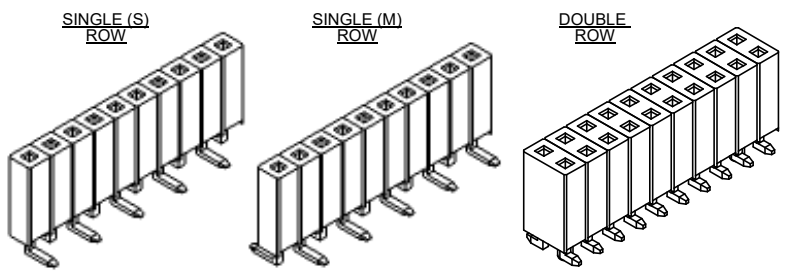
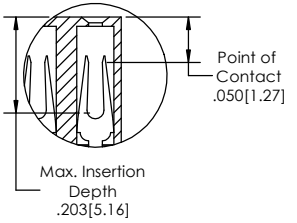
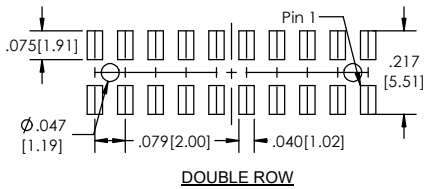
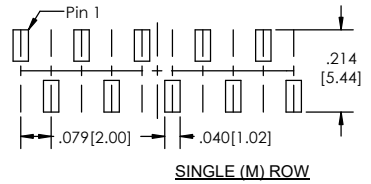
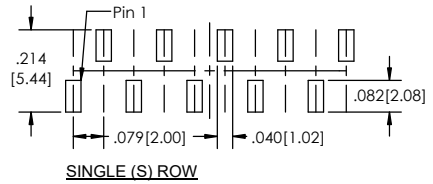

SSHSM-2 **XX** - **X** - **02** - **XX** - **V** - **XXX** - **X** - **XX** - **X** - **XX** - **LF**
(A) **(B)** **(C)** **(D)** **(E)** **(F)** **(G)** **(H)** **(I)** **(J)** **(K)**

- A. Pins Per Row**
- 1 through 40
- B. Row Specification**
- S= Single Row
- D= Double Row
- C. Surface Mount**
- D. Plating Options**
- See Plating Options below
- E. Vertical**
- F. Polarized Position**
- Leave blank if not needed
- If required, specify empty pin position
- e.g. 012 for Pin 12
- G. Footprint**
- S= pin 1 right
- M= pin 1 left
- H. Packing Information**
- TR= Tape and Reel
- TB= Tube
- I. Pad**
- P= Plastic
- K= Kapton
- O= No Pad
- If left blank packaging at MLE's discretion
Pad may be metal, mylar or plastic
- J. Alignment pin (only available for the Double Row)**
- If not needed leave blank
- AP= with
- K. Lead Free**
- Mates with:
 BSTC TSHR
 BSTCM TSHRE
 BSTCR TSHS
 BSTCRSM TSHSCM
 BSTS TTSHC
 TBSTC TTSHCR
 TBSTCM TTSHCRE
 TBSTS TTSHR
 TSHC TTSHRE
 TSHCR TTSHS
 TSHCRE TTSHSM
 TSHCRSM

APPLICATION

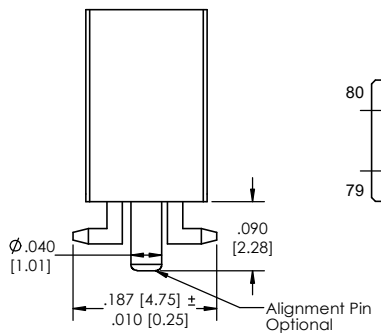
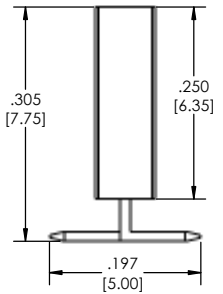
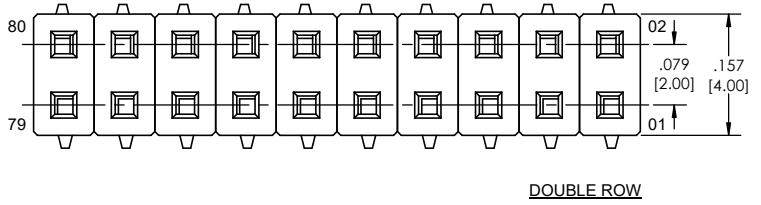
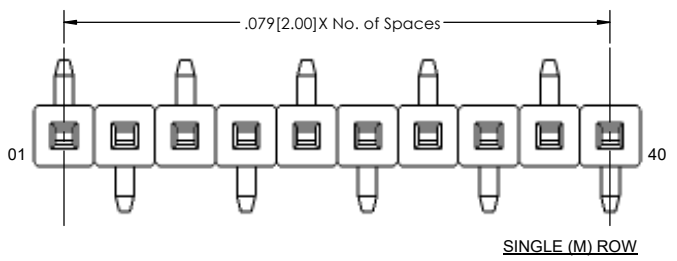
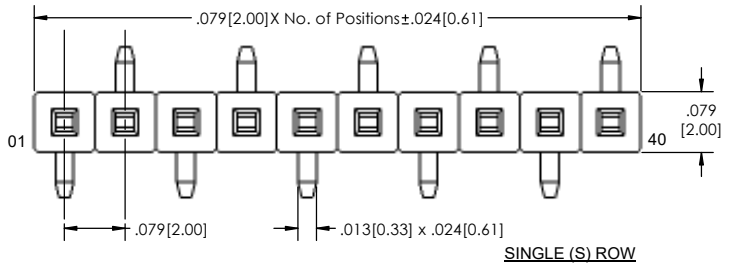
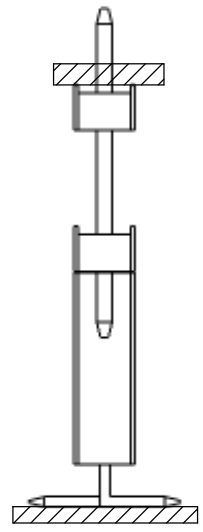

Plating options	
G	-10µ Gold on Contact Area/ Flash on Tail
T	-Matte Tin all Over
GT	-10µ Gold on Contact Area/ Matte Tin on Tail
H	-30µ Gold on Contact Area/ Matte Tin on Tail
F	-Gold Flash over Entire Pin
FT	- Gold Flash on Contact Area/ Matte Tin on Tail

Specifications:
 Insertion Force- Single Contact only- H Plating:
 4oz: [1.11N] avg with .079[2.00mm] sq. pin
 Withdrawal Force- Single Contact only- H Plating:
 3oz: [0.83N] avg with .079 [2.00mm] sq. pin
 Current Rating: 2.0 Ampere
 Insulation Resistance: 1000M Ohms Min.
 Dielectric Withstanding: 500V AC
 Contact Resistance: 10M Ohms Max.
 Operation Temperature: -40°C to +105°C
 Max. Process Temperature
 Peak: 260°C up to 10 secs.
 Process: 230°C up to 60 secs.
 Wave: 260°C up to 6 secs.
 Reflow: 260°C up to 10 secs.
 Manual Solder: 350°C up to 5 secs.

Materials:
 Contact Material: Phosphor Bronze
 Insulator Material: Nylon 6T
 Plating: Au or Sn over 50µ" (1.27) Ni

Tails may be clipped to achieve specific dimensions.
 Products cut to specific sizes are uncancellable/ nonreturnable.
 Parts are subject to change without notice.

ROHS COMPLIANT
 PROPRIETARY AND CONFIDENTIAL
 THE INFORMATION CONTAINED IN THIS DRAWING IS THE SOLE PROPERTY OF Major League Electronics. ANY REPRODUCTION IN PART OR AS A WHOLE WITHOUT THE WRITTEN PERMISSION OF Major League Electronics IS PROHIBITED.

UNLESS OTHERWISE SPECIFIED:		NAME		DATE
DIMENSIONS ARE IN INCHES		DRAWN	EOW	01/21/15
TOLERANCES:		CHECKED	GWE	01/21/15
ONE DECIMALS ±.100		ENG APPR.		
TWO DECIMAL ±.100		MFG APPR.		
THREE DECIMAL ±.005		ADDRESS:		
FOUR DECIMAL ±.002		2533 Centennial Blvd. Jeffersonville, IN 47130 Phone: 812-670-4174 Fax: 812-670-4175 E-Mail: mle@mlelectronics.com		
NEXT ASSY	USED ON	TITLE: SSHSM-2-V SERIES		
APPLICATION	DO NOT SCALE DRAWING	SIZE	DWG. NO.	REV
		C		C
		SCALE 8:1		SHEET 1 OF 1

