

REF_MA5332BTLSPS

MA5332M reference board

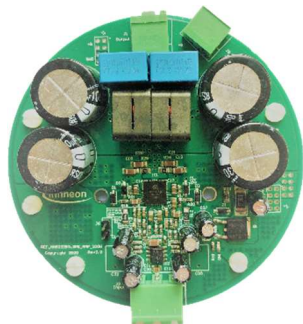

About this document

Scope and purpose

The REF_MA5332BTLSPS reference board is a one BTL channel, 200 W/ch (4 Ω at 40 V) class D audio power amplifier for home audio systems. This reference board demonstrates how to use MA5332MS IC with a single power supply and design an optimum PCB layout using Infineon integrated Class D IC. This reference design does not require additional heatsink or fan cooling for normal operation (one-eighth of continuous rated power). The reference design provides all the required housekeeping power supplies for ease of use.

Applications

- Smart speakers
- Sound bars
- Sub-woofers
- Powered speakers
- Musical instrument amplifiers
- Car audio amplifiers

Features

- Output power:
 - 200 W x 1 channels (10 percent THD+N, 4 Ω at 40 V)
- Multiple protection features:
 - Over-Current Protection (OCP), high-side and low-side
 - Over-Temperature Protection (OTP)
- PWM modulator:
 - Self-oscillating half-bridge topology with optional clock synchronization

Table of contents

About this document.....	1
Table of contents.....	2
1 Specifications	3
2 REF_MA5332BTLSPS overview	4
3 Set-up guide	5
4 Audio analyzer set-up	6
5 Operating the evaluation board	7
5.1 Test set-up.....	7
5.2 Power-up sequence.....	7
5.3 Audio functionality tests.....	7
5.4 Power-down sequence	7
6 Audio performance.....	8
6.1 Power vs. THD+N.....	8
6.2 Frequency response.....	8
6.3 Noise floor.....	9
6.4 Noise floor with 1 V _{RMS} output	9
7 Efficiency	10
8 Thermal information	11
8.1 Thermal performance	11
8.2 Heatsink.....	12
9 Gain setting	13
9.1 Gain design flow	13
9.2 Vbus Calculation.....	14
9.3 AC gain setting:.....	14
9.4 DC gain setting:.....	15
10 Schematic	16
11 PCB.....	17
11.1 PCB specification.....	17
11.2 PCB layout	18
12 Bill of Materials (BOM)	20
Revision history.....	23

1 Specifications

Table 1 General test conditions

Condition		Notes/conditions
Supply voltages	+40 V	Unipolar power supply
Rated load impedance	4 Ω	Resistive load
Self-oscillating frequency	400 kHz	No input signal, adjustable
Voltage gain	23 dB	1Vrms input yields rated power

Table 2 Electrical data

Data	Typical	Notes/conditions
Infineon devices	MA5332MS integrated class D IC	
Modulator	Self-oscillating, second-order sigma-delta modulation, analog input	
Output power: (1 percent THD+N)	150 W	1 kHz, RL = 4 Ω
Output power: (10 percent THD+N)	200 W	1 kHz, RL = 4 Ω
Rated load impedance	4 Ω	Resistive load
Idling supply current	+75 mA	No input signal, +40 V
Signal-to-noise Ratio(SNR)	96dB	Filter: A-weighting(12017), 20 kHz SPCL Gain setting:23dB
Residual noise	140 μ V	Filter: A-weighting(12017), 20 kHz SPCL Gain setting:23dB
Channel efficiency	90 percent	Single-channel driven, 200 W, class D stage

2 REF_MA5332BTLSPS overview

The REF_MA5332BTLSPS features a one BTL channel self-oscillating type PWM modulator for the lowest component count, convenient single power supply and highest performance and robust design. This topology represents an analog version of a second-order sigma-delta modulation, with the class D switching stage inside the loop. The benefit of the sigma-delta modulation, in comparison to the carrier-signal based modulation, is that all the error in the audible frequency range is shifted to the inaudible upper-frequency range by nature of its operation. Also, sigma-delta modulation enables the designer to apply sufficient error correction.

The REF_MA5332BTLSPS self-oscillating topology consists of the following essential functional blocks:

- Front-end integrator
- PWM comparator
- Level shifters
- Integrated gate drivers and MOSFETs
- Output LPF

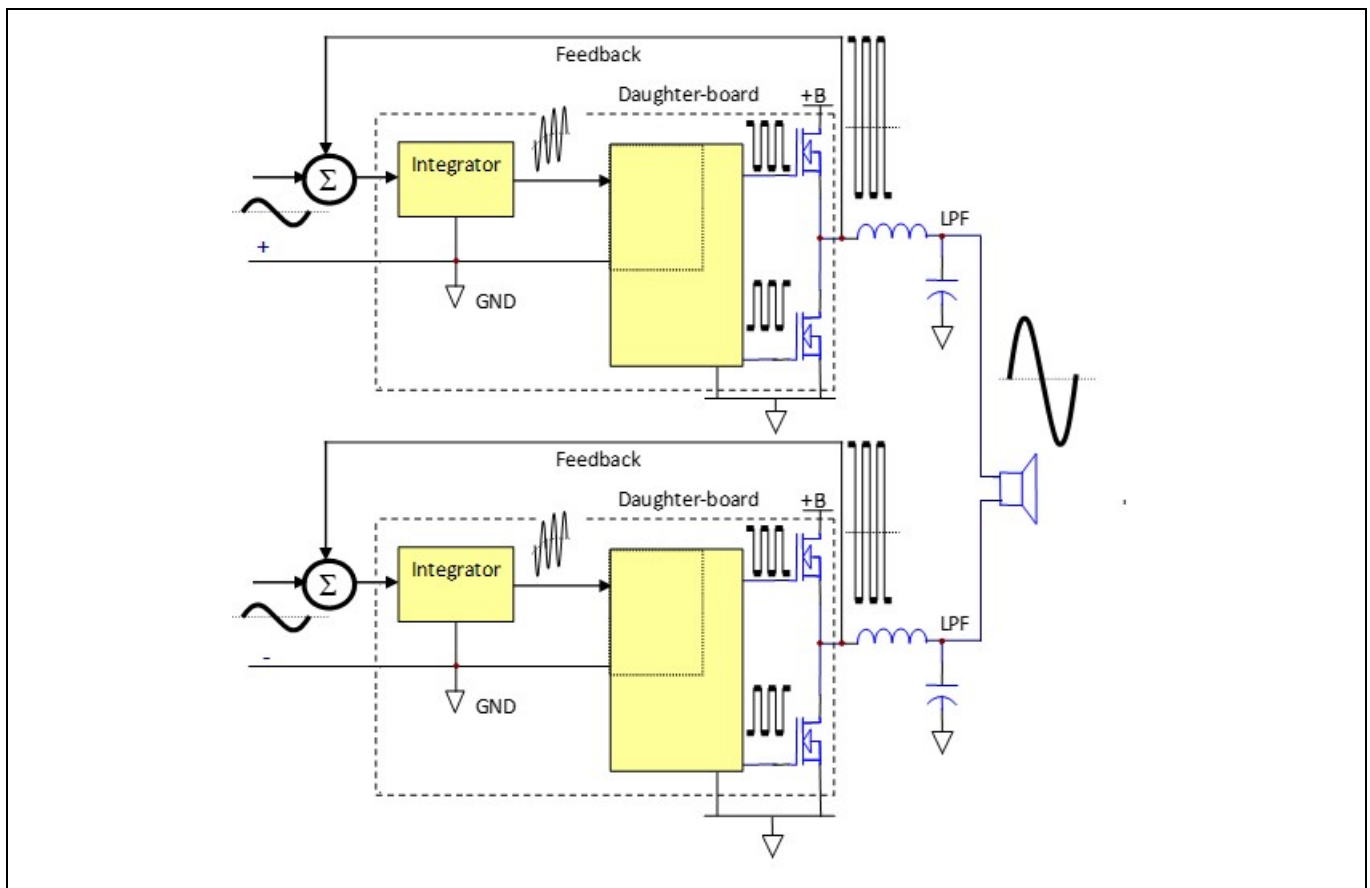

Figure 1 Simplified block diagram of class D amplifier

3 Set-up guide

Typical connections

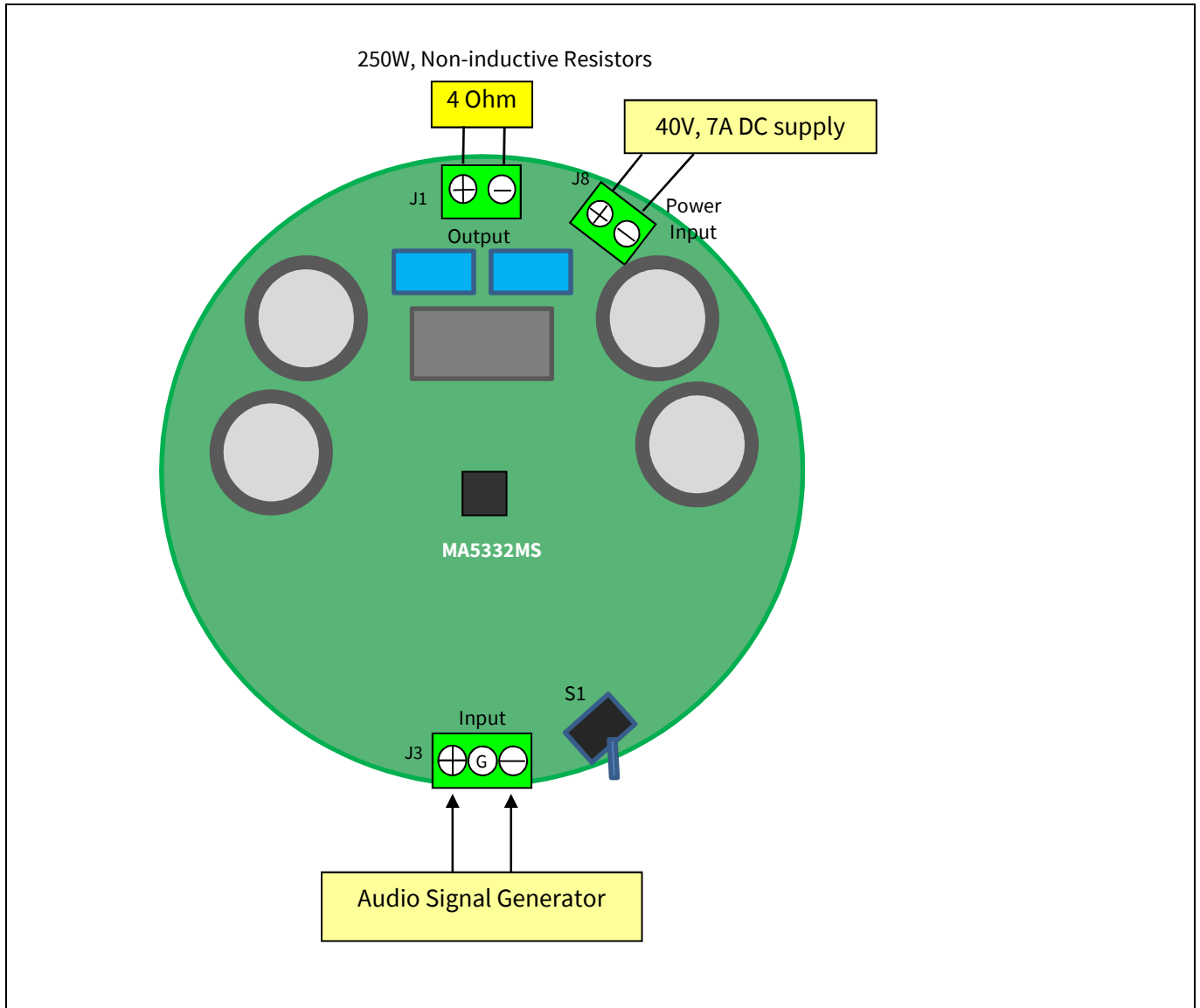

Figure 2 Typical connection connector description

Table 3 Connector description

ANALOG INPUT	J3	Analog balanced input
OUTPUT	J1	Analog output
POWER	J8	Single power supply

5 Operating the evaluation board

5.1 Test set-up

1. Connect 4 Ω 250 W dummy loads to output connector (J1 as shown in Figure 2) and parallel it with the input of the Audio Precision (AP) analyzer.
2. Connect the Audio Signal Generator (ASG) to J3 for analog signal respectively (AP).
3. Set up the power supply with voltages of 40 V; set the current limit to 7 A.
4. Turn off the power supply before connecting to “on” of the Unit Under Test (UUT).
5. Connect the power supply to J8, as shown in Figure 2

5.2 Power-up sequence

6. Turn on the power supply.
7. Quiescent current for the supply should be 75 mA \pm 10 mA at 40 V.
8. Turn on the switch S1(middle position)

5.3 Audio functionality tests

8. Set the AP’s analog analyzer to 20 kHz AES17 filter.
9. Connect the audio signal from the AP to J3.
10. Sweep the audio signal voltage from 15 mV_{RMS} to 1.5 V_{RMS}.
11. Run the AP test as shown in Figures 4 to 11, below.

5.4 Power-down sequence

13. Turn off the switch S1(side position)
14. Turn off power supply
15. All LEDs turn off when housekeeping power supplies are off.

6 Audio performance

6.1 Power vs. THD+N

Test conditions:

$V_{bus} = 40\text{ V}$

Input signal = 1 kHz

Load impedance = $4\ \Omega$

$F_{PWM} = 400\text{ kHz}$

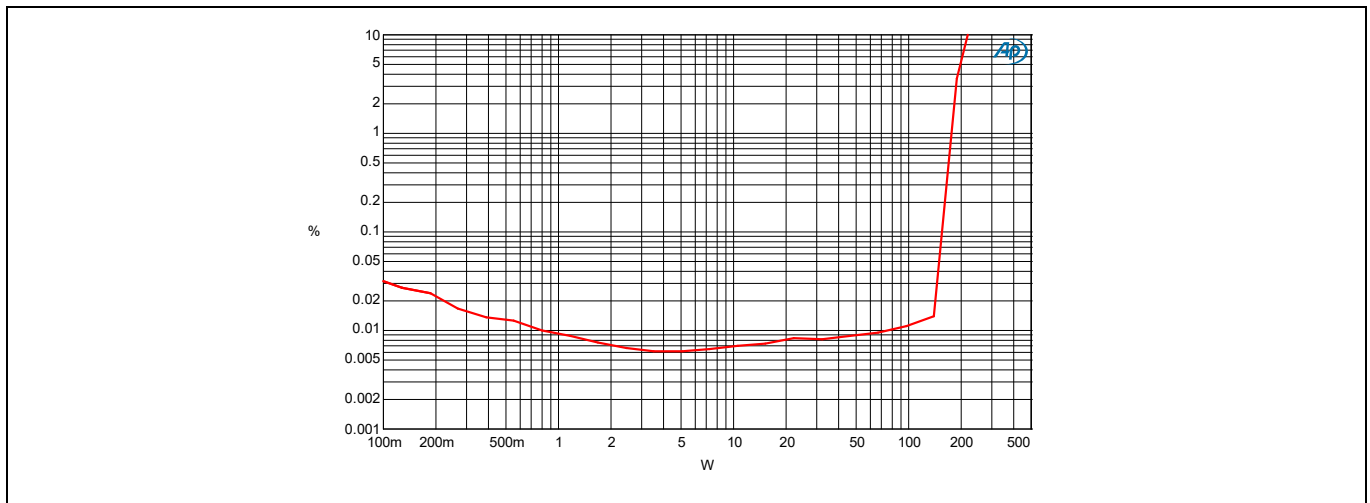

Figure 4 Power vs. THD+N $4\ \Omega$ load

6.2 Frequency response

Test conditions:

$V_{bus} = 40\text{ V}$

Output power = 1 W

Load impedance = $4\ \Omega$

$F_{PWM} = 400\text{ kHz}$

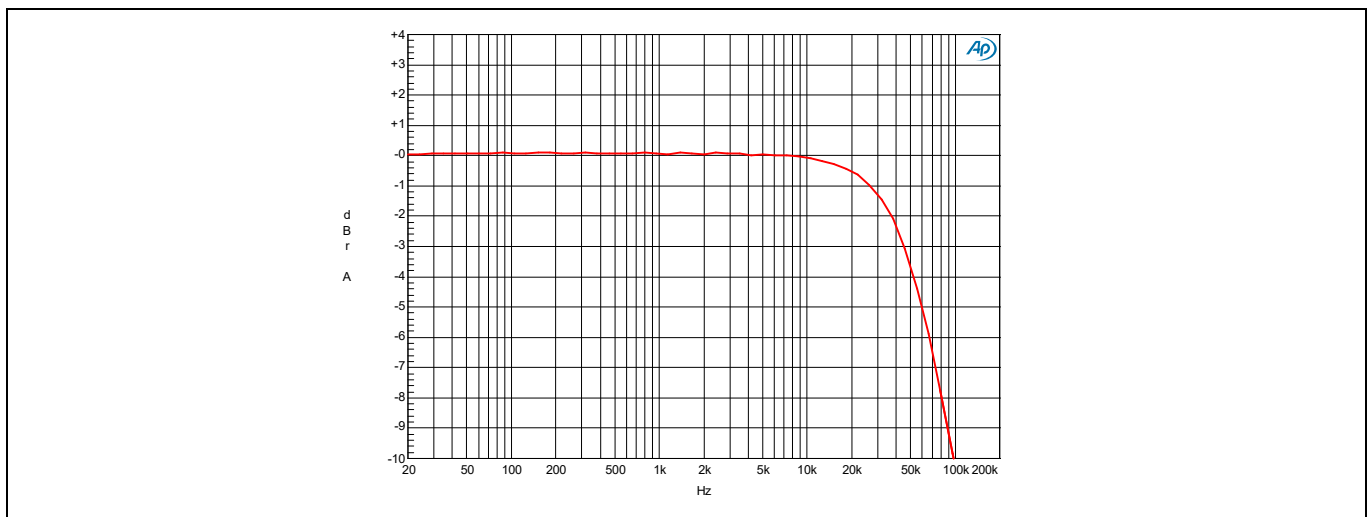

Figure 5 Frequency response $4\ \Omega$ load

6.3 Noise floor

Test conditions:

$V_{bus} = 40\text{ V}$

No input signal

Load impedance = $4\ \Omega$

$F_{PWM} = 400\text{ kHz}$

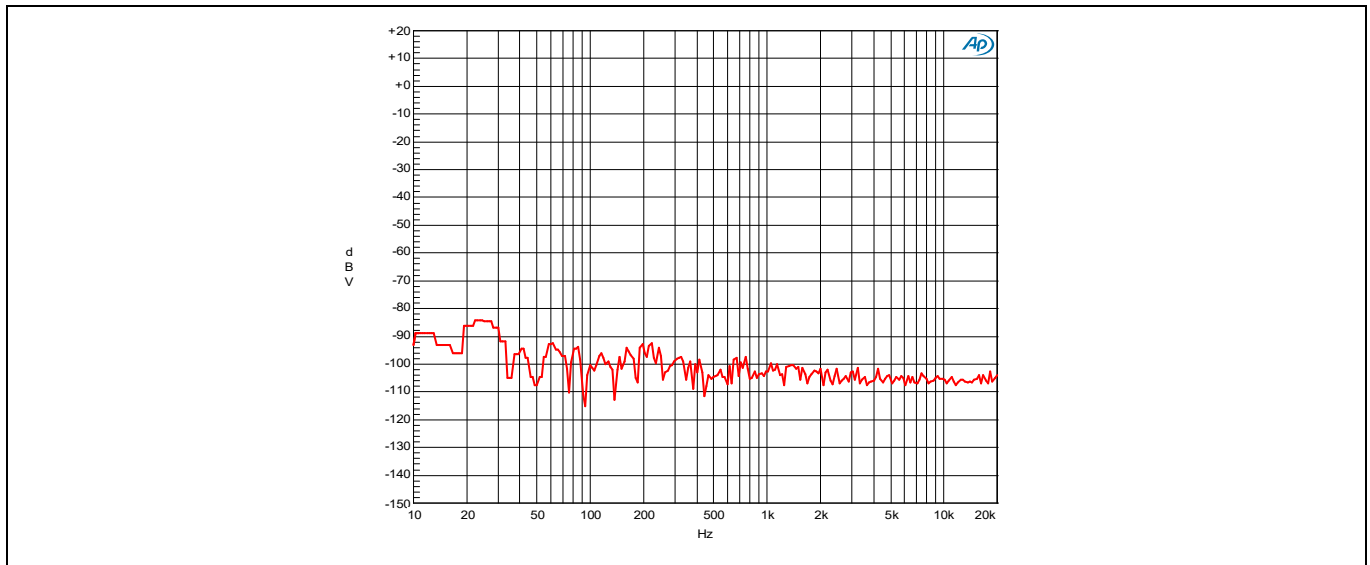

Figure 6 Noise floor $4\ \Omega$ load

6.4 Noise floor with 1 V_{RMS} output

Test conditions:

$V_{bus} = 40\text{ V}$

Output = 1 V_{RMS} at 1 kHz

Load impedance = $4\ \Omega$

$F_{PWM} = 400\text{ kHz}$

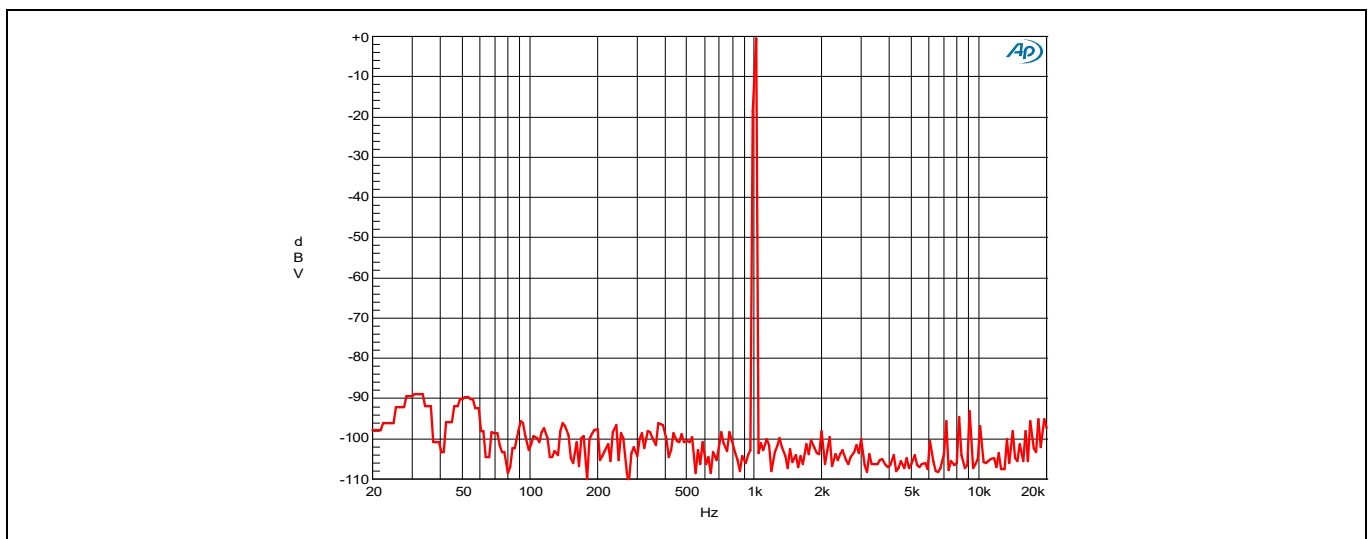

Figure 7 Noise floor with 1 V_{RMS} output $4\ \Omega$ load

7 Efficiency

Test conditions:

$V_{bus} = 40\text{ V}$

Output = 1 V_{RMS} at 1 kHz

Load impedance = $4\ \Omega$

$F_{PWM} = 400\text{ kHz}$

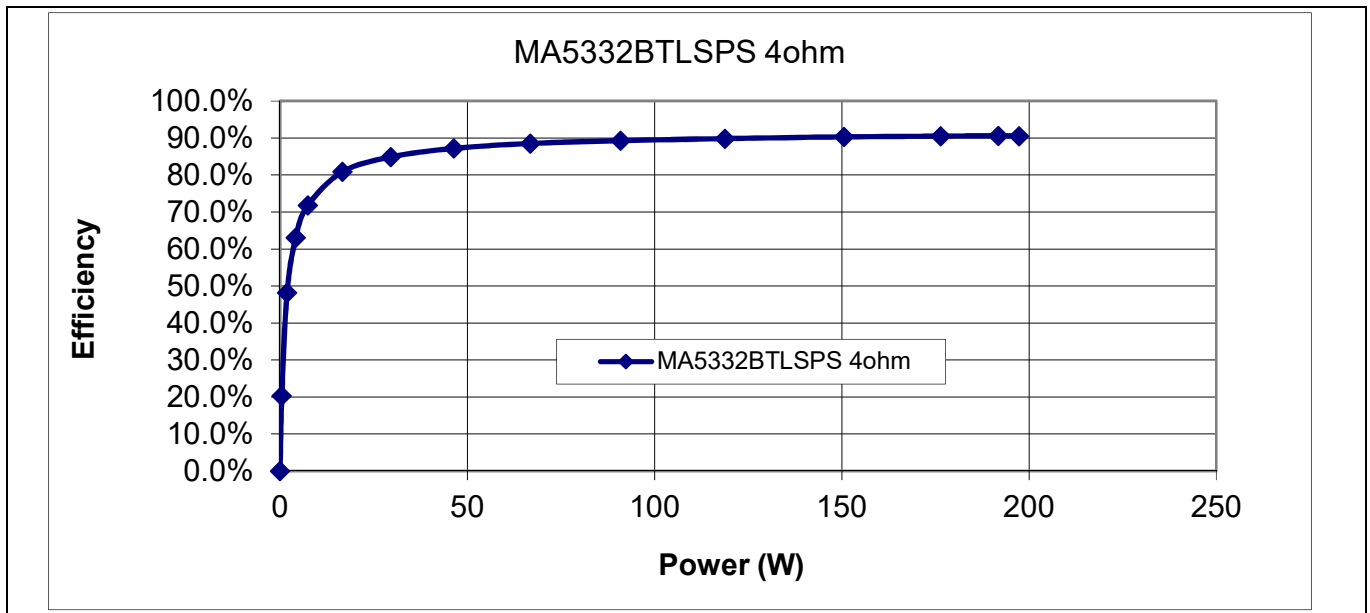

Figure 8 REF_MA5332BTLSPS 4 Ω load stereo, $V_{bus} = 40\text{ V}$

8 Thermal information

Test conditions:

$V_{bus} = 40V$

Input signal = 1 kHz

Both channels driven

$F_{PWM} = 400 \text{ kHz}$

Load = 4Ω

8.1 Thermal performance

Table 4 Thermal performance (with heatsink)

Output Power(W)	Tc(°C)	Record time
18.75	71.4	30(minutes)
200	109	1(minute)
200	144	5(minutes)

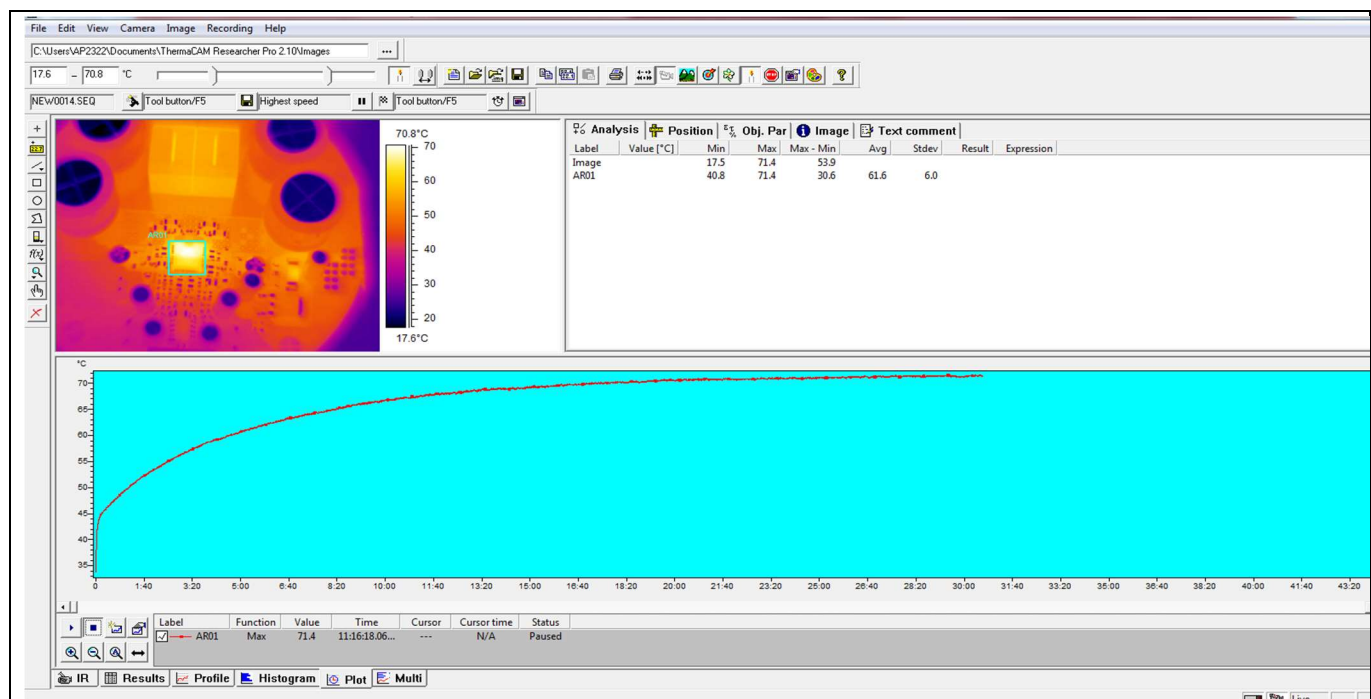

Figure 9 1/8Po power $P_{out} = 18.75 \text{ W}$ with 4Ω load 40 V with heatsink

Note: Temperature saturated at 71.4°C after 30 minutes,

REF_MA5332BTLSPS
MA5332MS reference board
200 W class D amplifier

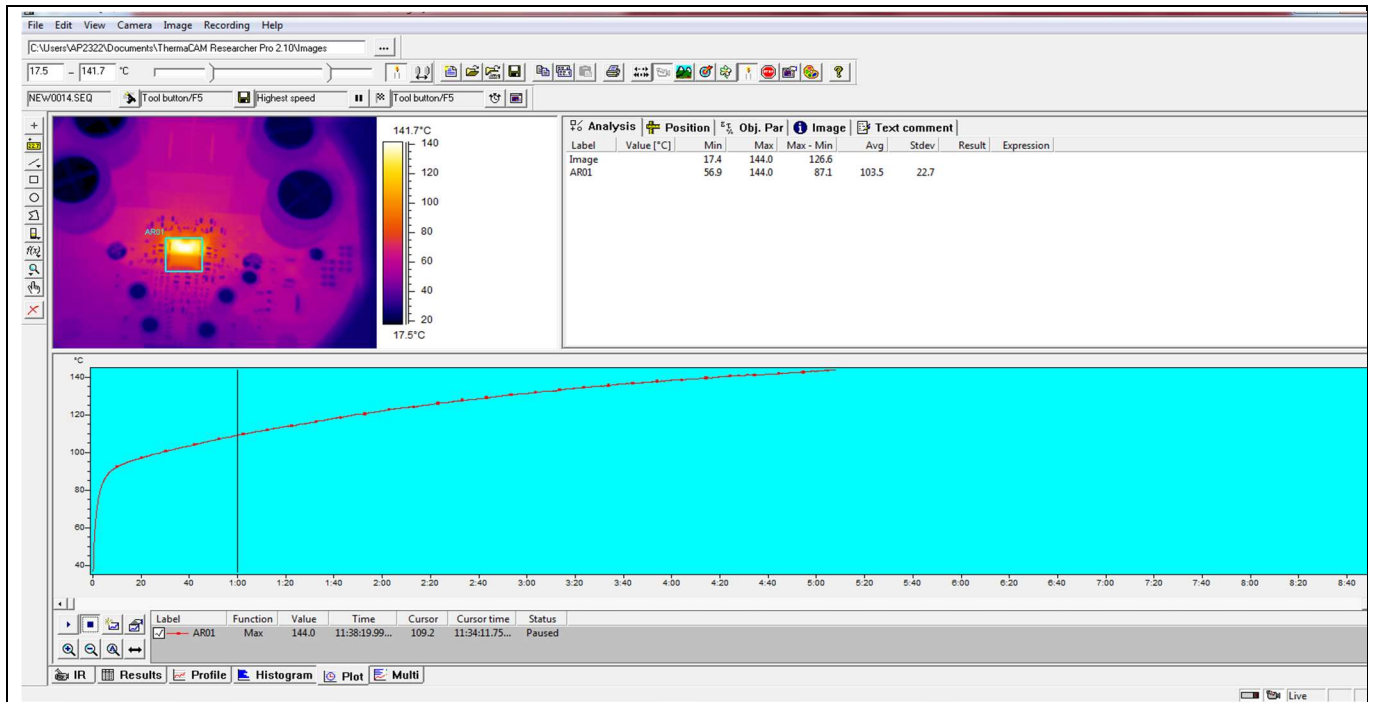

Figure 10 Peak power $P_{out} = 200\text{ W}$ with $4\ \Omega$ load 40 V with heatsink

Note: Maximum temperature 109.2°C at 1 minute and 144°C at 5 minutes.

8.2 Heatsink

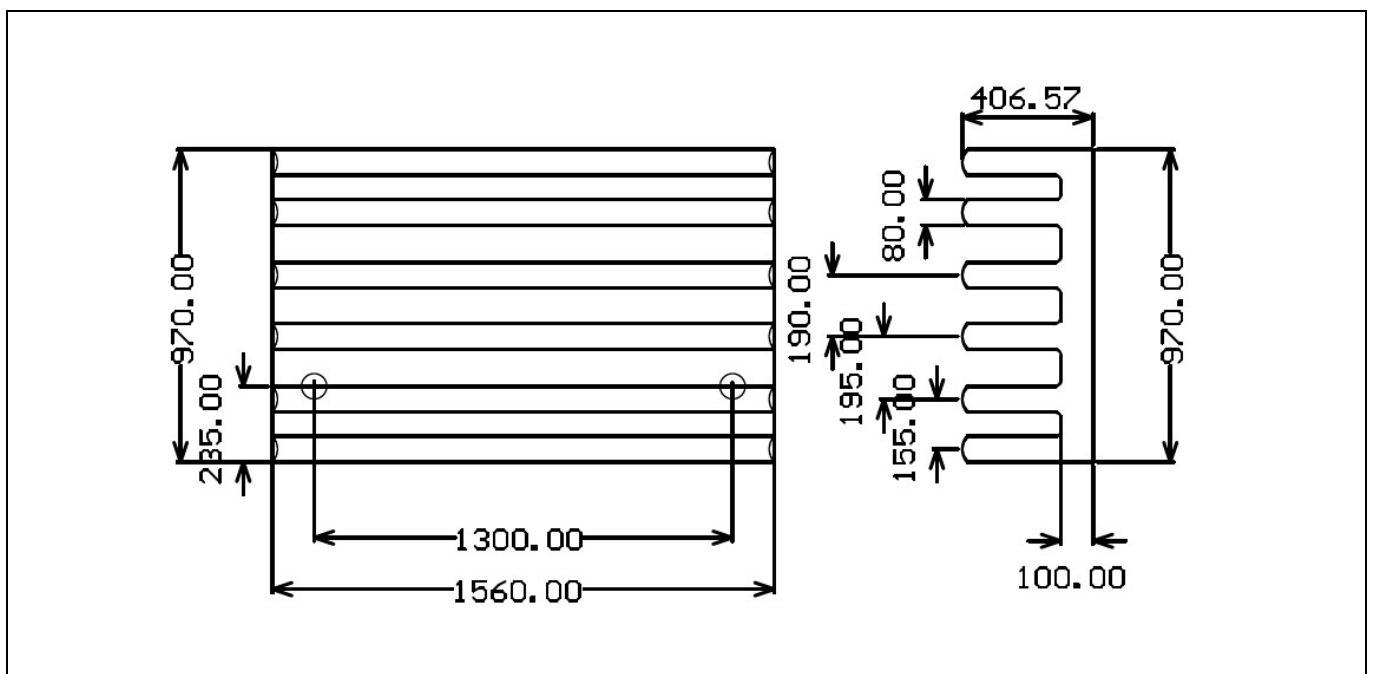

Figure 11 Heatsink dimension

9 Gain setting

REF_MA5332BTLSPS reference board has two gain settings for the single power supply application, which is different from split power supplies application. The AC gain setting (red path in Figure 12) is the same as the normal gain setting, the ratio of RFB and Rin is the AC gain. The DC gain setting (blue path in Figure 12) depends on the desired bus voltage & rated output power.

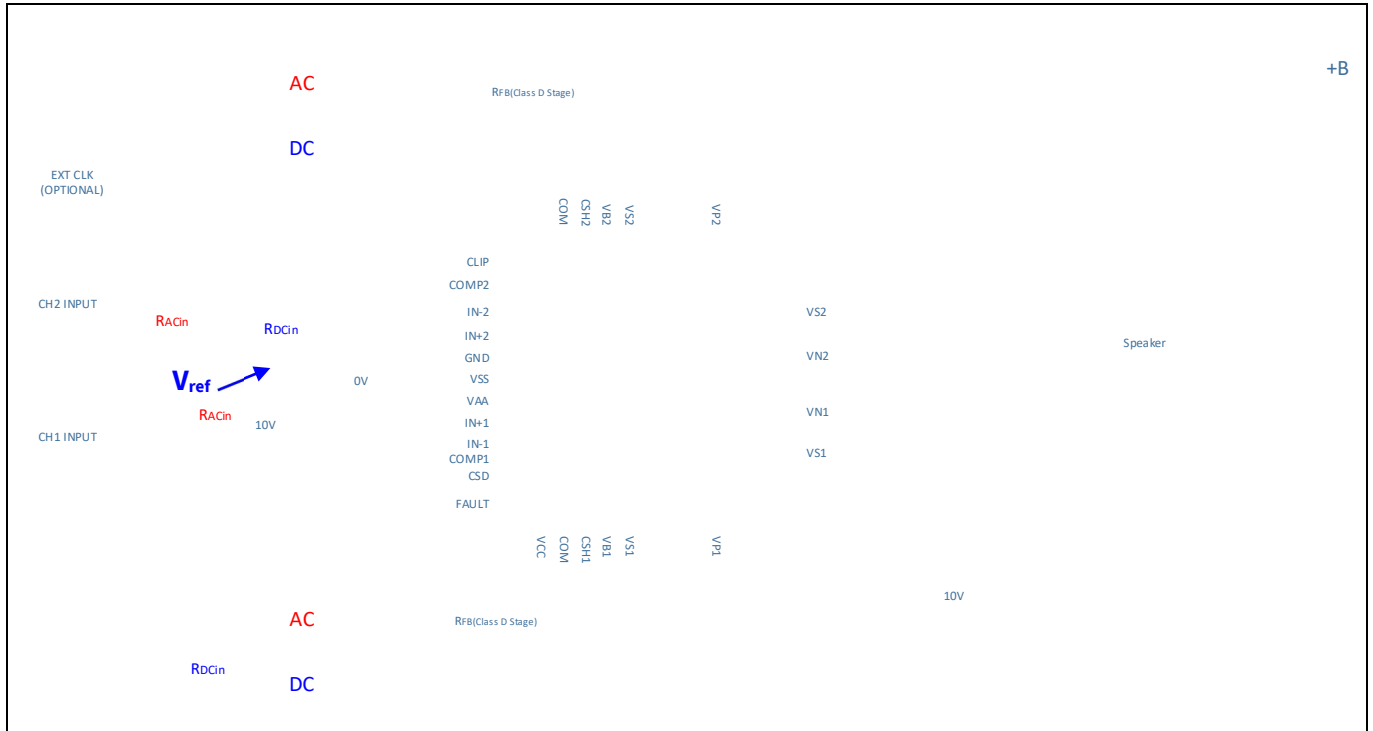

Figure 12 AC and DC path

9.1 Gain design flow

The gain design can follow Figure 13's gain design flow.

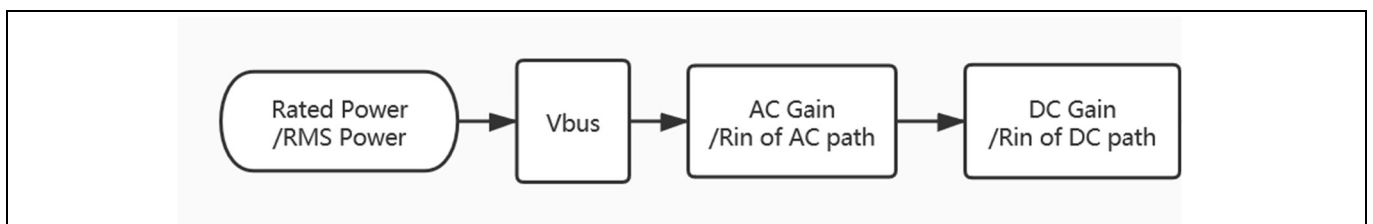

Figure 13 Gain design flow

- 1, Set target rated power and load impedance
- 2, Calculate V_{bus} based on rated power and load impedance.
- 3, Calculate required AC gain & R_{ACin} .
- 4, Calculate R_{DCin} .

9.2 Vbus Calculation

Vbus is calculated by the load impedance and clipping power (normally 75% of RMS power)

$$V_{bus} = (2 * P_{clipping} * R_{load})^{1/2} / M$$

M is maximum modulation index, normally M=90%

$$V_{bus} = (2 * 200 * 75\% * 4)^{1/2} * 90\%$$

$$= 38.5V$$

Use 40V as Vbus in this design.

9.3 AC gain setting:

AC gain is the mean ratio of the signal amplitude at the output to the amplitude at the input.

In REF_MA5332BTLSPS design, assume the maximum input signal is up to 5Vp-p balanced input.

Set the gain when input is 5Vp-p and the clipping voltage is 74Vp-p (93% of $V_{bus} * 2 = 40 * 2V$ for BTL).

Desire total voltage gain = $74/5 = 14.8$.

$$\text{Total Voltage Gain} = \text{Gain(OPAMP stage)} * \text{Gain(Class D stage)}$$

Set OPAMP gain to be maximum to have the get minimum noise floor. Set the OPAMP gain based on the supply of the OPAMP, which is 10V in this design. The maximum output of the OPAMP is 9.9V, which is decided by the parameter of the OPAMP.

So the maximum OPAMP's voltage gain is $9.9 / (1.414 * 2) = 3.5$.

$$\text{Gain(Class D stage)} = \text{Total Voltage Gain} / \text{Gain(OPAMP stage)}$$

$$= 14.8 / 3.5$$

$$= 4.3$$

In the current design preset below values:

$$R_{FB(OPAMP\ stage)} = R30 = 34.8\text{kohm}$$

$$R_{in(OPAMP\ stage)} = R15 = 10\text{kohm}$$

$$R_{FB(Class\ D\ stage)} = R135 = 47.5\text{kohm (recommend fix the value as 47.5kohm)}$$

$$R_{in(Class\ D\ stage)} = R31 + R3 = (3.3 + 8.2)\text{kohm}$$

$$\text{Total Voltage Gain} = \text{Gain(OPAMP stage)} * \text{Gain(Class D stage)}$$

$$= [R_{FB(OPAMP\ stage)} / R_{in(OPAMP\ stage)}] * [R_{FB(Class\ D\ stage)} / R_{in(Class\ D\ stage)}]$$

$$= (R30 / R15) * (R13 / (R31 + R3))$$

$$= (34.8 / 10) * (47.5 / (3.3 + 8.2))$$

$$= 3.48 * 4.13$$

$$= 14.37 \text{ (close to 14.8)}$$

$$\text{Gain(dB)} = 20 * \log(14.37) = 23.15\text{dB}$$

9.4 DC gain setting:

DC gain is to set the output DC operation point at half of the Vbus.

Output DC operation point = $\frac{1}{2} * V_{bus} = V_{ref} * DC \text{ gain}$

$V_{ref} = \frac{1}{2} * V_{AA}$

DC gain = $\frac{1}{2} * V_{bus} / V_{ref}$

$$= (R_{FB(\text{Class D stage})} + R_{DCin}) / R_{DCin}$$

With $R_{FB(\text{Class D stage})} = 47.5 \text{ kohm}$

$R_{FB(\text{Class D stage})} / R_{DCin} = (\frac{1}{2} * V_{bus} / 2 - V_{ref}) / V_{ref}$

$$\Rightarrow R_{DCin} = R_{FB(\text{Class D stage})} * V_{ref} / (\frac{1}{2} * V_{bus} - V_{ref})$$

$$R7 = R8 = R3 * 5 / (V_{bus} / 2 - 5) = 47.5 * 5 / (40 / 2 - 5) = 15.8 \text{ kohm}$$

10 Schematic

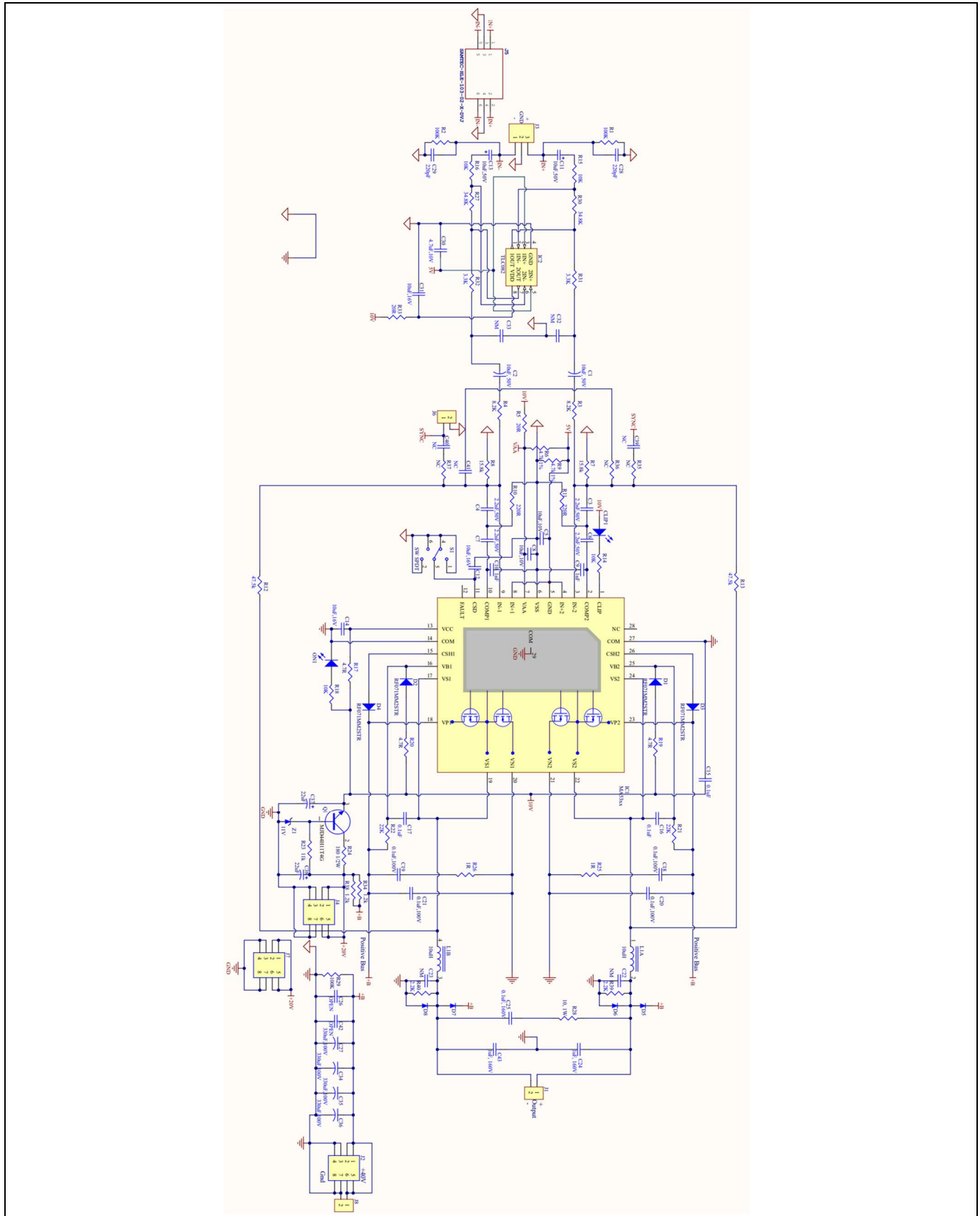

Figure 14 Schematic

11 PCB

11.1 PCB specification

1. Two-layer SMT PCB with through-holes
2. 1/16 thickness
3. 2/0 oz. Cu
4. FR4 material
5. 10 mil lines and spaces
6. Solder mask to be green enamel EMP110 DBG (CARAPACE) or Enthone endplate DSR-3241 or equivalent
7. Silkscreen to be white epoxy non-conductive per IPC-RB 276 standard
8. All exposed copper must be finished with tin-lead Sn 60 or 63 for 100 μ inches thick
9. Tolerance of PCB size shall be 0.010 to 0.000 inches
10. Tolerance of all holes is +/- 0.003 inches
11. PCB acceptance criteria as defined for class II PCB standards

11.2 PCB layout

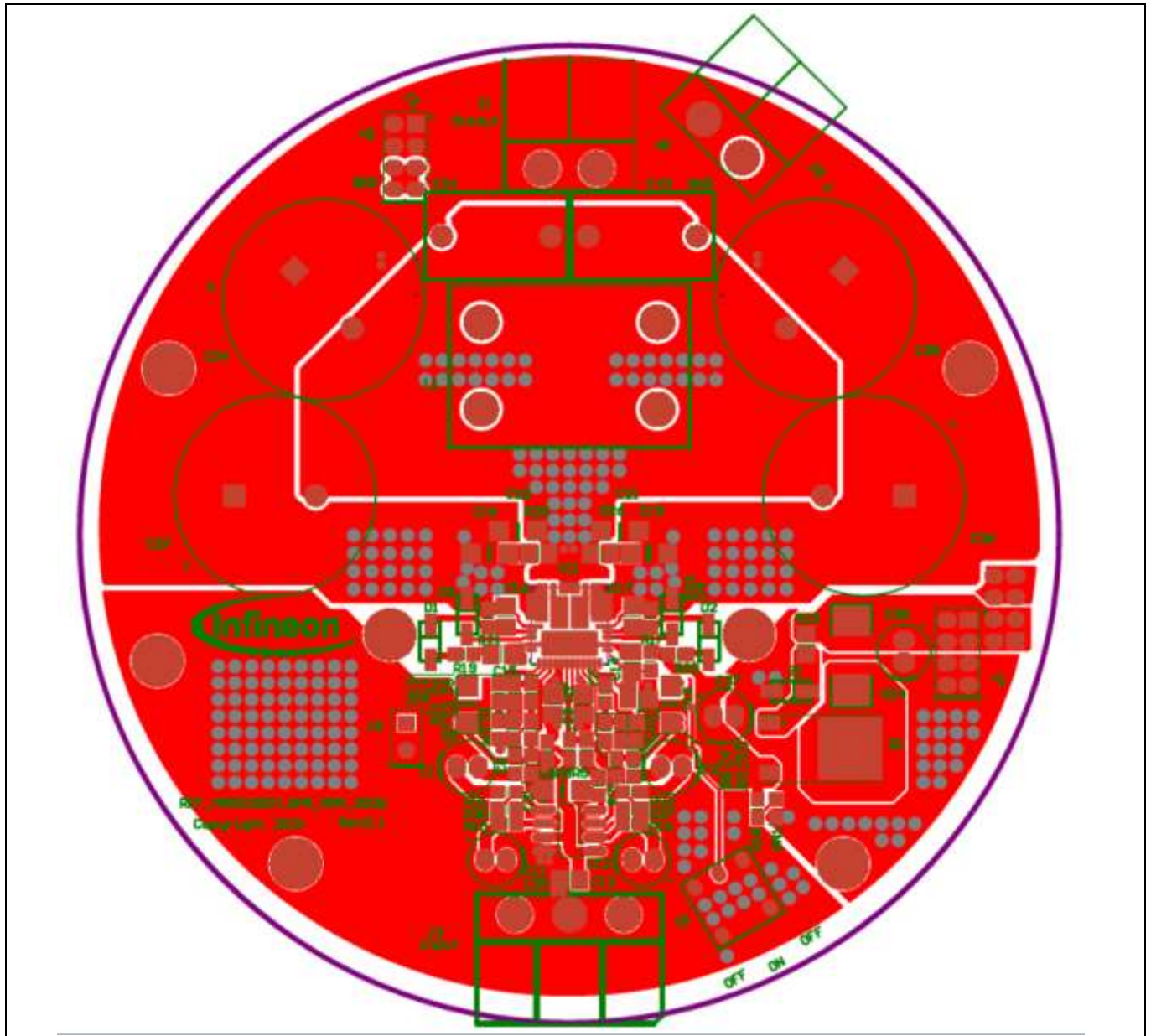

Figure 15 Board top view

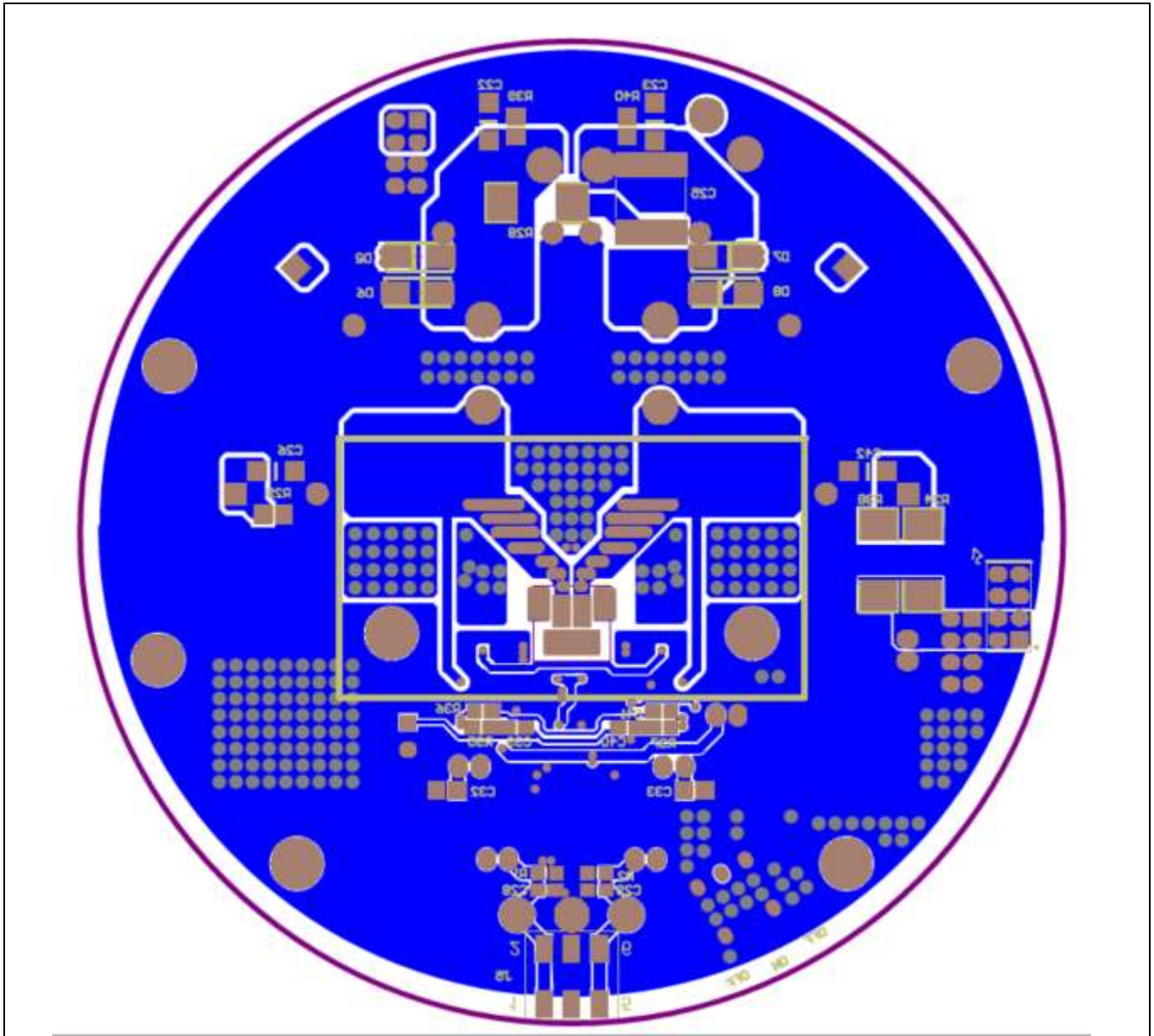

Figure 16 Board bottom view

12 Bill of Materials (BOM)

Table 5 Board BOM

No.	Part number	Designator	Description	Quantity	Vendor
1	565-1106-ND	C1, C2, C11, C13	CAP ALUM 10UF 20% 50V RADIAL	4	Digikey
2	490-1500-1-ND	C3, C4, C6, C7	CAP CER 2200PF 50V 10% X7R 0603	4	Digikey
3	587-2668-1-ND	C5, C8	CAP CER 10UF 10V X7R 10% 0805	2	Digikey
4	399-1082-1-ND	C9, C10	CAP 1000PF 50V CERAMICX7R 0603	2	Digikey
5	490-5519-1-ND	C12, C14	CAP CER 10UF 16V X6S 0805	2	Digikey
6	445-1418-1-ND	C15, C16, C17	CAP CER .10UF 100V X7R 10% 0805	3	Digikey
7	445-1377-1-ND	C18, C19, C20, C21	CAP CER .1UF 100V X7R 10% 1206	4	Digikey
8	495-4721-ND	C24, C43	CAP FILM 1UF 10% 450VDC RADIAL	2	Digikey
9	1928-1956-1-ND	C25	CAP FILM 0.1UF 20% 250VDC 2824	1	Digikey
10	URS2A331MHD	C27, C34, C35, C36	CAP ALUM 330UF 20% 100V RADIAL	4	Digikey
11	490-1483-1-ND	C28, C29	CAP CER 220PF 50V X7R 0603	2	Digikey
12	478-1429-1-ND	C30	CAP CER 4.7UF 10V Y5V 0805	1	Digikey
13	445-1601-1-ND	C31	CAP CER 10UF 16V X7R 1206	1	Digikey
14	565-1056-ND	C37, C38	CAP ALUM 22UF 20% 25V RADIAL, CAP 22UF 25V ELECT VR RADIAL	2	Digikey
15	160-1183-1-ND	CLIP1	LED GREEN CLEAR 0603 SMD	1	Digikey
16	RF071MM2SCT-ND	D1, D2, D3, D4	DIODE SWITCH 100V 400MW SOD123	4	Digikey
17	MURA120T3GOSCT-ND	D5, D6, D7, D8	DIODE GEN PURP 200V 2A SMA	4	Digikey
18	MA5332MS	IC1	2 CH Integrated Digital Audio Amplifier	1	Infineon
19	296-2421-1-ND	IC2	IC OPAMP GP 2 CIRCUIT 8SOIC	1	Digikey

200 W class D amplifier

No.	Part number	Designator	Description	Quantity	Vendor
20	ED2779-ND	J1',J8'	2 Position Terminal Block Plug	2	Digikey
21	ED2779-ND	J1',J8'	2 Position Terminal Block Plug	2	Digikey
22	A98249-ND	J3	TERM BLOCK HDR 3POS 90DEG 5MM	1	Digikey
23	A113286-ND	J3'	TERM BLOCK PLUG 3POS STR 5MM	1	Digikey
24	CPD1521C-100M	L1	2 in 1 10uH inductor	1	CODACA
25	160-1646-1-ND	ON1	LED 468NM BLUE CLEAR 0603 SMD	1	Digikey
26	MJD44H11T4GOSCT-ND	Q1	TRANS NPN EPITAX 100V 3A TO-220	1	Digikey or Mouser
27	RHM100KGCT-ND	R1, R2	RES SMD 100K OHM 5% 1/10W 0603	2	Digikey
28	CR0603-FX-8201ELFCT-ND	R3, R4	RES SMD 8.2K OHM 1% 1/10W 0603	2	Digikey
29	RMCF0603JT10R0CT-ND	R5, R33	RES 10 OHM 1/10W 5% 0603 SMD,	2	Digikey
30	311-4.70KHRCT-ND	R6, R9	RES SMD 4.7K OHM 1% 1/10W 0603	2	Digikey
31	RMCF0603FT15K8CT-ND	R7, R8	RES 15.8K OHM 1% 1/10W 0603	2	Digikey
32	YAG3652CT-ND	R10, R11	RES 220 OHM 1/10W 5% 0603 SMD, RES 620 OHM 1/10W 5% 0603 SMD	2	Digikey
33	311-47.5KFRCT-ND	R12, R13	RES SMD 47.5K OHM 1% 1/4W 1206	2	Digikey
34	RHM10KGCT-ND	R14, R15, R16, R18	RES 10K OHM 1/10W 5% 0603 SMD	4	Digikey
35	RMCF0603JT4R70CT-ND	R17, R19, R20	RES TF 1/10W 4.7 OHM 5% 0603	3	Digikey
36	RMCF0603JT22K0CT-ND	R21, R22	RES 22K OHM 5% 1/10W 0603	2	Digikey
37	RNCP0805FTD11K0CT-ND	R23	RES 11K OHM 1% 1/4W 0805	1	Digikey
38	RMCF2512JT180RCT-ND	R24	AXIAL RES 1.0K OHM 1W 5% METAL OXIDE	1	Digikey
39	311-1.0ARCT-ND	R25, R26	RES 1.0 OHM 1/8W 5% 0805 SMD	2	Digikey
40	RMCF0603FT34K8CT-ND	R27, R30	RES 34.8K OHM 1% 1/10W 0603	2	Digikey
41	PT10XCT-ND	R28	RES SMD 10 OHM 5% 1W 2512	1	Digikey

REF_MA5332BTLSPS
MA5332MS reference board



200 W class D amplifier

No.	Part number	Designator	Description	Quantity	Vendor
42	311-100KCRCT-ND	R29	RES SMD 100K OHM 1% 1/8W 0805	1	Digikey
43	RHM3.3KGCT-ND	R31, R32	RES SMD 3.3K OHM 5% 1/10W 0603	2	Digikey
44	RMCF2512JT1K20CT-ND	R34, R38	RES 1.2K OHM 5% 1W 2512	2	Digikey
45	RMCF0805JT2K20CT-ND	R39, R40	RES 2.2K OHM 5% 1/8W 0805	2	Digikey
46	360-1757-ND	S1	SWITCH TOGGLE SPDT 0.4VA 28V	1	Digikey
47	BZT52C11-FDICT-ND	Z1	DIODE ZENER 11V 500MW SOD123	1	Digikey
48	8401K-ND	1/2" Standoffs 4-40	HEX STANDOFF #4-40 ALUMINUM 1/2"	5	Digikey
49	H724-ND	4-40 Nut	NUT HEX 4-40 STAINLESS STEEL	5	Digikey
50	H729-ND	No. 4 Lock Washer	WASHER LOCK INTERNAL #4 SS	5	Digikey
51	Heatsink	Heatsink	1560*970*406.57(mil)	1	-
52	BER161-ND	Thermal pad	Thermal pad	1/8	Digikey
53	screws	-		2	-

Note: **Heatsink is an option for AMP*

depends on holes on the heatsink

Note: *25 to deliver higher power*

Revision history

Document version	Date of release	Description of changes
V 1.0	2021-03-07	Initial release
V 1.1	2021-07-19	Changed part number MA5332 --> MA5332MS
V 1.2	2023-05-16	Updated schematic with high resolution image

Trademarks

All referenced product or service names and trademarks are the property of their respective owners.

Edition 2020-07-07

Published by

Infineon Technologies AG

81726 Munich, Germany

© 2023 Infineon Technologies AG.

All Rights Reserved.

Do you have a question about this document?

Email: erratum@infineon.com

Document reference

UM_1904_PL88_1910_133036

IMPORTANT NOTICE

The information given in this document shall in no event be regarded as a guarantee of conditions or characteristics ("Beschaffheitsgarantie").

With respect to any examples, hints or any typical values stated herein and/or any information regarding the application of the product, Infineon Technologies hereby disclaims any and all warranties and liabilities of any kind, including without limitation warranties of non-infringement of intellectual property rights of any third party.

In addition, any information given in this document is subject to customer's compliance with its obligations stated in this document and any applicable legal requirements, norms and standards concerning customer's products and any use of the product of Infineon Technologies in customer's applications.

The data contained in this document is exclusively intended for technically trained staff. It is the responsibility of customer's technical departments to evaluate the suitability of the product for the intended application and the completeness of the product information given in this document with respect to such application.

For further information on the product, technology delivery terms and conditions and prices please contact your nearest Infineon Technologies office (www.infineon.com).

WARNINGS

Due to technical requirements products may contain dangerous substances. For information on the types in question please contact your nearest Infineon Technologies office.

Except as otherwise explicitly approved by Infineon Technologies in a written document signed by authorized representatives of Infineon Technologies, Infineon Technologies' products may not be used in any applications where a failure of the product or any consequences of the use thereof reasonably be expected to result in personal injury.