

Mechanical Dimensions: Inches [mm]

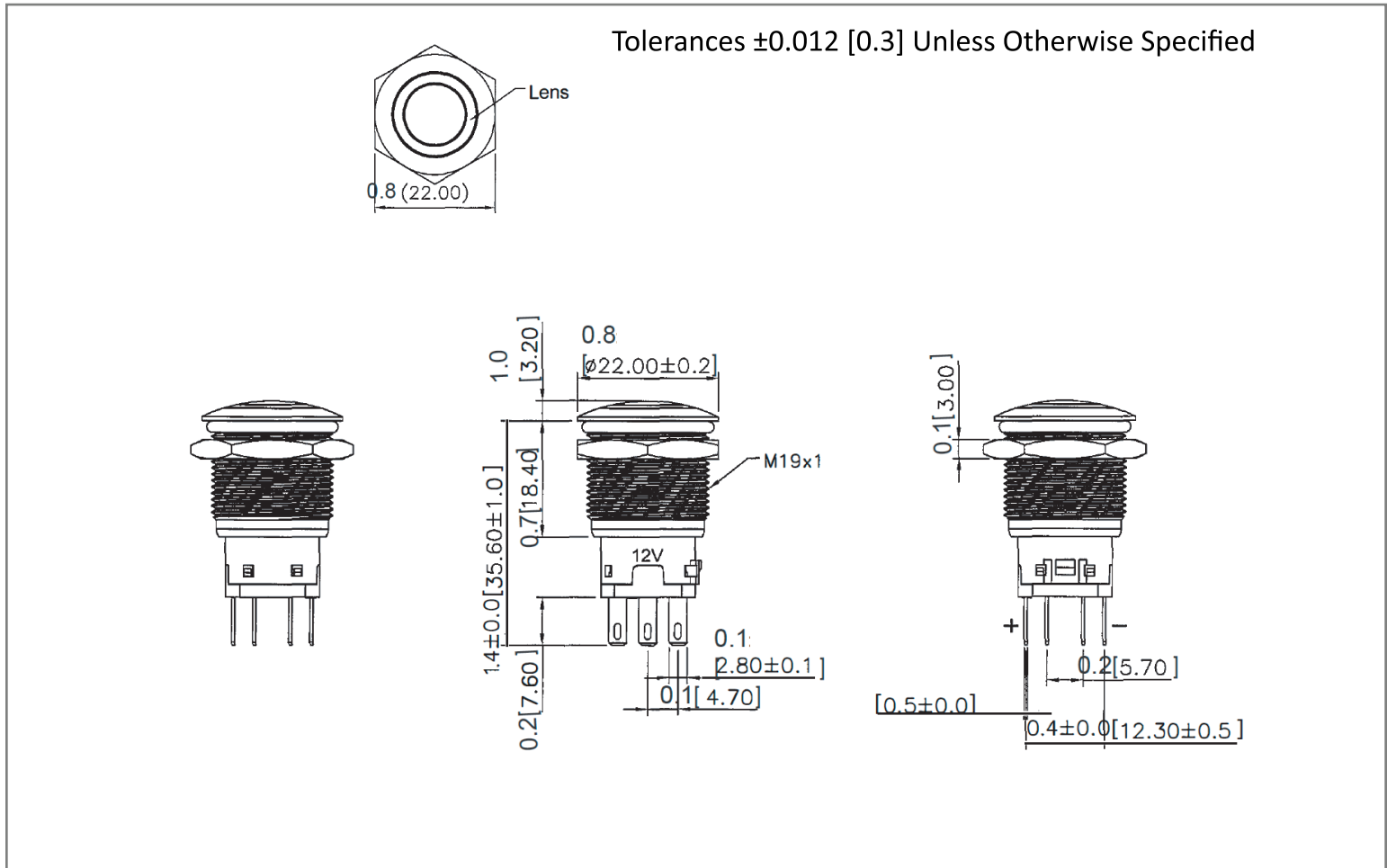

Mounting Hole

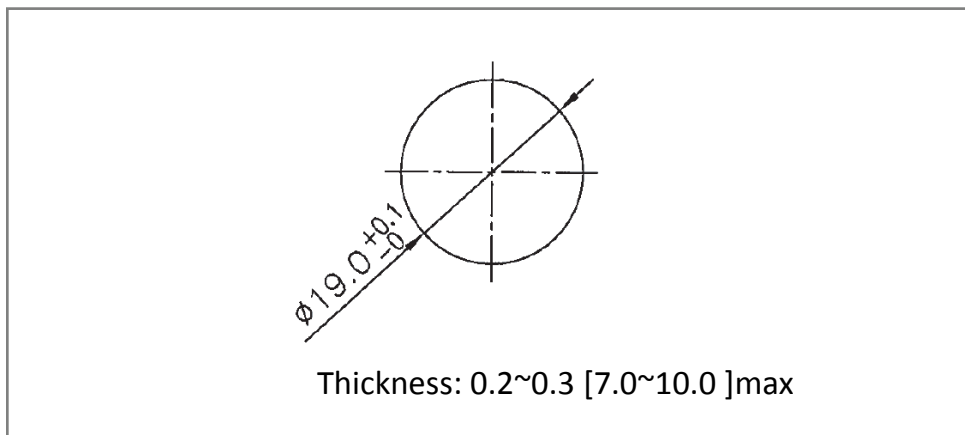

Circuit Diagram

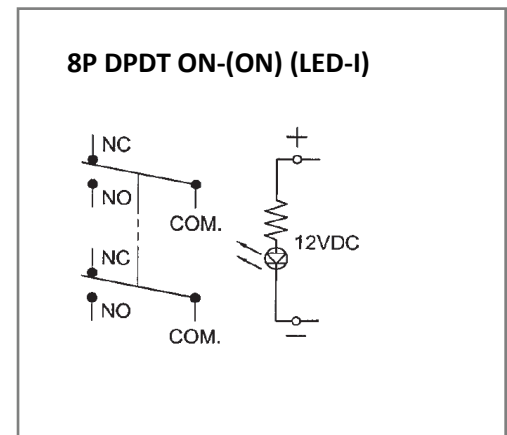

Electrical Specifications

Rating	10A 14V DC
Contact Resistance	50m ohm Max
Insulation Resistance	DC 500V 100M ohm Min
Dielectric Strength	AC 500V 1 minute
Operation Temperature	-20°C ~ 70°C

Material Specifications

Frame	SUS304
Lamp	Red
Actuator	SUS304, LENS Red Clear, PC
Housing	Black, PA 66
Bottom	Black, PBT +15%GF

Rev	Date of issue	Revision Notes	Designed	Approved
A	02-28-2019	Initial Drawing	RC	OH