

Medical

FEATURES AND BENEFITS

2" x 4" x 1.3" Package

Approved to EN/CSA/IEC/UL62368-1

For 1U Applications

2 x MOPP Input to Output Isolation

150W w/air, 100W Convection Cooled

3 Year Warranty

Universal Input 90VAC–264VAC

RoHS Compliant

Power Fail/Output Good Signal



MODEL SELECTION

Model Number	Volts	Output Current		Ripple & Noise**	Total Regulation	OVP Threshold**
		w/200LFM air	Convection*			
MINT1150A1206K01	12V	12.5A	8.33A	0.5%RMS, 1.2% pk-pk	±5%	14.0 ± 1.1V
MINT1150A1506K01	15V	10.0A	6.67A	0.5%RMS, 1.0% pk-pk	±5%	18.0 ± 1.5V
MINT1150A2406K01	24V	6.25A	4.17A	0.5%RMS, 1.0% pk-pk	±5%	28.0 ± 2.5V
MINT1150A4806K01	48V	3.13A	2.08A	0.5%RMS, 1.0% pk-pk	±5%	55.0 ± 4.0V
MINT1150A5606K01	56V	2.68A	1.79A	0.5%RMS, 1.0% pk-pk	±5%	<59.9V

Notes:

- * Maximum output power is 95 Watts for input voltage of 90VAC–105VAC at 50°C convection. For input voltage of 105VAC or more, the total power is 100 Watts at 50°C convection.
- ** Measured with noise probe directly across output terminals, and load terminated with 0.1µF ceramic and 10µF low ESR capacitors.



INPUT

AC Input	100VAC–240VAC, ±10%, 47Hz–63Hz, 1 ϕ , 120Vdc–370Vdc
Input Current	115VAC: 2A, 230VAC: 1A
Inrush Current	264VAC, cold start: will not exceed 50A
Input Fuses	F1, F2: 4A, 250VAC fuses provided on all models
Earth Leakage Current	<300 μ A@264VAC, 60Hz, NC
Efficiency	89% typical at 115VAC

RELIABILITY

MTBF	640,000 hours at 100W convection, 1,500,000 hours at 150W with 200LFM air
------	---

SAFETY

Safety Standards	EN/CSA/IEC/UL62368-1
------------------	----------------------

PROTECTION

Oversoltage Protection	OVP firing reduces output voltage to <50% of nominal in <50mS. See chart for trip range
Short Circuit Protection	Provided - no damage will occur if the output is shorted. Hiccup Mode
Overload Protection	Hiccup Mode

ISOLATION

Isolation	Input-Output: 4000VAC, 2 x MOPP Input-Ground: 1800VAC, 1 x MOPP Output-Ground: 1500VAC
-----------	--

OUTPUT

Output Voltage	See chart
Output Power	150W continuous, with 200 lfm airflow, 100W convection cooled – See chart for specific voltage model ratings
Turn On Time	Less than 2 sec. @115VAC (inversely proportional to input voltage and thermistor temperature)
Hold-up Time	>12mS at full load, 120VAC
Ripple and Noise	See chart
Total Regulation	±5%. See chart
Switching Frequency	PFC: Variable, 30kHz–400kHz Main Converter: Variable 30kHz–180kHz, 65Hz–70kHz at full load
Minimum Load	Not required
Transient Response	50% load step. $\Delta i/\Delta t$: <0.2A/ μ S Max Volt Deviation = 3%
Voltage Adjustability	±5% from nominal

AUXILIARY SIGNALS

DC OK	Open collector logic signal goes and stays HIGH 100mS to 500mS after main output reaches regulation
AC Power Fail	During normal operations, stays HIGH
Power Fail	Goes LOW with 5 mS warning before loss of output power due to AC failure
Signals	AC Power Fail, DC OK



ENVIRONMENT

Operating Temperature	-10°C to +70°C
Relative Humidity	5% to 95%, non-condensing
Weight	183 grams
Dimensions	W: 2.0" x L: 4.0" x H: 1.3"
Altitude	Operating: -500 ft to 10,000 ft. Non-operating: -500 ft to 40,000 ft.
Storage Temperature	-40°C to +85°C
Vibration	Operating: 0.003g ² /Hz, 1.5grms overall, 3 axes, 10 min/axis Non-Operating: 0.026g ² /Hz, 5.0grms overall, 3 axes, 1 hr/axis
Shock	Operating: Half-sine, 20gpk, 10ms, 3 axes, 6 shocks total Non-Operating: Half-sine, 40 gpk, 10ms, 3 axes, 6 shocks total
Temperature Derating	Derate output power linearly above 50°C to 50% at 70°C

EMI/EMC COMPLIANCE

Conducted Emissions	EN55011/22 Class B, FCC Part 15, Subpart B, Class B
Radiated Emissions	EN55011/22 Class A; FCC Part 15, Subpart B, Class A w/6db margin
Static Discharge Immunity	EN61000-4-2, 6kV Contact Discharge, 8kV air discharge
Radiated RF Immunity	EN61000-4-3, 3V/m, Criteria A
EFT/Burst Immunity	EN61000-4-4, 2kV/5kHz, Criteria A
Line Surge Immunity	EN61000-4-5, 1kV differential, 2kV common-mode, Criteria A
Conducted RF Immunity	EN61000-4-6, 3Vrms, Criteria A
Power Frequency Magnetic Field Immunity	EN61000-4-8, 3A/m, Criteria A
Voltage Dip Immunity	EN61000-4-11, 0% Vin, 0.5cycle; 40% Vin, 5 cycles; 70% Vin, 25 cycles; Criteria A
Line Harmonic Emissions	EN61000-3-2, Class A, B, C, & D
Flicker Test	EN61000-3-3, Complies (dmax<6%)

MECHANICAL DRAWINGS

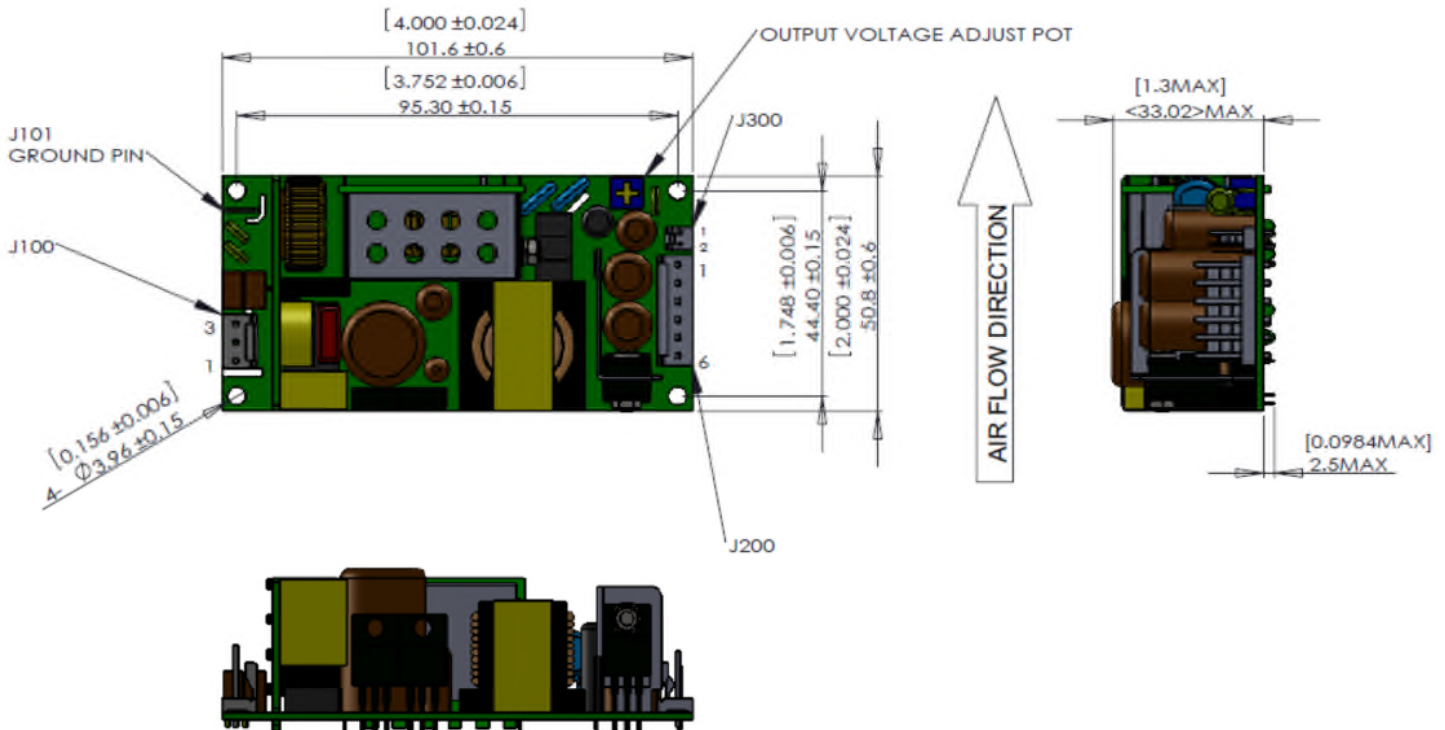



CONNECTOR INFORMATION

Input Connector J100	Ground J101	DC Output Connector J200	Signal Connector J300
PIN 1) AC LINE PIN 2) EMPTY PIN 3) AC NEUTRAL	0.187" FASTON TAB	PIN 1) +Vout PIN 2) +Vout PIN 3) +Vout PIN 4) -Vout PIN 5) -Vout PIN 6) -Vout	PIN 1) PF/DC OK PIN 2) Common
Mating Connector: Molex 09-50-3031 Pins= 08-52-0072	Mating Connector: Molex 01-90020005	Mating Connector: AMP 640250-6 Pins = 640252-1	Mating Connector: Molex 1375820-2 Pins = 1375819

POWER FAIL/DC OK SIGNALS - J300

AC Power failure/DC OK

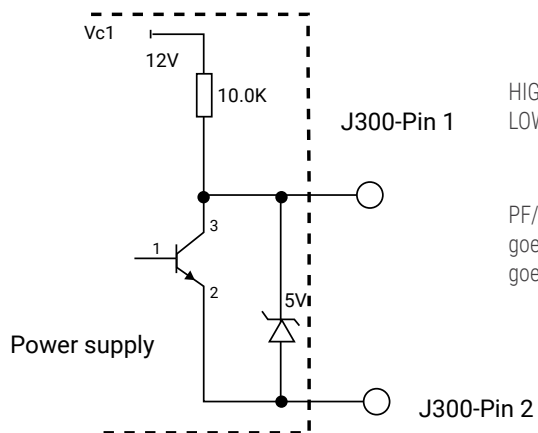

HIGH: 4V-5.2V
LOW: 0V-0.8V

PF/DC OK: During normal operation stays HIGH
goes HIGH 100-500 mS after main output
goes LOW with 5mS warning before loss of output from AC failure



AC Power failure and DC OK signals use the same pin, so the signals can be used as follows:

DC OK: Pin 2 = HIGH & Pin1 = HIGH

AC Power Failure: Pin 2 = LOW & Pin1 = LOW

AC Power Fail Signal

DC OK Signal

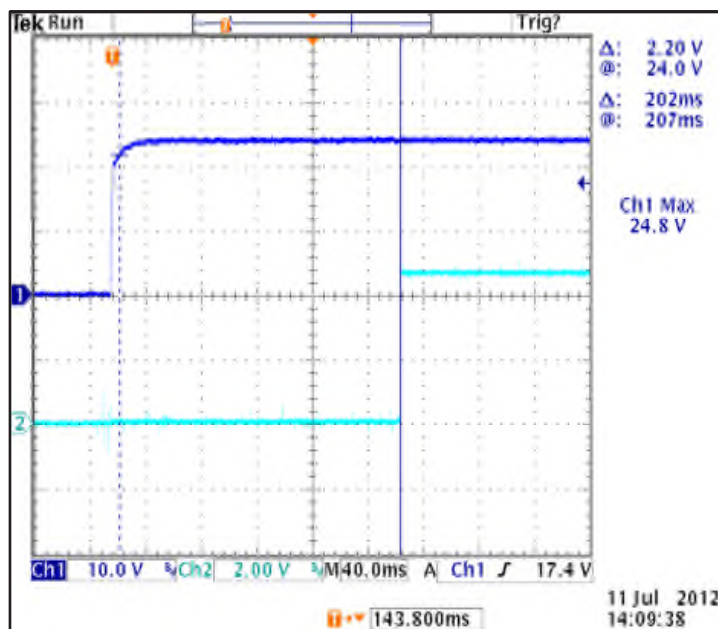
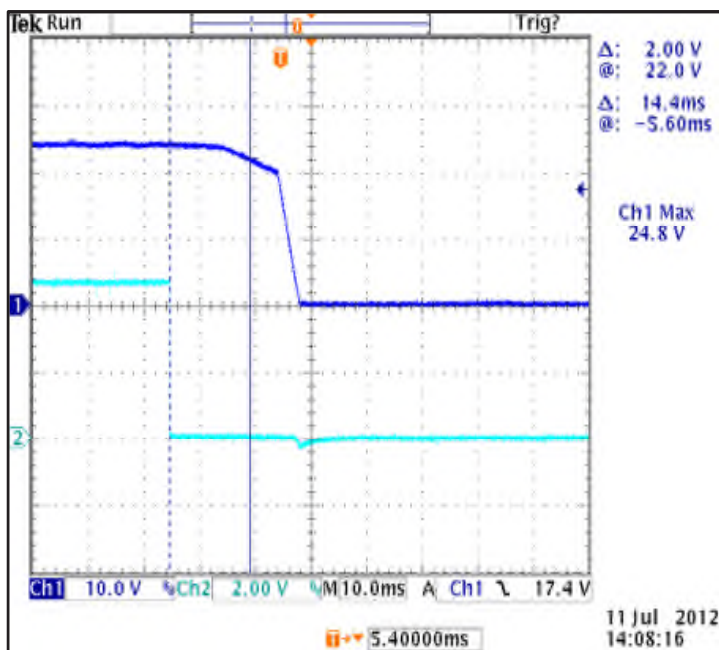

ISOLATION SPECIFICATIONS

Parameter	Conditions/Description	Min	Nom	Max	Units
Insulation Safety Rating	Input/Ground Input/Output Output/Ground		2 MOPP 1 MOPP N/A		
Electric Strength Test Voltage	Input/Ground Input/Output Output/Ground	1800 4000 1500	-	-	VAC VAC VAC



INPUT SPECIFICATIONS

Parameter	Conditions/Description	Min	Nom	Max	Units
Input Voltage		90	115/230	264	VAC
Turn-On Input Voltage	Ramping up		82.7		VAC
Turn-Off Input Voltage	Ramping down		67.0		VAC
Input Frequency		47	50/60	63	Hz
Inrush Current Limitation	264VAC, cold start	-	-	50	A
Power Factor	$V_{i\ nom} / I_{o\ nom}$	0.9	-	-	
Efficiency	$V_{i\ nom} / I_{o\ nom}$ MINT1150A1206K01 MINT1150A2406K01 MINT1150A4806K01 MINT1150A5606K01	-	89%	-	%

All specifications apply over specified input voltage, output load, and temperature range, unless otherwise noted.

PROTECTION

Parameter	Conditions/Description	Min	Nom	Max	Units
Input Fuse	Not user accessible				
Input Transient Protection	2KV(CM) and 1KV(DM) surge			2	KV(CM)
Output	No-load	Normal			
	Short circuit	Hiccup Mode			
	Overload	Hiccup Mode			
Overvoltage Protection	Latch style	See Models chart for trip ranges			
Over temperature Protection	Automatic power shutdown at TC =155°C				



CHARACTERISTIC CURVES

OUTPUT VS. TEMPERATURE

100W convection cooled and 150W continuous with 200 LFM airflow, Derating output power to 50% at 70°C.

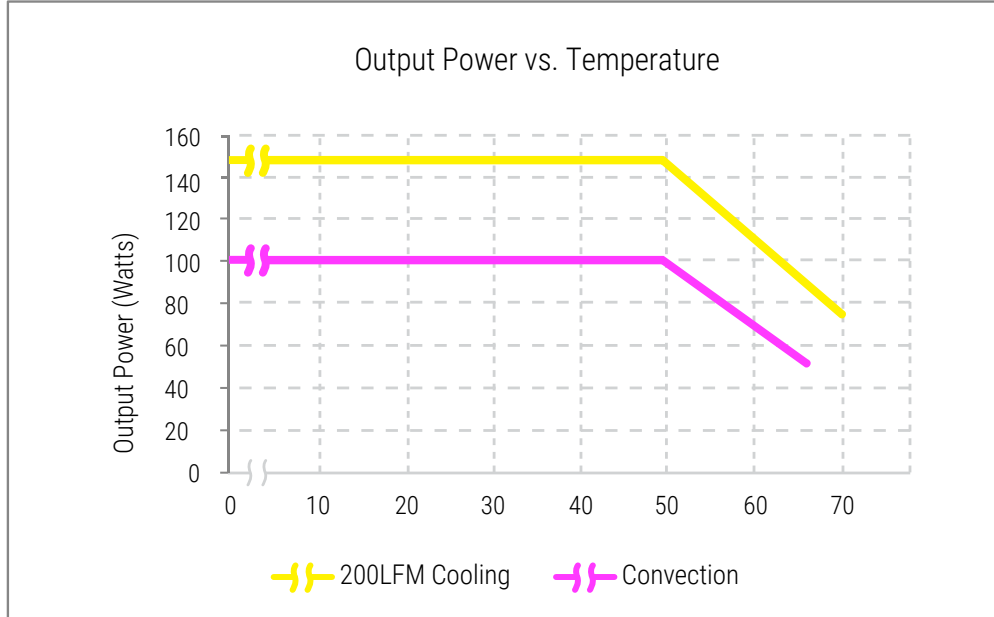

EFFICIENCY VS. LOADING

The high efficiency is achieved by using LLC technology, PFC topology minimizing switching losses. Synchronous MOSFET or SCHOTTKY diode is used as rectifier in MINT1150 family.

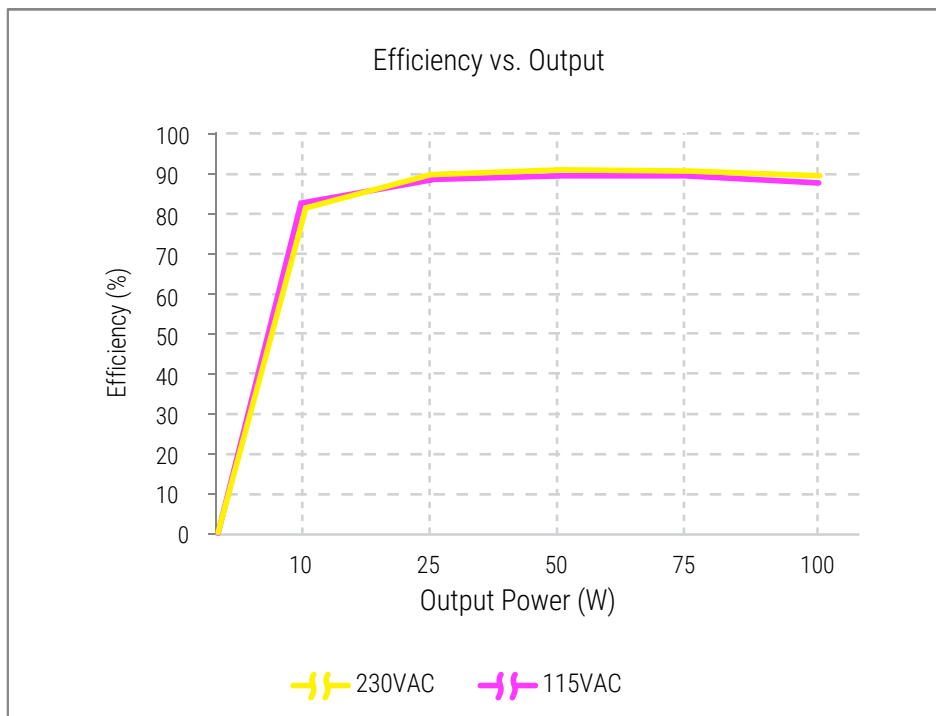



Ripple & Noise

To verify that the output ripple and noise does not exceed the level specified in the product specification, measured using a scope probe socket with 0.1uF ceramic and a 10uF electrolytic capacitor connected in parallel across it, 20MHz BW.

24V OUT, NO LOAD, 90VAC, 60HZ

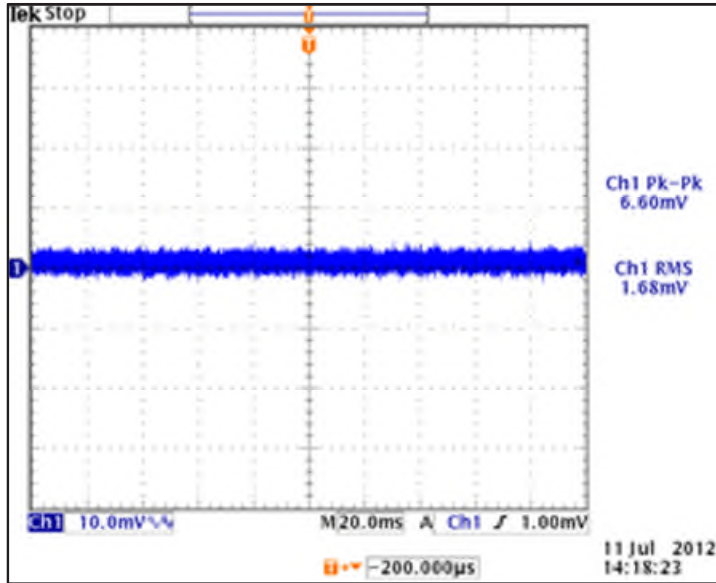

24V OUT, FULL LOAD, 90VAC, 60HZ

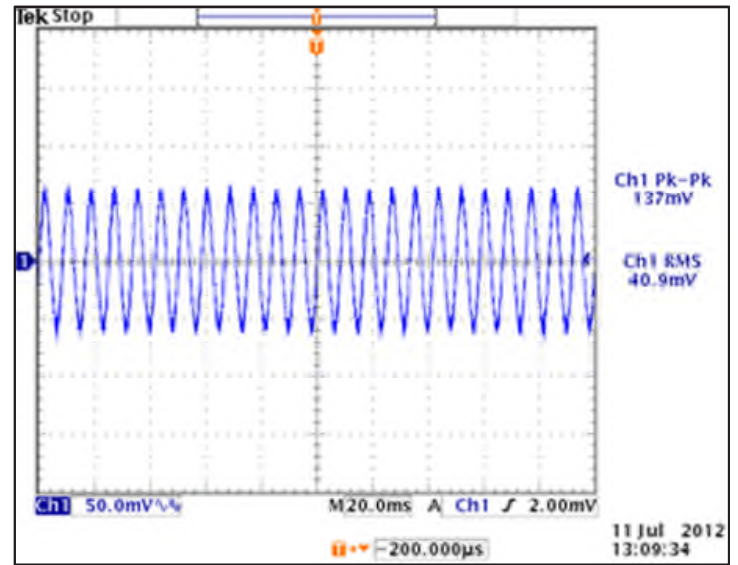

24V OUT, NO LOAD, 264VAC, 50HZ

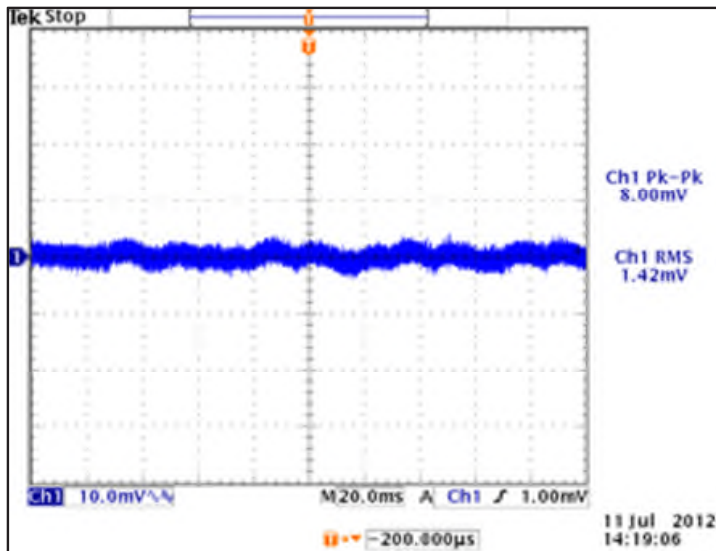

24V OUT, FULL LOAD, 264VAC, 50HZ

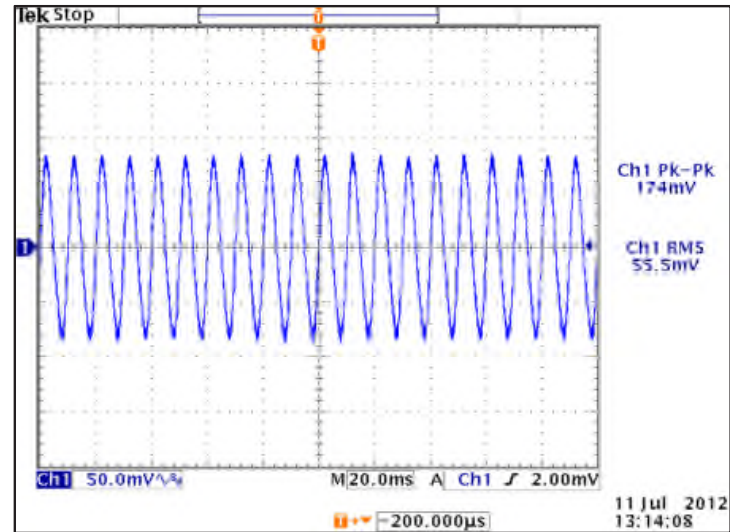



Output Transient Response

50% load step within the regulation limits of minimum and maximum load, $di/dt < 0.2A/\mu Sec$. Recovery time not specified as there is no laps in regulation with a 50% Load Step. Maximum voltage deviation is 3%, This test is performed on the MAIN OUTPUT ONLY.

24V OUT, 120VAC, 25% TO 75% LOAD STEP

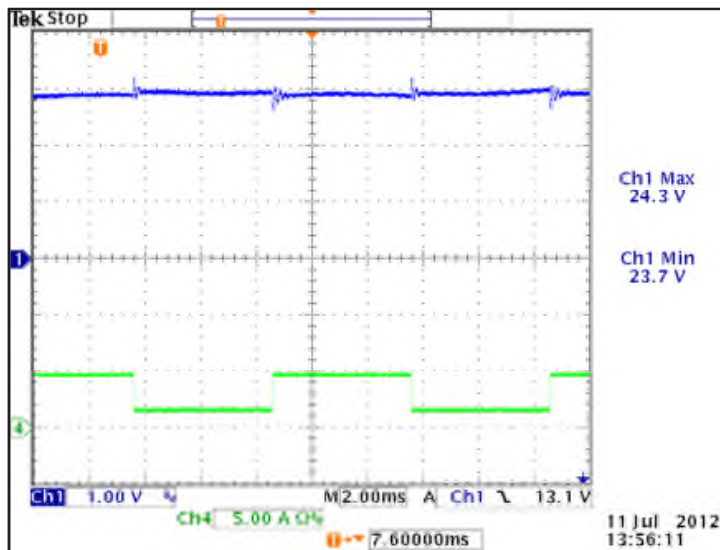

24V OUT, 240VAC, 25% TO 75% LOAD STEP

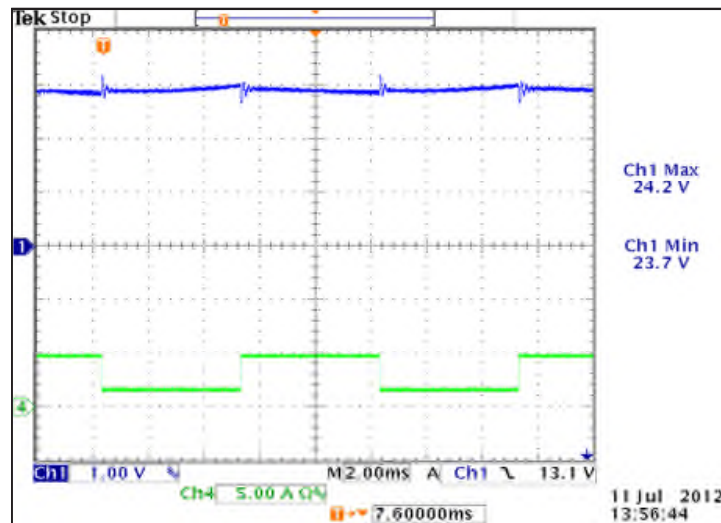

Output Overload Characteristic

Supply shall protect itself against Overload conditions. The Power Supply shall recover from Overload Conditions without operator intervention.

24V OUT, 90VAC

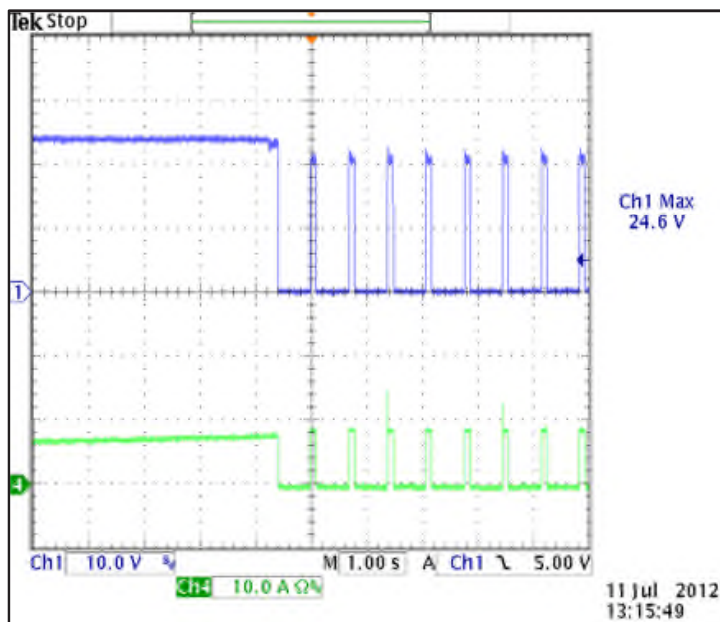

24V OUT, 264VAC

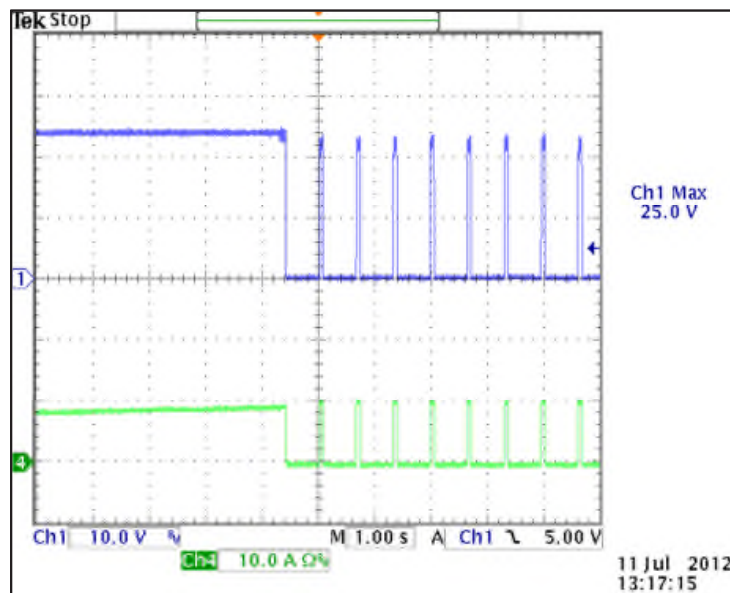



Short Circuit Protection

Supply shall protect itself against Short Circuit conditions. No damage will occur if the output is shorted.

24V OUT, 90VAC

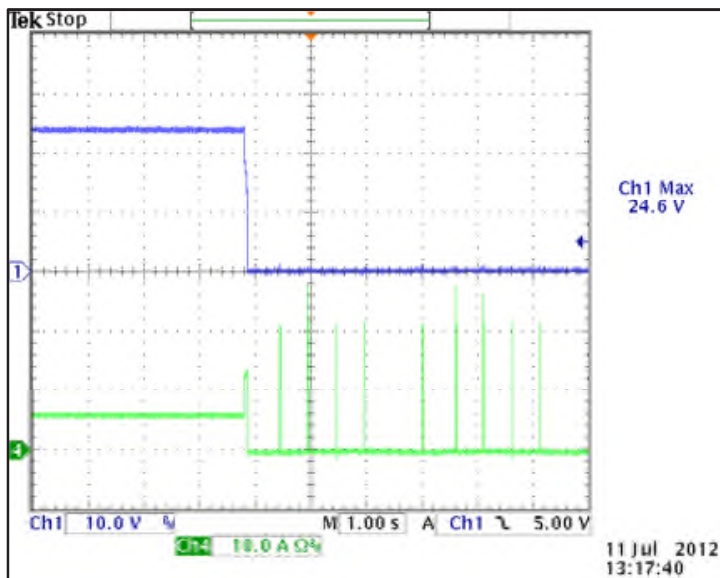

24V OUT, 264VAC

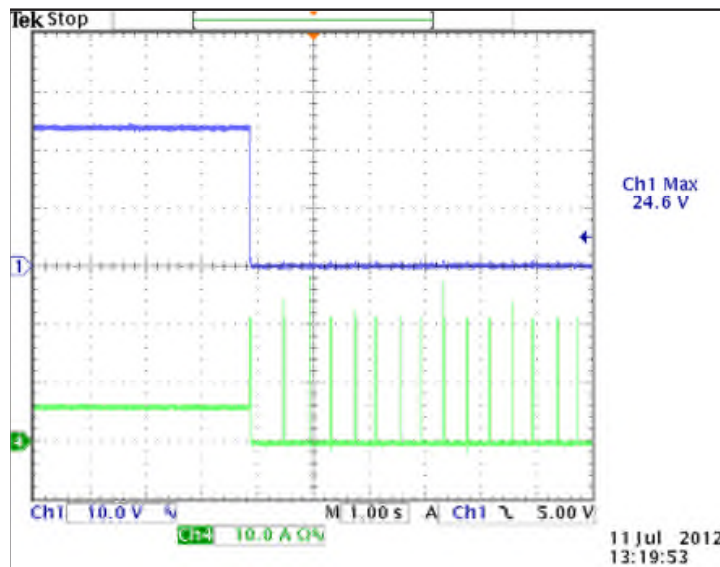

Overvoltage Protection

OVP firing reduces output voltage to <50% of nominal in <50ms. See models chart for trip ranges.

24V OUT, 90VAC

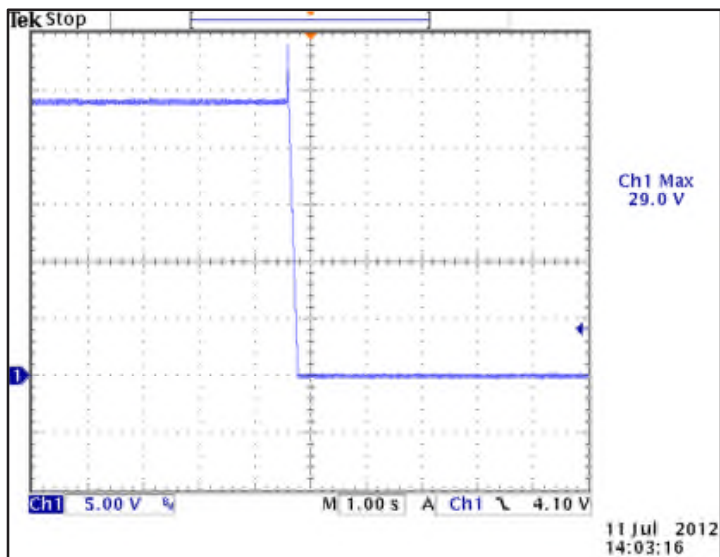



Turn On Time

90VAC, FULL LOAD

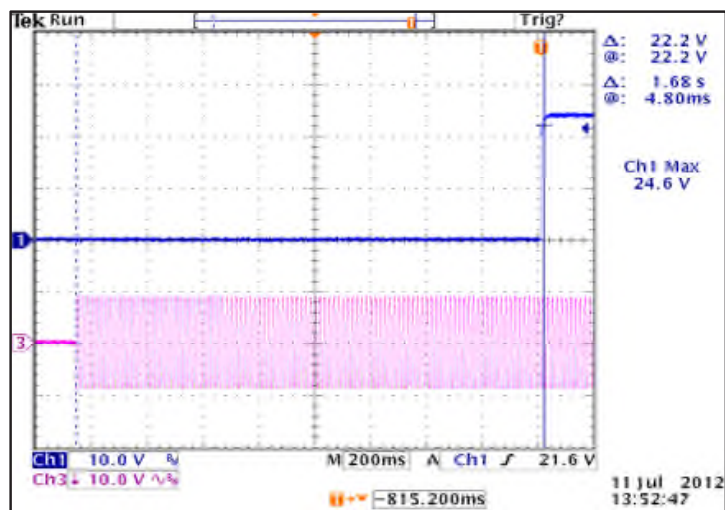

264VAC, FULL LOAD

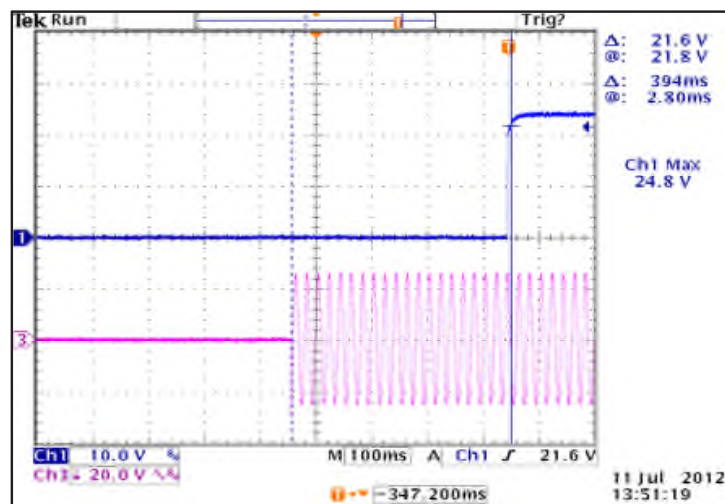

Hold Up Time

120VAC, FULL LOAD

