

## HEIDI-WR

~30° wide round shaped beam

### TECHNICAL SPECIFICATIONS:

Dimensions	Ø 21.6 mm
Height	11.7 mm
Fastening	tape, pin
Colour	clear
Box size	480 x 280 x 300 mm
Box weight	11.1 kg
Quantity in Box	3264 pcs
ROHS compliant	yes ⓘ



### MATERIAL SPECIFICATIONS:

Component	Type	Material	Colour
HEIDI-WR	Single lens	PMMA	clear
HEIDI-TAPE	Tape	PU tape	black

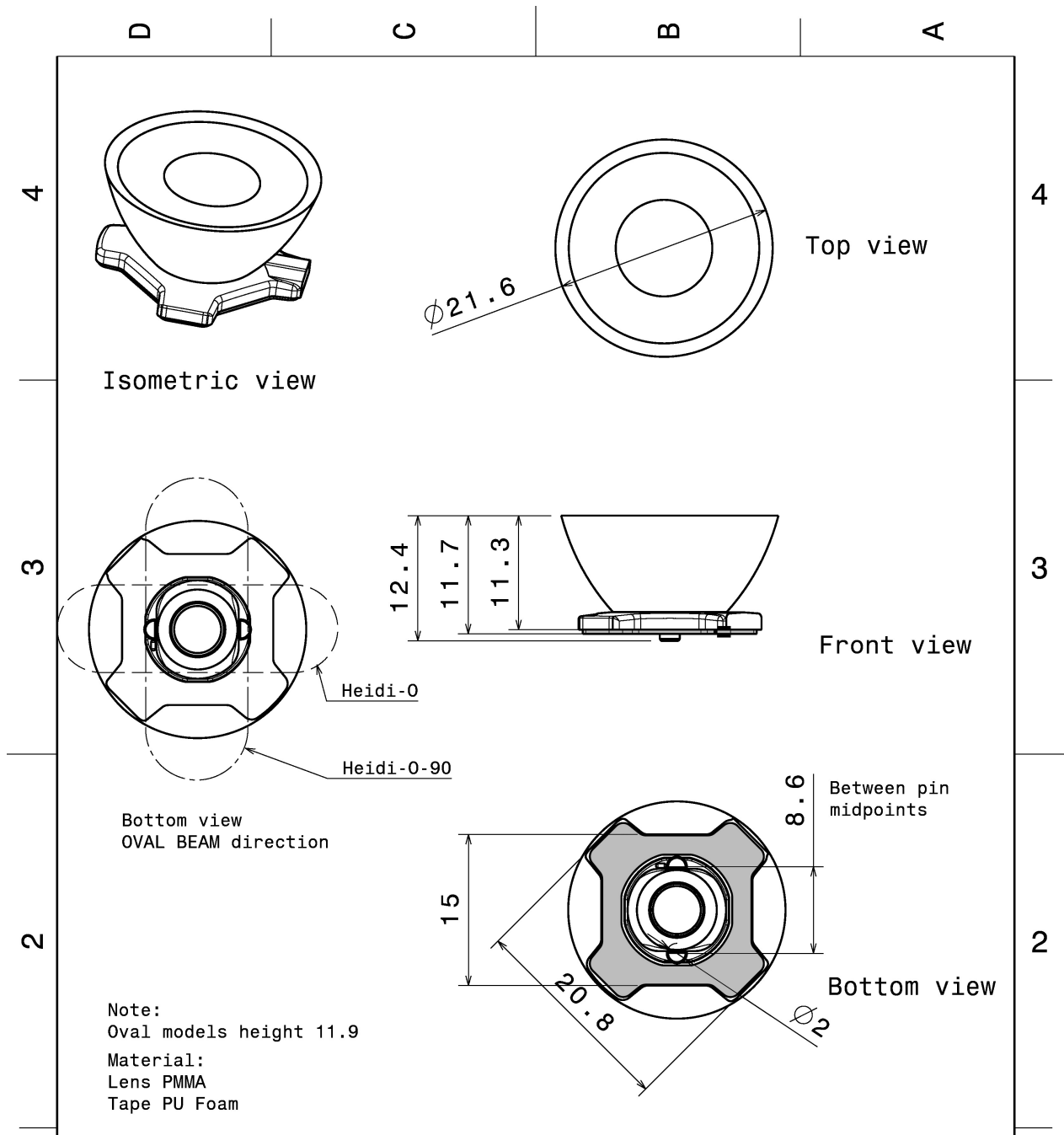

This drawing is our property. It can't be reproduced or communicated without our written agreement.		<b>LEDiL</b>		Ledil Oy Joensuunkatu 13 FIN-24100 SALO Finland	
<b>DRAWING TITLE</b>		<b>Datasheet Heidi-Series Assy</b>			
<b>DRAWN BY</b> ah	<b>DATE</b> 1.2.2012	<b>SIZE</b> A4	<b>DRAWING NUMBER</b>		<b>REV</b> 2
<b>CHECKED BY</b>	<b>DATE</b>	<b>SCALE</b> 2:1	<b>WEIGHT (g)</b>	<b>SHEET</b> 1/1	
<b>DESIGNED BY</b>	<b>DATE</b>				

### PHOTOMETRIC DATA (MEASURED):

#### CREE

LED XP-G  
FWHM 31.0°  
Efficiency %  
Peak intensity cd/lm  
LEDs/each optic 1  
Light colour White  
Required components:

#### CREE

LED XQ-E HD  
FWHM 25.0°  
Efficiency 94 %  
Peak intensity 4.300 cd/lm  
LEDs/each optic 1  
Light colour White  
Required components:

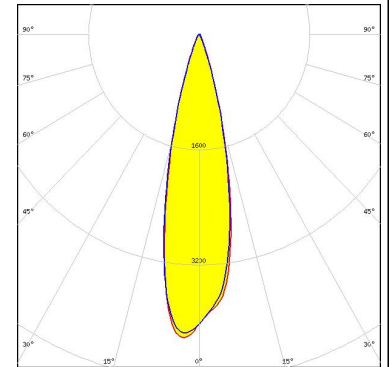

#### CREE

LED XQ-E HI  
FWHM 27.0°  
Efficiency 94 %  
Peak intensity 3.800 cd/lm  
LEDs/each optic 1  
Light colour White  
Required components:

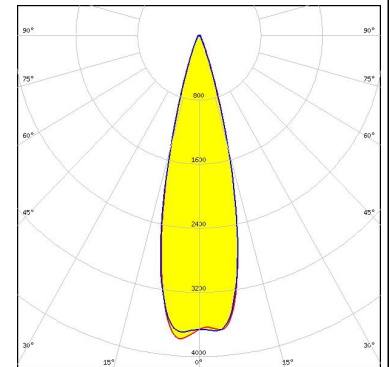

#### LUMILEDS

LED LUXEON Z ES  
FWHM 24.0°  
Efficiency 93 %  
Peak intensity 4.900 cd/lm  
LEDs/each optic 1  
Light colour White  
Required components:

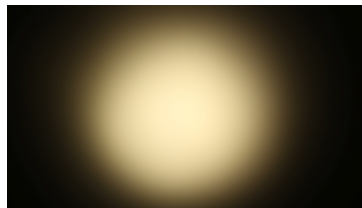

## PHOTOMETRIC DATA (MEASURED):



LED NVSxx19B/NVSxx19C  
FWHM 26.0°  
Efficiency 87 %  
Peak intensity 4.100 cd/m  
LEDs/each optic 1  
Light colour White  
Required components:



#### PHOTOMETRIC DATA (SIMULATED):



LED XP-G3  
 FWHM 32.0°  
 Efficiency 94 %  
 Peak intensity 3.070 cd/lm  
 LEDs/each optic 1  
 Light colour White  
 Required components:

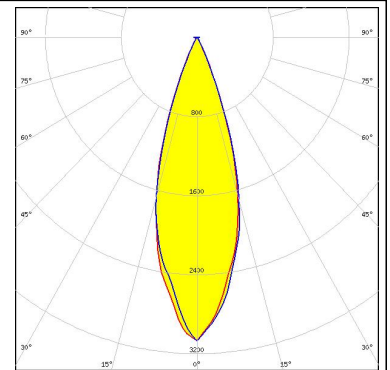

LED NVSxE21A  
 FWHM 17.0°  
 Efficiency 94 %  
 Peak intensity 8.642 cd/lm  
 LEDs/each optic 1  
 Light colour White  
 Required components:

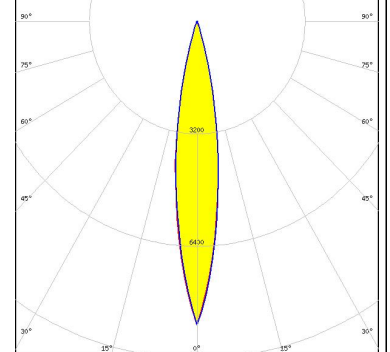

LED OSCONIQ P 3030  
 FWHM 24.0°  
 Efficiency 97 %  
 Peak intensity 5.465 cd/lm  
 LEDs/each optic 1  
 Light colour White  
 Required components:

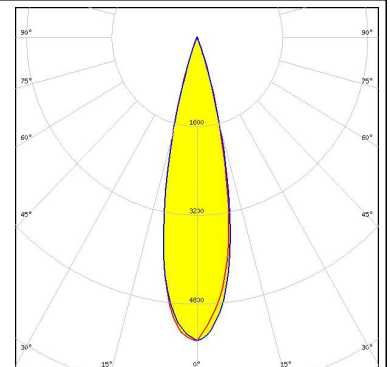

LED OSLOK Black  
 FWHM 20.0°  
 Efficiency 95 %  
 Peak intensity 6.600 cd/lm  
 LEDs/each optic 1  
 Light colour White  
 Required components:

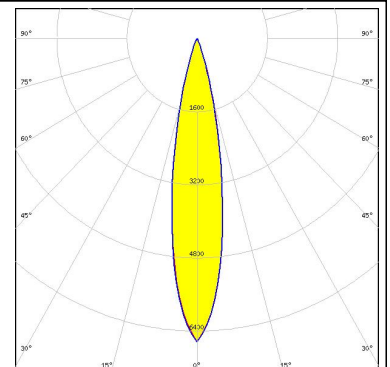

## PHOTOMETRIC DATA (SIMULATED):

**OSRAM**  
Opto Semiconductors

LED OSLON Black Flat  
FWHM 22.0°  
Efficiency 94 %  
Peak intensity 6.900 cd/lm  
LEDs/each optic 1  
Light colour White  
Required components:

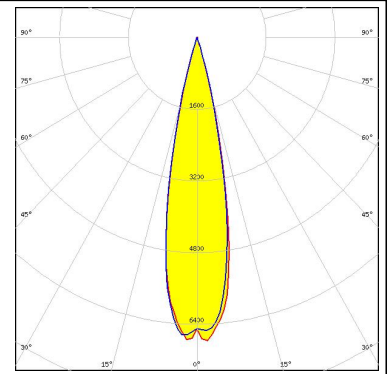

### GENERAL INFORMATION:

NOTE: The typical beam angle will be changed by different color, chip size and chip position tolerance. The typical total beam angle is the full angle measured where the luminous intensity is half of the peak value.

### MATERIALS:

As part of our continuous research and improvement processes, and to ensure the best possible quality and availability of our products, LEDiL reserves the right to change material grades without notice.

### PRODUCT DATA USER AGREEMENT AND DISCLAIMER:

The measured data in the provided downloadable LEDiL Product Datasheets and Mechanical 2D-Drawings is rounded and provided as reference for planning. LEDiL Oy's optical specifications have been verified by conducting performance testing of the products in accordance with the company's quality system. The reported data are averaged results of multiple measurements with typical variation. LEDiL Oy reserves the right to without prior notification make changes and improvements to its products.

LEDiL Oy assumes neither warranty, nor guarantee nor any other liability of any kind for the contents and correctness of the provided data. The provided data has been generated with highest diligence but the provided data may in reality not represent the complete possible variation range of all intrinsic parameters. Therefore, in certain cases a deviation from the provided data could occur.

LEDiL Oy reserves the right to undertake technical changes of its products without further notification which could lead to changes in the provided data. LEDiL Oy assumes no liability of any kind for the possible deviation from any provided data or any other damage resulting from the usage of the provided data.

The user agrees to this disclaimer and user agreement with the download or usage of the provided files.

#### LEDiL Oy

Joensuunkatu 13  
FI-24240 SALO  
Finland

#### LEDiL Inc.

228 West Page Street  
Suite D  
Sycamore IL 60178  
USA

#### Local sales and technical support

[www.ledil.com/  
where\\_to\\_buy](http://www.ledil.com/where_to_buy)

#### Shipping locations

Salo, Finland  
Hong Kong, China

#### Distribution Partners

[www.ledil.com/  
where\\_to\\_buy](http://www.ledil.com/where_to_buy)