

Subject to changes. Please also observe the further product documentation!

WAGO GmbH & Co. KG
 Hansastr. 27
 32423 Minden
 Phone: +49571 887-0 | Fax: +49571 887-169
 Email: info.de@wago.com | Web: www.wago.com

Do you have any questions about our products?
 We are always happy to take your call at +49 (571) 887-44222.

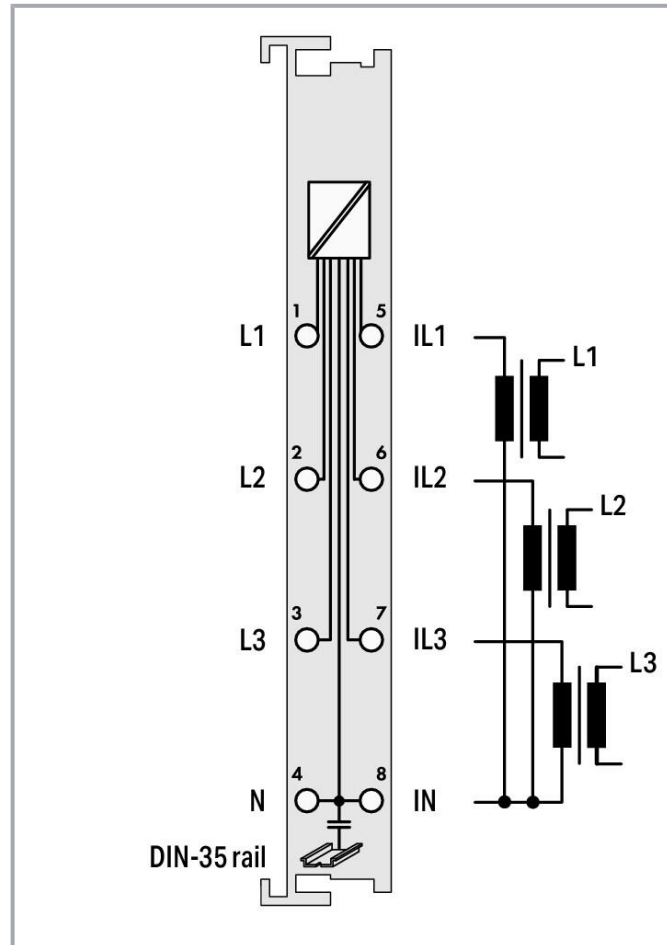
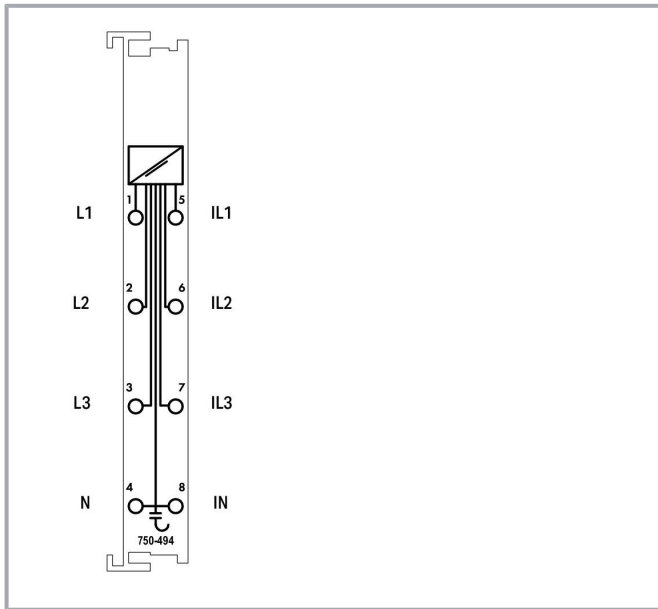

Item description

The 750-494 3-Phase Power Measurement Module measures electrical data in a three-phase supply network.

The voltage is measured via network connection to clamping points L1, L2, L3 and N.

The current of the three phases is fed to IL1, IL2, IL3, and IN via current transformers.

The 3-phase power measurement module transmits all metrics (e.g., reactive/apparent/effective power, energy consumption, power factor, phase angle, frequency, over-/undervoltage) directly to the process image, without requiring high computing power from the controller. Both comprehensive metrics and harmonic analysis up to the 41st harmonic permit extensive network analysis via the fieldbus. These metrics enable the operator to optimize supply to a drive or machine, protecting the system from damage and failure. The four-quadrant display indicates the load type (inductive, capacitive) and whether it is an energy consumer or producer.

Subject to changes. Please also observe the further product documentation!



Data

Technical data

Number of measurement inputs	6 (3 voltage measurement inputs, 3 current measurement inputs)
Signal type	Power measurement
Signal form	Any periodic signals (considering the threshold frequencies)
Resolution [bit]	24 bits
Data width	2 x 128-bit data; 2 x 64-bit control/status
Voltage path input resistance (typ.)	1072 kΩ
Current path input resistance (typ.)	22 mΩ
Reference for measurement error	AC current/voltage
Measurement error (reference temperature)	25 °C
Measurement error, deviation (max.) from the upper-range value	0.5 %
Measurement current (max.)	1 A
Measurement cycle time	Adjustable for the arithmetic mean value, min./max. values
Frequency range (mains frequency)	45 ... 65 Hz
Frequency range (harmonics analysis)	0 ... 3300 Hz
Limit frequency	15.9 kHz
Rated voltage	$U_{LN} = 277 \text{ VAC/DC}$; $U_{LL} = 480 \text{ VAC}$
Calculated values	Line-to-line voltage, power output, energy, power factors, mains frequency, harmonic analysis (up to the 41st harmonic), THD
Measurement components	Evaluating
Measurement method	True RMS measurement
Configuration options	WAGO-I/O-CHECK CODESYS Library <i>e!COCKPIT</i>
Supply voltage (system)	5 VDC; via data contacts
Current consumption (5 V system supply)	100 mA
Isolation	4 kV system/field
Rated surge voltage	4 kV
Indicators	LED (A) green: Communication; LED (B-G) red: Error L1, Display: Override in current measurement path, Display: Undervoltage in voltage measurement path, Error L2, Error L3, Display: Override in voltage measurement path; LED (H) yellow: Interchange in phase sequence L1-L2-L3

Connection data

Connection technology: inputs/outputs	8 x CAGE CLAMP®
---------------------------------------	-----------------

Subject to changes. Please also observe the further product documentation!



Connection type 1	Inputs/Outputs
Solid conductor	0.08 ... 2.5 mm ² / 28 ... 14 AWG
Fine-stranded conductor	0.08 ... 2.5 mm ² / 28 ... 14 AWG
Strip length	8 ... 9 mm / 0.31 ... 0.35 inches

Physical data

Width	12 mm / 0.472 inches
Height	100 mm / 3.937 inches
Depth	67.8 mm / 2.669 inches
Depth from upper-edge of DIN-rail	60.6 mm / 2.386 inches

Mechanical Data

Mounting type	DIN-35 rail
---------------	-------------

Material Data

Color	light gray
Housing material	Polycarbonate; polyamide 6.6
Fire load	0.955 MJ
Weight	49.6 g
Conformity marking	CE

Environmental requirements

Ambient temperature (operation)	0 ... +55 °C
Ambient temperature (storage)	-25 ... +85 °C
Protection type	IP20
Pollution degree	2
Operating altitude	0 ... 2000 m / 0 ... 6562 ft
Mounting position	horizontal (standing/lying); vertical
Relative humidity (without condensation)	95 %
Vibration resistance	4g per IEC 60068-2-6
Shock resistance	15g per IEC 60068-2-27
EMC immunity to interference	per EN 61000-6-2
EMC emission of interference	per EN 61000-6-3
Exposure to pollutants	Per IEC 60068-2-42 and IEC 60068-2-43
Permissible H ₂ S contaminant concentration at a relative humidity 75 %	10 ppm

Subject to changes. Please also observe the further product documentation!

WAGO GmbH & Co. KG
 Hansastr. 27
 32423 Minden
 Phone: +49571 887-0 | Fax: +49571 887-169
 Email: info.de@wago.com | Web: www.wago.com

Do you have any questions about our products?
 We are always happy to take your call at +49 (571) 887-44222.

Permissible SO₂ contaminant concentration at a relative humidity 75 % 25 ppm

Commercial data

Product Group	15 (I/O System)
eCl@ss 10.0	27-24-26-05
eCl@ss 9.0	27-24-26-05
ETIM 8.0	EC001601
ETIM 7.0	EC001601
PU (SPU)	1 pcs
Packaging type	box
Country of origin	DE
GTIN	4050821548232
Customs tariff number	85389099990

Environmental Product Compliance

CAS-No.	1314-23-4 1317-36-8 7439-92-1
REACH Candidate List Substance	Lead Lead monoxide Zirconium Oxide
RoHS Compliance Status	Compliant,With Exemption
RoHS Exemption	6(c) 7(a) 7(c)-I 7(c)-II
SCIP notification number (Bulgaria)	1bec5928-bed4-4802-bc3f-c6a7da938b3c
SCIP notification number (Czech Republic)	be0c6abd-7f4b-4dbf-b3f4-f58e3fc68eee

Approvals / Certificates

General approvals

Logo	Approval	Additional Approval Text	Certificate name
	CCC CNEX	CNCA-C23-01	2020312310000213 (Ex ec IIC T4 Gc)
	EAC Brjansker Zertifizierungsstelle	TP TC 020/2011	EAC RU C-DE.AM02. B.00087/19

Subject to changes. Please also observe the further product documentation!

WAGO GmbH & Co. KG
Hansastr. 27
32423 Minden
Phone: +49571 887-0 | Fax: +49571 887-169
Email: info.de@wago.com | Web: www.wago.com

Do you have any questions about our products?
We are always happy to take your call at +49 (571) 887-44222.



UL
Underwriters Laboratories Inc. (ORDINARY
LOCATIONS)





UL 508

E175199 Sec.1

Declarations of conformity and manufacturer's declarations

Logo	Approval	Additional Approval Text	Certificate name
	EU-Declaration of Conformity WAGO GmbH & Co. KG	-	-

Approvals for marine applications

Logo	Approval	Additional Approval Text	Certificate name
	BSH Bundesamt fuer Seeschifffahrt und Hydrographie	-	1104
	DNV DNV GL SE	DNV-CG-0339, Aug. 2021	TAA0000194
	PRS Polski Rejestr Statków	-	TE/2236/880590 /19
	RINA RINA Germany GmbH	-	ELE343521XG001

Approvals for hazardous areas

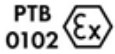
Logo	Approval	Additional Approval Text	Certificate name
	ATEX TUEV Nord Cert GmbH	EN 60079-0	TUEV_14_ATEX_148929_X (II 3 G Ex ec IIC T4 Gc)
	CCC CNEX	CNCA-C23-01	2020312310000213 (Ex ec IIC T4 Gc)

Subject to changes. Please also observe the further product documentation!

WAGO GmbH & Co. KG
Hansastr. 27
32423 Minden
Phone: +49571 887-0 | Fax: +49571 887-169
Email: info.de@wago.com | Web: www.wago.com

Do you have any questions about our products?
We are always happy to take your call at +49 (571) 887-44222.



EAC
Brjansker Zertifizierungsstelle

TP TC 012/2011

EAC RU C-DE.AM02.B.00163
/19 (2Ex nA IIC T4 Gc X)



IECEX
TUEV Nord Cert GmbH

IEC 60079-0

IECEX TUN 14.0035 X (Ex ec
IIC T4 Gc)



INMETRO
TÜV Rheinland do Brasil Ltda.

IEC 60079-0

BR-Ex_TÜV 12.1297 X



UKEx
WAGO GmbH & Co. KG

EN 60079-0

UKCA_WAGO22UKEX003X_ec

Optional accessories

Marking accessories

Marker carrier



Item no.: 750-103
Group marker carrier

www.wago.com/750-103

Marker

Item no.: 2009-145/000-006

Mini-WSB Inline; for Smart Printer; 1700 pieces on roll; stretchable 5 - 5.2 mm; plain; snap-on type; blue /000-006

www.wago.com/2009-145

Item no.: 2009-145

Mini-WSB Inline; for Smart Printer; 1700 pieces on roll; stretchable 5 - 5.2 mm; plain; snap-on type; white

www.wago.com/2009-145

Item no.: 2009-145/000-002

Mini-WSB Inline; for Smart Printer; 1700 pieces on roll; stretchable 5 - 5.2 mm; plain; snap-on type; yellow

www.wago.com/2009-145
/000-002

Item no.: 2009-145/000-007

Mini-WSB Inline; for Smart Printer; 1700 pieces on roll; stretchable 5 - 5.2 mm; plain; snap-on type; gray /000-007

www.wago.com/2009-145

Subject to changes. Please also observe the further product documentation!

WAGO GmbH & Co. KG

Hansastr. 27











32423 Minden

Phone: +49571 887-0 | Fax: +49571 887-169

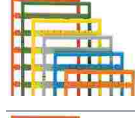
Email: info.de@wago.com | Web: www.wago.com

Do you have any questions about our products?

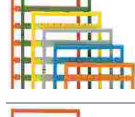
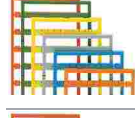
We are always happy to take your call at +49 (571) 887-44222.

	<p>Item no.: 2009-145/000-005 Mini-WSB Inline; for Smart Printer; 1700 pieces on roll; stretchable 5 - 5.2 mm; plain; snap-on type; red</p>	www.wago.com/2009-145/000-005
	<p>Item no.: 2009-145/000-012 Mini-WSB Inline; for Smart Printer; 1700 pieces on roll; stretchable 5 - 5.2 mm; plain; snap-on type; orange</p>	www.wago.com/2009-145/000-012
	<p>Item no.: 2009-145/000-023 Mini-WSB Inline; for Smart Printer; 1700 pieces on roll; stretchable 5 - 5.2 mm; plain; snap-on type; green</p>	www.wago.com/2009-145/000-023
	<p>Item no.: 2009-145/000-024 Mini-WSB Inline; for Smart Printer; 1700 pieces on roll; stretchable 5 - 5.2 mm; plain; snap-on type; violet</p>	www.wago.com/2009-145/000-024
	<p>Item no.: 248-501/000-006 Mini-WSB marking card; as card; not stretchable; plain; snap-on type; blue</p>	www.wago.com/248-501/000-006
	<p>Item no.: 248-501/000-007 Mini-WSB marking card; as card; not stretchable; plain; snap-on type; gray</p>	www.wago.com/248-501/000-007
	<p>Item no.: 248-501/000-002 Mini-WSB marking card; as card; not stretchable; plain; snap-on type; yellow</p>	www.wago.com/248-501/000-002
	<p>Item no.: 248-501/000-012 Mini-WSB marking card; as card; not stretchable; plain; snap-on type; orange</p>	www.wago.com/248-501/000-012
	<p>Item no.: 248-501 Mini-WSB marking card; as card; not stretchable; plain; snap-on type; white</p>	www.wago.com/248-501
	<p>Item no.: 248-501/000-017 Mini-WSB marking card; as card; not stretchable; plain; snap-on type; light green</p>	www.wago.com/248-501/000-017
	<p>Item no.: 248-501/000-005 Mini-WSB marking card; as card; not stretchable; plain; snap-on type; red</p>	www.wago.com/248-501/000-005
	<p>Item no.: 248-501/000-024 Mini-WSB marking card; as card; not stretchable; plain; snap-on type; violet</p>	www.wago.com/248-501/000-024

Subject to changes. Please also observe the further product documentation!

**Item no.:** 248-501/000-023

Mini-WSB marking card; as card; not stretchable; plain; snap-on type; green

www.wago.com/248-501/000-023

Group marker carrier

**Item no.:** 750-107

Group marker carrier

www.wago.com/750-107

Carrier rail

Mounting accessories

**Item no.:** 210-197

Steel carrier rail; 35 x 15 mm; 1.5 mm thick; 2 m long; slotted; similar to EN 60715; silver-colored

www.wago.com/210-197**Item no.:** 210-198

Copper carrier rail; 35 x 15 mm; 2.3 mm thick; 2 m long; unslotted; according to EN 60715; copper-colored

www.wago.com/210-198**Item no.:** 210-504

Steel carrier rail; 35 x 7.5 mm; 1 mm thick; 2 m long; slotted; galvanized; according to EN 60715; silver-colored

www.wago.com/210-504**Item no.:** 210-505

Steel carrier rail; 35 x 7.5 mm; 1 mm thick; 2 m long; unslotted; galvanized; according to EN 60715; silver-colored

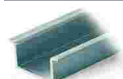
www.wago.com/210-505**Item no.:** 210-506

Steel carrier rail; 35 x 15 mm; 1.5 mm thick; 2 m long; unslotted; galvanized; similar to EN 60715; silver-colored

www.wago.com/210-506**Item no.:** 210-508

Steel carrier rail; 35 x 15 mm; 1.5 mm thick; 2 m long; slotted; galvanized; similar to EN 60715; silver-colored

www.wago.com/210-508**Item no.:** 210-113

Steel carrier rail; 35 x 7.5 mm; 1 mm thick; 2 m long; unslotted; according to EN 60715; silver-colored

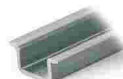
www.wago.com/210-113**Item no.:** 210-118

Steel carrier rail; 35 x 15 mm; 2.3 mm thick; 2 m long; unslotted; according to EN 60715; silver-colored

www.wago.com/210-118**Item no.:** 210-112

Steel carrier rail; 35 x 7.5 mm; 1 mm thick; 2 m long; slotted; according to EN 60715; "Hole width 25 mm; silver-colored

www.wago.com/210-112**Item no.:** 210-114

Steel carrier rail; 35 x 15 mm; 1.5 mm thick; 2 m long; unslotted; similar to EN 60715; silver-colored

www.wago.com/210-114**Item no.:** 210-115

Steel carrier rail; 35 x 7.5 mm; 1 mm thick; 2 m long; slotted; according to EN 60715; "Hole width 18 mm; silver-colored

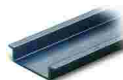
www.wago.com/210-115**Item no.:** 210-196

Aluminum carrier rail; 35 x 8.2 mm; 1.6 mm thick; 2 m long; unslotted; similar to EN 60715; silver-colored

www.wago.com/210-196

Subject to changes. Please also observe the further product documentation!

WAGO GmbH & Co. KG

Hansastr. 27

32423 Minden

Phone: +49571 887-0 | Fax: +49571 887-169

Email: info.de@wago.com | Web: www.wago.com

Do you have any questions about our products?

We are always happy to take your call at +49 (571) 887-44222.

Potential distribution

Current and voltage tap



Item no.: 855-951/250-000

Current and voltage tap up to 95 mm²; Primary rated current: 250 A; Secondary rated current: 1 A; Rated power: 0.2 VA; Accuracy class: 0.5; fused

www.wago.com/855-951/250-000

Voltage tap

Power tap



Item no.: 855-8001

Power tap; with fuse; 2,5 mm² (12 AWG) - 6 mm² (10 AWG); Phase

www.wago.com/855-8001



Item no.: 855-8002

Power tap; without fuse; 2,5 mm² (12 AWG) - 6 mm² (10 AWG); N-conductor

www.wago.com/855-8002



Item no.: 855-8004

Power tap; without fuse; 10 mm² (8 AWG) - 16 mm² (6 AWG); N-conductor

www.wago.com/855-8004



Item no.: 855-8003

Power tap; with fuse; 10 mm² (8 AWG) - 16 mm² (6 AWG); Phase

www.wago.com/855-8003

System housing

System enclosure



Item no.: 850-814/002-000

IP65 enclosure; Sheet steel (RAL 7035); WxHxD (200x120x200 mm); without flange plate

www.wago.com/850-814/002-000



Item no.: 850-815/002-000

IP65 enclosure; Sheet steel (RAL 7035); WxHxD (300x120x200 mm); without flange plate

www.wago.com/850-815/002-000



Item no.: 850-816/002-000

IP65 enclosure; Sheet steel (RAL 7035); WxHxD (400x120x200 mm); without flange plate

www.wago.com/850-816/002-000



Item no.: 850-817/002-000

IP65 enclosure; Sheet steel (RAL 7035); WxHxD (600x120x200 mm); without flange plate

www.wago.com/850-817/002-000



Item no.: 850-825

IP65 enclosure; Aluminium (RAL 7032); WxHxD (160x100x160 mm); 9 x M12, 4 x M20

www.wago.com/850-825



Item no.: 850-826

IP65 enclosure; Aluminium (RAL 7032); WxHxD (240x100x160 mm); 4 x M20, 4 x M16, 14 x M12 cable grip

www.wago.com/850-826



Item no.: 850-827

IP65 enclosure; Aluminium (RAL 7032); WxHxD (320x100x160 mm); 4 x M20, 8 x M16, 17 x M12 cable grip

www.wago.com/850-827

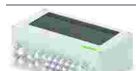

Item no.: 850-827/002-000

IP65 enclosure; Aluminium (RAL 7035); WxHxD (320x100x160 mm); 4 x M20, 8 x M16, 17 x M12 cable grip

www.wago.com/850-827/002-000

Subject to changes. Please also observe the further product documentation!

WAGO GmbH & Co. KG

Hansastr. 27







32423 Minden

Phone: +49571 887-0 | Fax: +49571 887-169

Email: info.de@wago.com | Web: www.wago.com







Do you have any questions about our products?

We are always happy to take your call at +49 (571) 887-44222.

	Item no.: 850-826/002-000 IP65 enclosure; Aluminium (RAL 7035); WxHxD (240x100x160 mm); 4 x M20, 4 x M16, 14 x M12 cable grip	www.wago.com/850-826/002-000
	Item no.: 850-828/002-000 IP65 enclosure; Aluminium (RAL 7035); WxHxD (480x100x160 mm); 4 x M20, 10 x M16, 35 x M12 cable grip	www.wago.com/850-828/002-000
	Item no.: 850-828 IP65 enclosure; Aluminium (RAL 7032); WxHxD (480x100x160 mm); 4 x M20, 10 x M16, 35 x M12 cable grip	www.wago.com/850-828
	Item no.: 850-834 IP65 enclosure; Polyester (RAL 7032); WxHxD (164x100x164 mm); 9 x M12, 4 x M20	www.wago.com/850-834
	Item no.: 850-835 IP65 enclosure; Polyester (RAL 7032); WxHxD (244x100x164 mm); 4 x M20, 4 x M16, 14 x M12 cable grip	www.wago.com/850-835
	Item no.: 850-836 IP65 enclosure; Polyester (RAL 7032); WxHxD (324x100x164 mm); 4 x M20, 8 x M16, 17 x M12 cable grip	www.wago.com/850-836

Current transformers

Split-core current transformer



	Item no.: 855-4101/200-001 Split-core current transformer; Primary rated current: 200 A; Secondary rated current: 1 A; Rated power: 0.2 VA; Accuracy class: 1; Cable length: 3 m	www.wago.com/855-4101/200-001
	Item no.: 855-4101/250-001 Split-core current transformer; Primary rated current: 250 A; Secondary rated current: 1 A; Rated power: 0.2 VA; Accuracy class: 1; Cable length: 3 m	www.wago.com/855-4101/250-001
	Item no.: 855-4101/400-001 Split-core current transformer; Primary rated current: 400 A; Secondary rated current: 1 A; Rated power: 0.2 VA; Accuracy class: 1; Cable length: 3 m	www.wago.com/855-4101/400-001
	Item no.: 855-5001/1000-000 Split-core current transformer; Primary rated current: 1000 A; Secondary rated current: 1 A; Rated power: 0.5 VA; Accuracy class: 0.5; Cable length: 5 m	www.wago.com/855-5001/1000-000
	Item no.: 855-5001/250-001 Split-core current transformer; Primary rated current: 250 A; Secondary rated current: 1 A; Rated power: 0.5 VA; Accuracy class: 1; Cable length: 5 m	www.wago.com/855-5001/250-001
	Item no.: 855-5001/400-000 Split-core current transformer; Primary rated current: 400 A; Secondary rated current: 1 A; Rated power: 0.5 VA; Accuracy class: 0.5; Cable length: 5 m	www.wago.com/855-5001/400-000

Item no.: 855-3001/200-001

Subject to changes. Please also observe the further product documentation!

	Split-core current transformer; Primary rated current: 200 A; Secondary rated current: 1 A; Rated power: 0.2 VA; Accuracy class: 1; Cable length: 3 m	www.wago.com/855-3001/200-001
	Item no.: 855-3001/250-001 Split-core current transformer; Primary rated current: 250 A; Secondary rated current: 1 A; Rated power: 0.2 VA; Accuracy class: 1; Cable length: 3 m	www.wago.com/855-3001/250-001
	Item no.: 855-3001/060-003 Split-core current transformer; Primary rated current: 60 A; Secondary rated current: 1 A; Rated power: 0.2 VA; Accuracy class: 3; Cable length: 3 m	www.wago.com/855-3001/060-003
	Item no.: 855-5001/600-000 Split-core current transformer; Primary rated current: 600 A; Secondary rated current: 1 A; Rated power: 0.5 VA; Accuracy class: 0.5; Cable length: 5 m	www.wago.com/855-5001/600-000
	Item no.: 855-5101/1000-000 Split-core current transformer; Primary rated current: 1000 A; Secondary rated current: 1 A; Rated power: 0.5 VA; Accuracy class: 0.5; Cable length: 5 m	www.wago.com/855-5101/1000-000
	Item no.: 855-4001/100-001 Split-core current transformer; Primary rated current: 100 A; Secondary rated current: 1 A; Rated power: 0.2 VA; Accuracy class: 1; Cable length: 3 m	www.wago.com/855-4001/100-001
	Item no.: 855-4001/150-001 Split-core current transformer; Primary rated current: 150 A; Secondary rated current: 1 A; Rated power: 0.2 VA; Accuracy class: 1; Cable length: 3 m	www.wago.com/855-4001/150-001
	Item no.: 855-4001/200-001 Split-core current transformer; Primary rated current: 200 A; Secondary rated current: 1 A; Rated power: 0.2 VA; Accuracy class: 0.5; Cable length: 3 m	www.wago.com/855-4001/200-001
	Item no.: 855-3001/100-003 Split-core current transformer; Primary rated current: 100 A; Secondary rated current: 1 A; Rated power: 0.2 VA; Accuracy class: 3; Cable length: 3 m	www.wago.com/855-3001/100-003











Current transformer terminal block

	Item no.: 2007-8875 Compact terminal block; for current transformer circuit; 6,00 mm ² ; multicoloured	www.wago.com/2007-8875
	Item no.: 2007-8873 Compact terminal block; for current and voltage transformers; 6,00 mm ² ; multicoloured	www.wago.com/2007-8873

Plug-in current transformer

Item no.: 855-301/075-201

Subject to changes. Please also observe the further product documentation!

	Plug-in current transformer; Primary rated current: 75 A; Secondary rated current: 1 A; Rated power: 2.5 VA; Accuracy class: 1	www.wago.com/855-301/075-201
	Item no.: 855-301/150-501 Plug-in current transformer; Primary rated current: 150 A; Secondary rated current: 1 A; Rated power: 5 VA; Accuracy class: 1	www.wago.com/855-301/150-501
	Item no.: 855-301/200-501 Plug-in current transformer; Primary rated current: 200 A; Secondary rated current: 1 A; Rated power: 5 VA; Accuracy class: 1	www.wago.com/855-301/200-501
	Item no.: 855-301/400-1001 Plug-in current transformer; Primary rated current: 400 A; Secondary rated current: 1 A; Rated power: 10 VA; Accuracy class: 1	www.wago.com/855-301/400-1001
	Item no.: 855-301/050-103 Plug-in current transformer; Primary rated current: 50 A; Secondary rated current: 1 A; Rated power: 1.25 VA; Accuracy class: 3	www.wago.com/855-301/050-103
	Item no.: 855-301/100-201 Plug-in current transformer; Primary rated current: 100 A; Secondary rated current: 1 A; Rated power: 2.5 VA; Accuracy class: 1	www.wago.com/855-301/100-201
	Item no.: 855-301/250-501 Plug-in current transformer; Primary rated current: 250 A; Secondary rated current: 1 A; Rated power: 5 VA; Accuracy class: 1	www.wago.com/855-301/250-501
	Item no.: 855-301/600-1001 Plug-in current transformer; Primary rated current: 600 A; Secondary rated current: 1 A; Rated power: 10 VA; Accuracy class: 1	www.wago.com/855-301/600-1001
	Item no.: 855-801/2000-1001 Plug-in current transformer; Primary rated current: 2000 A; Secondary rated current: 1 A; Rated power: 10 VA; Accuracy class: 1	www.wago.com/855-801/2000-1001
	Item no.: 855-2701/035-001 Plug-in current transformer; Primary rated current: 35 A; Secondary rated current: 1 A; Rated power: 0.2 VA; Accuracy class: 1	www.wago.com/855-2701/035-001
	Item no.: 855-1001/2500-1001 Plug-in current transformer; Primary rated current: 2500 A; Secondary rated current: 1 A; Rated power: 10 VA; Accuracy class: 1	www.wago.com/855-1001/2500-1001

Subject to changes. Please also observe the further product documentation!



Item no.: 855-1700/032-000
Plug-in current transformer; Primary rated current 32 A; Secondary rated current 320 mA

www.wago.com/855-1700/032-000



Item no.: 855-301/060-101
Plug-in current transformer; Primary rated current: 60 A; Secondary rated current: 1 A; Rated power: 1.25 VA; Accuracy class: 1

www.wago.com/855-301/060-101



Item no.: 855-2701/064-001
Plug-in current transformer; Primary rated current: 64 A; Secondary rated current: 1 A; Rated power: 0.2 VA; Accuracy class: 1

www.wago.com/855-2701/064-001



Item no.: 855-501/1000-1001
Plug-in current transformer; Primary rated current: 1000 A; Secondary rated current: 1 A; Rated power: 10 VA; Accuracy class: 1

www.wago.com/855-501/1000-1001



Item no.: 855-601/1500-501
Plug-in current transformer; Primary rated current: 1500 A; Secondary rated current: 1 A; Rated power: 5 VA; Accuracy class: 1

www.wago.com/855-601/1500-501



Item no.: 855-401/600-501
Plug-in current transformer; Primary rated current: 600 A; Secondary rated current: 1 A; Rated power: 10 VA; Accuracy class: 1

www.wago.com/855-401/600-501



Item no.: 855-401/400-501
Plug-in current transformer; Primary rated current: 400 A; Secondary rated current: 1 A; Rated power: 5 VA; Accuracy class: 1

www.wago.com/855-401/400-501



Item no.: 855-501/800-1001
Plug-in current transformer; Primary rated current: 800 A; Secondary rated current: 1 A; Rated power: 10 VA; Accuracy class: 1

www.wago.com/855-501/800-1001



Item no.: 855-501/400-1001
Plug-in current transformer; Primary rated current: 400 A; Secondary rated current: 1 A; Rated power: 10 VA; Accuracy class: 1

www.wago.com/855-501/400-1001



Item no.: 855-501/600-1001
Plug-in current transformer; Primary rated current: 600 A; Secondary rated current: 1 A; Rated power: 10 VA; Accuracy class: 1

www.wago.com/855-501/600-1001



Item no.: 855-401/250-501
Plug-in current transformer; Primary rated current: 250 A; Secondary rated current: 1 A; Rated power: 5 VA; Accuracy class: 1

www.wago.com/855-401/250-501









Item no.: 855-801/1000-1001
Plug-in current transformer; Primary rated current: 1000 A; Secondary rated current: 1 A; Rated power: 10 VA; Accuracy class: 1

www.wago.com/855-801/1000-1001

Subject to changes. Please also observe the further product documentation!

Shield termination

Shield clamping saddles		
	Item no.: 790-116 Shield clamping saddle; 19 mm wide; diameter of compatible conductor; 7 ... 16 mm	www.wago.com/790-116
	Item no.: 790-124 Shield clamping saddle; 27 mm wide; diameter of compatible conductor; 6 ... 24 mm	www.wago.com/790-124
	Item no.: 790-108 Shield clamping saddle; 11 mm wide; diameter of compatible conductor; 3 ... 8 mm	www.wago.com/790-108
	Item no.: 790-140 Shield clamping saddle; diameter of compatible conductor	www.wago.com/790-140
	Item no.: 790-216 Shield clamping saddle; 21.8 mm wide; 6 ... 16 mm	www.wago.com/790-216
	Item no.: 790-220 Shield clamping saddle; 30 mm wide; 6 ... 20 mm	www.wago.com/790-220
	Item no.: 790-208 Shield clamping saddle; 12.4 mm wide; 3 ... 8 mm	www.wago.com/790-208

Downloads

Documentation

Manual

System Manual WAGO I/O System 750/753 Decentralized Automation Technology	V 3.3.0 2023 May 4	pdf 8.8 MB	Download
Product Manual 3-Phase Power Measurement Module 480 V	V 1.2.0	pdf 4.8 MB	Download
System Manual Series 750/753 Online HTML		URL	Download

Bid Text

750-494 X81 - Datei	2019 Feb 19	xml 6.2 kB	Download
750-494 doc - Datei	2017 Oct 20	doc 31.2 kB	Download
ausschreiben.de 750-494		URL	Download

Subject to changes. Please also observe the further product documentation!



Instruction Leaflet

CCC Ex (Additional information) WAGO-I/O-SYSTEM *750-****/*	2023 Apr 26	pdf 163.6 kB	Download
--	-------------	-----------------	----------

Additional Information

Disposal and Recycling Electrical and electronic equipment, Batteries, Packaging	V 1.1.0 2022 Aug 18	pdf 2.2 MB	Download
---	------------------------	---------------	----------

System Description

Overview on WAGO-I/O-SYSTEM 750 approvals		pdf 789.0 kB	Download
750/753 Series I/O-System – General Product Information		pdf 1.7 MB	Download

Application Notes

Application note SIEMENS

WagoS7_PowerMeasurement_494 (a500610) This application note shows how to access the Wago 3-Phase Power measurement module in Step 7 V5.5.	2.1.1 2017 Nov 22	zip 3.1 MB	Download
WagoTIA_PowerMeasurement_494 (a500611) This application note shows how to access the Wago 3-Phase Power measurement module in TIA. The example project contains two PLC devices, one for a S7-300 and one for a S7-1500. The S7-1500 PLC supports optimized block access.	1.0.1 2017 Nov 22	zip 6.6 MB	Download

Application Note CoDeSys 2.3

Application Note for the 750-494 3-Phase Power Measurement Module The application note for the 3-Phase Power Measurement Module 750-494 shows how the measured values of the power measurement module can be read. It is also shown how the power module can be configured using the WAGO-I/O-PRO- V2.3 visualization tool.	24.01.2014 2014 Nov 11	zip 1.7 MB	Download
--	---------------------------	---------------	----------

Application Note e!COCKPIT

e!COCKPIT Application Note WagoAppPowerMeasurement This Application Note describes the use of the library WagoAppPowerMeasurement under different boundary conditions.	2021-11-08 2021 Dec 6	pdf 953.0 kB	Download
---	--------------------------	-----------------	----------

Subject to changes. Please also observe the further product documentation!



Libraries

e!COCKPIT libraries

e!COCKPIT Library Description WagoAppPowerMeasurement	1.7.4.0 2021 May 25	pdf 1.4 MB	Download
---	------------------------	---------------	----------

Library

Bausteinbeschreibung für die PowerMeasurement_494_02.lib	4.1.2 2020 Jun 23	zip 1.9 MB	Download
Bausteinbeschreibungen für die 3-Phasen-Leistungsmessklemme 750-494			

CAD/CAE-Data

CAD data

2D/3D Models 750-494		URL	Download
----------------------	--	-----	----------

CAE data

EPLAN Data Portal 750-494		URL	Download
---------------------------	--	-----	----------

WSCAD Universe 750-494		URL	Download
------------------------	--	-----	----------

ZUKEN Portal 750-494		URL	Download
----------------------	--	-----	----------

Environmental Product Compliance

Compliance Search

Environmental Product Compliance 750-494 3-Phase Power Measurement; 480 VAC, 1 A		URL	Download
---	--	-----	----------

Installation Notes

Product family

WAGO I/O System 750/753
[Show all products from the family](#)

Subject to changes. Please also observe the further product documentation!