

Phone: (815) 433-5100  
 Fax: (815) 4334-5104  
 www.bb-elec.com

## PROFIBUS OPTION CARD FOR VLINX FIELDBUS GATEWAY



- ADDS PROFIBUS DP CONNECTIVITY TO THE FIELDBUS GATEWAY
- PROFIBUS DP SLAVE PROTOCOL
- EASY INSTALLATION

### GENERAL DESCRIPTION

The Vlinx Fieldbus Gateway contains a proprietary expansion port which provides a high speed, parallel architecture that extends the functionality and flexibility of the platform. This approach allows these products to evolve concurrently with the latest advances in communications and standards, without sacrificing performance. This high bandwidth channel has significantly greater throughput when compared to the traditional (external) serial gateway approach.

The VFG9000-PBDP option card adds PROFIBUS DP connectivity to the series. This allows a high-speed exchange of blocks of data, at data rates up to 12MBaud, between the hosting Fieldbus Gateway and a Master PLC or PC on a PROFIBUS network. The DP suffix refers to “Decentralized Periphery”, which is used to describe distributed I/O devices connected via a fast serial data link with a central controller.

The VFG9000-PBDP communication card is easily installed by removing the blank expansion port cover of your Fieldbus Gateway, and plugging the VFG9000-PBDP card into the expansion port. Configuration is simple using B&B Electronics’ free Fieldbus Gateway Manager software.

### SAFETY SUMMARY

All safety related regulations, local codes and instructions that appear in the literature or on equipment must be observed to ensure personal safety and to prevent damage to either the instrument or equipment connected to it. If equipment is used in a manner not specified by the manufacturer, the protection provided by the equipment may be impaired.

Do not use the controller to directly command motors, valves, or other actuators not equipped with safeguards. To do so can be potentially harmful to persons or equipment in the event of a fault to the controller.



**CAUTION: Risk of Danger.**  
 Read complete instructions prior to installation and operation of the unit.

 WARNING - EXPLOSION HAZARD - SUBSTITUTION OF COMPONENTS MAY IMPAIR SUITABILITY FOR CLASS I, DIVISION 2

 THIS EQUIPMENT IS SUITABLE FOR USE IN CLASS I, DIVISION 2, GROUPS A, B, C, D, OR NON-HAZARDOUS LOCATIONS ONLY

### CONTENTS OF PACKAGE

- VFG9000-PBDP option card
- This hardware bulletin

### GSD FILE

The GSD file and associated bitmap are part of the Fieldbus Gateway Manager installation. After installing Fieldbus Gateway Manager, both files can be found on your PC’s hard drive at C:\Program Files\B&B Electronics\Vlinx Fieldbus Gateway Manager\Firmware.

### SPECIFICATIONS

- POWER REQUIREMENTS:** 24 V @ 70 mA max. Power is supplied to the option card from the main board of the Fieldbus Gateway.
- COMMUNICATIONS:**  
**PROFIBUS Port:** FIELDBUS Type: PROFIBUS-DP EN 50 170, I. The PROFIBUS port has autobaud detect up to 12M baud and is digitally isolated.
- CERTIFICATIONS AND COMPLIANCES:**  
 Refer to main unit manual or “Agency Approvals” section of B&B Electronics’ website for agency certifications.  
**ELECTROMAGNETIC COMPATIBILITY**  
 Emissions and Immunity to EN 61326: Electrical Equipment for Measurement, Control and Laboratory use.  
 Reference Fieldbus Gateway unit for EMC specifications
- ENVIRONMENTAL CONDITIONS:**  
 Refer to the specifications of the Fieldbus Gateway you are installing this card in.
- CONSTRUCTION:** For indoor use only. Installation Category II, Pollution Degree 2.
- INSTALLATION REQUIREMENTS:** See “Installing the VFG9000-PBDP Option card” for more details.
- WEIGHT:** 2.3 oz (65.2 g)

### ORDERING INFORMATION

DESCRIPTION	PART NUMBER
PROFIBUS option card for Fieldbus Gateway	VFG9000-PBDP

## INSTALLING THE VFG9000-PBDP OPTION CARD



**Caution:** The expansion and main circuit boards contain static sensitive components. Before handling the cards, discharge static charges from your body by touching a grounded bare metal object. Ideally, handle the cards at a static controlled clean workstation. Also, handle the cards by the edges only. Dirt, oil, or other contaminants that may contact the cards can adversely affect circuit operation.



**Warning: Risk of Danger:** Be sure to remove all power before removing the expansion port cover

**WARNING - EXPLOSION HAZARD - DO NOT DISCONNECT EQUIPMENT UNLESS POWER HAS BEEN SWITCHED OFF OR AREA IS KNOWN TO BE NON-HAZARDOUS.**

1. Remove power from the unit
2. Insert a flat-bladed screwdriver into the slot at the top of the expansion port cover. Gently apply pressure on the screwdriver in an upward direction until the expansion port cover disengages from the unit as shown in Figure 1.
3. Verify that the option card knobs are in the “unlocked” position as shown in Figure 2.
4. Carefully insert the option card into the expansion port opening while aligning the card-edge connector on the option card with the main board’s header, as shown in Figure 3. Once aligned, gently press on the front of the card until it is flush with the front of the case.
5. Turn the option card knobs to the locked position as shown in Figure 4.

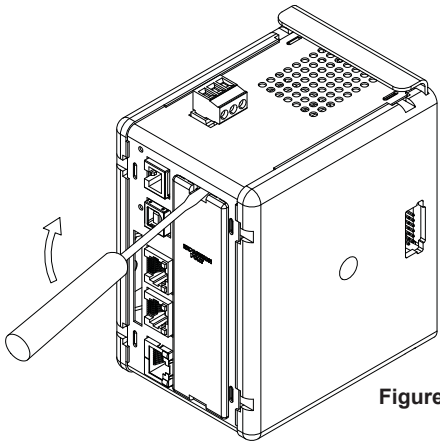

Figure 1

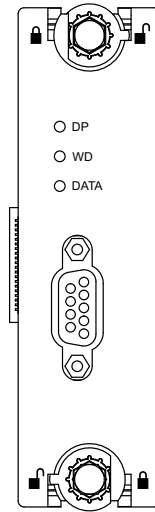

Figure 2

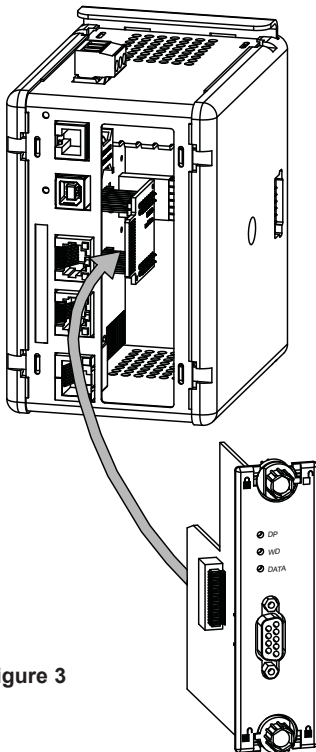

Figure 3

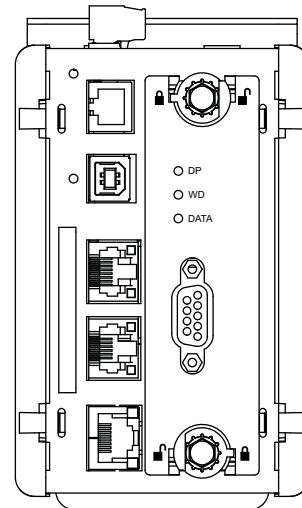
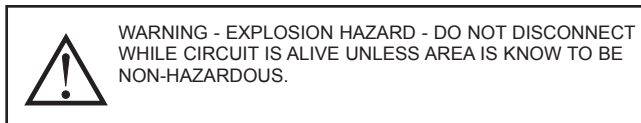

Figure 4

## POWER SUPPLY REQUIREMENTS NEW AND EXISTING INSTALLATIONS

The VFG9000-PBDP option card draws all of its power from the main board of the Fieldbus Gateway. The specifications of the Fieldbus Gateway account for the power needs of an option card.



## COMMUNICATING WITH THE VFG9000-PBDP OPTION CARD

### CONFIGURING THE VFG9000-PBDP OPTION CARD

The VFG9000-PBDP is configured using Fieldbus Gateway Manager software. Updates to the software for new features and drivers are posted on the website as they become available. By configuring the VFG9000-PBDP using the latest version of the software, you are assured that your unit has the most up-to-date feature set. Additional information can be found in your hardware bulletin and also in the Fieldbus Gateway Manager user manual.

To enable the option card, click on the left hand pane of the Communications window in Fieldbus Gateway Manager and highlight the icon that represents the Fieldbus Gateway. In the right pane, click the Option Card Selection's Edit button to show the selection dialog, and choose the PROFIBUS option card from the list. The PROFIBUS option card will then appear in the left hand pane, installed in the tree of available ports.

### CONFIGURING THE DRIVER

To select a driver, click on the left hand pane of the Communications window and highlight the PROFIBUS Interface icon. In the right hand pane, click the Driver Selection Edit button to show the Driver Selection dialog and select the PROFIBUS DP driver from the list.

The Station Address of the PROFIBUS node is the only property that needs to be configured. This should be a unique address on the PROFIBUS Network in the range 1..125.

### CONFIGURING THE DATA TAGS

A PROFIBUS master exchanges data with slaves as separate input and output blocks. Data transfer direction is described with respect to the PROFIBUS Network such that input data is transferred to the network, or written by the Fieldbus Gateway and output data is transferred from the network or read by the Fieldbus Gateway. This is important when it comes to configuring the data access for each tag mapped to a PROFIBUS data block.

### MAPPING TAGS TO PROFIBUS

PROFIBUS data blocks have no concept or knowledge of data type or structure – they are described by a size in bytes. Fieldbus Gateway Manager's tag-based approach to data allows for data of mixed type, bytes, 16-bit words, 32-bit words and 32-bit floating point numbers to be mapped into a single data block. To map a data tag to a PROFIBUS data block, click in the left hand pane of the Data Tags window, highlight the required Data Tag icon. In the right hand pane click the Data Mapping button and select the PROFIBUS device to show the Select Address for PROFIBUS DP dialog.

The Block Type defines whether the tag will be read from (Output Block) or written to (Input Block) the PROFIBUS network

The Data Offset is the byte address of the Data Tag within the Data Block

The Data Type is the actual size in bytes of the data that will be mapped into the Data Block.

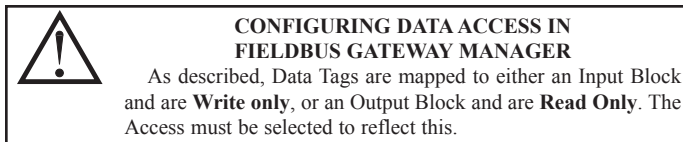

## SOFTWARE/UNIT OPERATION LEDS

The card has 3 LEDs visible on the front of the option card that provide status information, described in Table 1.

DATA (Red)	WD (Green)	DP (Red)	DESCRIPTION
OFF	SLOW ALTERNATING FLASH		Baud Search
OFF	OFF	ON	Baud Control
OFF	SLOW FLASH	FAST FLASH	Waiting for Parameter Telegram
OFF	FAST FLASH	SLOW FLASH	Waiting for Configuration Telegram
ON	OFF	OFF	Data Exchange

## TROUBLESHOOTING YOUR VFG9000-PBDP OPTION CARD

If for any reason you have trouble operating, connecting, or simply have questions concerning your new VFG9000-PBDP option card, contact B&B Electronics' technical support. For contact information, refer to the back page of this bulletin for phone and fax numbers.

Web Site: <http://www.bb-elec.com>

