

Order Code	TCK-121
Inductance	15 μ H \pm 20% (at 100 kHz / 1 V)
Impedance (DCR)	570 m Ω max.
Rated Current	0.7 A max.
Operating Temperature	-40°C to +125°C
RoHS Exemptions	No Exemptions

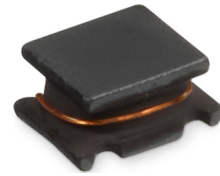

Impedance Curve

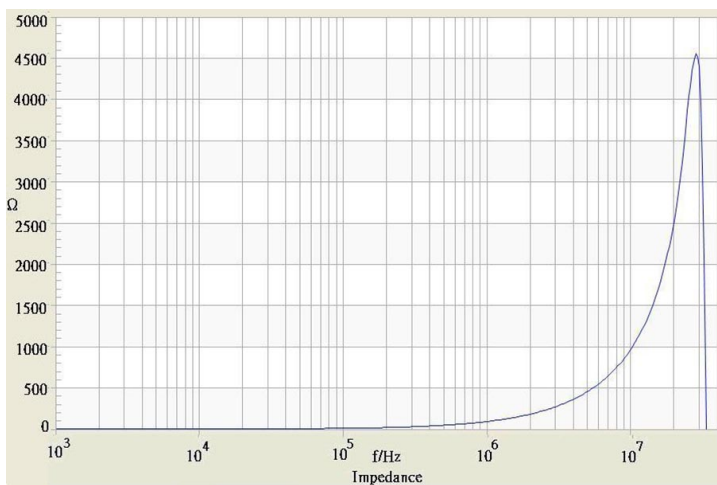

Outline Dimensions

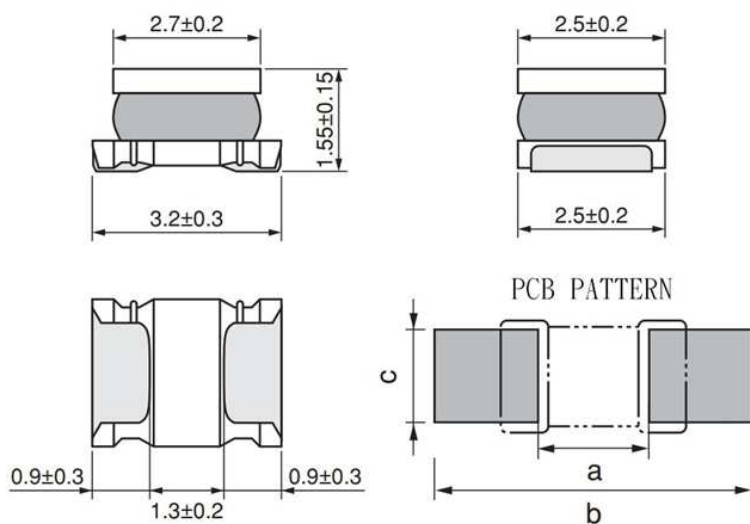

Dimensions [mm]	
a	1.9
b	3.6
c	2.7

All specifications valid at +25°C, unless otherwise stated.