

## TINA-M

~30° medium beam. Assembly with holder, installation tape and location pins.

### TECHNICAL SPECIFICATIONS:

Dimensions	Ø 16.1 mm
Height	9.5 mm
Fastening	pin, tape
ROHS compliant	yes ⓘ



### MATERIAL SPECIFICATIONS:

Component	Type	Material	Colour	Finish
TINA-M	Single lens	PMMA	clear	
TINA-HLD-PIN-BLK	Holder	PC	black	
TINA-TAPE3	Tape	Acrylic foam	black	

### ORDERING INFORMATION:

Component		Qty in box	MOQ	MPQ	Box weight (kg)
FA11206_TINA-M	Single lens	2016	288	144	4.1
» Box size:					

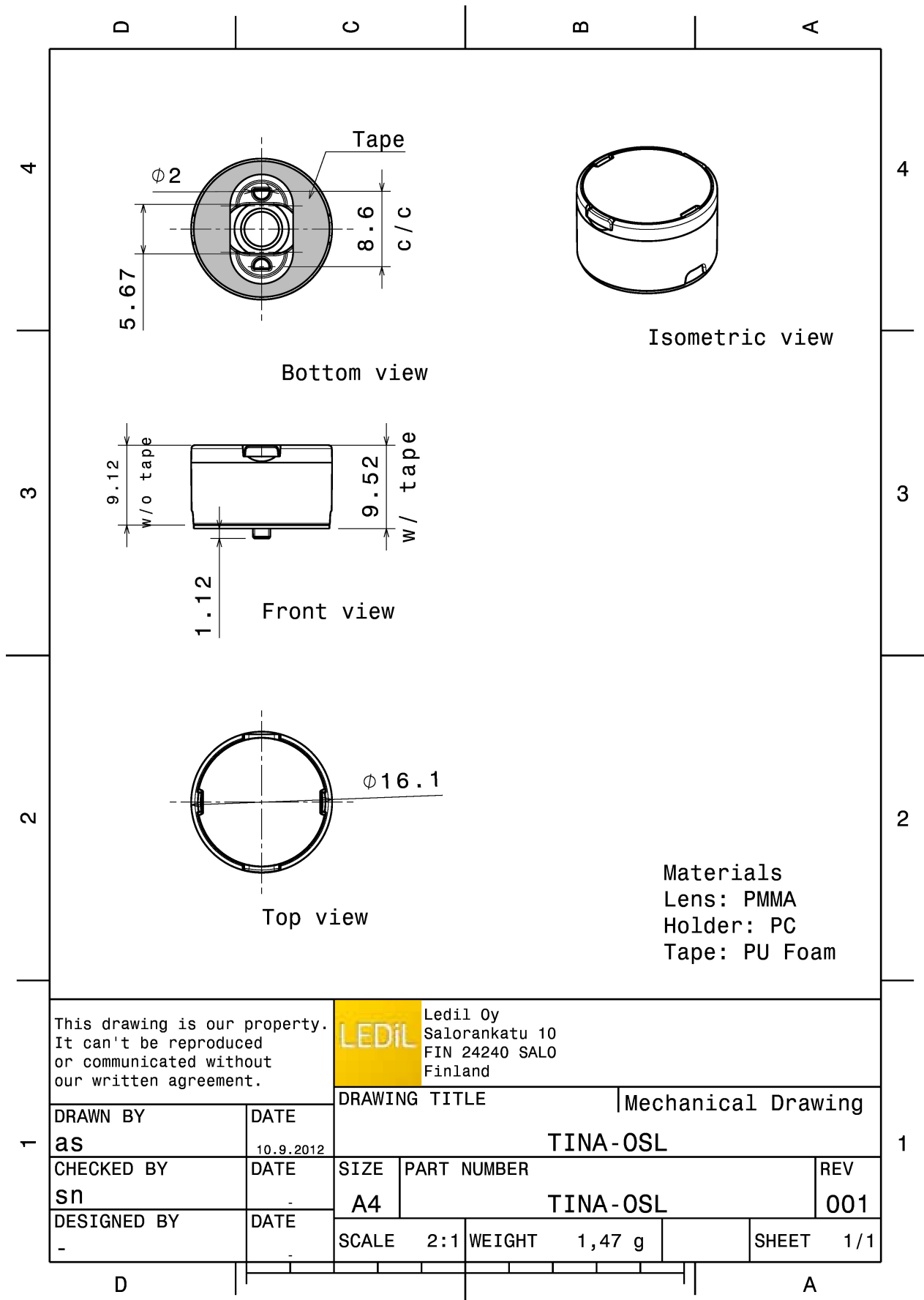

This drawing is our property. It can't be reproduced or communicated without our written agreement.

**LEDiL** Ledil Oy  
 Salorankatu 10  
 FIN 24240 SALO  
 Finland

DRAWN BY <b>as</b>		DATE 10.9.2012	DRAWING TITLE <b>TINA-OSL</b>		Mechanical Drawing
CHECKED BY <b>sn</b>	DATE -	SIZE <b>A4</b>	PART NUMBER <b>TINA-OSL</b>	REV <b>001</b>	
DESIGNED BY -	DATE -	SCALE <b>2:1</b>	WEIGHT <b>1,47 g</b>	SHEET <b>1/1</b>	

See also our general installation guide: [www.ledil.com/installation\\_guide](http://www.ledil.com/installation_guide)

#### PHOTOMETRIC DATA (MEASURED):

**CREE** 

LED XB-H  
 FWHM / FWTM 31.0° / 58.0°  
 Efficiency 80 %  
 Peak intensity 2.3 cd/lm  
 LEDs/each optic 1  
 Light colour White  
 Required components:

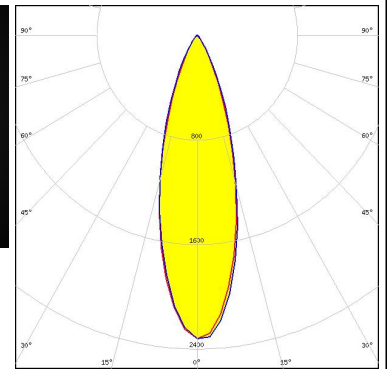
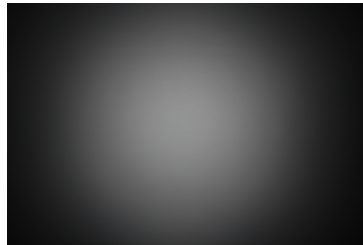

**NICHIA** 

LED NVSW3x9A  
 FWHM / FWTM 31.0° / 60.0°  
 Efficiency 78 %  
 Peak intensity 2.1 cd/lm  
 LEDs/each optic 1  
 Light colour White  
 Required components:

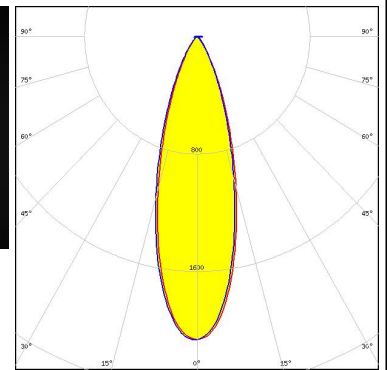
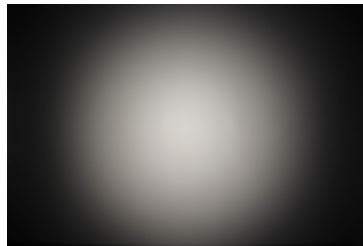

**OSRAM**  
Opto Semiconductors

LED Duris S5 (2 chip)  
 FWHM / FWTM 29.0° / 58.0°  
 Efficiency 82 %  
 Peak intensity 2.4 cd/lm  
 LEDs/each optic 1  
 Light colour White  
 Required components:

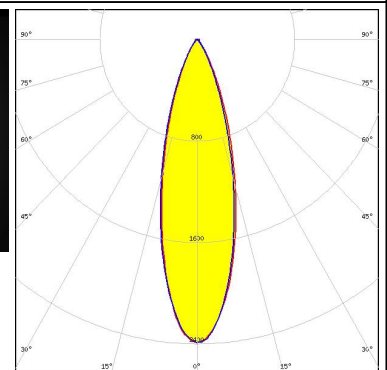
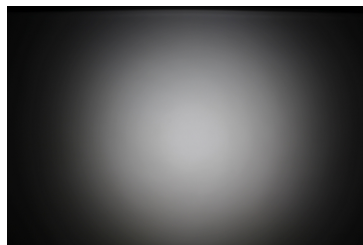

**OSRAM**  
Opto Semiconductors

LED OSLOM SSL 150  
 FWHM / FWTM 30.0° / 54.0°  
 Efficiency 85 %  
 Peak intensity 2 cd/lm  
 LEDs/each optic 1  
 Light colour White  
 Required components:

## PHOTOMETRIC DATA (MEASURED):

### OSRAM

Opto Semiconductors

LED OSLON SSL 80  
FWHM / FWTM 24.0° / 56.0°  
Efficiency 83 %  
Peak intensity 2.3 cd/lm  
LEDs/each optic 1  
Light colour White  
Required components:

### OSRAM

Opto Semiconductors

LED SFH 4715S  
FWHM / FWTM 28.0° / 56.0°  
Efficiency %  
LEDs/each optic 1  
Light colour White  
Required components:

### OSRAM

Opto Semiconductors

LED SFH 4725S  
FWHM / FWTM 27.0° / 58.0°  
Efficiency %  
LEDs/each optic 1  
Light colour White  
Required components:

### SAMSUNG

LED LH351A  
FWHM / FWTM 32.0° / 60.0°  
Efficiency 91 %  
Peak intensity 1.5 cd/lm  
LEDs/each optic 1  
Light colour White  
Required components:

### PHOTOMETRIC DATA (MEASURED):



### PHOTOMETRIC DATA (SIMULATED):

<p><b>LUMILEDS</b></p> <p>LED LUXEON SunPlus 20 Line (150 deg)</p> <p>FWHM / FWTM 30.0° / 53.0°</p> <p>Efficiency 89 %</p> <p>Peak intensity 3 cd/lm</p> <p>LEDs/each optic 1</p> <p>Light colour White</p> <p>Required components:</p>	
<p><b>NICHIA</b></p> <p>LED NCSxE17A</p> <p>FWHM / FWTM 33.0° / 65.0°</p> <p>Efficiency 79 %</p> <p>Peak intensity 1.8 cd/lm</p> <p>LEDs/each optic 4</p> <p>Light colour White</p> <p>Required components:</p>	
<p><b>NICHIA</b></p> <p>LED NVSxx19B/NVSxx19C</p> <p>FWHM / FWTM 30.0°</p> <p>Efficiency 86 %</p> <p>Peak intensity 2.7 cd/lm</p> <p>LEDs/each optic 1</p> <p>Light colour White</p> <p>Required components:</p>	
<p><b>OSRAM</b> Opto Semiconductors</p> <p>LED SYNIOS S2222 (KW DDLM31)</p> <p>FWHM / FWTM 28.0° / 50.0 + 52.0°</p> <p>Efficiency 97 %</p> <p>Peak intensity 3.5 cd/lm</p> <p>LEDs/each optic 1</p> <p>Light colour White</p> <p>Required components:</p>	

### GENERAL INFORMATION:

NOTE: The typical beam angle will be changed by different color, chip size and chip position tolerance. The typical total beam angle is the full angle measured where the luminous intensity is half of the peak value.

### MATERIALS:

As part of our continuous research and improvement processes, and to ensure the best possible quality and availability of our products, LEDiL reserves the right to change material grades without notice.

### PRODUCT DATA USER AGREEMENT AND DISCLAIMER:

The measured data in the provided downloadable LEDiL Product Datasheets and Mechanical 2D-Drawings is rounded and provided as reference for planning. LEDiL Oy's optical specifications have been verified by conducting performance testing of the products in accordance with the company's quality system. The reported data are averaged results of multiple measurements with typical variation. LEDiL Oy reserves the right to without prior notification make changes and improvements to its products.

LEDiL Oy assumes neither warranty, nor guarantee nor any other liability of any kind for the contents and correctness of the provided data. The provided data has been generated with highest diligence but the provided data may in reality not represent the complete possible variation range of all intrinsic parameters. Therefore, in certain cases a deviation from the provided data could occur.

LEDiL Oy reserves the right to undertake technical changes of its products without further notification which could lead to changes in the provided data. LEDiL Oy assumes no liability of any kind for the possible deviation from any provided data or any other damage resulting from the usage of the provided data.

The user agrees to this disclaimer and user agreement with the download or usage of the provided files.

#### LEDiL Oy

Joensuunkatu 13  
FI-24240 SALO  
Finland

#### LEDiL Inc.

228 West Page Street  
Suite D  
Sycamore IL 60178  
USA

#### Ledil Optics Technology (Shenzhen) Co., Ltd.

# 405 , Block B  
Casic Motor Building  
Shenzhen 518057  
P.R.CHINA

#### Local sales and technical support

[www.ledil.com/  
where\\_to\\_buy](http://www.ledil.com/where_to_buy)

#### Shipping locations

Salo, Finland  
Hong Kong, China

#### Distribution Partners

[www.ledil.com/  
where\\_to\\_buy](http://www.ledil.com/where_to_buy)