

LR2-W

~40° wide beam optimized for LUXEON Rebel ES. 14.8 mm high assembly with installation tape.

SPECIFICATION:

Dimensions	Ø 21.6 mm
Height	14.8 mm
Fastening	tape, pin
ROHS compliant	yes ⓘ

MATERIALS:

Component	Type	Material	Colour	Finish
LXP2-W	Single lens	PMMA		
LR2-ES-LH1-HLD	Holder	PC	white	
HEIDI-TAPE	Tape	Acrylic foam	black	

ORDERING INFORMATION:



Component		Qty in box	MOQ	MPQ	Box weight (kg)
CA12394_LR2-W	Single lens	1680	336	112	9.4
» Box size: 480 x 280 x 300 mm					

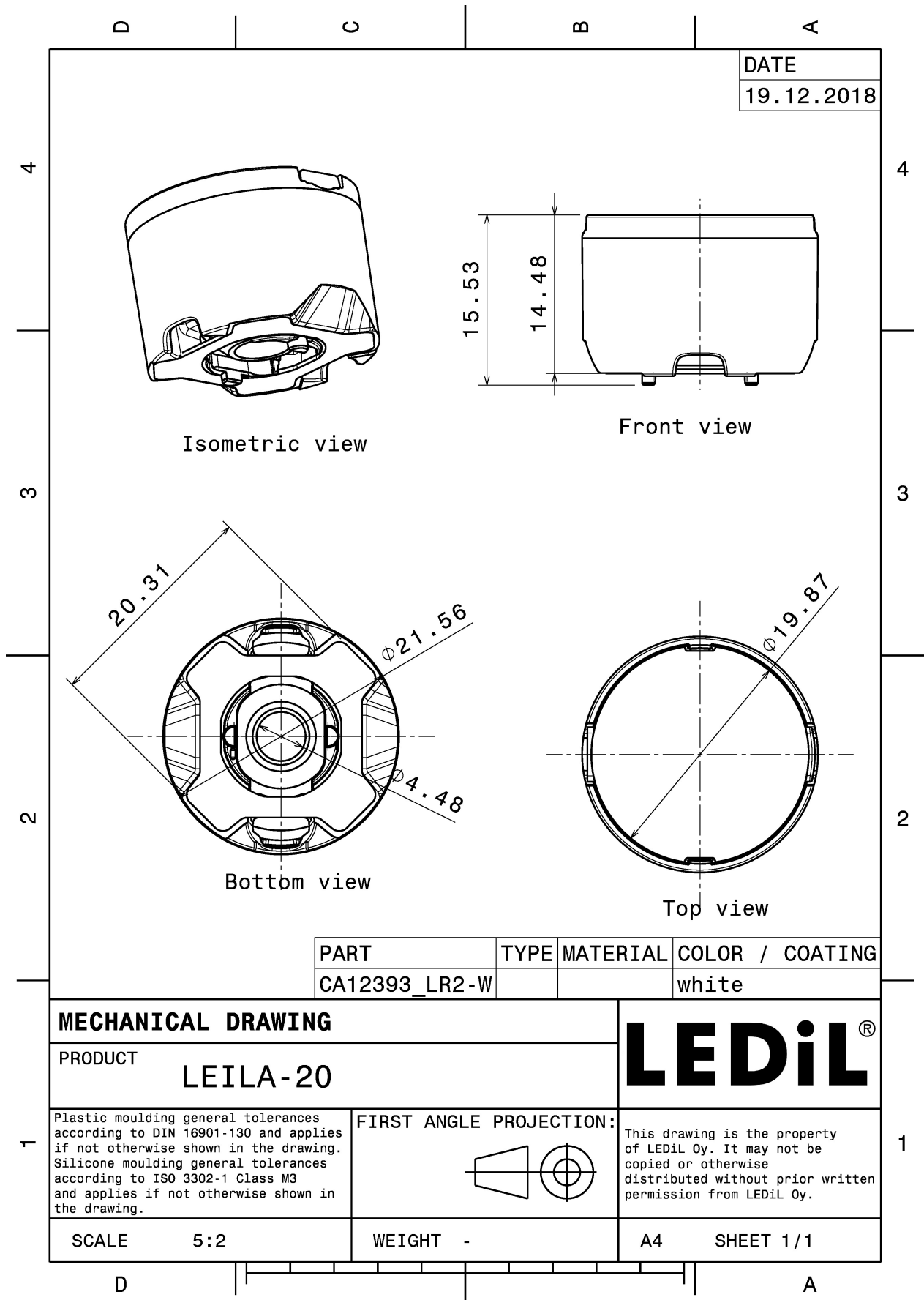

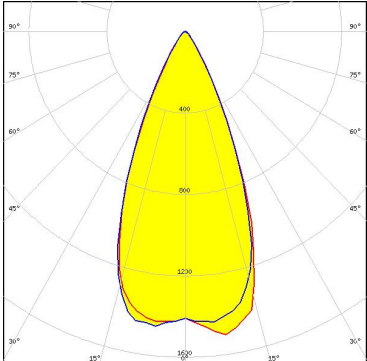
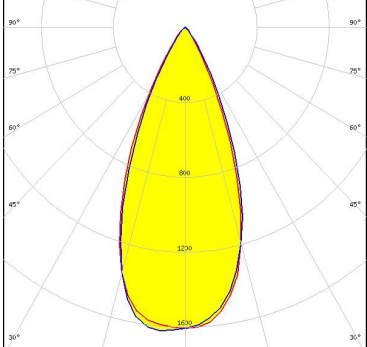

See also our general installation guide: www.ledil.com/installation_guide

OPTICAL RESULTS (MEASURED):

<p>LUMILEDS</p> <p>LED LUXEON T</p> <p>FWHM / FWTM 46.0° / 69.0°</p> <p>Efficiency 89 %</p> <p>Peak intensity 1.4 cd/lm</p> <p>LEDs/each optic 1</p> <p>Light colour White</p> <p>Required components:</p>	
<p>LUMILEDS</p> <p>LED LUXEON TX</p> <p>FWHM / FWTM 45.0° / 68.0°</p> <p>Efficiency 90 %</p> <p>Peak intensity 1.6 cd/lm</p> <p>LEDs/each optic 1</p> <p>Light colour White</p> <p>Required components:</p>	
<p>LUMILEDS</p> <p>LED LUXEON Z ES</p> <p>FWHM / FWTM 43.0° / 64.0°</p> <p>Efficiency 88 %</p> <p>Peak intensity 1.8 cd/lm</p> <p>LEDs/each optic 1</p> <p>Light colour White</p> <p>Required components:</p>	
<p>OSRAM Opto Semiconductors</p> <p>LED SFH 4770S</p> <p>FWHM / FWTM 39.0° / 62.0°</p> <p>Efficiency 92 %</p> <p>LEDs/each optic 1</p> <p>Light colour IR</p> <p>Required components:</p>	

OPTICAL RESULTS (SIMULATED):

CREE LED

LED J Series 5050 Round LES
 FWHM / FWTM 50.0° / 76.0°
 Efficiency 96 %
 Peak intensity 1.3 cd/lm
 LEDs/each optic 1
 Light colour White
 Required components:

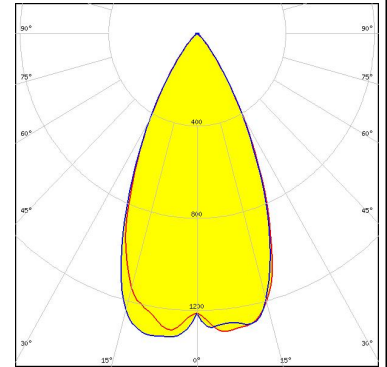

CREE LED

LED XP-G3
 FWHM / FWTM 46.0° / 68.0°
 Efficiency 93 %
 Peak intensity 1.6 cd/lm
 LEDs/each optic 1
 Light colour Red
 Required components:

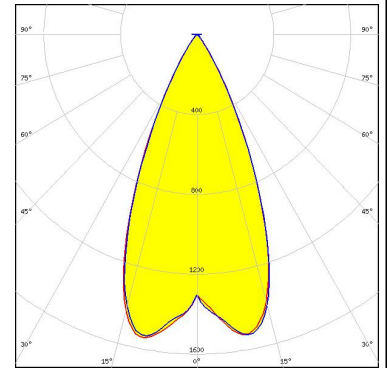

CREE LED

LED XQ-E HD
 FWHM / FWTM 48.0° / 64.0°
 Efficiency 95 %
 Peak intensity 1.7 cd/lm
 LEDs/each optic 1
 Light colour White
 Required components:

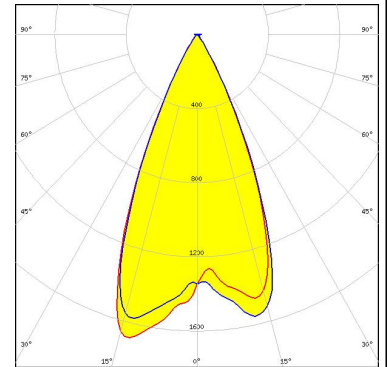

LUMILEDS

LED LUXEON 5050 Round LES
 FWHM / FWTM 50.0° / 76.0°
 Efficiency 96 %
 Peak intensity 1.4 cd/lm
 LEDs/each optic 1
 Light colour White
 Required components:

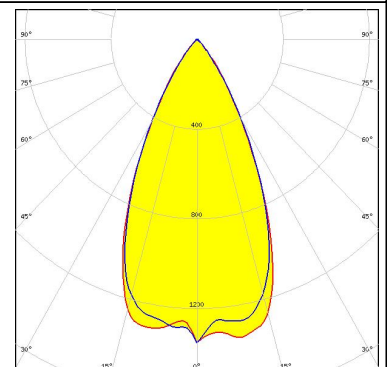

OPTICAL RESULTS (SIMULATED):

LUMILEDS

LED LUXEON 5050 Square LES
 FWHM / FWTM 52.0° / 78.0°
 Efficiency 96 %
 Peak intensity 1.3 cd/lm
 LEDs/each optic 1
 Light colour White
 Required components:

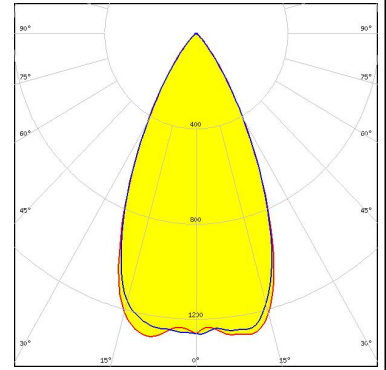

LUMILEDS

LED LUXEON Rebel ES
 FWHM / FWTM 48.0° / 66.0°
 Efficiency 95 %
 Peak intensity 1.6 cd/lm
 LEDs/each optic 1
 Light colour White
 Required components:

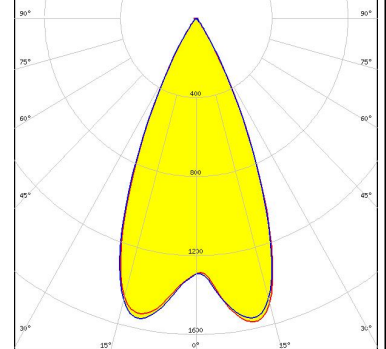

LUMILEDS

LED LUXEON V2
 FWHM / FWTM 43.0° / 60.0°
 Efficiency 94 %
 Peak intensity 1.7 cd/lm
 LEDs/each optic 1
 Light colour White
 Required components:

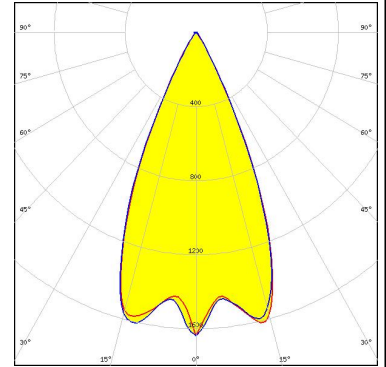

NICHIA

LED NV4WB35AM
 FWHM / FWTM 50.0° / 70.0°
 Efficiency 96 %
 Peak intensity 1.5 cd/lm
 LEDs/each optic 1
 Light colour White
 Required components:

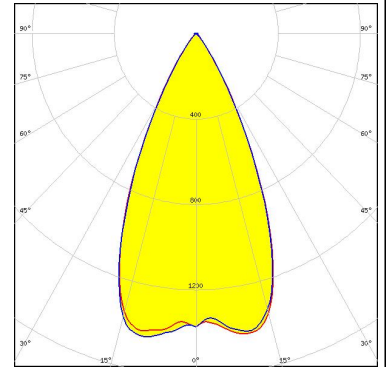

OPTICAL RESULTS (SIMULATED):

OSRAM Opto Semiconductors

LED OSCONIQ P 3030
 FWHM / FWTM 44.0° / 62.0°
 Efficiency 95 %
 Peak intensity 1.9 cd/lm
 LEDs/each optic 1
 Light colour Blue
 Required components:

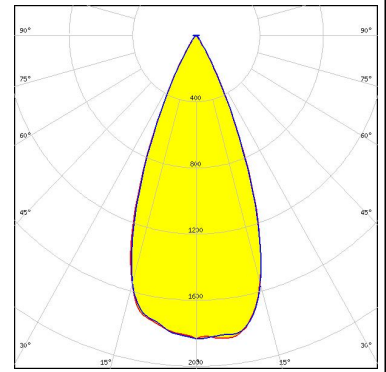

OSRAM Opto Semiconductors

LED OSLOM Square CSSRM2/CSSRM3
 FWHM / FWTM 47.0° / 66.0°
 Efficiency 96 %
 Peak intensity 1.6 cd/lm
 LEDs/each optic 1
 Light colour White
 Required components:

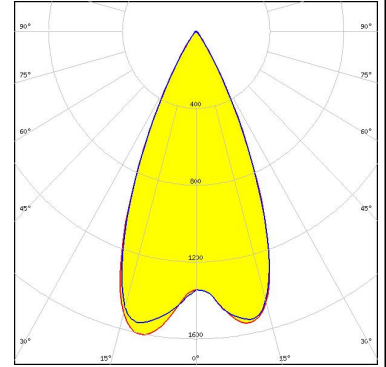

OSRAM Opto Semiconductors

LED SFH 4715AS
 FWHM / FWTM 46.0° / 64.0°
 Efficiency 95 %
 LEDs/each optic 1
 Light colour IR
 Required components:

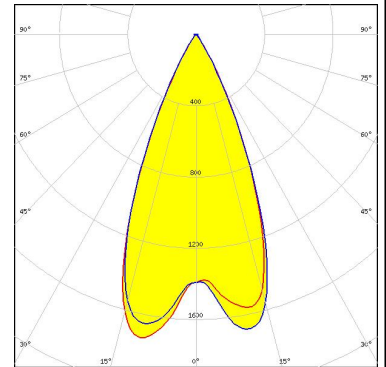

OSRAM Opto Semiconductors

LED SFH 4716AS
 FWHM / FWTM 38.0° / 58.0°
 Efficiency 94 %
 LEDs/each optic 1
 Light colour IR
 Required components:

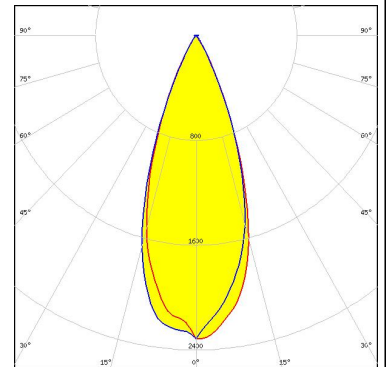

GENERAL INFORMATION:

NOTE: The typical beam angle will be changed by different color, chip size and chip position tolerance. The typical total beam angle is the full angle measured where the luminous intensity is half of the peak value.

MATERIALS:

As part of our continuous research and improvement processes, and to ensure the best possible quality and availability of our products, LEDiL reserves the right to change material grades without notice.

PRODUCT DATA USER AGREEMENT AND DISCLAIMER:

The measured data in the provided downloadable LEDiL Product Datasheets and Mechanical 2D-Drawings is rounded and provided as reference for planning. LEDiL Oy's optical specifications have been verified by conducting performance testing of the products in accordance with the company's quality system. The reported data are averaged results of multiple measurements with typical variation. LEDiL Oy reserves the right to without prior notification make changes and improvements to its products.

LEDiL Oy assumes neither warranty, nor guarantee nor any other liability of any kind for the contents and correctness of the provided data. The provided data has been generated with highest diligence but the provided data may in reality not represent the complete possible variation range of all intrinsic parameters. Therefore, in certain cases a deviation from the provided data could occur.

LEDiL Oy reserves the right to undertake technical changes of its products without further notification which could lead to changes in the provided data. LEDiL Oy assumes no liability of any kind for the possible deviation from any provided data or any other damage resulting from the usage of the provided data.

The user agrees to this disclaimer and user agreement with the download or usage of the provided files.

LEDiL Oy

Joensuunkatu 13
FI-24240 SALO
Finland

LEDiL Inc.

228 West Page Street
Suite D
Sycamore IL 60178
USA

Ledil Optics Technology (Shenzhen) Co., Ltd.

405 , Block B
Casic Motor Building
Shenzhen 518057
P.R.CHINA

Local sales and technical support

[www.ledil.com/
where_to_buy](http://www.ledil.com/where_to_buy)

Shipping locations

Salo, Finland
Hong Kong, China

Distribution Partners

[www.ledil.com/
where_to_buy](http://www.ledil.com/where_to_buy)