



USB 3.0 Spectra™ 3022

2-Port USB 3.0 100m Multimode Fiber Extender System

User Guide



Thank you for purchasing the USB 3.0 Spectra™ 3022.

Please read this guide thoroughly.

This document applies to Part Numbers: 00-00327, 00-00328, 00-00329, and 00-00330.

FCC Radio Frequency Interference Statement Warning

This device complies with Part 15 of the FCC rules. Operation is subject to the following two conditions: (1) this device may not cause harmful interference, and (2) this device must accept any interference received including interference that may cause undesired operation.

CE Statement

We, Icron Technologies Corporation, declare under our sole responsibility that the Spectra 3022, to which this declaration relates, is in conformity with European Standard EN 55022, EN 55024, EN 61000-3-2, and EN 61000-3-3.

IC Statement

This Class B digital apparatus complies with Canadian ICES-003.

©2013 Icron Technologies Corporation. All rights reserved. Icron Technologies Corporation, the Icron Technologies Corporation logo, and the Icron Technologies Corporation products referred to herein are either the trademarks or the registered trademarks of Icron Technologies Corporation. All other trademarks are property of their respective owners. Icron Technologies Corporation assumes no responsibility for errors that may appear in this manual. Information contained herein is subject to change without notice.

Document #90-01057-A02

Contents

| | |
|-------------------------------------------|-----------|
| Introduction | 3 |
| Spectra 3022 Product Contents | 3 |
| Features | 3 |
| The LEX Unit | 4 |
| The REX Unit..... | 5 |
| Installation Guide | 6 |
| Requirements | 6 |
| Fiber Optic Link Cabling..... | 6 |
| Installing the Spectra 3022 System..... | 7 |
| Preparing Your Site | 7 |
| Preparing Your Computer..... | 7 |
| Connecting a USB 3.0 Device..... | 11 |
| Installing the REX Unit | 11 |
| Installing the LEX Unit | 11 |
| Checking the Installation | 12 |
| Compatibility | 12 |
| Troubleshooting | 13 |
| Contacting Technical Support | 15 |
| Warranty Information | 15 |
| Obtaining Warranty Service | 16 |
| Contacting Sales | 16 |
| Contacting Technical Support | 16 |
| Technical Glossary | 17 |
| USB Connectors | 17 |
| Duplex LC Crossover | 17 |
| Specifications..... | 18 |

Introduction

This guide provides product information for the Spectra 3022, installation instructions, troubleshooting guidelines, and instructions for contacting Icron regarding technical support and warranty information.

The instructions in this guide assume a general knowledge of computer installation procedures, familiarity with cabling requirements, and some understanding of USB devices.

 NOTE: Notes provide additional information that could be useful.

 CAUTION: Cautions provide important information about an operational requirement.

Spectra 3022 Product Contents

Your Spectra 3022 is packaged with:

- LEX unit (Local Extender)
- REX unit (Remote Extender)
- REX AC power adapter
- USB 3.0 cable
- Country specific power cable
- Quick Start Guide and Warranty Information

Features

The Spectra 3022 incorporates Icron's patented ExtremeUSB® technology, enabling users to extend beyond the standard 3m cable limit for USB 3.0 peripheral devices. With the Spectra 3022, USB 3.0 devices can be located up to 100 meters from the computer.

The Spectra 3022 is composed of two individual units: the LEX unit and the REX unit.

 CAUTION: The Spectra 3022 supports only USB 3.0 devices. USB 2.0 and 1.1 devices will not function through this extender.

The LEX Unit

The Local Extender (LEX) unit connects to the computer using a standard USB 3.0 cable. Power for this unit is provided by the USB on the host computer.

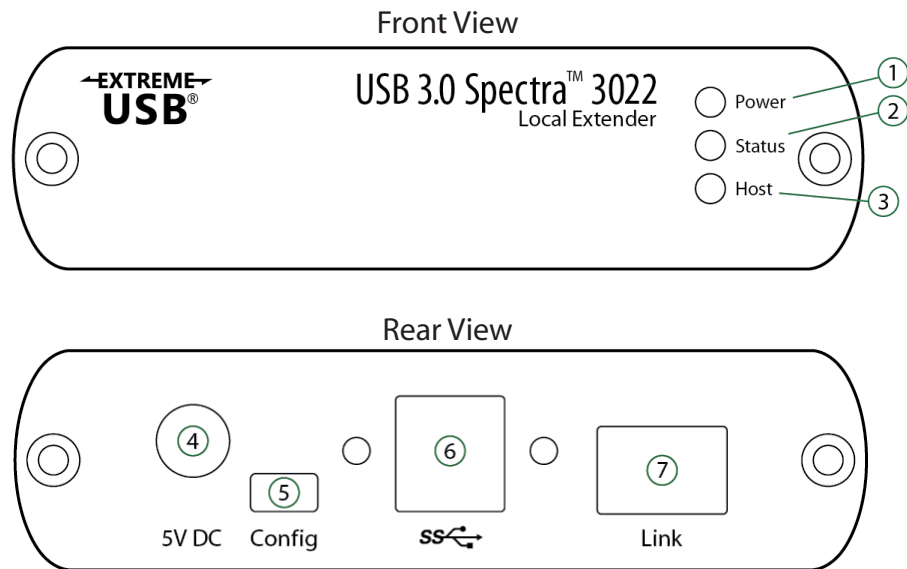

| ITEM | TYPE | DESCRIPTION |
|------|-----------------------|-----------------------------------------------------------------------------------------------------------------------------------------------------------------------------------------------------------|
| 1 | Power ON | Unit is powered properly. |
| | Power OFF | Unit is not powered or not powered properly. |
| 2 | Status Blinking (1Hz) | Waiting for connection to REX. |
| | Status ON | LEX/REX are linked and operating normally. |
| | Status OFF | Fault detected; power cycle required. |
| 3 | Host ON | SuperSpeed Host detected on upstream facing port. |
| | Host OFF | SuperSpeed Host not detected. |
| 4 | Power Port (optional) | Not required in normal operation. An optional 5V power supply can be connected to the LEX unit to provide power if the USB port on the host PC is not capable of delivering sufficient power to the unit. |
| 5 | Config Port | Reserved for manufacturer use. |
| 6 | USB 3.0 Type B port | Used to connect the LEX unit to the host computer. Port accepts locking or non-locking USB 3.0 Type B connectors. |
| 7 | Link Port (Duplex LC) | Extension link Duplex LC fiber optic transceiver port. |

The REX Unit

The Remote Extender (REX) unit provides USB Type A ports for USB 3.0 devices. The REX unit allows you to connect up to two USB 3.0 devices directly. The REX unit is powered by an external AC adapter and can supply up to 900mA to each USB port.

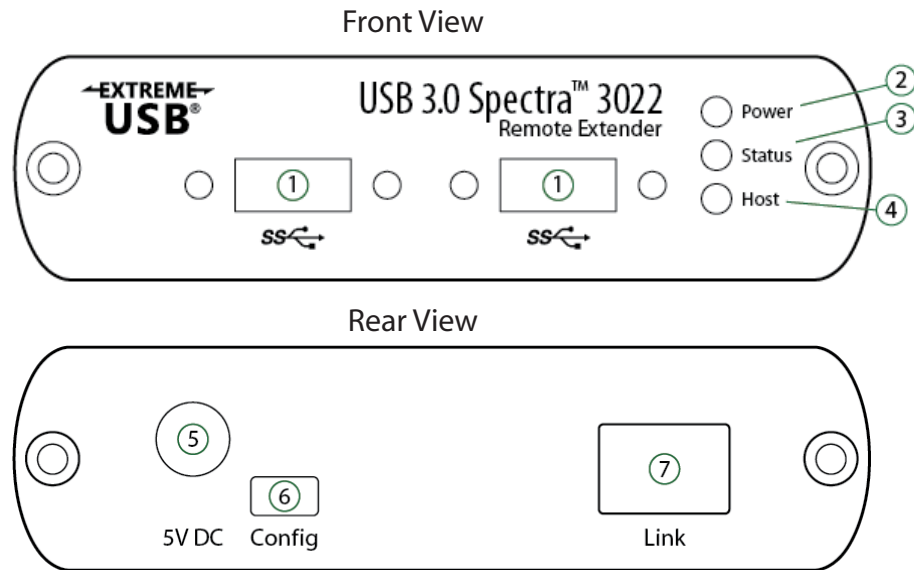

| ITEM | TYPE | DESCRIPTION |
|------|-----------------------|-------------------------------------------------------------------------------------------------------------------|
| 1 | USB 3.0 Type A ports | Used to connect USB 3.0 device(s) to the REX unit. Ports accept locking or non-locking USB 3.0 Type A connectors. |
| 2 | Power ON | Unit is powered properly. |
| | Power OFF | Unit is not powered or not powered properly. |
| 3 | Status Blinking (1Hz) | Waiting for connection to LEX. |
| | Status ON | LEX/REX are linked and operating normally. |
| | Status OFF | Fault detected; power cycle required. |
| 4 | Host ON | SuperSpeed Host detected on upstream facing port. |
| | Host OFF | SuperSpeed Host not detected. |
| 5 | Power Port | Connects to the locking AC power supply. Required on REX for proper operation. |
| 6 | Config Port | Reserved for manufacturer use. |
| 7 | Link Port (Duplex LC) | Extension link Duplex LC fiber optic transceiver port. |

Installation Guide

Example Application

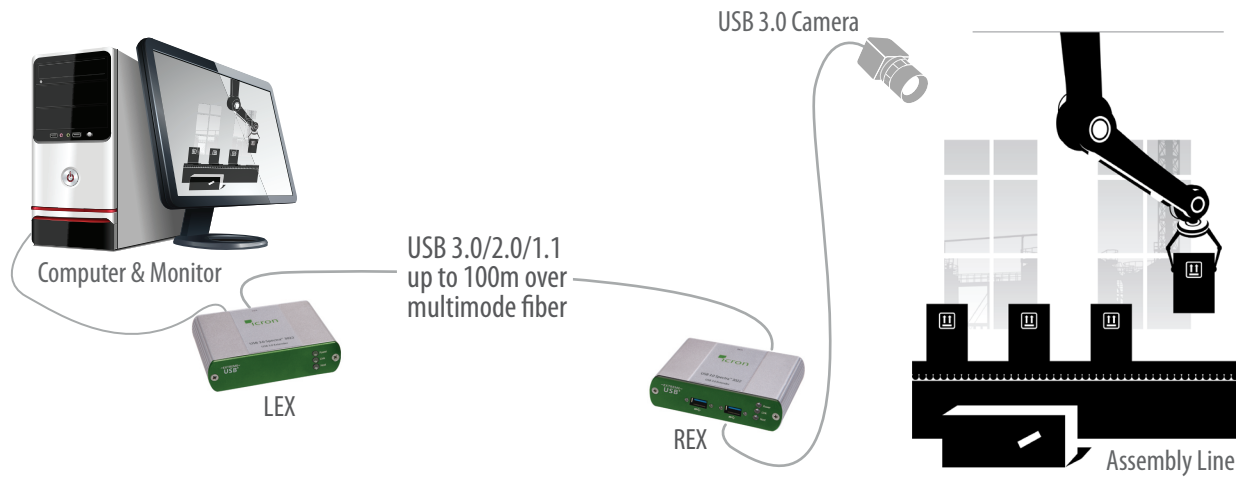

Requirements

To complete installation of the Spectra 3022, you will also require the following items that are not included with the product:

- USB 3.0 compatible computer (host computer) with a USB 3.0 compliant operating system
- USB 3.0 compatible device
- 2-strand 50/125µm multimode (MMF) fiber optic cable with Duplex LC connectors

note The maximum length of the multimode fiber (MMF) optic cable supported by the Spectra 3022 system, including patch cords, is 100m for USB 3.0 cameras, and 50m for other devices.

Fiber Optic Link Cabling

The LEX and REX units are interconnected by fiber optic cabling. This cabling must be:

- 50/125µm multimode fiber (MMF)
- Terminated with Duplex LC connectors

The following maximum distances are achievable depending on the application and cabling standard:

- Using OM3, up to 100m is achievable with USB 3.0 cameras, and up to 50m for all other applications.
- Using OM2, up to 50m is achievable for all applications.

note For assistance sourcing appropriate fibre optic cabling, contact [Icron Technical Support](#).

If premise cabling will be used for the installation, then the distances provided above must be met when measuring from LEX to REX, inclusive of the premise cabling and the patch cables. All cables must meet the ratings specified. Patch cables must be terminated with Duplex LC connectors.

Installing the Spectra 3022 System

Preparing Your Site

Before you can install the Spectra 3022, you need to prepare your site:

1. Determine where the computer is to be located and set up the computer.
2. Determine where you want to locate the USB device(s).
3. Ensure fiber optic cabling is in place, prepared, properly terminated, and within the maximum distances as defined for the cabling standard used.

Preparing Your Computer

The Spectra 3022 does not support suspend modes of operation. As such, your computer should be configured to not go into “suspend mode” or to “suspend” the USB ports.

To perform the changes:

Windows (7/8)

To disable “suspend” settings on your computer:

1. Open Control Panel. Open Power Options.

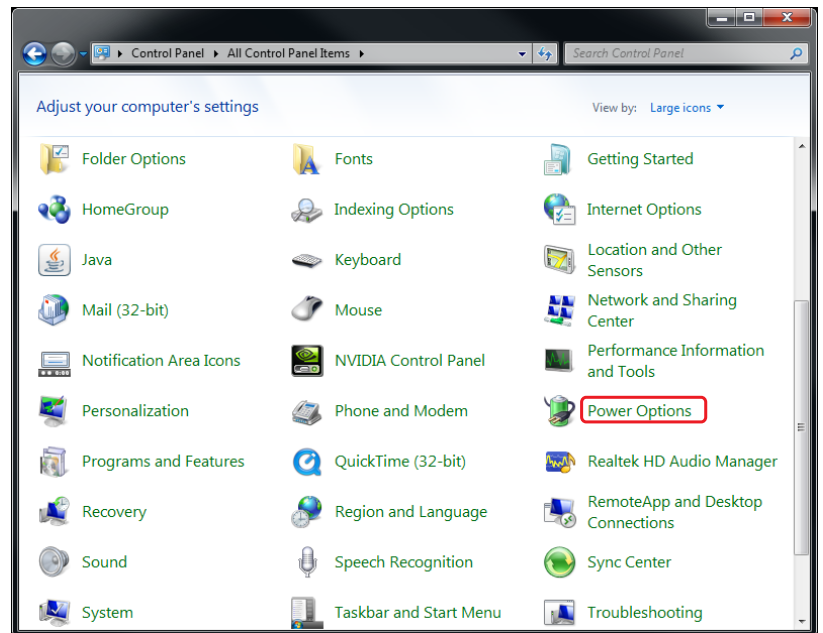
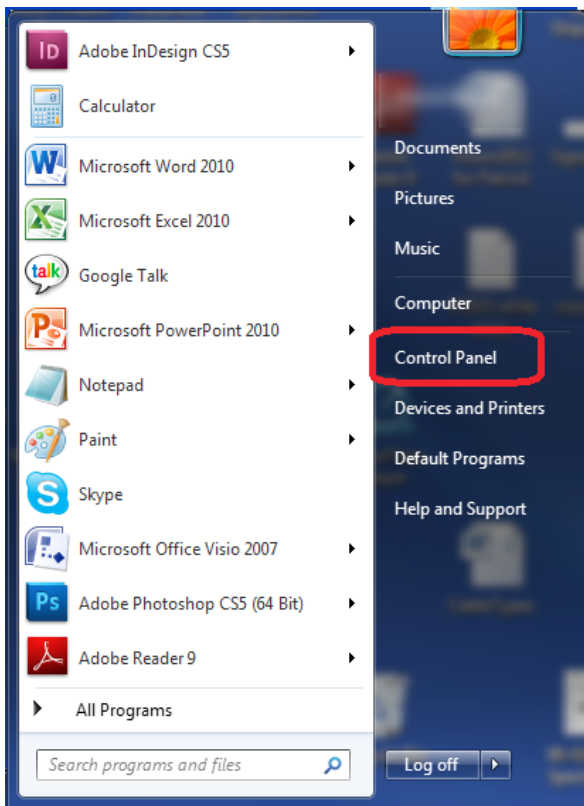

For each of the plans listed:

a. Click on Change Plan Settings

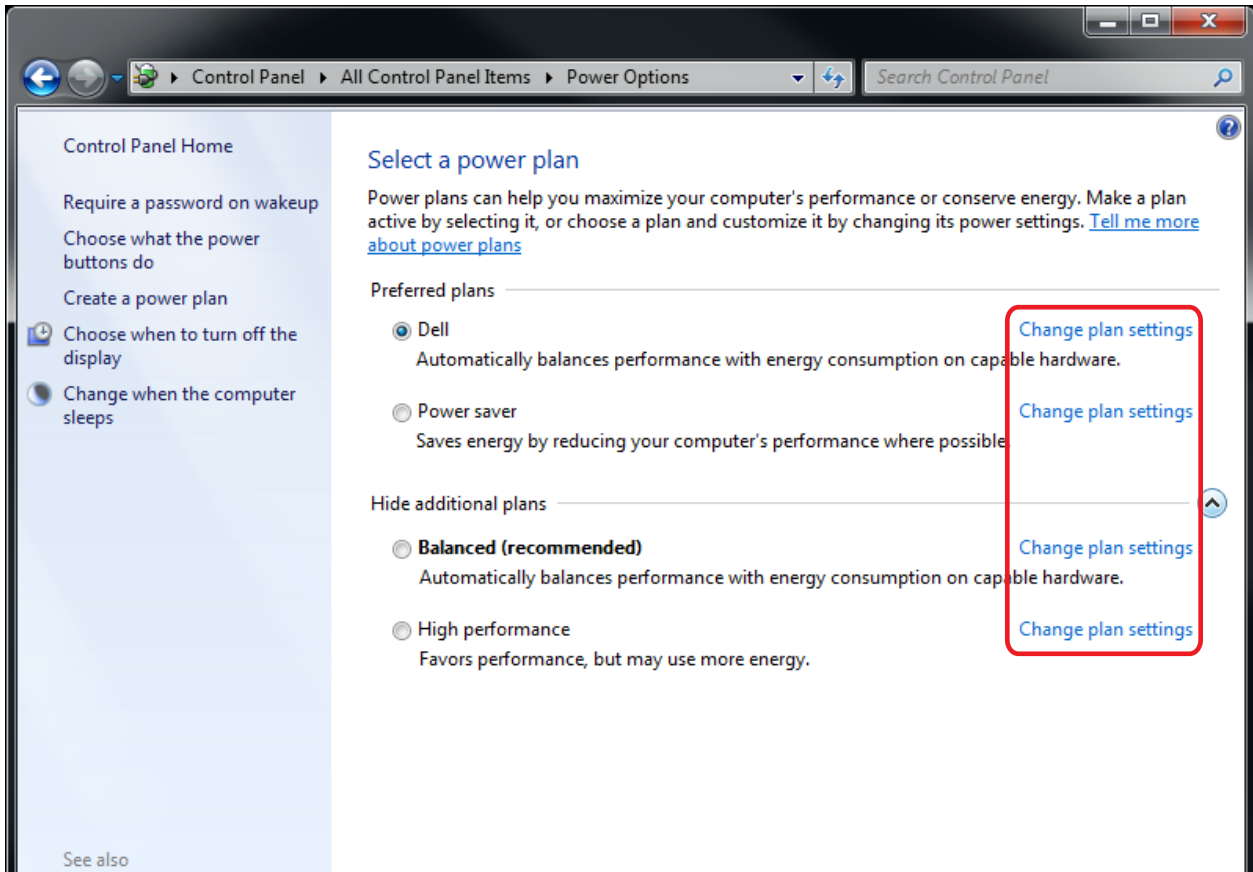

2. Select "Never" for "Put the computer to sleep" for all the configurations presented.

a. Click Change advanced power settings.

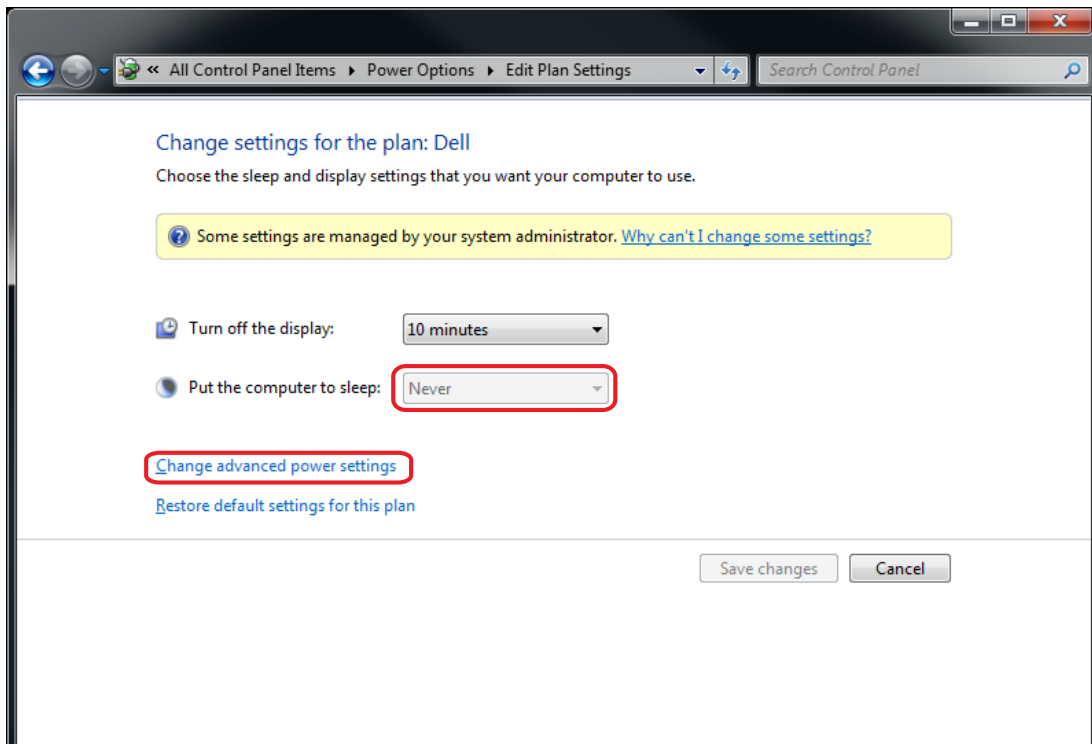

- b. Expand "USB settings"
 - c. Expand "USB selective suspend setting"
3. Select "Disabled"

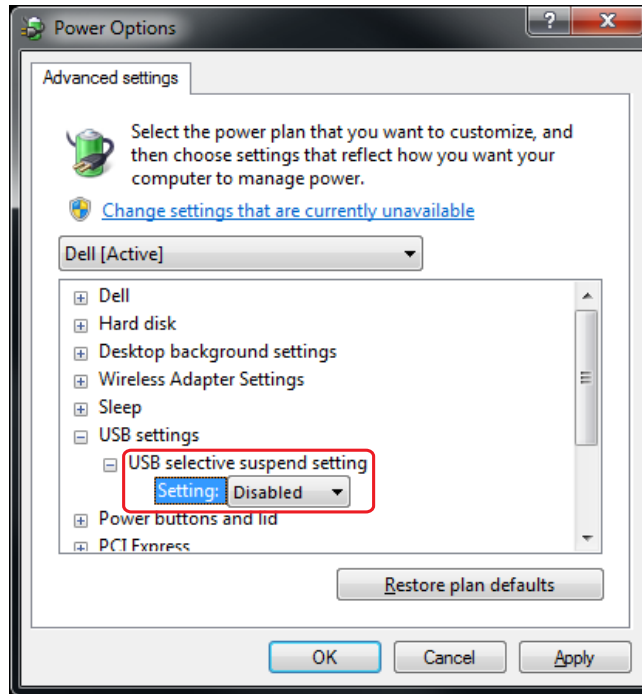

OS X

To disable "suspend" settings on your computer:

- 1. Open System Preferences and select Energy Saver.

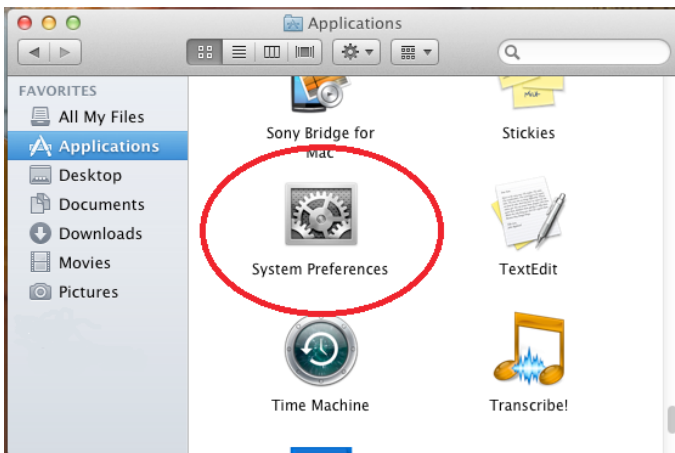

2. For both Battery and Power Adapter power settings, move slider bar to "Never" for "Computer Sleep".

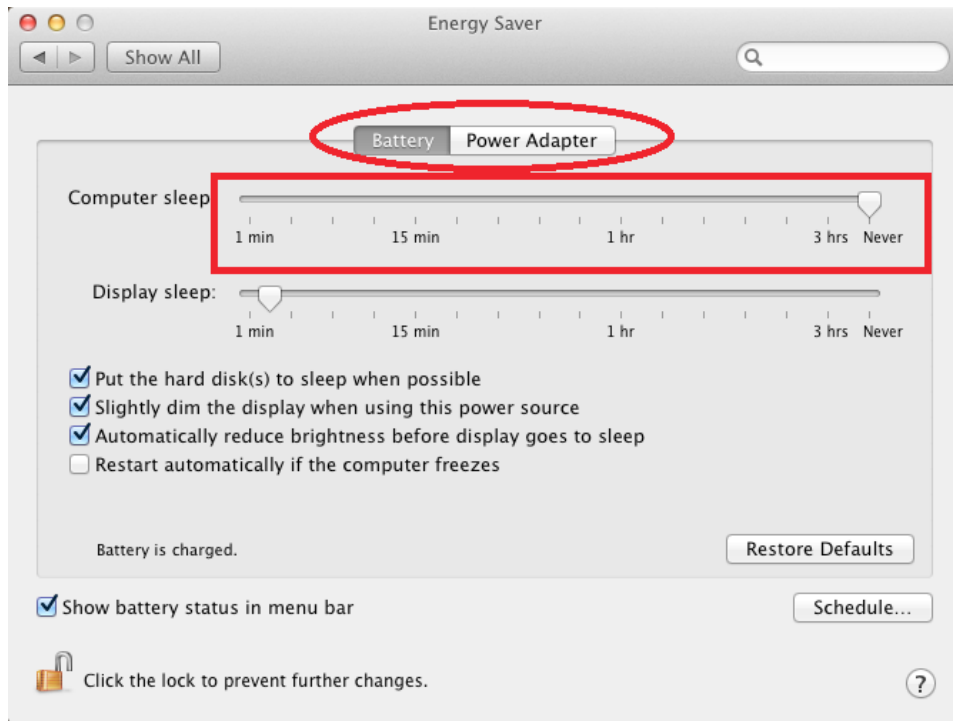

3. In the popup warning window, click OK.

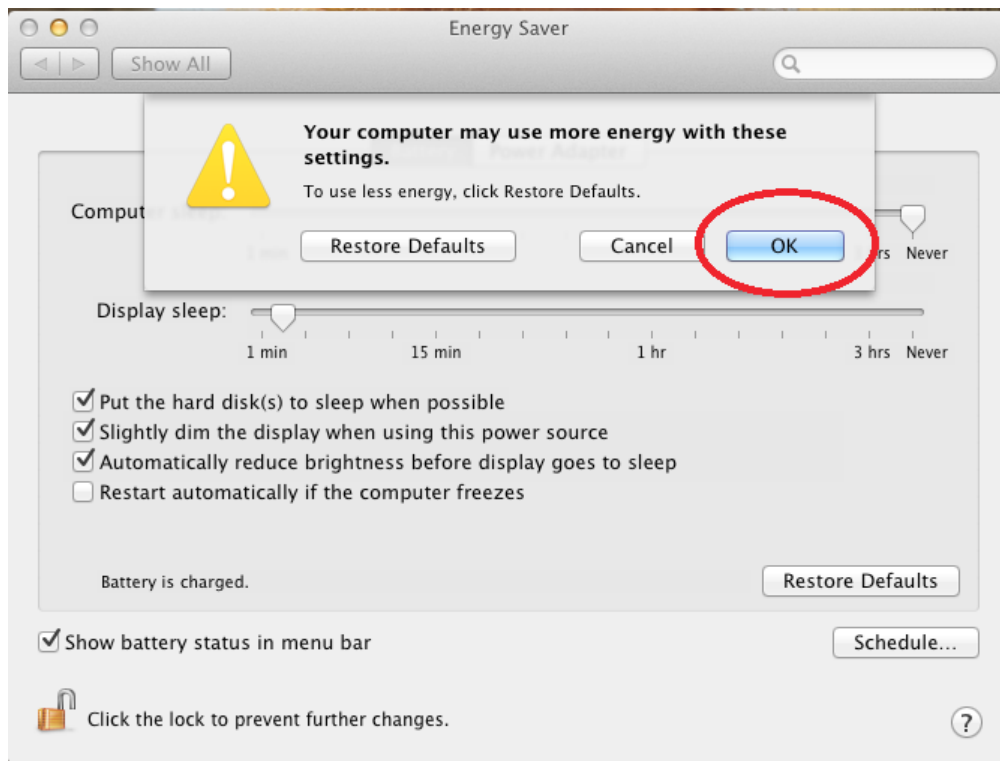

Connecting a USB 3.0 Device

1. Install any software required to operate the USB device(s). Refer to the documentation for the USB device(s), as required.
2. Connect the USB device to the device port on the REX unit. If you are using a USB3 Vision compliant locking USB cable, then you can use the locking knobs to lock the cable to the port on the REX.

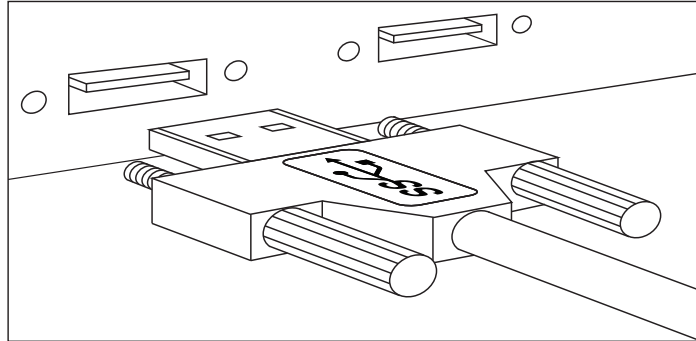

3. Check that the device is detected and installed properly in the operating system.

Installing the REX Unit

1. Place the REX unit near the USB device(s).
2. Plug the power adapter into a suitable AC outlet.
3. Connect the power adapter to the REX unit and twist the connector to lock the power connector into the REX unit.

Installing the LEX Unit

1. Place the LEX unit near the computer.
2. Connect the link cable to the LEX and the REX.

With Surface Cabling

- Plug one end of the fiber optic cabling (not included) into the Link port on the LEX unit.
- Plug the other end of the fiber optic cabling into the Link port on the REX unit.

With Premise Cabling

- Plug one end of a fiber optic patch cord (not included) into the Link port on the LEX unit.
- Plug the other end of the patch cord into the fiber optic information outlet near the host computer.
- Plug one end of the 2nd fiber optic patch cord (not included) into the Link port on the REX unit.
- Plug the other end of the 2nd patch cord into the fiber optic information outlet near the USB device.

3. Install the supplied USB 3.0 cable between the LEX and a USB 3.0 port on the host computer.

! CAUTION: The Spectra 3022 will not operate on a USB 2.0 port; please ensure you connect to a USB 3.0 port. The USB 3.0 port will have a blue connector inside of it, whereas a USB 2.0 port will typically have a black connector inside.

Checking the Installation

1. On the LEX and REX units, check that the Power, Status, and Host LEDs are on and solid. If the Host or Status LEDs are permanently off, then the cabling between the LEX and REX unit may not be installed properly or is defective.
2. For Windows users, open Device Manager to confirm that the Spectra 3022 has installed correctly. Expand the entry for Universal Serial Bus controllers by clicking the + sign. If the Spectra 3022 has been installed correctly, you should find it listed as two "Superspeed Hub"s, or "3.0 Hub"s"

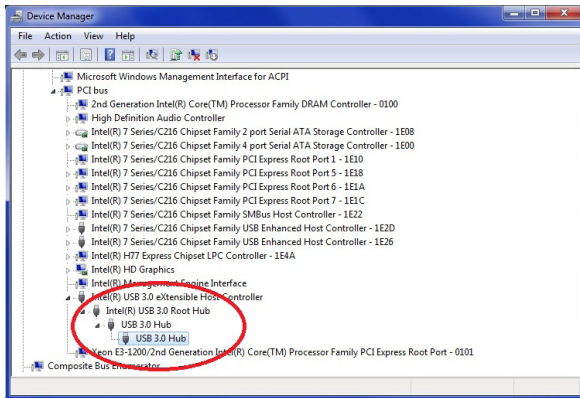

3. For Mac OS X users, open the System Profiler to confirm that the Spectra 3022 has installed correctly. In the left hand column under Hardware, select "USB" and inspect the right hand panel. If the Spectra 3022 has been installed correctly, you should find it listed as a "Hub" under the USB SuperSpeed Bus.

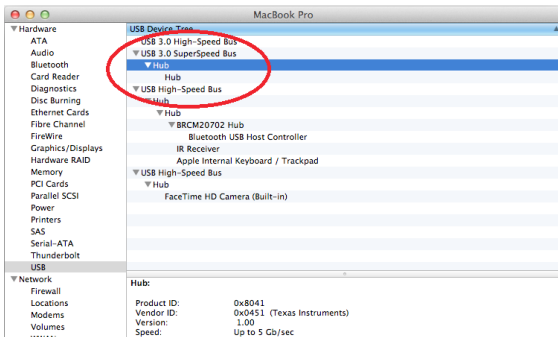

4. If the Spectra 3022 is not detected correctly or fails to detect, please consult the Troubleshooting section in this guide.

note To open System Profiler in OS X: Open the Finder, select Applications, then open the Utilities folder and double click on the System Profiler icon.

To open Device Manager in Windows 8 or Windows 7:

Open the Start menu, right click on "Computer" then select: Manage >> Device Manager

Compatibility

The Spectra 3022 complies with USB 3.0 specifications governing the design of USB devices. However, Icron Technologies Corporation does not guarantee that all USB 3.0 devices are compatible with the Spectra 3022, as there are a number of different configurations that may impact the operation of USB 3.0 devices over extended distances.

! CAUTION: The Spectra 3022 supports only USB 3.0 devices. USB 2.0 and 1.1 devices will not function through this extender.

Troubleshooting

The following table provides troubleshooting tips. The topics are arranged in the order in which they should be executed in most situations. If you are unable to resolve the problem after following these instructions, please contact [Technical Support](#) for further assistance.

| PROBLEM | CAUSE | SOLUTION |
|---------------------------------------------------|--------------------------------------------------------------------------------------------------------------------------------------------------------------------------------------------------------------------------|------------------------------------------------------------------------------------------------------------------------------------------------------------------------------------------------------------------------------------------------------------------------------------------------------------------------------------------------------------------------------------------------------------------------------------------------------------------------------------------------------------------------------------------------|
| All LEDs on LEX unit are off. | <ul style="list-style-type: none"> The LEX unit is not receiving power from the USB port or the (optional) LEX AC adapter. | <ol style="list-style-type: none"> Ensure that the USB connection between the LEX and host computer is properly installed. Move the USB connector to another USB port on the host computer. |
| All LEDs on REX unit are off. | <ul style="list-style-type: none"> The REX unit is not receiving power from the AC adapter. | <ol style="list-style-type: none"> Ensure that the AC power adapter is properly connected to the REX unit. Check that the AC adapter is connected to a live source of electrical power. |
| Status LEDs on both the LEX and REX are blinking. | <ul style="list-style-type: none"> There is no connection between the LEX unit and REX unit. The LEX unit is not connected to a USB 3.0 port The host computer does not support USB 3.0 | <ol style="list-style-type: none"> Ensure that the host computer supports USB 3.0, refer to manual for the computer to confirm. Ensure the LEX unit is connected to a USB 3.0 port. The centre of the port should be blue. Another colour, such as black usually indicates a USB 2.0 Ensure that a multimode fiber optic cable with crossover is connected between the LEX and REX units. Connect a fiber optic crossover patch cord between the LEX and REX units. Recheck operation of the system. |
| Status LED is off on one or both units | <ul style="list-style-type: none"> The computer went into suspend, hibernate or sleep mode. The computer tried to suspend the USB 3.0 port that the LEX is connected to. | <ol style="list-style-type: none"> Power cycle the REX unit and the devices connected to the REX Power cycle the LEX and REX units, and the devices connected to the REX Follow the steps in "Preparing Your Computer" on page 7 to disable suspend modes on your computer. Refer to your operating system's manual for additional instructions if necessary. |

| PROBLEM | CAUSE | SOLUTION |
|-----------------------------------------------------------------------------------------------------------------------------------------------------------------|----------------------------------------------------------------------------------------------------------------------------------------------------------------------------------------------------------------------------------------------------------------------|---------------------------------------------------------------------------------------------------------------------------------------------------------------------------------------------------------------------------------------------------------------------------------------------------------------------------------------------------------------------------------------------------------------------------------------------------------------------------------------------------------------------------------------------------------------------------------------------------------------------------------------------------------------------------------------------------------------------------------------------------------------------------------------------------------------------------------------------------------------------------------------------------------------------|
| Host LED on LEX/ REX units are off. | <ul style="list-style-type: none"> • The host computer is not powered on. • The LEX unit is not connected to the computer (when used with the optional LEX AC adapter). • The Spectra 3022 is malfunctioning. | <ol style="list-style-type: none"> 1. Disconnect all USB devices from the REX unit. 2. Disconnect the LEX unit from the computer. 3. Disconnect the REX unit from the AC power adapter. 4. Reconnect the LEX unit to the computer. 5. Reconnect the REX unit to the AC power adapter. 6. In the Universal Serial Bus controllers section of Device Manager, check that the Spectra 3022 is recognized as two "Superspeed Hub"s or two 3.0 Hub"s <p> It may be recognized as "Superspeed Hub", "3.0 Hub" or by other names, depending on the operating system and driver installed.</p> |
| All LEDs on both the LEX unit and REX unit are on but the USB device does not operate correctly, or is detected as an "Unknown Device" in the operating system. | <ul style="list-style-type: none"> • The USB device is malfunctioning. • The computer does not recognize the USB device. • The application software for the device is not operating. • The Spectra 3022 is malfunctioning. | <ol style="list-style-type: none"> 1. Disconnect the Spectra 3022 from the computer. 2. Connect the USB device directly to the USB port on the computer. 3. If the USB device does not operate properly, consult the user documentation for the device. 4. Update your system BIOS, chipset, or USB Host controller drivers from your System/Mother board manufacturer's website. 5. If the USB device operates properly when directly connected to the computer, connect another device (of a different type) to the Spectra 3022. Connect the Spectra 3022 to the computer. 6. If the second USB device does not operate, the Spectra 3022 may be malfunctioning. Contact Technical Support for assistance. 7. If the second USB device does operate properly, the first device may not be compatible with the Spectra 3022. |

Contacting Technical Support

If you are experiencing problems not referenced in the Troubleshooting section, you may contact **Icron Technical Support** at icron.com/support.

Warranty Information

Limited Hardware Warranty

Icron Technologies Corporation warrants that any hardware products accompanying this documentation shall be free from significant defects in material and workmanship for a period of **two years from the date of purchase**. Icron Technologies Corporation's hardware warranty extends to Licensee, its customers, and end users.

The Warranty does not include repair of failures caused by: misuse, neglect, accident, modification, operation outside a normal operating environment, failure caused by service of the device by non-authorized servicers, or failure caused by a product for which Icron Technologies Corporation is not responsible.

Hardware Remedies

Icron Technologies Corporation's entire liability and the Licensee's exclusive remedy for any breach of warranty, shall be, at Icron Technologies Corporation's option, either (a) return of the price paid or (b) repair or replacement of hardware, which will be warranted for the remainder of the original warranty period or 30 days, whichever is longer. These remedies are void if failure of the hardware has resulted from accident, abuse, or misapplication.

Limitation of Liability

The hardware warranty set forth in this agreement replaces all other warranties. Icron Technologies Corporation expressly disclaims all other merchantability and fitness for a particular purpose and noninfringement of third-party rights with respect to the hardware.

Icron Technologies Corporation dealer, agent, or employee is authorized to make any modification extension, or addition to this warranty. Under no circumstances will Icron Technologies Corporation, its suppliers or licensors be liable for any costs of procurement or substitute products or services, lost profits, loss of information or data, or any other special, indirect, consequential, or incidental damages arising in any way out of the sale of, use of, or inability to use Icron Technologies Corporation product or service, even if Icron Technologies Corporation, its suppliers or licensors have been advised of the possibility of such damages. In no case shall Icron Technologies Corporation, its suppliers and licensors' liability exceed the actual money paid for the products at issue.

Since some jurisdictions do not allow the limitation of implied warranties of liability for incidental, consequential, special or indirect damages, the above limitation may not always apply. The above limitation will not apply in case of personal injury where and to the extent that applicable law requires such liability.

Obtaining Warranty Service

To obtain warranty service, you must first contact Icron Technologies Corporation within the warranty period for a Return Material Authorization (RMA) number. Icron Technologies Corporation will not accept returns without an authorized RMA number. Be sure you have the serial numbers of the local extender and remote extender before calling. Package the product appropriately for safe shipment and mark the RMA number on the outside of the package. The package must be sent prepaid to Icron Technologies Corporation. We recommend that you insure it or send it by a method that provides for tracking of the package. The repaired or replaced item will be shipped to you, at Icron Technologies Corporation's expense, not later than thirty days after Icron Technologies Corporation receives the defective product.

Address the returning product to:

RMA Coordinator
Icron Technologies Corporation
4664 Lougheed Highway, Suite 221
Burnaby, BC Canada
V5C 5T5

Contacting Sales

Email: sales@icron.com

Tel: +1 604 638 3920

Contacting Technical Support

icron.com/support

Tel: +1 604 638 3920

Technical Glossary

USB Connectors

USB cables have two classes of connectors. The Type A connectors are used to connect the cable from a USB device to a Type A port on a computer or hub. The Type B connectors are used to attach the USB cable from a USB host to a USB device or hub. There are full-sized, mini, and micro variants of both type A and B connectors.

USB 3.0 introduces changes to the connectors. USB 3.0 and USB 2.0 Type A connectors are the same shape and size and are compatible with each other. However, the USB 3.0 Type B connector will not fit in a USB 2.0 Type B port, though a USB 2.0 Type B connector will fit into a USB 3.0 Type B port.

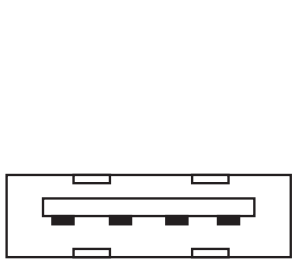

Type A USB 3.0 and 2.0 Port



Type A USB 2.0 Connector

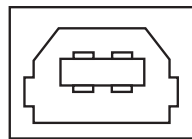

Type B USB 2.0 Port



Type B USB 2.0 Connector

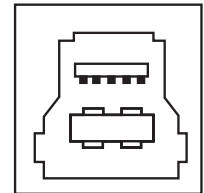

Type B USB 3.0 and 2.0 Port

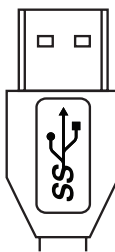

Type A USB 3.0 Connector

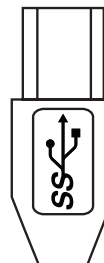

Type B USB 3.0 Connector

Duplex LC Crossover

When a crossover fiber-optic cable is called for, the cable has the transmit signal on one end connected to the receive signal at the other end.

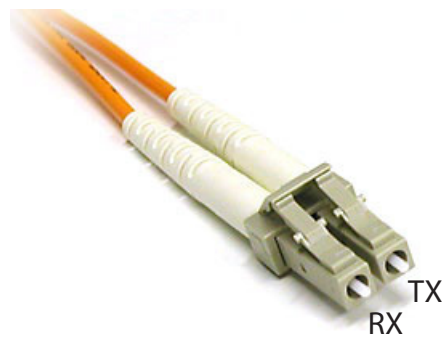

Specifications

| | |
|--------------------------------------|---------------------------------------------------------------|
| Range | Up to 100m (330 ft) |
| USB Device Support & Throughputs | USB 3.0 up to 5Gbps |
| USB Host Support | xHCI controllers (Intel, AMD, Renesas (NEC), Fresco, AsMedia) |
| AC Adapters | 100-240V AC Input, 5V DC Output, Locking |
| Power Available to USB Device at REX | 900mA for each USB Port |
| Enclosure Material | Anodized Aluminum |
| LOCAL EXTENDER (LEX) | |
| USB Connector | 1 x USB 3.0 Type B Locking Receptacle |
| Link Connectors | 1 x Duplex LC Connector |
| Dimensions | 100mm x 76mm x 26mm (3.94" x 2.99" x 1.02") |
| REMOTE EXTENDER (REX) | |
| USB Connectors | 2 x USB 3.0 Type A Locking Receptacles |
| Link Connectors | 1 x Duplex LC Connector |
| Dimensions | 100mm x 76mm x 26mm (3.94" x 2.99" x 1.02") |
| ENVIRONMENTAL | |
| Operating Temperature Range | 0°C to 40°C (32°F to 104°F) |
| Storage Temperature Range | -20°C to 70°C (-4°F to 170°F) |
| Operating Humidity | 20% to 80% relative humidity, non-condensing |
| Storage Humidity | 10% to 90% relative humidity, non-condensing |
| COMPLIANCE | |
| EMC | FCC (Class B), CE (Class B) |
| Machine Vision | AIA USB3 Vision (upon standard release) |
| Environmental | RoHS2 |
| SUPPORT | |
| Warranty | 2 years |



Icron Technologies Corporation
4664 Lougheed Highway, Suite 221
Burnaby, BC Canada
V5C 5T5

Tel: +1 604 638 3920
Fax: +1 604 638 3930
icron.com