

**Data sheet | Item number: 858-514**

Relay module; Nominal input voltage: 24 VAC; 4 changeover contacts;  
Limiting continuous current: 5 A; with gold contacts; with manual operation;  
Red status indicator; Module width: 31 mm

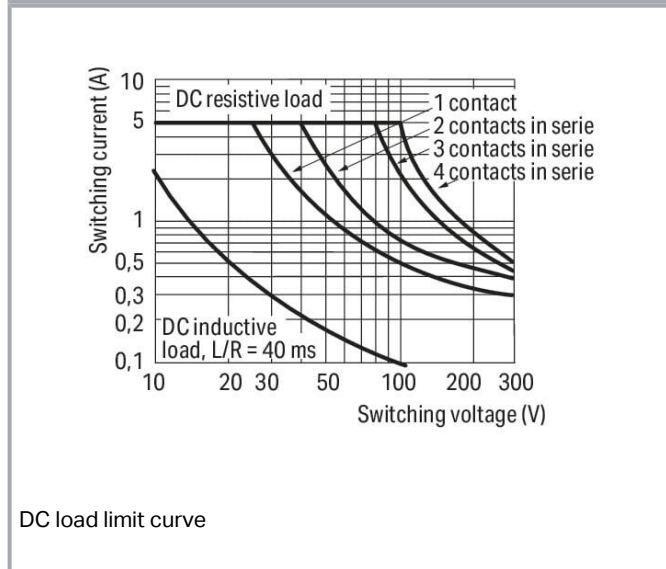

[www.wago.com/858-514](http://www.wago.com/858-514)

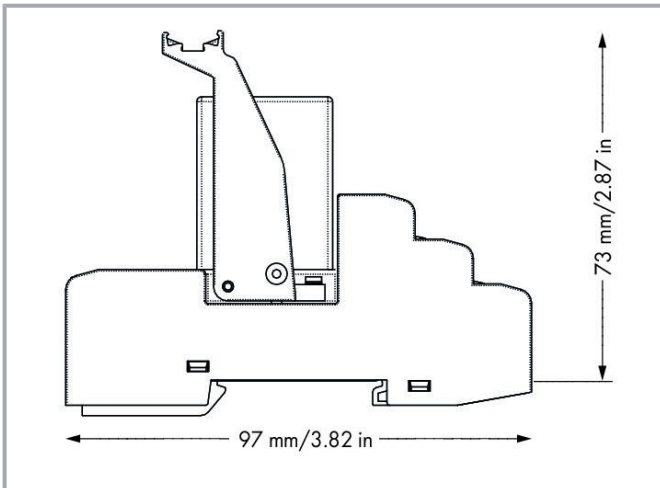
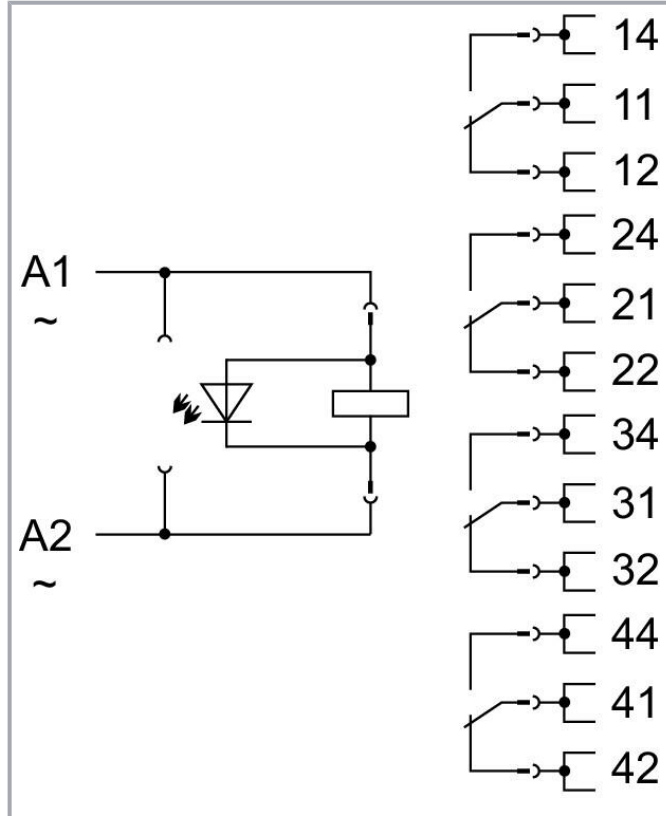
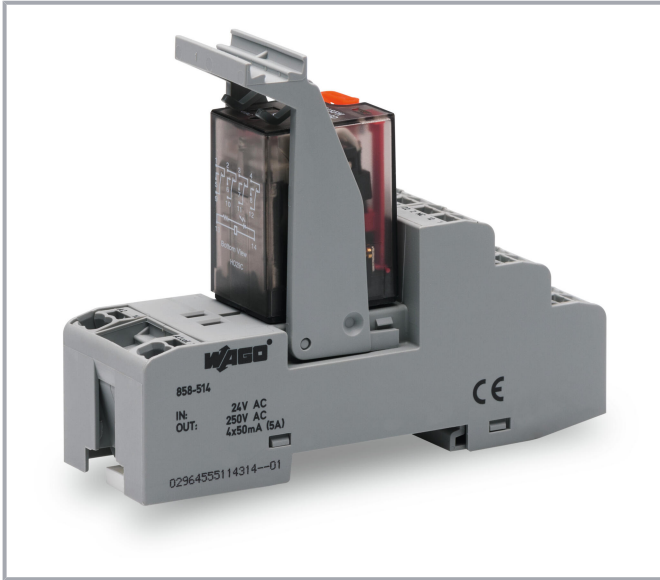

DC load limit curve

Subject to changes. Please also observe the further product documentation!

WAGO GmbH & Co. KG  
Hansastr. 27  
32423 Minden  
Phone: +49571 887-0 | Fax: +49571 887-169  
Email: [info.de@wago.com](mailto:info.de@wago.com) | Web: [www.wago.com](http://www.wago.com)

Do you have any questions about our products?  
We are always happy to take your call at +49 (571) 887-44222.



## Data

### Notes

#### Note

To prevent damaging the gold layer, 30 VDC switching voltages and 50 mA currents must not be exceeded. Higher switching power eventually evaporates the gold layer. The resulting deposits in the housing may reduce service life.

## Technical data

### Control Circuit

Nominal input voltage $U_N$	AC 24 V
Input voltage range	-20 ... +10 %
Nominal input current at $U_N$	50 mA

### Load circuit

Number of changeover/switchover contacts	4
Contact material (relay)	AgCe + Au
Limiting continuous current	5 A
Inrush current (resistive) max.	(AC) 15 A / 4 s
Switching voltage (max.)	AC 250 V
Switching power (resistive) max.	AC 1250 VA; DC (see load limit curve)
Switching capacity	AC-15: 1 A / AC 240 V; DC-13: 2 A / DC 24 V
Recommended minimum load	5 V / 1 mA / 50 mW
Pull-in time (typ.)	25 ms
Drop-out time (typ.)	35 ms
Bounce time (typ.)	4 ms
Electrical life (NO; resistive load; 23 °C)	100 x 10 <sup>3</sup> switching operations
Mechanical life	20 x 10 <sup>6</sup> switching operations

### Signaling

Status indicator	Red LED Mechanical
------------------	-----------------------

Subject to changes. Please also observe the further product documentation!

## Safety and protection

Rated voltage	300 V
Rated surge voltage	2.5 kV
Overvoltage category	II
Pollution degree	2
Dielectric strength (control/load circuit) (AC, 1 min)	1.5 kVrms
Dielectric strength (open contact) (AC, 1 min)	1 kVrms
Dielectric strength (load/load circuit) (AC, 1 min)	1.5 kVrms
Insulation type (control/load circuit)	Basic insulation
Insulation type (open contact)	Functional insulation
Insulation type (load/load circuit)	Basic insulation
Insulation type (adjacent devices)	Reinforced insulation (safe isolation)
Protection type	IP20

## Connection data

Connection technology	Push-in CAGE CLAMP®
Solid conductor	0.34 ... 1.5 mm <sup>2</sup> / 22 ... 16 AWG
Fine-stranded conductor	0.34 ... 1.5 mm <sup>2</sup> / 22 ... 16 AWG
Strip length	9 ... 10 mm / 0.35 ... 0.39 inches
Note (conductor cross-section)	2 x 0.34 ... 2 x 1.5 mm <sup>2</sup> / 1 x 2.5 mm <sup>2</sup> / 2 x 22 ... 2 x 16 AWG

## Physical data

Width	31 mm / 1.22 inches
Height	97 mm / 3.819 inches
Depth from upper-edge of DIN-rail	73 mm / 2.874 inches

## Mechanical data

Mounting type	DIN-35 rail
Mounting position	horizontal (standing/lying); vertical

## Material Data

Fire load	1.255 MJ
Weight	95.5 g

Subject to changes. Please also observe the further product documentation!



## Environmental requirements

Ambient temperature (operation at $U_N$ )	-25 ... +70 °C
Ambient temperature UL (operation at $U_N$ )	-25 ... 50 °C
Ambient temperature (storage)	-40 ... +70 °C
Processing temperature	-25 ... +50 °C
Temperature range of connection cable	$\geq (T_{\text{ambient}} + 25 \text{ K})$
Relative humidity	5 ... 85 %
Operating altitude (max.)	2000 m

## Standards and specifications

Standards/specifications	EN 61010-2-201 EN 61810-1 EN 61373 UL 508 (max. 50 °C)
--------------------------	---

## Commercial data

Product Group	6 (INTERFACE ELECTRONIC)
eCl@ss 10.0	27-37-16-01
eCl@ss 9.0	27-37-16-01
ETIM 8.0	EC001437
ETIM 7.0	EC001437
PU (SPU)	5 pcs
Packaging type	box
Country of origin	DE
GTIN	4055143568180
Customs tariff number	85364900990

## Environmental Product Compliance

RoHS Compliance Status	Compliant, No Exemption
------------------------	-------------------------

## Approvals / Certificates

### General approvals

Logo	Approval	Additional Approval Text	Certificate name
	EAC	TP TC 004/2011	EAC RU C-

Subject to changes. Please also observe the further product documentation!

WAGO GmbH & Co. KG  
Hansastr. 27  
32423 Minden  
Phone: +49571 887-0 | Fax: +49571 887-169  
Email: [info.de@wago.com](mailto:info.de@wago.com) | Web: [www.wago.com](http://www.wago.com)



Do you have any questions about our products?  
We are always happy to take your call at +49 (571) 887-44222.









Brjansker Zertifizierungsstelle

DE.AM02.  
B.00122  
/19

## Declarations of conformity and manufacturer's declarations

Logo	Approval	Additional Approval Text	Certificate name
	EU-Declaration of Conformity WAGO GmbH & Co. KG	-	-
	UK-Declaration of Conformity WAGO GmbH & Co. KG	-	-

## Optional accessories

Ferrule			
	<b>Item no.: 216-241</b> Ferrule; Sleeve for 0.5 mm <sup>2</sup> / 20 AWG; insulated; electro-tin plated; electrolytic copper; gastight crimped; acc. to DIN 46228, Part 4/09.90; white	<a href="http://www.wago.com/216-241">www.wago.com/216-241</a>	
	<b>Item no.: 216-242</b> Ferrule; Sleeve for 0.75 mm <sup>2</sup> / 18 AWG; insulated; electro-tin plated; electrolytic copper; gastight crimped; acc. to DIN 46228, Part 4/09.90; gray	<a href="http://www.wago.com/216-242">www.wago.com/216-242</a>	
	<b>Item no.: 216-243</b> Ferrule; Sleeve for 1 mm <sup>2</sup> / AWG 18; insulated; electro-tin plated; electrolytic copper; gastight crimped; acc. to DIN 46228, Part 4/09.90; red	<a href="http://www.wago.com/216-243">www.wago.com/216-243</a>	
	<b>Item no.: 216-244</b> Ferrule; Sleeve for 1.5 mm <sup>2</sup> / AWG 16; insulated; electro-tin plated; electrolytic copper; gastight crimped; acc. to DIN 46228, Part 4/09.90; black	<a href="http://www.wago.com/216-244">www.wago.com/216-244</a>	
Mounting			
Socket without relay			
	<b>Item no.: 858-110</b> Ejector; for basic relays 25 mm x 35 mm	<a href="http://www.wago.com/858-110">www.wago.com/858-110</a>	
Indicators			
Status indication			
	<b>Item no.: 788-123</b> Accessories for relay modules; Operation status indicator: red; Nominal operating voltage: 24 VAC	<a href="http://www.wago.com/788-123">www.wago.com/788-123</a>	
Basic Relay			

Subject to changes. Please also observe the further product documentation!

## Basic relay

**Item no.: 858-153**

Basic relay; Nominal input voltage: 230 VAC; 4 changeover contacts; Limiting continuous current: 5 A; [www.wago.com/858-153](http://www.wago.com/858-153)  
with gold contacts; with manual operation; Module width: 22 mm; Module height: 25 mm

## Marking accessories

## Marking strip

**Item no.: 2009-110**

Marking strips; for Smart Printer; on reel; not stretchable; plain; snap-on type; white

[www.wago.com/2009-110](http://www.wago.com/2009-110)

## Double marker carrier

**Item no.: 209-128**

Adaptor; gray

[www.wago.com/209-128](http://www.wago.com/209-128)

## Marking devices

**Item no.: 210-110**

Fiber-tip pen

[www.wago.com/210-110](http://www.wago.com/210-110)

## Protective marker cover

**Item no.: 209-184**

Protection cover; transparent

[www.wago.com/209-184](http://www.wago.com/209-184)

## Marker

**Item no.: 2009-115**

WMB-Inline; for Smart Printer; 1500 pieces on roll; stretchable 5 - 5.2 mm; plain; snap-on type; white

[www.wago.com/2009-115](http://www.wago.com/2009-115)

**Item no.: 209-183**

Marker; white

[www.wago.com/209-183](http://www.wago.com/209-183)

**Item no.: 793-501**

WMB marking card; as card; not stretchable; plain; snap-on type; white

[www.wago.com/793-501](http://www.wago.com/793-501)

**Item no.: 793-502**

WMB marking card; as card; MARKED; 1 ... 10 (10x); not stretchable; Horizontal marking; snap-on type; white [www.wago.com/793-502](http://www.wago.com/793-502)

**Item no.: 793-503**

WMB marking card; as card; MARKED; 11 ... 20 (10x); not stretchable; Horizontal marking; snap-on type; white [www.wago.com/793-503](http://www.wago.com/793-503)

**Item no.: 793-504**

WMB marking card; as card; MARKED; 21 ... 30 (10x); not stretchable; Horizontal marking; snap-on type; white [www.wago.com/793-504](http://www.wago.com/793-504)

**Item no.: 793-505**

WMB marking card; as card; MARKED; 31 ... 40 (10x); not stretchable; Horizontal marking; snap-on type; white [www.wago.com/793-505](http://www.wago.com/793-505)

**Item no.: 793-506**

WMB marking card; as card; MARKED; 41 ... 50 (10x); not stretchable; Horizontal marking; snap-on type; white [www.wago.com/793-506](http://www.wago.com/793-506)

Subject to changes. Please also observe the further product documentation!

WAGO GmbH & Co. KG

Hansastr. 27





32423 Minden

Phone: +49571 887-0 | Fax: +49571 887-169

Email: [info.de@wago.com](mailto:info.de@wago.com) | Web: [www.wago.com](http://www.wago.com)

Do you have any questions about our products?

We are always happy to take your call at +49 (571) 887-44222.

	<b>Item no.: 793-566</b> WMB marking card; as card; MARKED; 1 ... 50 (2x); not stretchable; Horizontal marking; snap-on type; white	<a href="http://www.wago.com/793-566">www.wago.com/793-566</a>
	<b>Item no.: 793-5501</b> WMB marking card; as card; for terminal block width 5 - 17.5 mm; stretchable 5 - 5.2 mm; plain; snap-on type; white	<a href="http://www.wago.com/793-5501">www.wago.com/793-5501</a>
Group marker carrier		
	<b>Item no.: 209-145</b> Group marker carrier; white	<a href="http://www.wago.com/209-145">www.wago.com/209-145</a>
	<b>Item no.: 249-105</b> Group marker carrier; gray	<a href="http://www.wago.com/249-105">www.wago.com/249-105</a>
<b>Jumpers</b>		
Jumper		
	<b>Item no.: 858-402</b> Jumper; 2-way; insulated; light blue	<a href="http://www.wago.com/858-402">www.wago.com/858-402</a>
<b>Tool</b>		
Operating tool		
	<b>Item no.: 210-719</b> Operating tool; Blade: 2.5 x 0.4 mm; with a partially insulated shaft	<a href="http://www.wago.com/210-719">www.wago.com/210-719</a>
<b>Filter Module</b>		
Suppressor module		
	<b>Item no.: 788-148</b> Filter module; RC filter element; Nominal voltage: 230 VAC	<a href="http://www.wago.com/788-148">www.wago.com/788-148</a>

## Downloads

### Documentation

#### Bid Text

858-514	2019 Feb 20	docx	Download
docx - Datei		17.8 kB	
858-514	2019 Feb 19	xml	Download
X81 - Datei		5.2 kB	

#### Instruction Leaflet

Stecksocket für Elementarrelais

Subject to changes. Please also observe the further product documentation!

WAGO GmbH & Co. KG  
Hansastr. 27  
32423 Minden  
Phone: +49571 887-0 | Fax: +49571 887-169  
Email: [info.de@wago.com](mailto:info.de@wago.com) | Web: [www.wago.com](http://www.wago.com)

Do you have any questions about our products?  
We are always happy to take your call at +49 (571) 887-44222.



V 2.0.0 2022 Jan 25	pdf 2.2 MB	Download
------------------------	---------------	----------

#### Additional Information

Disposal and Recycling Electrical and electronic equipment, Batteries, Packaging	V 1.1.0 2022 Aug 18	pdf 2.2 MB	Download
---	------------------------	---------------	----------

#### CAD/CAE-Data

##### CAD data

2D/3D Models 858-514	URL	Download
----------------------	-----	----------

##### CAE data

EPLAN Data Portal 858-514	URL	Download
---------------------------	-----	----------

ZUKEN Portal 858-514	URL	Download
----------------------	-----	----------

WSCAD Universe 858-514	URL	Download
------------------------	-----	----------

#### Environmental Product Compliance

##### Compliance Search

Environmental Product Compliance 858-514	URL	Download
--	-----	----------

Relay module; Nominal input voltage: 24 VAC; 4 changeover contacts; Limiting continuous current: 5 A; with gold contacts; with manual operation; Red status indicator; Module width: 31 mm

#### Installation Notes

##### Commoning

Subject to changes. Please also observe the further product documentation!



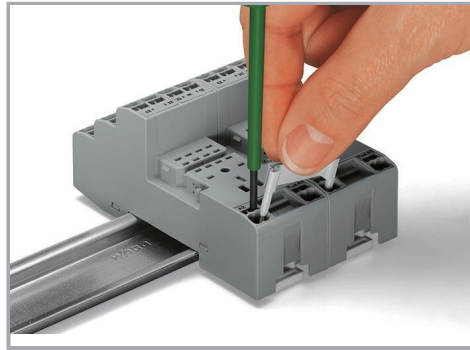
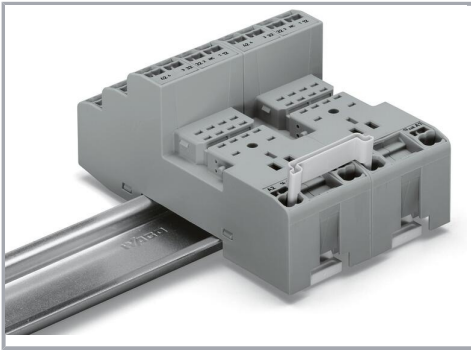

Removing a jumper via screwdriver.

### Marking

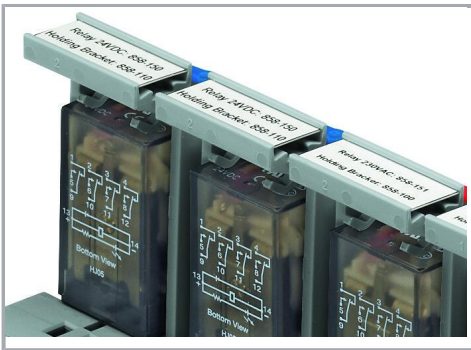

Marking using WMB Multi markers and group marker carriers.

Subject to changes. Please also observe the further product documentation!