

Item description

Female connector/socket *WINSTA*® MIDI with protection type IP20

The *WINSTA*® MIDI female connector/socket rated current 25 A is the pluggable solution for your application in control cabinets, for lighting connections or on PCBs. WAGO pluggable installation connectors are used when criteria repeat or are distributed on a specific grid, for example for installing grid lighting or flush-mount lighting. The color coding and mechanical coding of the pluggable installation connector ensure error-free installation of the individual components – including protection against mismatching. The pluggable installation connector offers protection against contact with live components in accordance with protection type IP20 (When mated and secured with a strain relief housing: IP2xC (These compact connectors are not designed for use in open, easily accessible areas!)). Solutions like the *WINSTA*® MIDI pluggable installation connectors with B coding are suitable for process control, for example, for lighting or within data networks. The rated current and voltage are important criteria for selecting a pluggable installation connector: They provide information about possible domains of use and applications. This product has a current rating of 25 A – therefore it is also suitable for robust loads. Our *WINSTA*® MIDI product line allows maximum flexibility for the electrical installation. Through its Push-in CAGE CLAMP® spring pressure connection technology, it ensures time-saving, error-free installation and offers flexibility for meeting an enormous variety of installation requirements.

Subject to changes. Please also observe the further product documentation!



Lower costs through fast commissioning and elimination of service expenses – solutions from WINSTA® MIDI

The WINSTA® Pluggable Connection System allows pluggable electrical installation. This significantly reduces the need for servicing and lowers costs. Enjoy the benefits of the pluggable version of our maintenance-free spring pressure connection technology too! Plan your installation with WINSTA® MIDI pluggable installation connectors with marking from WAGO.

- pluggable installation connectors with protection against mismatching
- simple circuits
- with B coding for use in automation of processes, such as lighting technology, for example
- exact dimensions
- quick replacement of defective units during ongoing operation

Data

Notes

Variants:

Other pole markings

Other versions (or variants) can be requested from WAGO Sales or configured at <https://configurator.wago.com/>.

Electrical data

Ratings per IEC/EN

| Ratings per | IEC/EN 60664-1 |
|-------------------------------|---|
| Nominal voltage (III/3) | 250 V |
| Rated impulse voltage (III/3) | 4 kV |
| Rated current | 25 A |
| Legend (ratings) | (III / 3) ≙ Overvoltage category III / Pollution degree 3 |

Ratings per UL 1977

| | |
|-------------------------|--|
| Note for the US market | Some versions may also be used for current interruption in accordance with the UL certificate in select applications with currents below 16 A and voltages up to 600 V. For further information, please contact your local sales office. |
| Rated voltage (UL 1977) | 600 V |
| Rated current UL 1977 | 23 A |

Subject to changes. Please also observe the further product documentation!



General

| | |
|----------------------------|--|
| Note on contact resistance | approx. 1 mΩ of contact resistance approx. 0.25 mΩ contact transition plug/socket |
|----------------------------|--|

Connection data

| | |
|----------------------------|---|
| Connection points | 4 |
| Total number of potentials | 2 |

Connection 1

| | |
|--|--|
| Connection technology | Push-in CAGE CLAMP® |
| Actuation type | Operating tool Push-in |
| Nominal cross-section | 4 mm ² / 12 AWG |
| Solid conductor | 0.5 ... 4 mm ² / 20 ... 12 AWG |
| Solid conductor; push-in termination | 1.5 ... 4 mm ² / 16 ... 12 AWG |
| Stranded conductor | 0.5 ... 2.5 mm ² / 20 ... 14 AWG |
| Fine-stranded conductor | 0.5 ... 4 mm ² / 20 ... 12 AWG |
| Fine-stranded conductor; with insulated ferrule | 0.25 ... 1.5 mm ² / 20 ... 16 AWG |
| Fine-stranded conductor; with uninsulated ferrule | 0.25 ... 2.5 mm ² / 20 ... 14 AWG |
| Fine-stranded conductor; with ferrule; push-in termination | 1.5 mm ² / 16 AWG |
| Strip length | 9 mm / 0.35 inches |
| Pole number | 2 |
| Conductor entry direction to mating direction | 0° |

Physical data

| | |
|-------------|------------------------|
| Pin spacing | 10 mm / 0.394 inches |
| Width | 20 mm / 0.787 inches |
| Height | 12.9 mm / 0.508 inches |
| Depth | 37.5 mm / 1.476 inches |

Mechanical Data

| | |
|-------------------|--------------------|
| Application | Control technology |
| Coding | B |
| Variable coding | No |
| Marking | 1 2 |
| Potential marking | 1 2 |

Subject to changes. Please also observe the further product documentation!



| | |
|---|---|
| Mating force of a plug-in connection | approx. 20 ... 70 N (depending on pole number) |
| Retention force of a plug-in connection | Locked: > 80 N |
| Unmating force of a plug-in connection | Unlocked: approx. 20 ... 70 N (depending on pole number) |
| Number of mating cycles | 200, without resistive load |
| Protection type | IP20; When mated and secured with a strain relief housing: IP2xC (These compact connectors are not designed for use in open, easily accessible areas!) |

Plug-in connection

| | |
|------------------------------------|--|
| Contact type (pluggable connector) | Female connector/socket |
| Connector (connection type) | for conductor |
| Mismating protection | Yes |
| Note on mismating protection | All <i>WINSTA</i> [®] components are 100% protected against mismating when: a.) plugging different numbers of poles b.) plugging while rotated 180 c.) plugging while laterally staggered d.) plugging one pole |
| Locking lever | Can be retrofitted |
| Locking of plug-in connection | locking lever |
| Note on locking system | All connectors for mounted installations (snap-in versions for lighting fixtures or devices, all types of PCB and distribution connectors) are factory-equipped with locking levers to ensure plugs and sockets are securely locked. Additional locking levers are only required for flying leads (plug/socket). |

Material Data

| | |
|-----------------------------|--|
| Note (material data) | Information on material specifications can be found here |
| Color | light green |
| Cover color | gray |
| Material group | I |
| Insulation material | Polyamide (PA66) |
| Flammability class per UL94 | V0 |
| Clamping spring material | Chrome-nickel spring steel (CrNi) |
| Contact material | Copper or copper alloy; surface-treated |
| Contact plating | Tin |
| Fire load | 0.127 MJ |
| Weight | 6.6 g |

Subject to changes. Please also observe the further product documentation!

Environmental requirements

| | |
|--|--|
| Processing temperature | -5 ... +40 °C |
| Continuous operating temperature | -35 ... +85 °C |
| Note on continuous operating temperature | Insulating parts for temperatures ≤ 105 °C |

Commercial data



| | |
|-----------------------|---------------|
| Product Group | 20 (Winsta) |
| eCl@ss 10.0 | 27-44-06-05 |
| eCl@ss 9.0 | 27-44-06-05 |
| ETIM 8.0 | EC002560 |
| ETIM 7.0 | EC002560 |
| PU (SPU) | 100 pcs |
| Packaging type | box |
| Country of origin | DE |
| GTIN | 4050821541882 |
| Customs tariff number | 85366990990 |

Environmental Product Compliance

| | |
|------------------------|-------------------------|
| RoHS Compliance Status | Compliant, No Exemption |
|------------------------|-------------------------|

Approvals / Certificates

General approvals

| Logo | Approval | Additional Approval Text | Certificate name |
|--|---|--------------------------|------------------|
| | CCA DEKRA Certification B.V. | IEC 61984 | NL-32104 |
|  | CCA DEKRA Certification B.V. | EN 61984 | 2173495.01 |
|  | cURus Underwriters Laboratories Inc. | UL 1977 | E45171 |

Declarations of conformity and manufacturer's declarations

| Logo | Approval | Additional Approval Text | Certificate name |
|------|----------|--------------------------|------------------|
|------|----------|--------------------------|------------------|

Subject to changes. Please also observe the further product documentation!



EU-Declaration of Conformity
WAGO GmbH & Co. KG

-

-





UK-Declaration of Conformity
WAGO GmbH & Co. KG





-

-





Approvals for marine applications

| Logo | Approval | Additional Approval Text | Certificate name |
|--|---|--------------------------|--------------------------|
|  | ABS American Bureau of Shipping | - | 19- HG1868589- PDA |
|  | DNV GL Det Norske Veritas, Germanischer Lloyd | - | TAE00001Z6 |
|  | LR Lloyds Register | IEC 61984 | LR22429487TA |

Counterpart

| | | |
|--|---|--|
|  | Item no.770-1602 T-distribution connector; 2-pole; Cod. B; 1 input; 2 outputs; 2 locking levers; light green | www.wago.com/770-1602 |
|  | Item no.770-1609 h-distribution connector; 2-pole; Cod. B; 1 input; 2 outputs; outputs on both sides; 2 locking levers; light green | www.wago.com/770-1609 |
|  | Item no.770-1652 h-distribution connector; 2-pole; Cod. B; 1 input; 2 outputs; outputs on one side; 2 locking levers; light green | www.wago.com/770-1652 |
|  | Item no.770-1659 h-distribution connector; 2-pole; Cod. B; 1 input; 2 outputs; outputs on both sides; 3 locking levers; for flying leads; light green | www.wago.com/770-1659 |
|  | Item no.770-1702 T-distribution connector; 2-pole; Cod. B; 1 input; 2 outputs; 3 locking levers; for flying leads; light green | www.wago.com/770-1702 |





Subject to changes. Please also observe the further product documentation!

| | | |
|--|--|--|
|  | Item no. 770-1705 3-way distribution connector; 2-pole; Cod. B; 1 input; 3 outputs; light green | www.wago.com/770-1705 |
|  | Item no. 770-272 Plug; 2-pole; Cod. B; 4,00 mm ² ; light green | www.wago.com/770-272 |
|  | Item no. 770-1752 h-distribution connector; 2-pole; Cod. B; 1 input; 2 outputs; outputs on one side; 3 locking levers; for flying leads; light green | www.wago.com/770-1752 |
|  | Item no. 771-8992/005-105 pre-assembled interconnecting cable; Eca; Socket/plug; 2-pole; Cod. B; Control cable 2 x 1.0 mm ² ; 1 m; 1,00 mm ² ; light green | www.wago.com/771-8992/005-105 |
|  | Item no. 771-8992/205-105 pre-assembled connecting cable; Eca; Plug/open-ended; 2-pole; Cod. B; Control cable 2 x 1.0 mm ² ; 1 m; 1,00 mm ² ; light green | www.wago.com/771-8992/205-105 |

Required accessories



Locking levers

Locking system

| | | |
|--|--|--|
|  | Item no.: 770-121 Locking lever; for flying leads; for manual operation; white | www.wago.com/770-121 |
|  | Item no.: 770-131 Locking lever; for flying leads; for tool operation; white | www.wago.com/770-131 |
|  | Item no.: 770-101 Locking lever; for flying leads; for manual operation; black | www.wago.com/770-101 |
|  | Item no.: 770-111 Locking lever; for flying leads; for tool operation; black | www.wago.com/770-111 |

Strain relief

Strain relief housing

| | | |
|--|--|--|
|  | Item no.: 770-502/041-000 Strain relief housing; 2-pole; with locking clip; for 1 cable; 7.0 ... 10.5 mm; 35 mm; black | www.wago.com/770-502/041-000 |
|  | Item no.: 770-502/042-000 Strain relief housing; 2-pole; with locking clip; for 1 cable; 5.0 ... 9.0 mm; 35 mm; black | www.wago.com/770-502/042-000 |

Subject to changes. Please also observe the further product documentation!



Item no.: 770-512/041-000

Strain relief housing; 2-pole; with locking clip; for 1 cable; 7.0 ... 10.5 mm; 35 mm; white

www.wago.com/770-512/041-000



Item no.: 770-512/042-000

Strain relief housing; 2-pole; with locking clip; for 1 cable; 5.0 ... 9.0 mm; 35 mm; white

www.wago.com/770-512/042-000

Optional accessories

Mounting

Snap-in frame



Item no.: 770-317

Snap-in frame; 2-pole; 1.0 ... 3.0 mm; black

www.wago.com/770-317



Item no.: 770-337

Snap-in frame; 2-pole; 1.0 ... 3.0 mm; black

www.wago.com/770-337

Mounting accessories



Item no.: 897-2100

Mounting plate; for Snap-in; Plastic; for detectors and sensors ; Ø 200 mm; red

www.wago.com/897-2100

Cover

Cover



Item no.: 770-201

Lockout cap; 12-pole, separable; for sockets; Plastic; black

www.wago.com/770-201



Item no.: 770-221

Lockout cap; 12-pole, separable; for sockets; Plastic; white

www.wago.com/770-221



Item no.: 897-2003

Protective cap; Type2; for sockets and plugs; PVC; red

www.wago.com/897-2003

Tool

Operating tool



Item no.: 210-719

Operating tool; Blade: 2.5 x 0.4 mm; with a partially insulated shaft

www.wago.com/210-719

Subject to changes. Please also observe the further product documentation!

WAGO GmbH & Co. KG

Hansastr. 27

32423 Minden

Phone: +49571 887-0 | Fax: +49571 887-169

Email: info.de@wago.com | Web: www.wago.com

Do you have any questions about our products?

We are always happy to take your call at +49 (571) 887-44222.



Item no.: 770-382
Operating tool; 2-way; green

Downloads

Documentation

Bid Text

| | | | |
|------------------------|-------------|----------------|----------|
| 770-262 X81 - Datei | 2019 Feb 19 | xml 3.0 kB | Download |
| 770-262 doc - Datei | 2015 Jun 8 | doc 24.6 kB | Download |

CAD/CAE-Data

CAE data

| | | |
|---------------------------|-----|----------|
| EPLAN Data Portal 770-262 | URL | Download |
| ZUKEN Portal 770-262 | URL | Download |
| WSCAD Universe 770-262 | URL | Download |

CAD data

| | | |
|----------------------|-----|----------|
| 2D/3D Models 770-262 | URL | Download |
|----------------------|-----|----------|

Environmental Product Compliance

Compliance Search

| | | |
|--|-----|----------|
| Environmental Product Compliance 770-262 Socket; 2-pole; Cod. B; 4,00 mm ² ; light green | URL | Download |
|--|-----|----------|

Installation Notes

Conductor termination

Subject to changes. Please also observe the further product documentation!

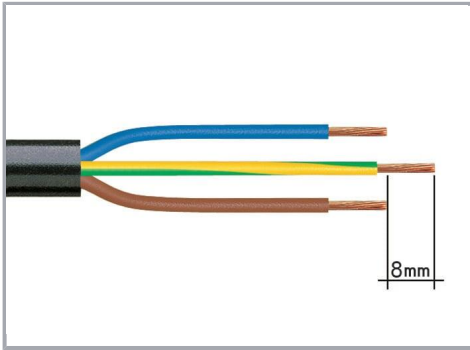

1. Strip length, outer insulation = 35 mm (2-pole), 55 mm (3- to 5-pole)

2. Strip length = 9 mm

3. Extended ground conductor = 8 mm

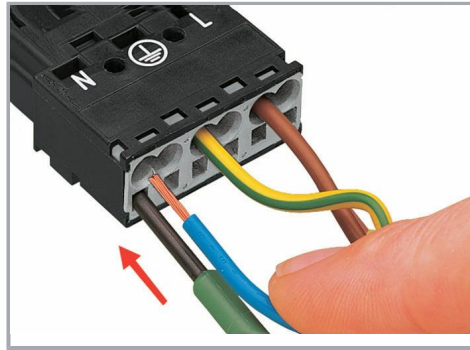

To terminate fine-stranded conductors, open the clamping unit via screwdriver (2.5 mm blade width) and insert a stripped conductor until it hits the backstop.

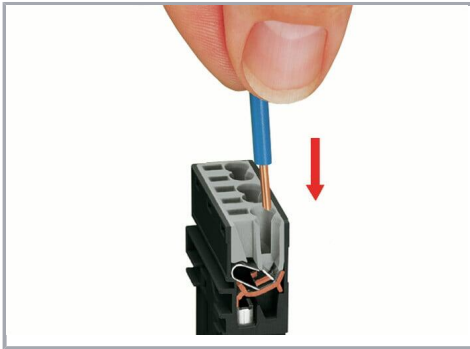

Insert the stripped solid conductor until it hits the backstop.

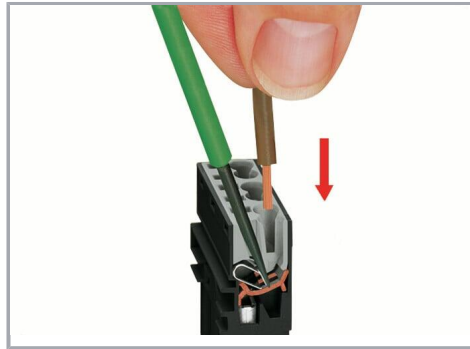

To terminate fine-stranded conductors, open the clamping unit via screwdriver (2.5 mm blade width) and insert a stripped conductor until it hits the backstop.

Conductor removal

Subject to changes. Please also observe the further product documentation!

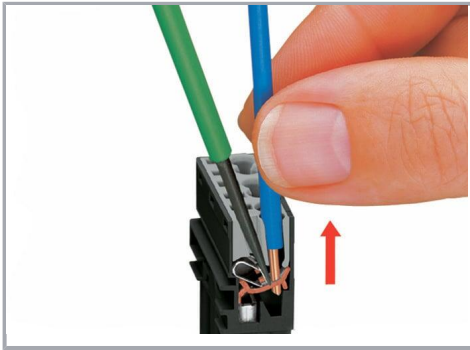

To remove the conductor, actuate the clamp via screwdriver (2.5 mm blade width) and pull out the conductor.

Installation

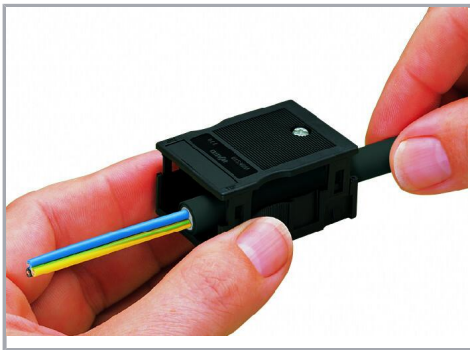

We recommend pulling the pre-latched strain relief housing over the cable prior to termination. However, the strain relief can be mounted at a later time as well.

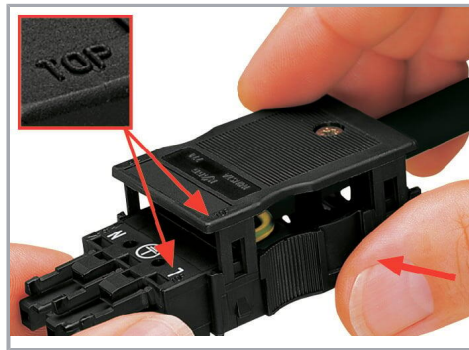

Latch the strain relief housing onto the plug /socket. Note the "TOP" inscription.

Subject to changes. Please also observe the further product documentation!

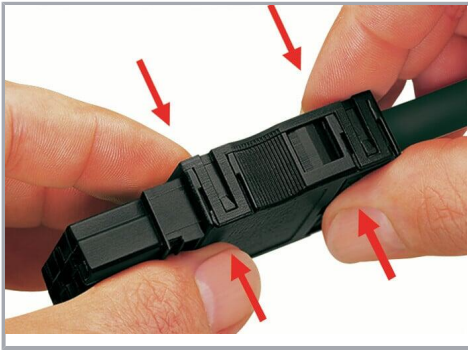

Prepare strain relief housing by snapping together upper and bottom part.



Tighten strain relief screw with screwdriver (2.5 mm blade width).

Coding

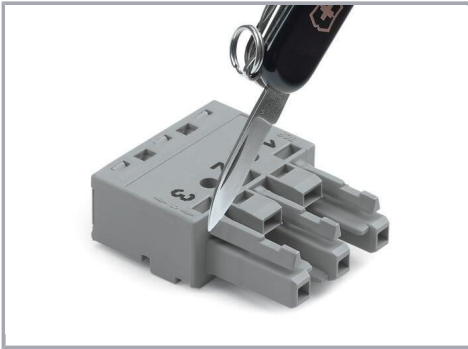

Simply cut off the coding pin from the socket.

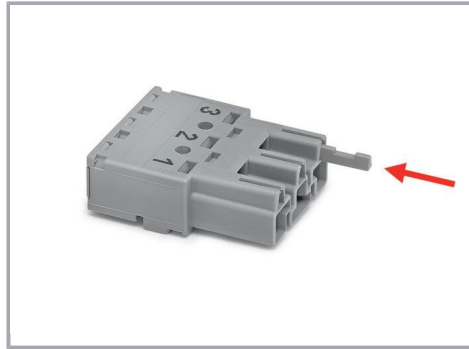

Insert coding pin into plug (break first) until it engages.

Mismatching protection

Subject to changes. Please also observe the further product documentation!

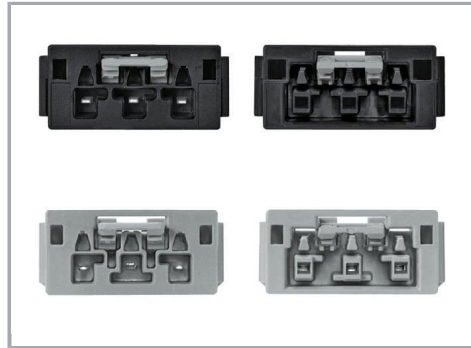
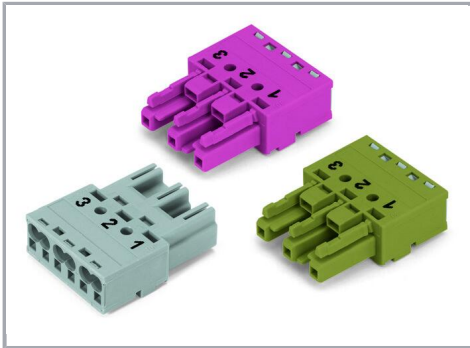

B-coded connectors with different colors can be plugged together.

Important note:

Different colors and/or pole markings are used for circuit identification.

Only connectors of the same color and same pole marking must be plugged together.

B-coded connectors (shown in gray) not only differ in color, but also in their design, making them incompatible with other coded connectors.



Easy circuit identification via different marking and colors

Product family

WINSTA® MIDI

[Show all products from the family](#)

Subject to changes. Please also observe the further product documentation!