

7	8
Rev.	DESCRIPTION

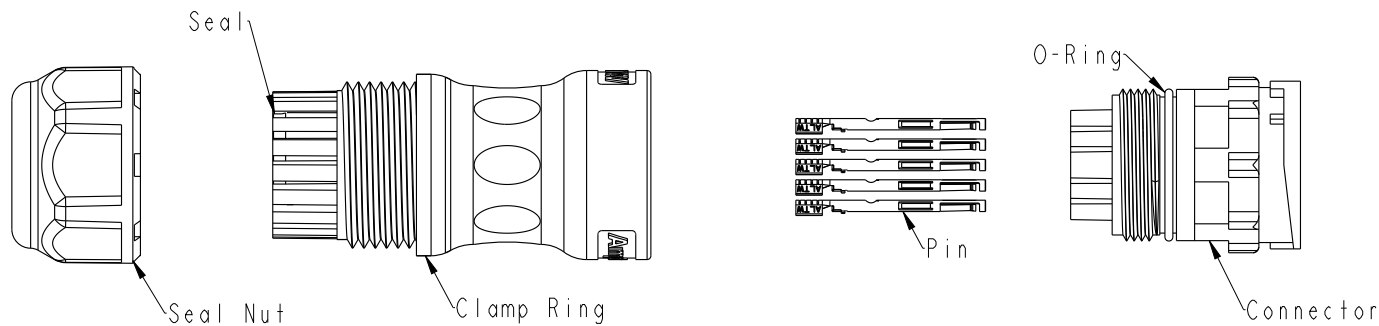

Material Specification:

- \* Connector: Nylon+GF, Black.
- \* Pins: Copper Alloy, Gold Plated.
- \* Seal & O-Ring: Silicone, Gray.
- \* UL Rated: UL 94V-0, fl.
- \* RoHS Compliant.

Electrical Specification:

- \* Contact Resistance: 10mΩ Max.
- \* Insulation Resistance: 100MΩ Min.
- \* Dielectric Withstand Voltage: 1,600 Vac.

Mechanical Specification:

- \* Durability: 1000 Cycles.
- \* Tensile strength: 10 kgf.
- \* Wire Conductor:
  - 5A: 22AWG~20AWG
- \* Wire Insulation OD:
  - 5A: 1.9mm Max.
- \* Torque Force for Clamp Ring: 6~8 kgf-cm
- \* Torque Force for Seal Nut: 6~8 kgf-cm

Environmental Specification:

- \* Waterproof Rating: IP67(Mated)
- \* Temperature Range: -40°C to 105°C.
- \* Salt Spray: Mated, 1000 Hours.
- \* Safety Compliance: UL 1977.

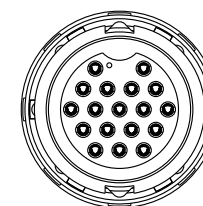
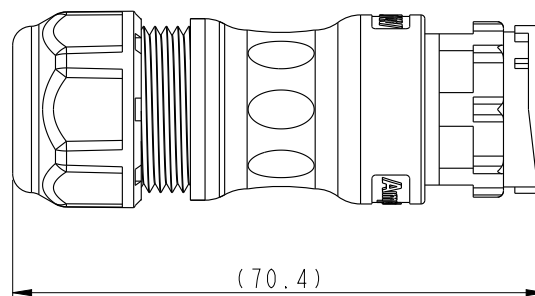
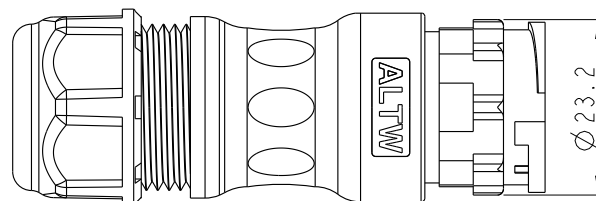

UNIT:mm

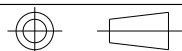

TITLE  
Circular D-Size Field Installable  
Cable Type M Conn

TOLERANCE

±0.5 mm

SCALE 8:5 SIZE A4 SHEET 1 OF 2  
REV. A WC-REV. A.3 QC: Inspection item

**Amphenol LTW**  
安費諾亮泰企業股份有限公司

ITEM NO	DRAWN BY	DATE
DWG NO	CHECKED BY	DATE
CUSTOMER	APPROVED BY	DATE
ALTW	Peng Mafei Jerry	2018-12-15 2018-12-15 2018-12-15

THIS DOCUMENT IS SUBJECT TO CHANGE WITHOUT NOTICE. IT IS CONFIDENTIAL AND A PROPERTY OF Amphenol LTW. DISCLOSURE TO THIRD PARTY HAS TO BE AUTHORIZED BY Amphenol LTW.

THIS DOCUMENT IS SUBJECT TO CHANGE WITHOUT NOTICE. IT IS CONFIDENTIAL AND A PROPERTY OF Amphenol LTW. DISCLOSURE TO THIRD PARTY HAS TO BE AUTHORIZED BY Amphenol LTW.

Ordering Information:

ADD-18BMC-LL7XXX

O: For Data  
P: For Power

P: With Pin  
N: With Out Pin

A: With Red&Yellow&Blue Color Seal  
S: With Red Color Seal, Cable OD 8.0~10.0mm.  
M: With Yellow Color Seal, Cable OD 10.0~12.0mm.  
L: With Blue Color Seal, Cable OD 12.0~14.0mm.

Contacts Gendor  
M: Male Pin  
F: Female Pin

Pin Assignments Front View  
5A ;  
18 Contacts(18)

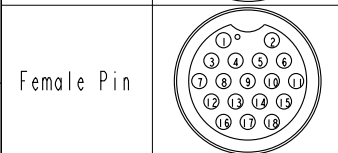
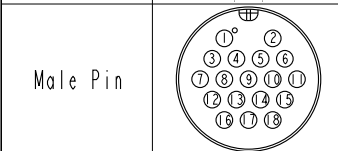

UNIT:mm  
TOLERANCE  
±0.5 mm

TITLE Circular D-Size Field Installable Cable Type M Conn			
SCALE 8:5	SIZE A4	SHEET 2 OF 2	
REV. A	WC-REV. A.3	QC: Inspection item	

**Amphenol LTW**  
安費諾亮泰企業股份有限公司

ITEM NO	DRAWN BY Peng	DATE 2018-12-15
DWG NO ADD-18BMC-LL7XXX	CHECKED BY Mafei	DATE 2018-12-15
CUSTOMER ALTW	APPROVED BY Jerry	DATE 2018-12-15