

Ground Master Monitor Installation, Operation and Maintenance



Made in the
United States of America



Figure 1. SCS 770044 Ground Master Monitor

Description

The SCS Ground Master Monitor is an equipment ground continuous monitor for metal tools. It continuously monitors the path-to-ground impedance and electromagnetic integrity of eight metal ground connections of process tools in work areas. This includes semiconductor, disk drive, flat panel, and electronic equipment manufacturing environments. The monitor provides both visual and audible alarms and includes fuse protection for each channel.

The Ground Master Monitor continuously monitors eight metal tools for electromagnetic interference (EMI). EMI can cause equipment lockups and malfunction. The Ground Master Monitor will alarm if EMI is detected. Each Ground Master Monitor is calibrated with accepted procedures and standards traceable to the National Institute of Standards and Technology (NIST).

The Ground Master Monitor meets the Continuous Monitor requirements of ANSI/ESD S20.20 in accordance with ESD TR53. It meets the recommendations of ESD Handbook ESD TR20.20 which includes “if the products that are being produced are of such value that knowledge of a continuous, reliable ground is needed, and then continuous monitoring should be considered or even required”.

The Ground Master Monitor and its accessories are available as the following item numbers:

Item	Description
770044	Ground Master Monitor
770064	Power Adapter, 100-240 VAC Input, 7.5 VDC 1.5 A Output, All Plugs
770069	Power Relay, North America
CTC065-C	Ground Master Extension Cable Unit
CTE701	Workstation Monitor Checker
770055	SMP Software

Static Management Program

The SCS 770044 Ground Master Monitor is compatible with SCS Static Management Program (SMP). SMP continuously monitors your ESD process control system throughout all stages of manufacturing. SMP captures data from SCS workstation, equipment and ESD event continuous monitors and provides a real-time picture of critical manufacturing processes. All activity is stored into a database for on-going quality control purposes. SMP allows you to pinpoint areas of concern and prevent ESD events. Quantifiable data allows you to see trends, become more proactive and prove the efficiency of your ESD process control system.

SMP is sold separately. [Click here](#) to learn more.

Packaging

- 1 Ground Master Monitor
- 1 Monitor Ground Cord (Green and Yellow)
- 4 Replacement Fuses (250 VAC, 125 mA)
- 1 Ring Terminal
- 1 Screw, Pan-Head, 6-32 x 1/4"
- 1 Star Washer
- 1 Power Adapter, 12 VDC, with interchangeable plugs (North America, UK/Asia, Europe, China)

Features and Components

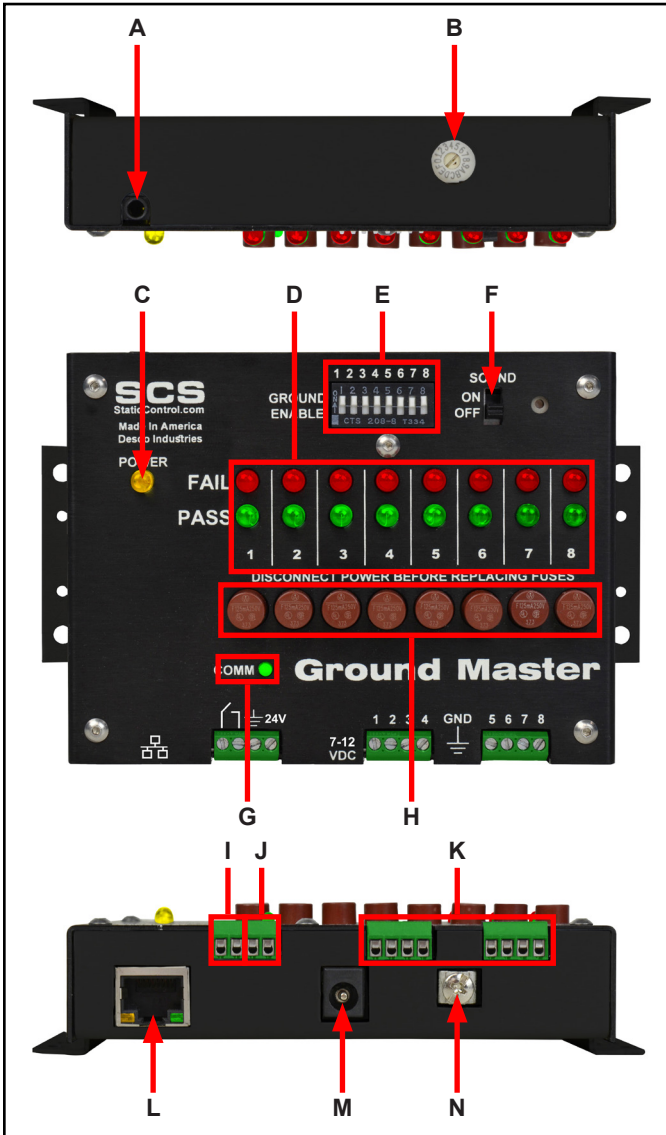

Figure 2. Ground Master Monitor features and components

A. Diagnostics Port: For manufacturer use only.

B. Test Limit Rotary Switch: Sets the test limit of the tool monitor circuits from 1 to 20 ohms.

Setting	Test Limit
1	1 ohm
2	2 ohms
3	3 ohms
4	4 ohms
5	5 ohms
6	6 ohms
7	7 ohms
8	8 ohms
9	9 ohms
A	10 ohms*
B	12 ohms
C	14 ohms
D	16 ohms
E	18 ohms
F	20 ohms

*default setting

C. Power LED: Illuminates yellow when the monitor is powered.

D. Tool LEDs: Illuminates green when its respective tool is within the impedance and electromagnetic interference (EMI) voltage test limits. Blinks red when its respective tool exceeds the EMI voltage limit. Illuminates solid red and audible alarm sounds when its respective tool exceeds the impedance test limit.

E. Tool Monitor Switches: Slide the switch up to enable its respective tool monitor circuit. Slide the switch down to disable its respective tool monitor circuit.

F. Audible Alarm Switch: Enables and disables the monitor's audible alarm.

G. Communication LED: Blinks when the monitor is powered and communicating to SMP Server.

H. Protective Fuses: Protects the spread of harmful voltage to other tools via the Ground Master Monitor should one of the tools become exposed to excessive voltage. The appropriate fuse will disconnect the faulty tool from the Ground Master Monitor and from the other connected tools.

I. Optical Relay Terminals: Integrates with electronic tools, lights, buzzers, etc. The relay opens when the monitor enters a ground alarm condition, and it remains closed otherwise.

Relay Parameter	Rating
Peak Blocking Voltage	400 V _P
Load Current	140 mA _{rms} / mA _{DC}
On-Resistance (max)	22 ohms

J. Power Input Terminals: Accepts 7-24 VDC input from an external source for powering the Ground Master Monitor.

K. Monitored Tool Terminals: Monitors metal tools for proper conductive impedance and electromagnetic interference (EMI) voltage. Use 18 AWG wire to connect the metal tools to these terminals.

L. Ethernet Jack: Provides network communication between the Ground Master Monitor and [Static Management Program \(SMP\)](#).

M. Power Jack: Connect the included power adapter here.

N. Ground Terminal: Common ground point for the monitor.

Installation

Hardware Setup

1. Remove the Ground Master Monitor from the carton, and inspect for damage.
2. Determine the mounting location of the Ground Master Monitor, and use its mounting tabs to secure it. Its display should be visible to the operator(s).
3. Secure one end of the included ground cord to the ground terminal located on the bottom-side of the Ground Master Monitor. Attach the other end of the cord to a ground point. The face plate screw of a grounded AC wall outlet may provide a convenient connection point.
4. Insert stripped terminations of 18 AWG wires (not included) into the monitored tool terminals located on the bottom-side of the Ground Master Monitor. Ensure that the tool monitor switches are enabled if using these monitored tool terminals.
5. Route the tool monitor wires from the bottom-side of the Ground Master Monitor to their respective grounded metal tools, and secure them. Keep the wires as short as possible. Do not loop or coil them as it may affect the measured impedance.

6. Connect an Ethernet cable to the Ethernet jack located on the bottom-side of the Ground Master Monitor. Verify that the cable is properly connected to a network.
7. Connect the power adapter to the power jack located on the bottom-side of the Ground Master Monitor. Route the wire from the supply to a nearby AC outlet and plug it into the outlet. Make sure the voltage and frequency match those listed on the power supply. The Ground Master Monitor is now powered.

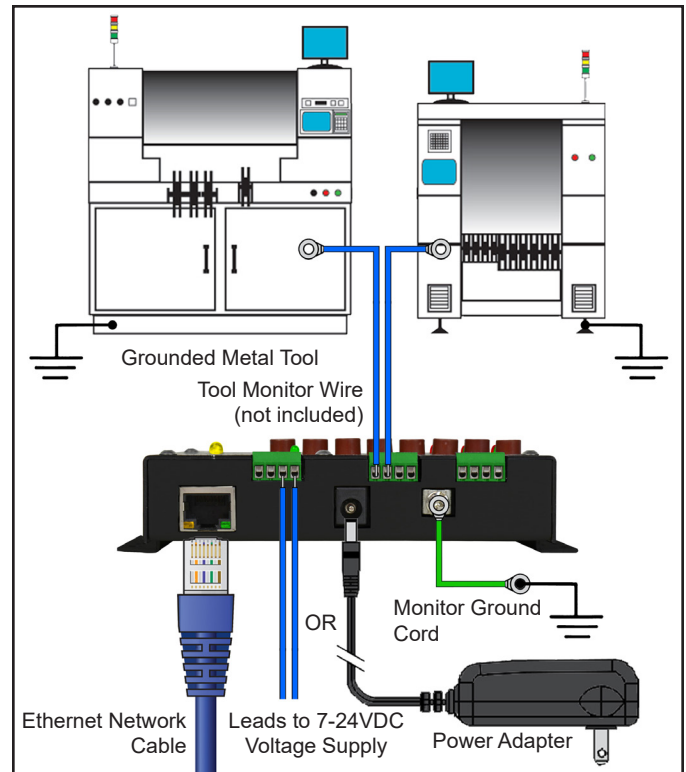

Figure 3. Wiring the Ground Master Monitor to two metal tools

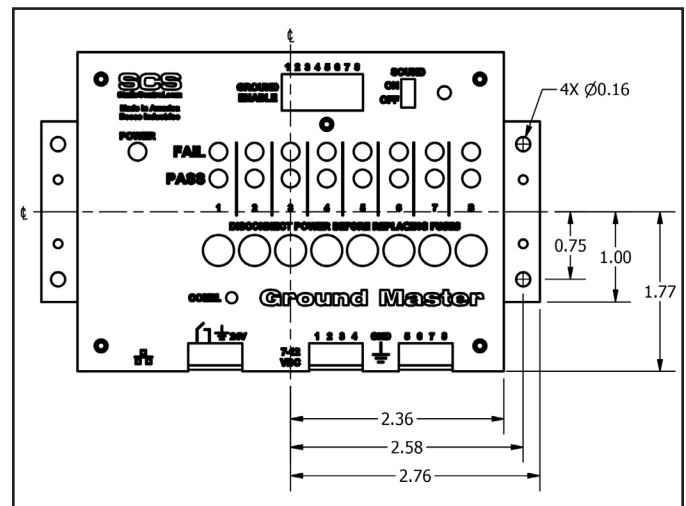

Figure 4. Mounting hole locations (all dimensions are in inches)

SMP Network Setup

The following procedure outlines how to connect the Ground Master Monitor to SMP via a local area network (LAN). SMP must be installed to a PC prior to using this procedure. The diagram shown below illustrates a common SMP system setup that utilizes the server software, client software, WS Aware Monitor, EM Aware Monitor, Ground Master Monitor, and Ion Pro™ Benchtop Ionizer.

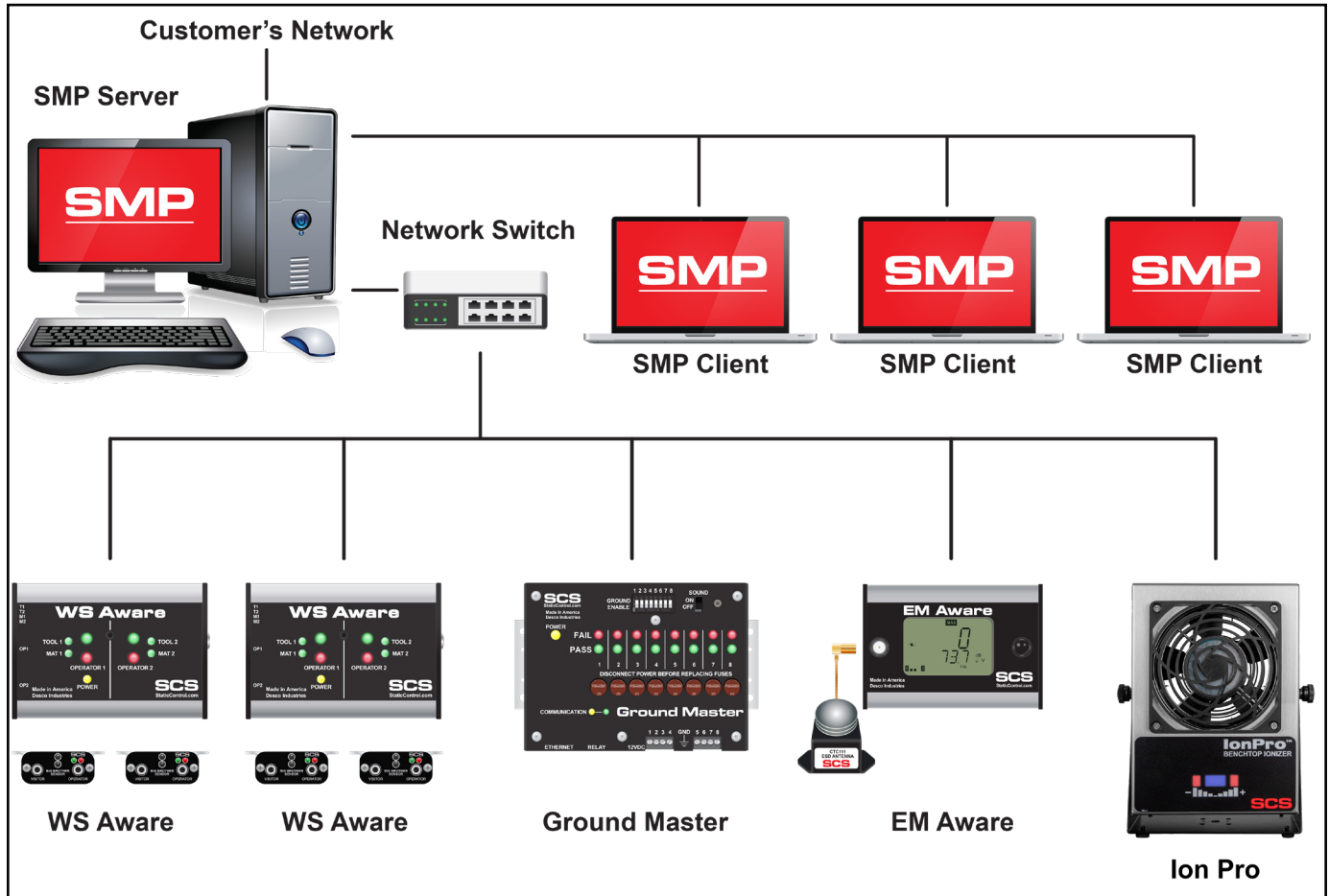
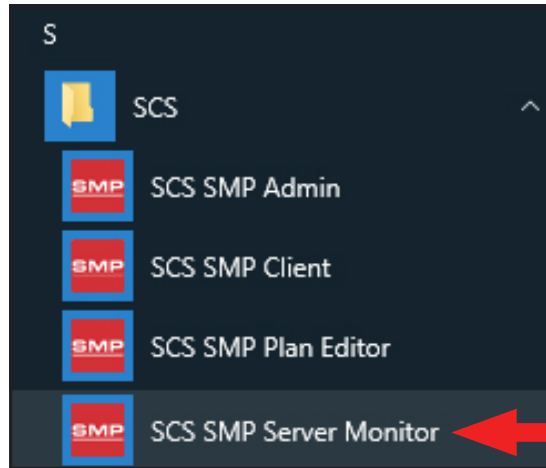

Figure 5. SMP system setup

DYNAMIC IP PROCEDURE

1. Verify that the Ethernet cable is securely connected to your network and Ground Master Monitor. The LEDs on the Ethernet port will illuminate when a connection to the network is established.
2. Open SCS SMP Server Monitor.



3. The SMP Server icon will appear in the Windows taskbar.

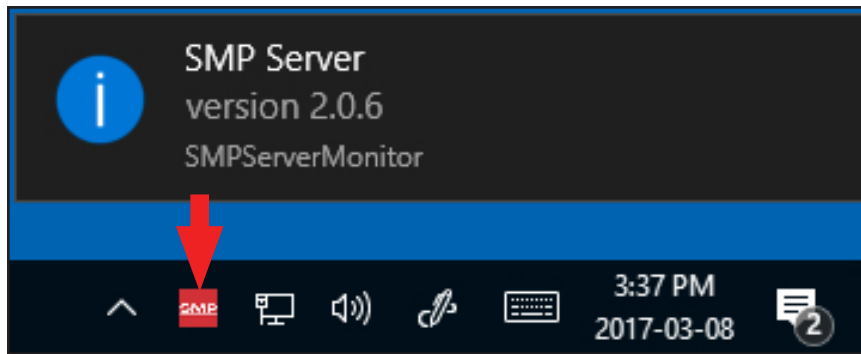

4. Click the SMP Server icon located on the Windows taskbar. The SMP Server menu will appear. Click the Start button to start SMP Server.

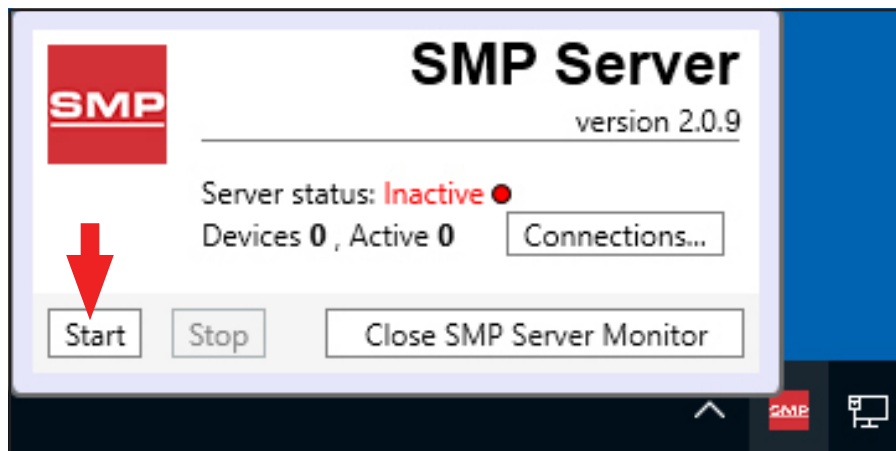

5. A message will appear and display "Starting SMP Server..." Click the SMP Server icon located in the Windows taskbar.

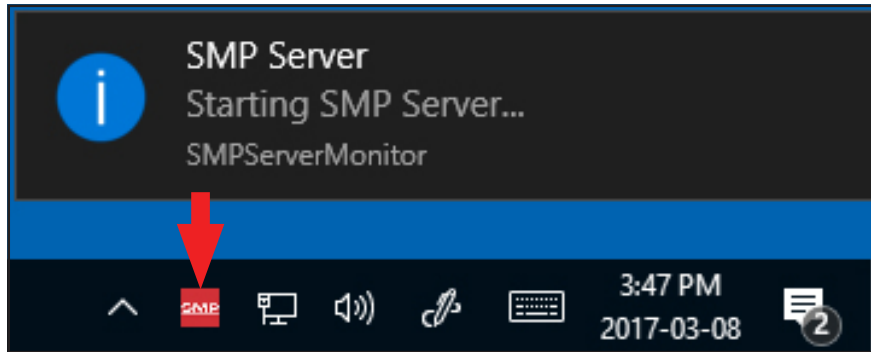

6. SMP Server will now indicate Active server status.

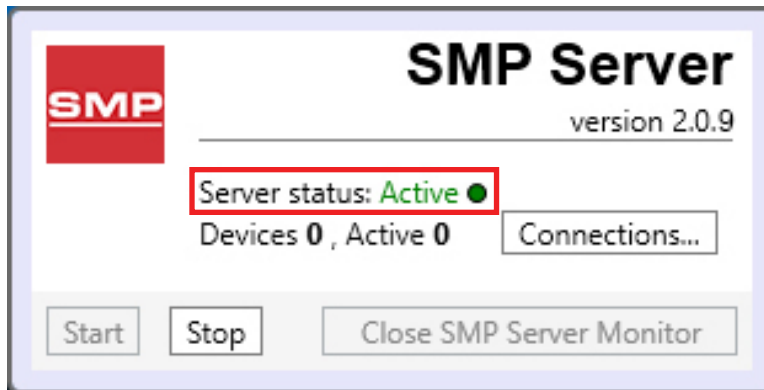

7. SMP Server will search and find the Ground Master Monitor on the network. The Device and Active counts will increase to 1.

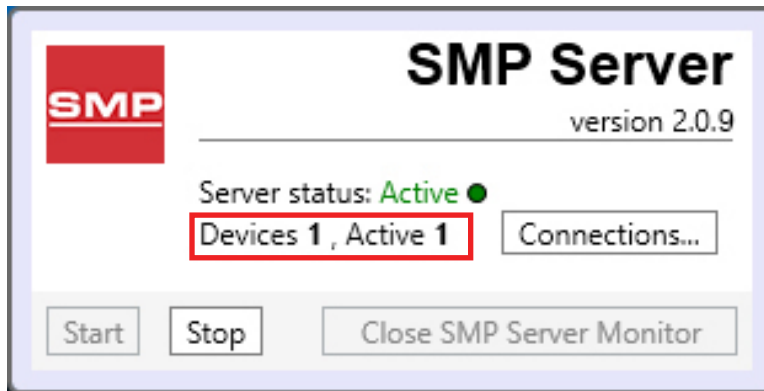

8. Open SCS SMP Admin.

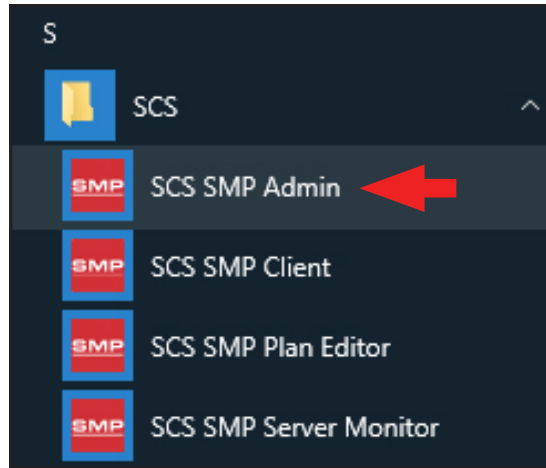

9. The window for SMP Server Admin will appear. "1 unassigned" is representative of the Ground Master Monitor that was just found by SMP Server. Click the Add New Building button.

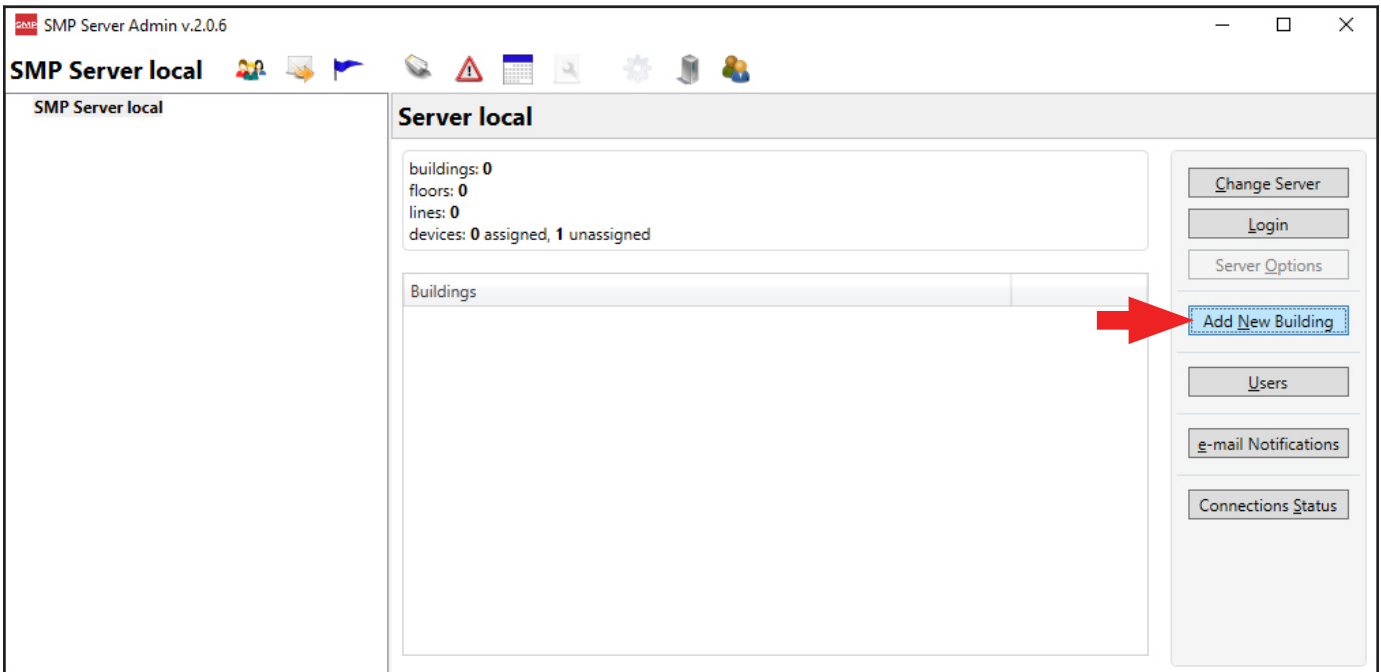

10. Enter a building name, and then click the OK button.

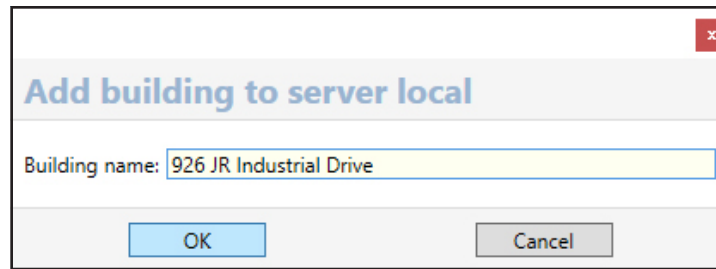

11. The building name will appear on the navigation pane in SMP Server Admin.

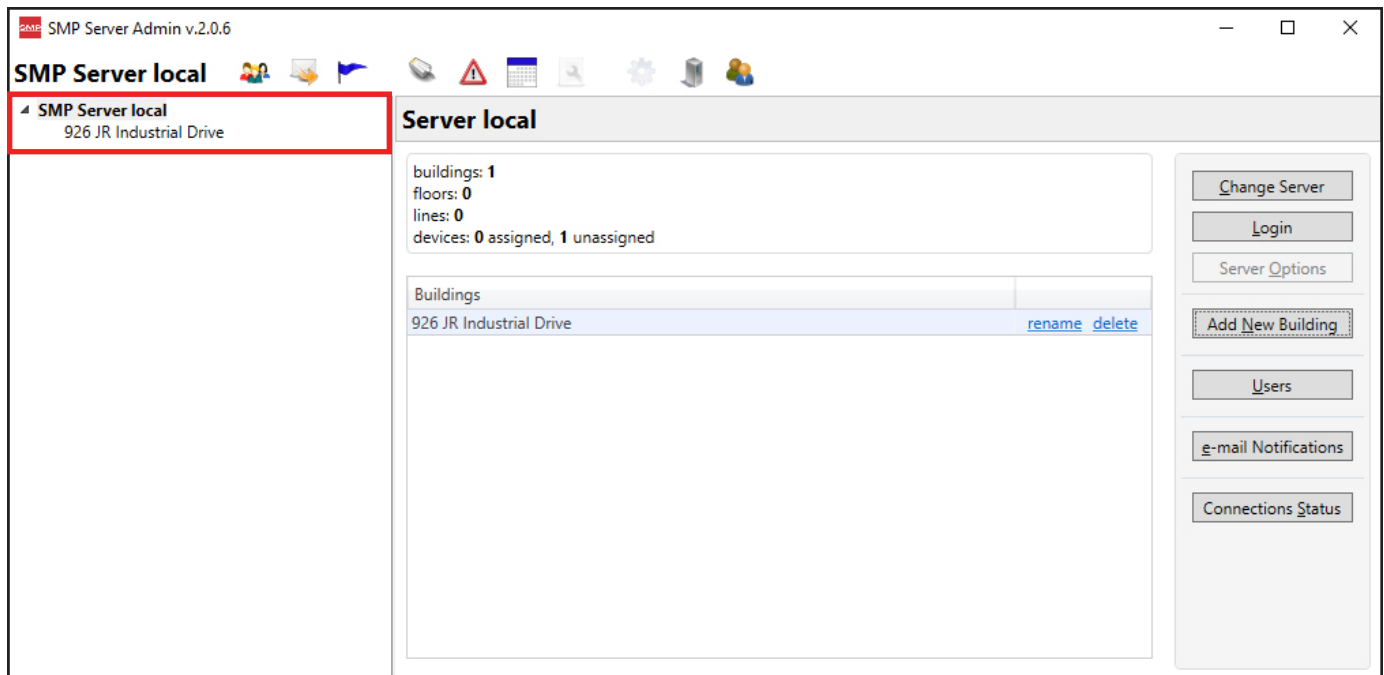

12. Click on the building name in the navigation pane, and then click the Add New Floor button.

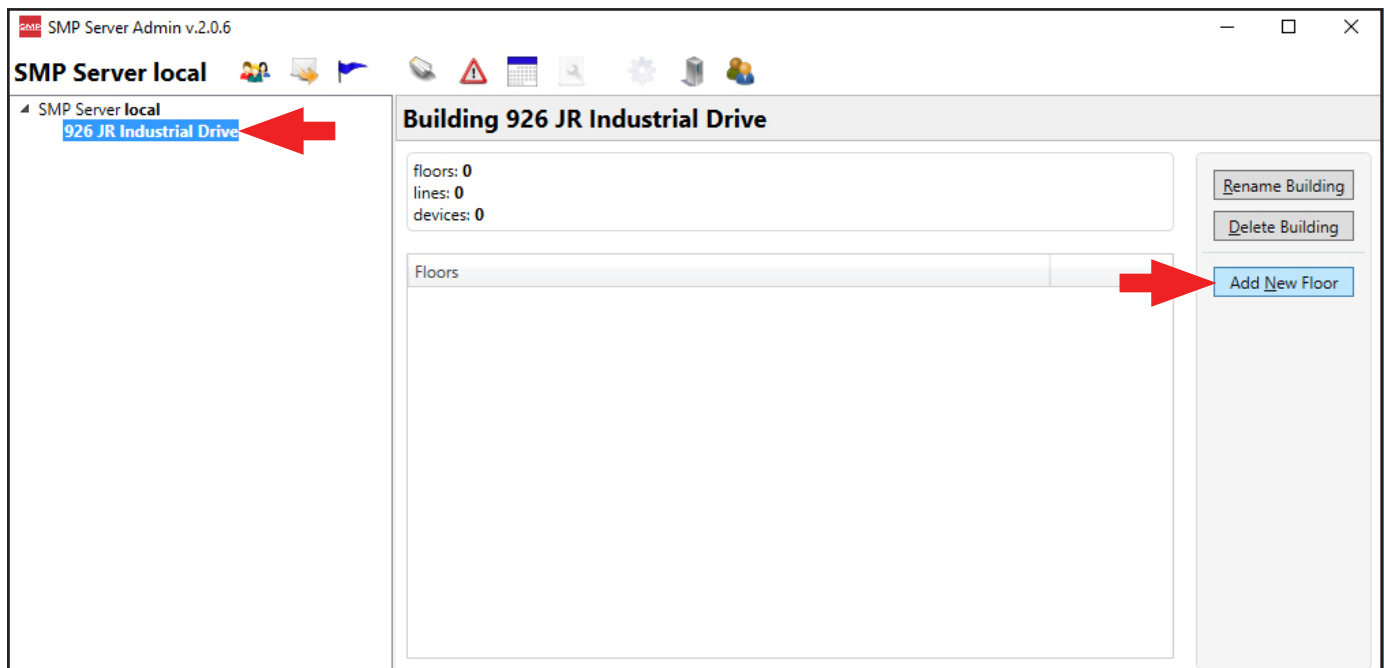

SCS - 926 JR Industrial Drive, Sanford, NC 27332
East: (919) 718-0000 | West: (909) 627-9634 • Website: StaticControl.com

13. Enter a floor name, and then click the OK button.

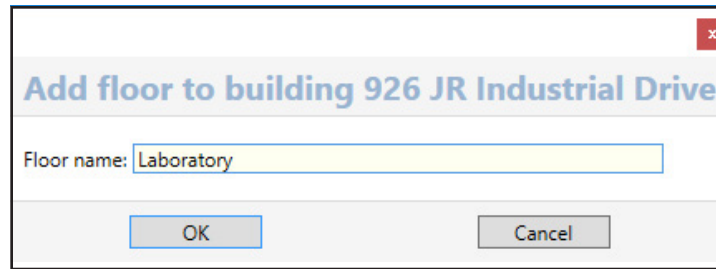

14. The floor name will appear on the navigation pane in SMP Server Admin.

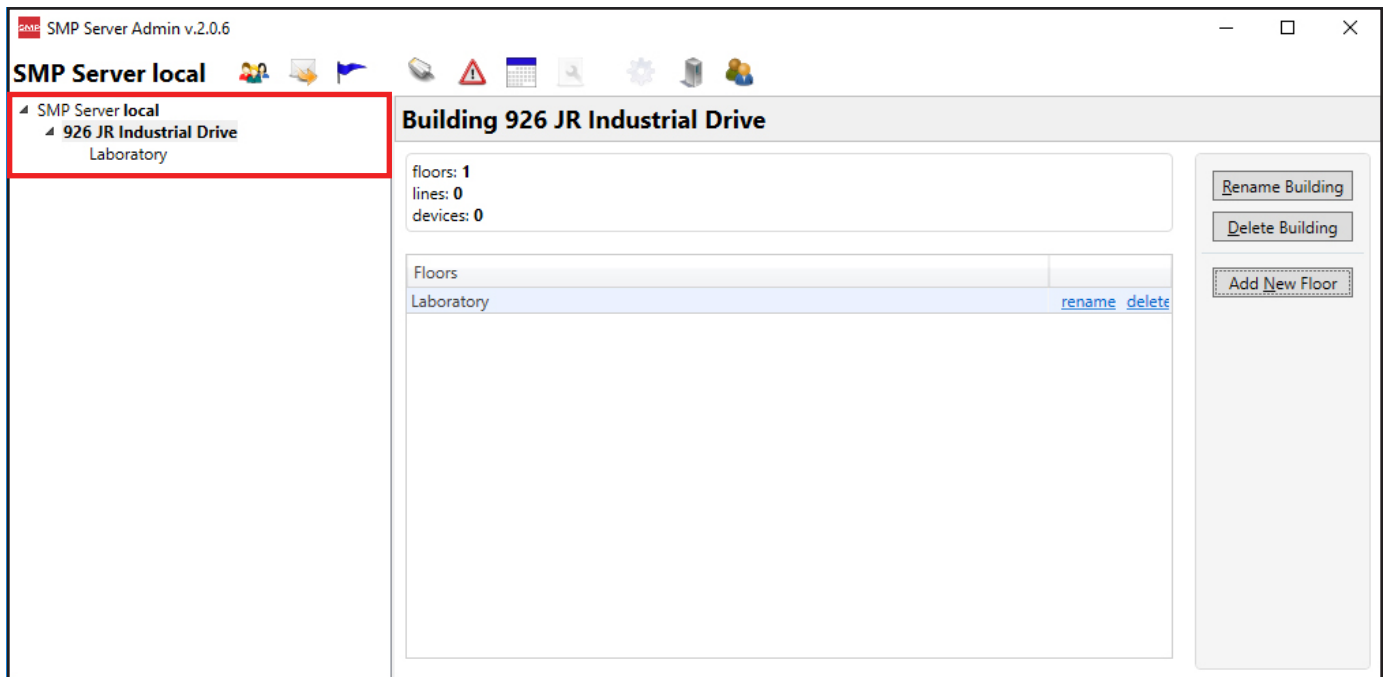

15. Click on the floor name in the navigation pane, and then click the Add New Line button.

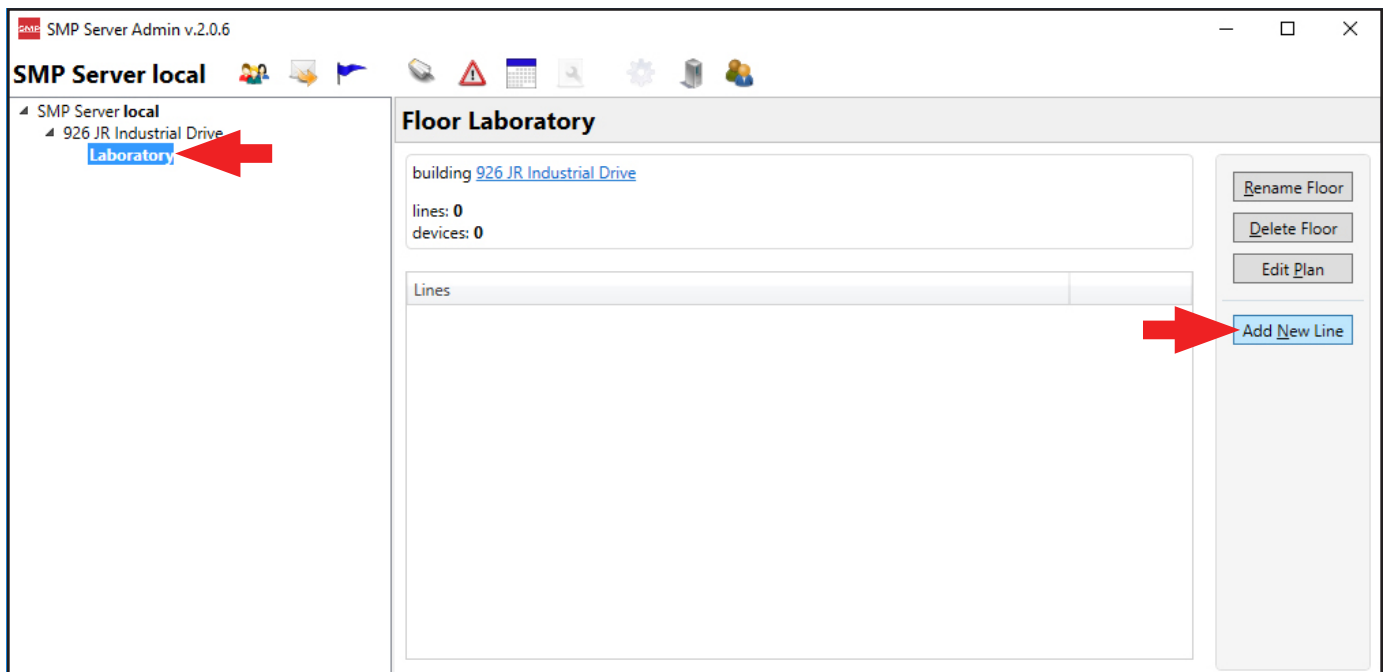

16. Enter a line name, and then click the OK button.

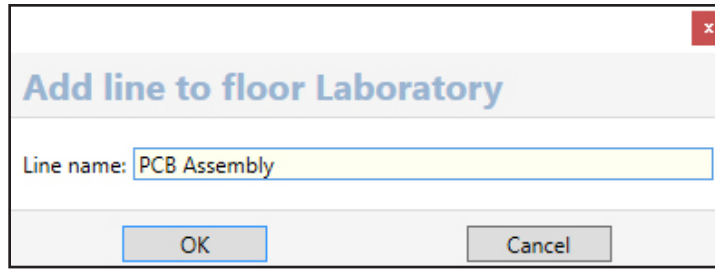

17. The line name will appear on the navigation pane in SMP Server Admin.

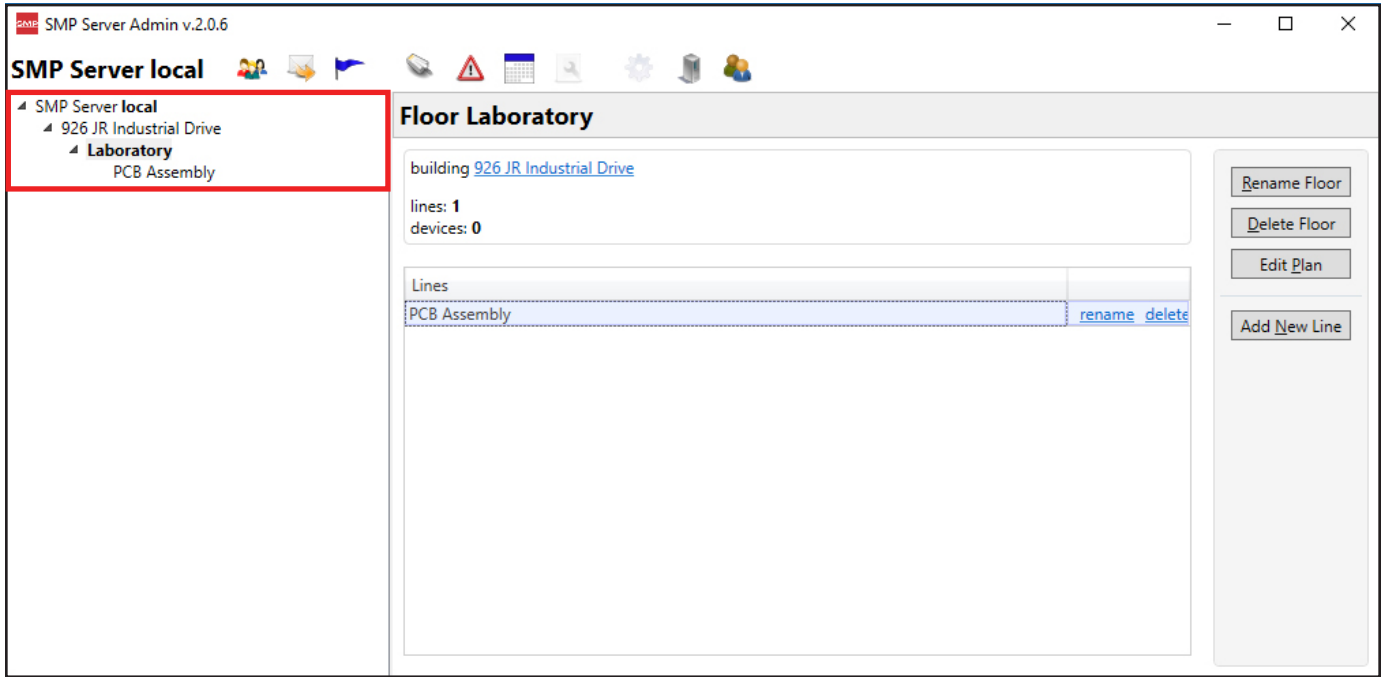

18. Click on the line name in the navigation pane, and then click the Attachable Devices arrow located at the bottom of the window.

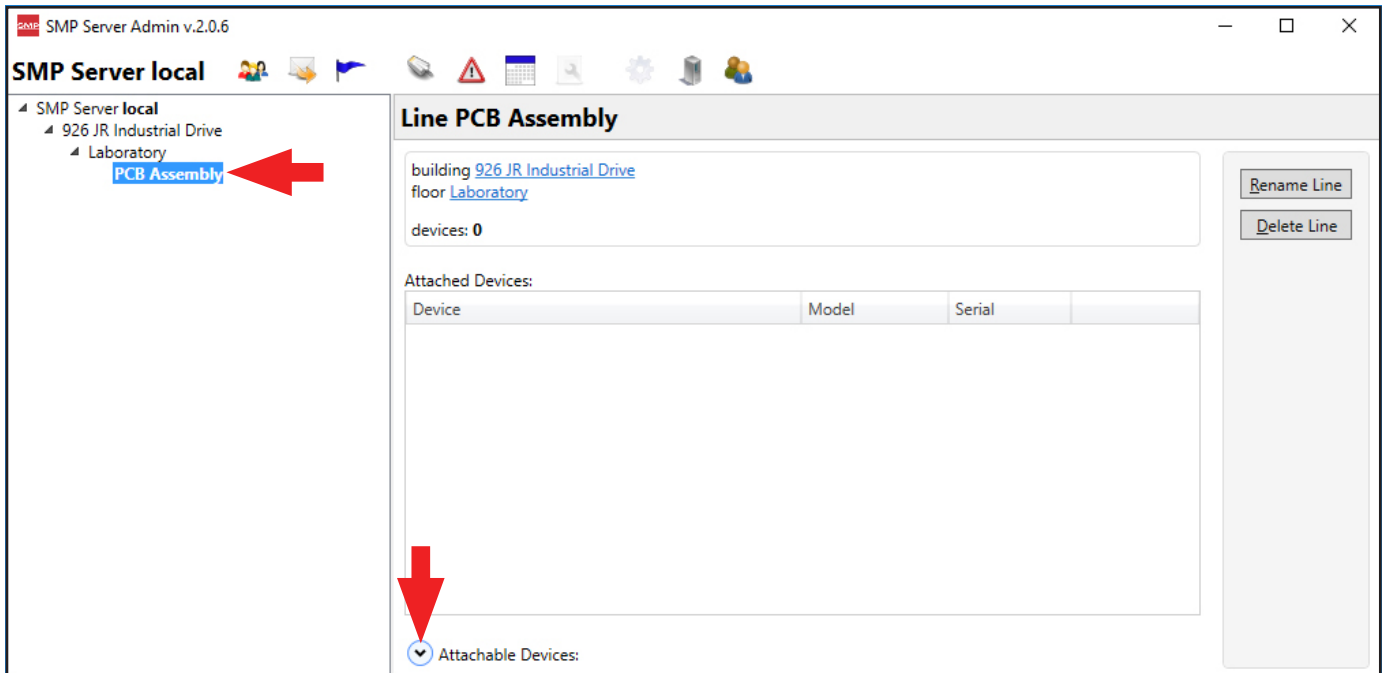

19. The serial number for the Ground Master Monitor will appear. Click attach.

SMP Server Admin v.2.0.6

SMP Server local

- SMP Server local
 - 926 JR Industrial Drive
 - Laboratory
 - PCB Assembly**

Line PCB Assembly

building [926 JR Industrial Drive](#)
floor [Laboratory](#)

devices: 0

Attached Devices:

Device	Model	Serial	
--------	-------	--------	--

Attachable Devices:

Name	Model	Serial	
[E91004000005]	Ground Master	E91004000005	attach

[Rename Line](#)
[Delete Line](#)

20. The Ground Master Monitor will attach to the selected line.

SMP Server Admin v.2.0.6

SMP Server local

- SMP Server local
 - 926 JR Industrial Drive
 - Laboratory
 - PCB Assembly**
[E91004000005]

Line PCB Assembly

building [926 JR Industrial Drive](#)
floor [Laboratory](#)

devices: 1

Attached Devices:

Device	Model	Serial	
[E91004000005]	Ground Master	E91004000005	rename detach

Attachable Devices:

Name	Model	Serial	
------	-------	--------	--

[Rename Line](#)
[Delete Line](#)

21. Open SCS SMP Client.

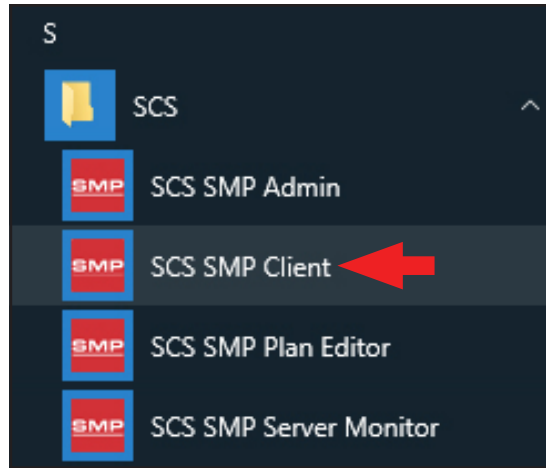

22. Verify that the Ground Master Monitor was added to the appropriate building, floor and line.

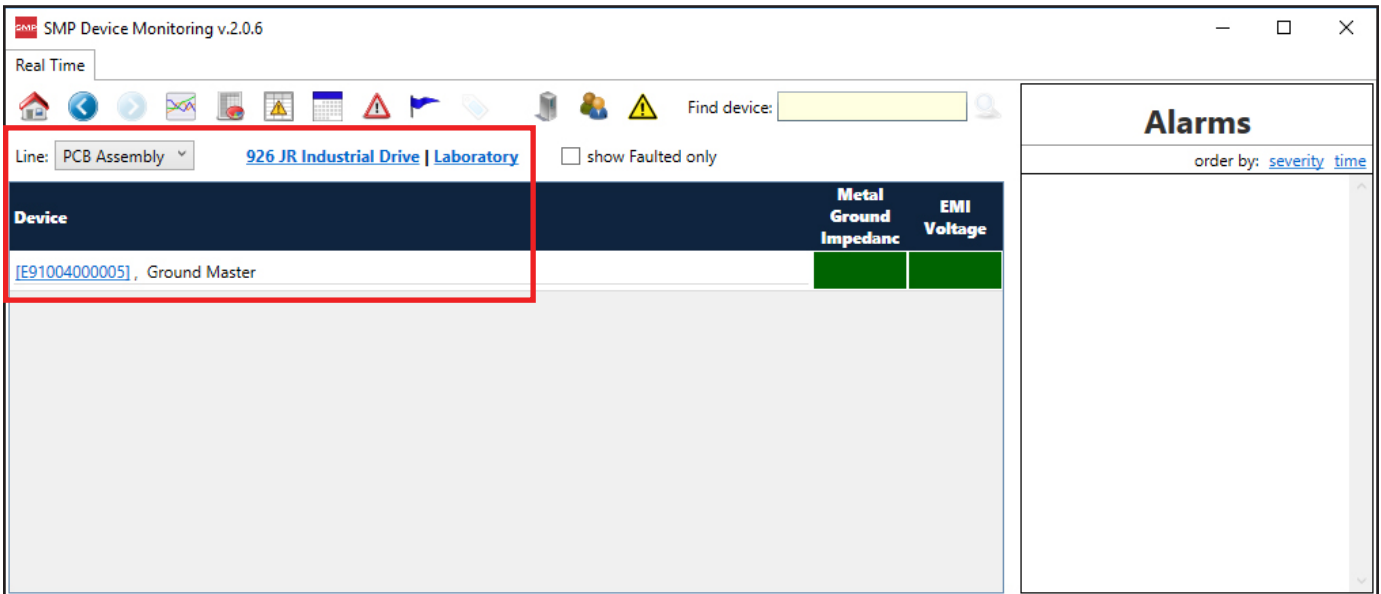

Operation

Use the table below to interpret the behavior of the Ground Master Monitor's tool LED's and audible buzzer (if enabled).

Green LED	Red LED	Buzzer	Status
ON	OFF	OFF	No failures
OFF	ON	ON	Impedance failure
ON	BLINK	OFF	EMI voltage failure
OFF	OFF	OFF	Monitor channel disabled

Maintenance

Cleaning

Disconnect the power adapter from the device. Clean the Ground Master Monitor using a dry brush or vacuum cleaner. Clean its contacts using a contact cleaner or brush, and tighten all connections. Do not reconnect the power adapter until cleaning is finished.

Replacing the Fuses

The monitored equipment may become prone to excessive voltage and significant damage should it lose its connection to ground or be bonded to an improperly wired ground point. In order to prevent the spread of this excessive voltage to other equipment via the Ground Master Monitor, fuses are implemented for each individual ground connection. In the case of excessive voltage on the equipment, the appropriate fuse will disconnect the equipment from the Ground Master Monitor and from the other connected equipment. Ground failure on that particular ground will be immediately indicated.

Before replacing the fuse, always investigate the reason for the fuse blowing, and correct the problem. The fuse should never blow under normal circumstances.

NOTE: Never use wire jumpers in place of fuses. Use only factory-authorized fuses. Disconnect power before replacing any fuses. The fuses are manufactured by Littelfuse®, and its part number is 37301250410.

Calibration

Frequency of recalibration should be based on the critical nature of those ESD sensitive items handled and the risk of failure for the ESD protective equipment and materials. In general, SCS recommends that calibration be performed annually.

Use the SCS CTE701 Workstation Monitor Checker to perform periodic verification (once every 6-12 months) of the Ground Master Monitor. The Workstation Monitor Checker can be used to check the test limits of the Ground Master Monitor without removing it from the factory floor.

See [TB-9031](#) for more information.



Figure 6. SCS CTE701 Workstation Monitor Checker

Specifications

Power

Power Adapter	Output: 12 VDC @ 1.5 A
100-240 VAC	Output Plug Polarization: Center Positive
50-60 Hz	Output Plug: 5.5 mm O.D. x 2.1 mm I.D. x 9.5 mm L

Metal Tool

Amount Monitored	8
Impedance Limit	10 ohms (default)
EMI Voltage Limit	223 mV average amplitude (@ 1.5 MHz)
Test Voltage	80 mV square pulse @ open circuit (80 Hz)
Test Current	<5 mA @ short circuit

Connectivity

Input	18 AWG wire terminal blocks for metal tools
Outputs	18 AWG wire terminal blocks for relay outputs

General

Alarm	LEDs and buzzer
Dimensions	3.54" x 5.52" x 1.18" (90 mm x 140 mm x 30 mm)
Weight	0.4 lbs. (0.18 kg)

Limited Warranty, Warranty Exclusions, Limit of Liability and RMA Request Instructions

See the SCS Warranty - StaticControl.com/Limited-Warranty.aspx