



Wi-Fi 2.4 GHz TERMINAL ANTENNA

Part Numbers: 2195899-1

FEATURES & BENEFITS

- Wi-Fi 2.4 GHz, Bluetooth, ZigBee
- Global Frequency coverage
- Omnidirectional coverage, High Gain
- RoHS compliant

SPECIFICATIONS

Frequency Range (MHz)	2400 - 2500
VSWR	< 1.6:1
Average Efficiency	85 %
Peak Gain	4.9 dBi
Average Gain	-0.7 dBi
Feed Point Impedance	50 ohms
Polarization	Linear
Size	195 mm x 13 mm x 13 mm
Weight	< 25 g
Mounting	RP-SMA Male
Mating Connector	RP-SMA Female
Cable	N/A
Operating Temperature	-40 to +85°C
Storage Temperature	-40 to +85°C
Hazardous Materials	A certificate of conformance is available from the product page on TE website.

RF DATA

VSWR

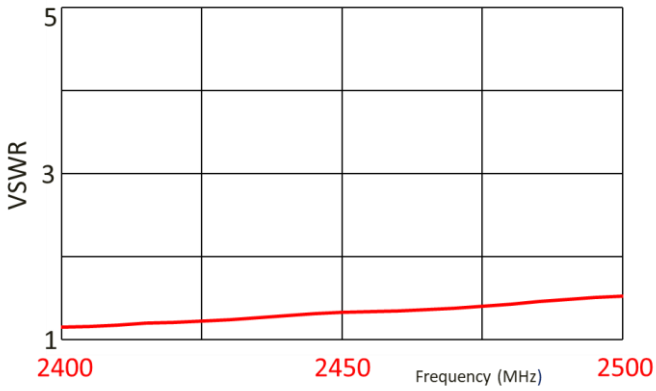

Return Loss

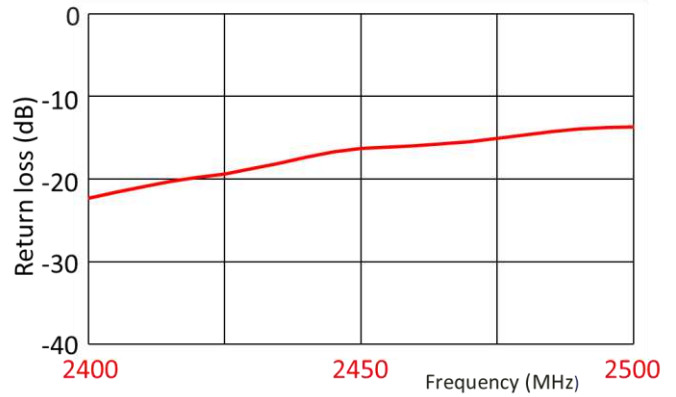

Efficiency

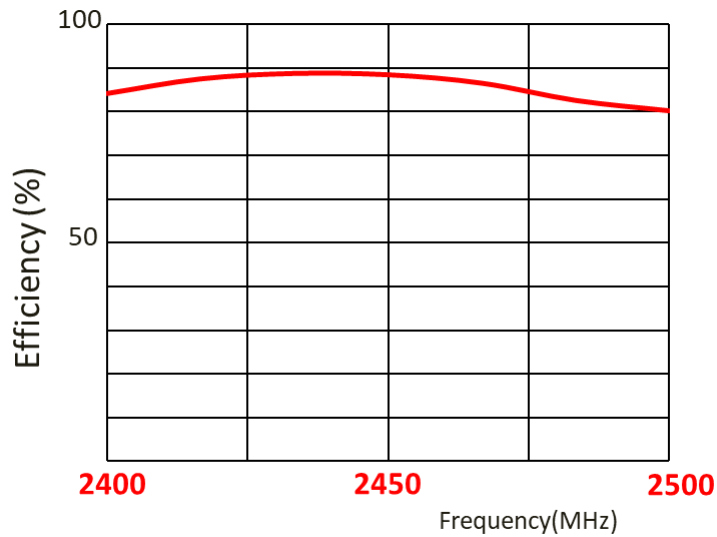

RADIATION PATTERN

Test setup

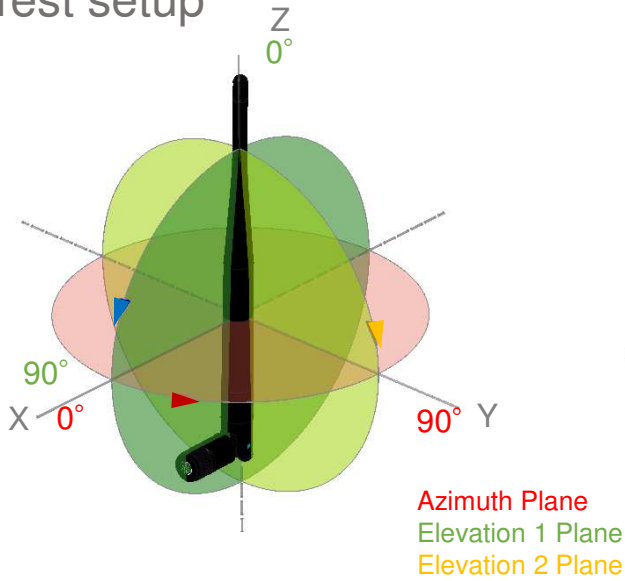

Azimuth

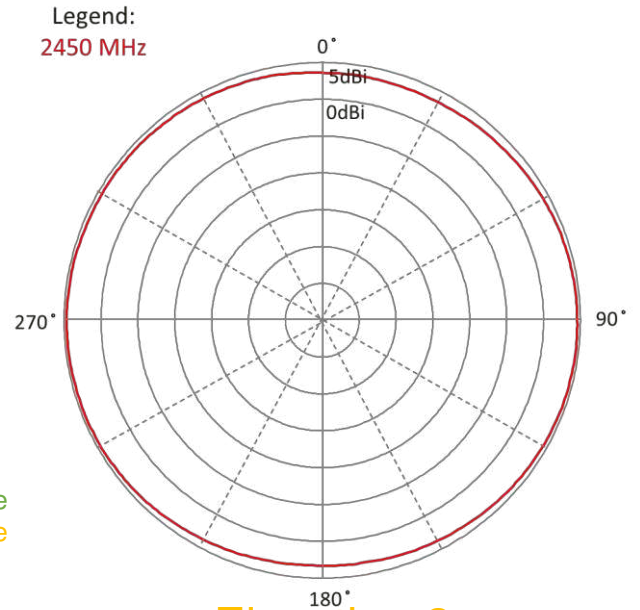

Elevation 1

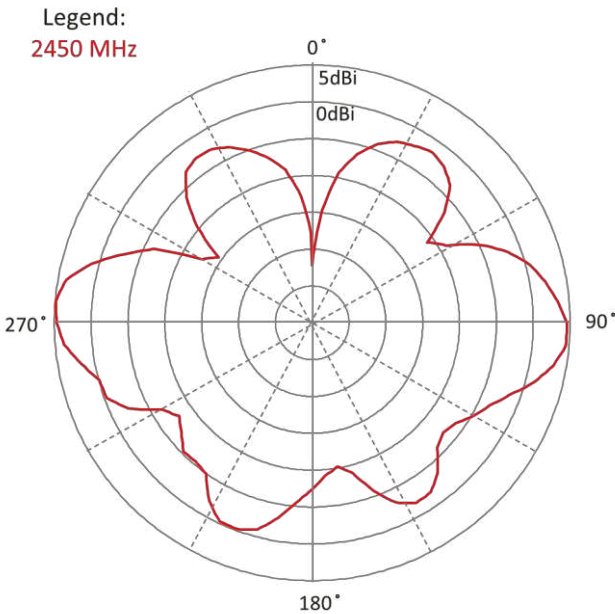

Elevation 2

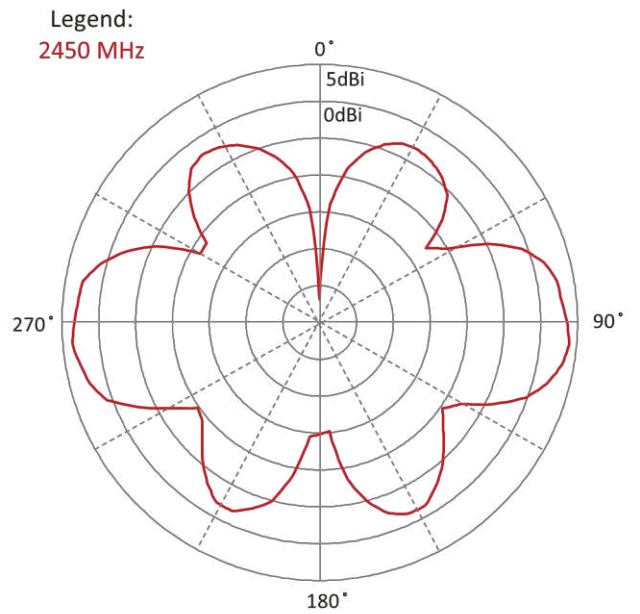

Wi-Fi 2.4 GHz TERMINAL ANTENNA

Standard Antenna Solutions

DIMENSIONS

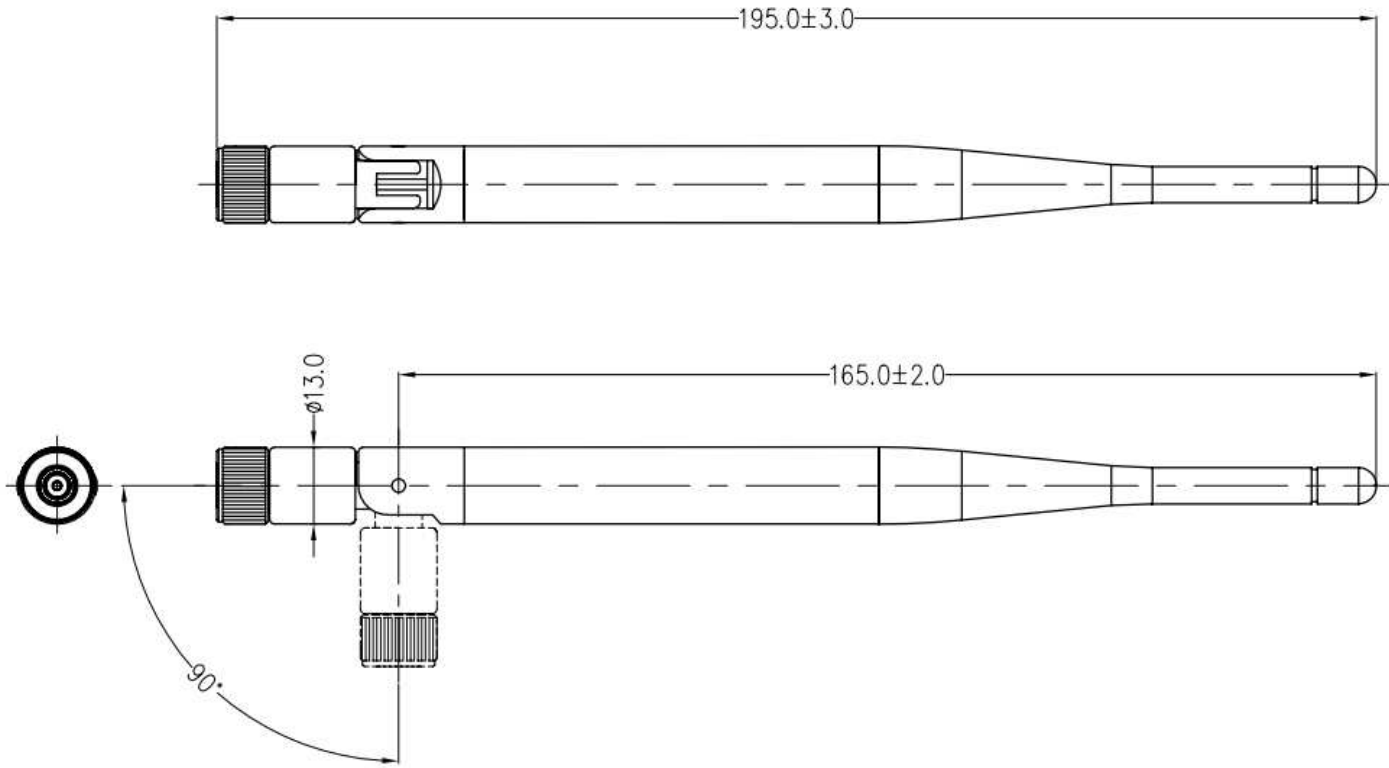

Dimensions: mm
Diagram is not to scale

Wi-Fi 2.4 GHz TERMINAL ANTENNA

Standard Antenna Solutions

PACKAGING

1. Enter OPP bag

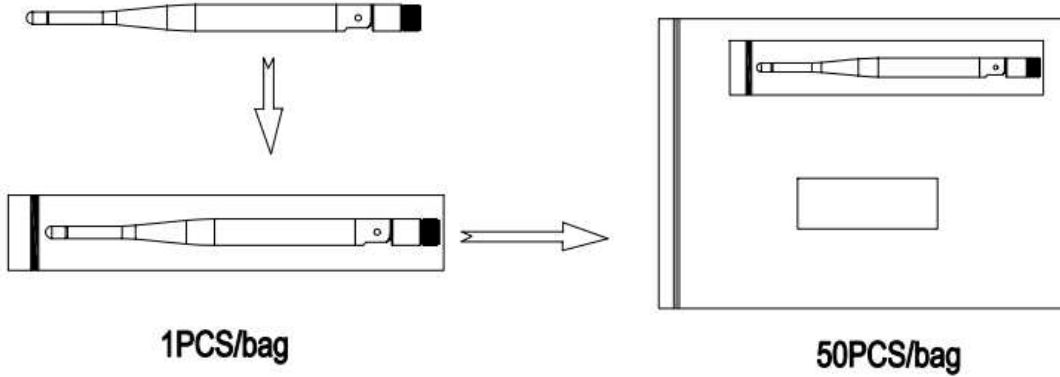

2. PACKING

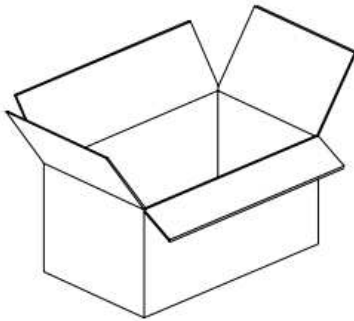

SIZE: 29.0*23.0*32.5cm
300PCS/CARTON

Canada: +1 (905) 475-6222
Mexico: +52 (0) 55-1106-0800
Latin/S. America: +54 (0) 11-4733-2200
Germany: +49 (0) 6251-133-1999
UK: +44 (0) 800-267666
France: +33 (0) 1-3420-8686
Netherlands: +31 (0) 73-6246-999
China: +86 (0) 400-820-6015

For phone numbers in other countries, go to te.com/support-center

te.com

TE Connectivity, TE Connectivity (logo) are trademarks. All other logos, products and/or company names referred to herein might be trademarks of their respective owners.

The information given herein, including drawings, illustrations and schematics which are intended for illustration purposes only, is believed to be reliable. However, TE Connectivity makes no warranties as to its accuracy or completeness and disclaims any liability in connection with its use. TE Connectivity's obligations shall only be as set forth in TE Connectivity's Standard Terms and Conditions of Sale for this product and in no case will TE Connectivity be liable for any incidental, indirect or consequential damages arising out of the sale, resale, use or misuse of the product. Users of TE Connectivity products should make their own evaluation to determine the suitability of each such product for the specific application.

© 2020 TE Connectivity Ltd. family of companies All Rights Reserved.

04/2021

3. SEALING

