

Click [here](#) to ask about the production status of specific part numbers.

MAX77863 Evaluation Kit

Evaluates: MAX77863

General Description

The MAX77863 evaluation kit (EV kit) is a fully assembled and tested printed-circuit board (PCB) that demonstrates the highly-integrated MAX77863 PMIC. The MAX77863 is a complete power management IC (PMIC) for mobile devices using system-on-chip (SoC) application processors. The IC includes four buck regulators, nine low drop-out linear regulators, eight GPIOs, real-time clock (RTC), backup battery charger, bidirectional reset I/O, interrupt output, and a system watchdog timer.

The EV kit uses a MAXUSB daughter board command module that provides the I²C interface to control power sequence, individual regulator output on/off, GPIOs, RTC, and setting the regulator output voltage.

Windows[®]-based software provides a user-friendly graphical interface for easy evaluation.

Features and Benefits

- USB-to-I²C Converter Allows for Easy Communication
 - Level Translator Allows for Adjusting I²C Bus Voltage from 1.8V to 3.3V
- Proven PCB Reference Design and Layout
- Fully Assembled and Tested

[Ordering Information](#) appears at end of data sheet.

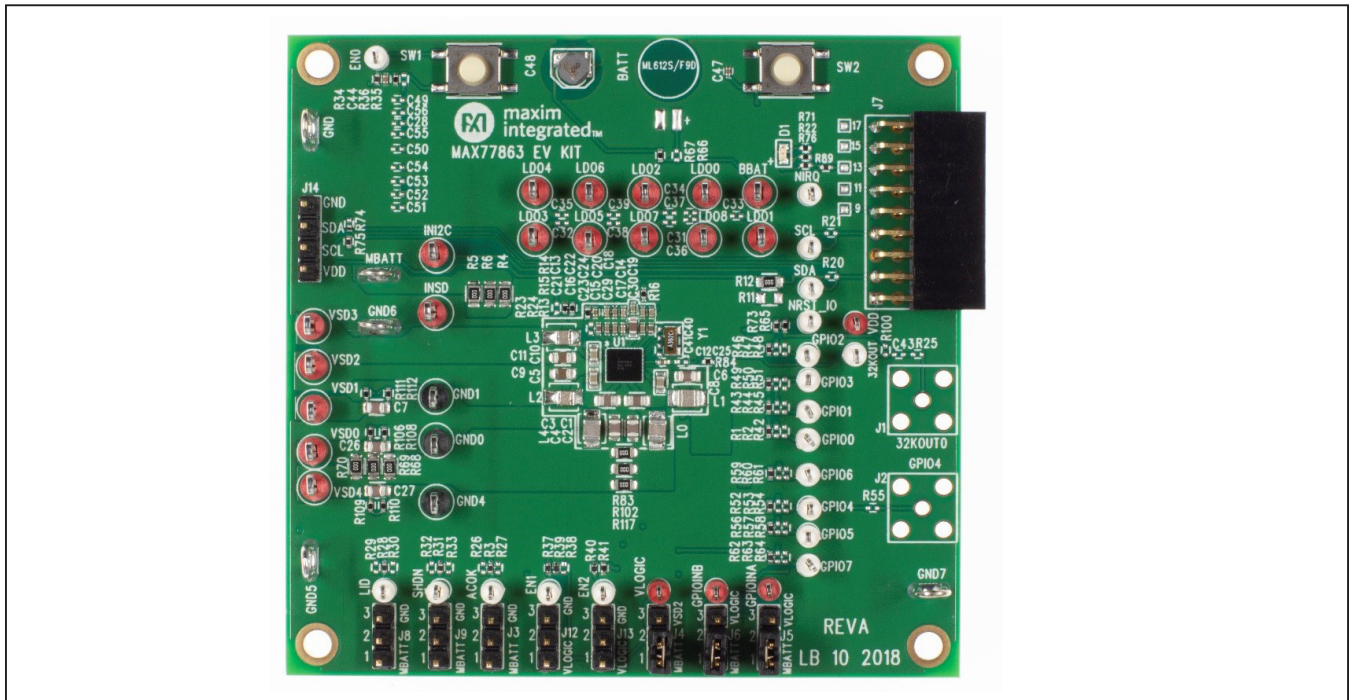

Figure 1. MAX77863 EV Kit Photo

Windows is a registered trademark and registered service mark of Microsoft Corporation.

Quick Start

Follow this procedure to familiarize yourself with the EV kit.

Note: In the following sections, software-related items are identified by bolding. Text in **bold** refers to items directly from the EV kit software. Text in **bold and underlined** refers to items from the Windows operating system.

Required Equipment

- MAX77863 EV kit
- MAXUSB board
- Dual power supply with 6V and 5A capability
- Digital voltmeter (DVM)
- Ammeter
- Micro-USB cable

Procedure

The EV kit is fully assembled and tested. Use the following steps to verify board operation:

- 1) Install all shunts as recommended in [Table 1](#).
- 2) Connect a disabled 3.6V bench power supply through an ammeter to MBATT and GND6 wire loops. Set the input current limit of the bench supply to 1A.
- 3) Enable the output of the 3.6V bench power supply.
- 4) Connect J2 of the MAXUSB to J7 of the EV kit with both boards facing upright (silkscreen up).
- 5) Connect a Micro-B USB cable from J1 of the MAXUSB and the PC.
- 6) Wait a few seconds for your computer to install the USB driver. Once the driver is successfully installed, a Windows pop-up message is shown saying that the “USB Serial Converter” is ready to use.
- 7) Open the MAX77863 GUI.
- 8) In the upper left corner of the GUI, select **Device** → **Connect** as shown in [Figure 2](#). Once connected, a pop-up is shown as in [Figure 3](#). Click on the **Read and Close** button.
- 9) Press and hold SW1 on the EV kit for 1 second.
- 10) See [Table 2](#) for default voltages and FPS settings.

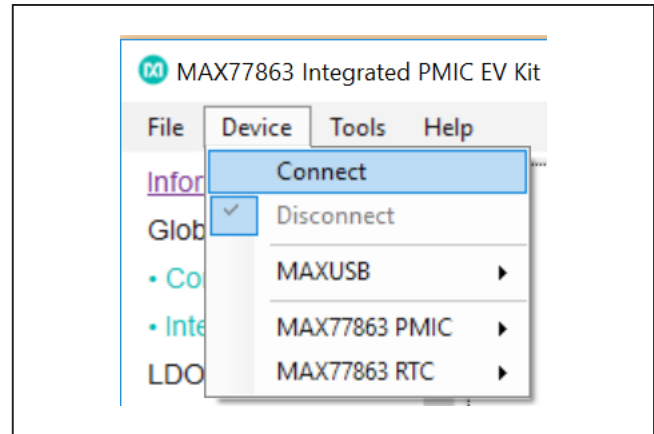

Figure 2. Connecting to the EV Kit

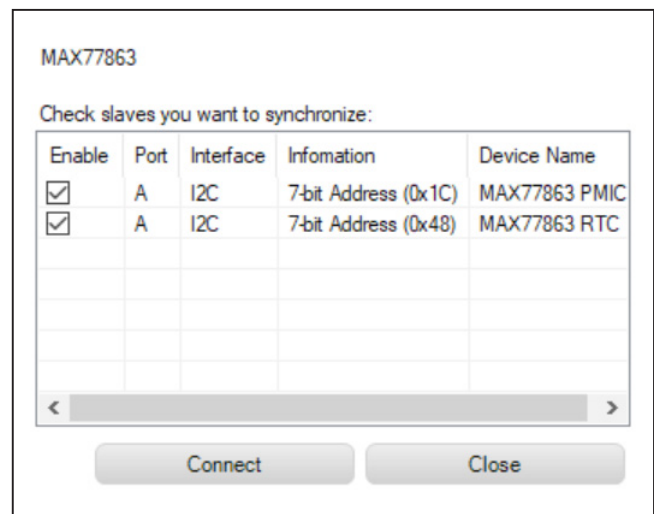

Figure 3. List of Devices

This concludes the initial setup procedure. Users are now encouraged to explore the device and its register settings with the GUI. During this exploration, be mindful of the power supply current limit and input current ammeter’s range so as not to interfere with the operation of the device under test.

Table 1. Default Shunt Positions and Jumper Descriptions

REFERENCE DESIGNATOR	DEFAULT POSITION	FUNCTION
J3	Open	ACOK = Open
J4	1-2	Connects VLOGIC to MBATT
J5	1-2	Connects GPIOINA to MBATT
J6	1-2	Connects GPIOINB to MBATT
J7	Open	Connects MAX77863 EV Kit to MAXUSB Daughter Board
J8	1-2	Connects SHDN to MBATT
J9	1-2	Connects LID to MBATT
J12	2-3	Connects EN1 to GND
J13	1-2	Connects EN2 to VLOGIC

Table 2. Default Flexible Power Sequencing (FPS) Setting (MAX77863A)

OUTPUT	EXPECTED VOLTAGE	FPS SETTING		
		FPS SOURCE	POWER-UP (SLOT)	POWER-DOWN (SLOT)
SD0	0.9	FPS0	2	5
SD1	1.1	FPS0	6	1
SD2	0.9	FPS0	1	6
SD3	1.8	FPS0	0	7
LDO0	1.8	Not Configured	0	0
LDO1	1.8	FPS0	6	1
LDO2	3.3	FPS0	3	4
LDO3	1.8	FPS0	3	4
LDO4	0.8	FPS0	6	1
LDO5	1.8	FPS0	4	3
LDO6	1.8	FPS0	5	2
LDO7	0.85	FPS0	2	5
LDO8	1.8	FPS0	3	4
GPIO1	N/A	FPS0	7	0
GPIO2	N/A	FPS0	7	0
GPIO3	N/A	FPS0	7	0

EV Kit Features

Configuring the Buck Regulators

The IC features several different programmable options to customize the behaviors of the four integrated buck regulators during startup, operation, and shutdown. [Figure 4](#) shows the portion of the GUI window that allows for configuration of the buck regulators. Drag the slider and click **Write** to change the output voltage. Other features of the buck regulators which can be changed here include the power modes, operating modes, and enabling/disabling the active discharge resistors.

SD0 and SD1 also feature a software-controllable remote sense which can be disabled here.

Configuring the LDOs

The IC features several different programmable options to customize the behaviors of the nine integrated LDOs during startup, operation, and shutdown. [Figure 5](#) shows the portion of the GUI window that allows for configuration of the LDOs. Drag the slider and **Click** write to change the output voltage. Other features of the LDOs can also be configured here such as the active discharge resistors and soft-start slew rates.

Configuring the Flexible Power Sequencer

The IC features different power-up/down configurations based on Maxim's flexible power sequencer technology. The power-up/down sequence must be configured prior to any wake-up event and must be reconfigured after any event which causes the registers to reset such as power-down or undervoltage lockout.

To evaluate the device with a different power-up voltage, use the following instructions:

- 1) Follow steps 2-8 of the Quick Start procedure. Do not go to step 9.
- 2) Go to the **"FPS"** section of the GUI and configure the desired power-up/down sequence.
- 3) Press and hold SW1 for 1 second and monitor the PMICs resources. The resources should power-up in the new desired power-up sequence.
- 4) Press and hold SW1 for 3 seconds to initiate a power-down and monitor the PMICs resources. The resources should power-down in the new desired power-down sequence.
- 5) Note that the power-down event resets the device's register settings. The power-up/down sequences need to be rewritten again prior to power-up.
- 6) Different power-up/down sequences can be preprogrammed at the factory.



Figure 4. Step Down Configuration Portion of the EV Kit GUI

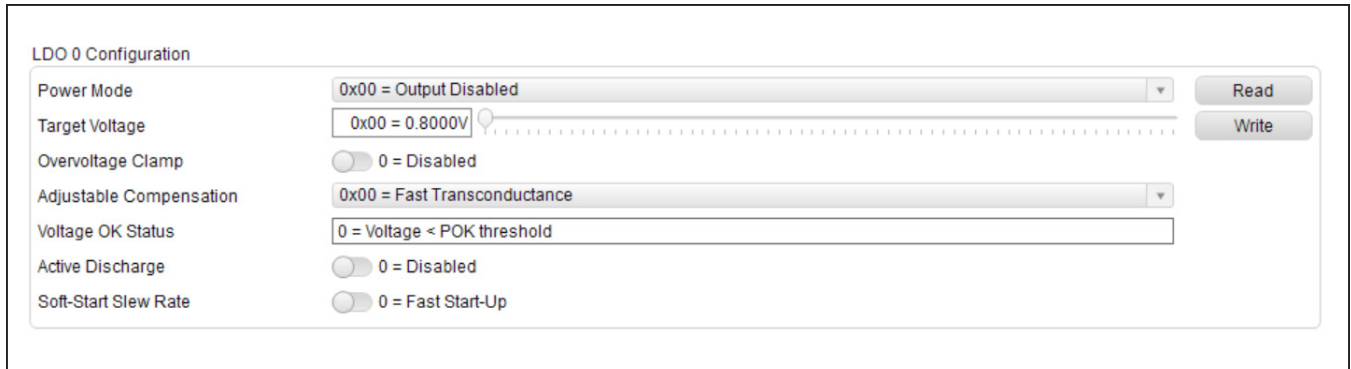

Figure 5. LDO Configuration Portion of the EV Kit GUI

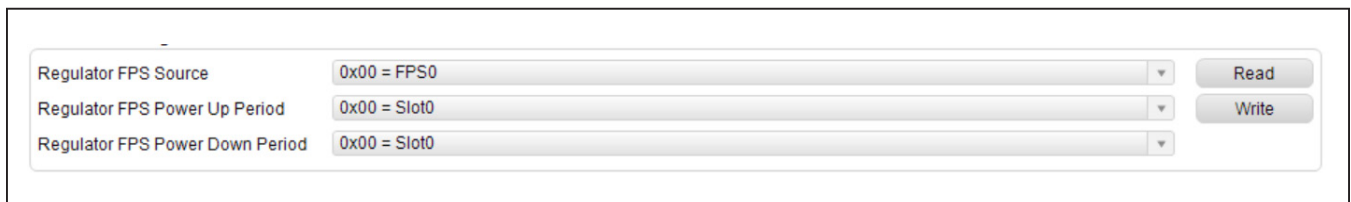

Figure 6. FPS Configuration Portion of the EV Kit GUI

Ordering Information

PART	TYPE
MAX77863EVKIT#	EVKIT

#Denotes RoHS compliant.

MAX77863 EV Kit Bill of Materials

Item	QTY	REFERENCE DESIGNATOR	DESCRIPTION	PART NAME	VALUE	ASSEMBLY INSTRUCTIONS
1	1	BATT	3.0V Manganese Li+ Rechargeable SMD	Panasonic - BSG, ML614S/F9FE (Digi-key P297-ND)		Do not stuff
2	7	C12-13 C42 C44-47	0.1uF, 10V, X5R, Ceramic capacitor, 0402	Murata, GRM155R61A104KA01D	0.1uF	
3	10	C14-20 C22-24	1.0uF, 6.3V, X5R, ±10% Ceramic Capacitor, 0402	Murata, GRM155R60J105KE19D	1.0uF	
4	12	C28 C31 C33-35 C38-39 C49-50 C52-54	1.0uF, 6.3V, X5R, ±10% Ceramic Capacitor, 0402	Murata, GRM155R60J105KE19D	1.0uF	Do not stuff
5	2	C9 C11	10uF, 6.3V, X5R ±20% Ceramic Capacitor, 0805	Taiyo-Yuden, JMK212BJ106MG-T	10uF	
6	3	C5 C8 C10	2.2uF, 6.3V, X5R, ±20%, Ceramic Capacitor, 0603	Taiyo Yuden, JMK107BJ225MA	2.2uF	
7	2	C21 C30	2.2uF, 6.3V, X5R, ±20%, Ceramic Capacitor, 0402	Murata, GRM155R60J225ME19D	2.2uF	
8	5	C32 C36 C51 C55-56	2.2uF, 6.3V, X5R, ±20%, Ceramic Capacitor, 0402	Murata, GRM155R60J225ME19D	2.2uF	Do not stuff
9	6	C2 C4 C6-7 C26-27	22uF, 6.3V, X5R, ±20%, Ceramic Capacitor, 0805	Taiyo-Yuden, JMK212BJ226KA	22uF	
10	2	C1 C3	4.7uF, 6.3V, X5R, ±20%, Ceramic Capacitor, 0805	Taiyo Yuden, JMK212BJ475KG	4.7uF	
11	1	C29	4.7uF, 6.3V, X5R, ±20%, Ceramic Capacitor, 0603	Murata, GRM188R60J475KE19D	4.7uF	
12	1	C37	4.7uF, 6.3V, X5R, ±20%, Ceramic Capacitor, 0603	Murata, GRM188R60J475KE19D	4.7uF	Do not stuff
13	4	C25 C40-41 C43	Open ceramic capacitor, 0402		OPEN	Do not stuff
14	1	C57	100uF, 6.3V, Tantalum Capacitor, 1210	AVX, TCJB107M006R0045	100uF	
15	1	J7	2X9 RIGHT ANGLE RECEPTACLE(0.1IN)	Sullins, PPPC092LJBN-RC		
16	1	C48	0.02F 3.3V Coin Capacitor, 3.8mm diameter, 1.55mm max height.	Seiko Instruments Inc., XH311HG-IV07E	0.02F	
17	1	J14	1x4 HEADER 0.1"	SAMTEC, TSW-150-05-T-S (Digi-key, SAM1019-50-ND) this is a 1x50 header then is hand cut to 1x4		
18	8	J3-6 J8-9 J12-13	1x3 HEADER 0.1"	SAMTEC, TSW-150-05-T-S (Digi-key, SAM1019-50-ND) this is a 1x50 header then is hand cut to 1x3		
19	3	L0 L1 L4	1uH, 4.2A, 33mOhm Inductor	Toko, DFE252012F-1R0M	1uH	
20	2	L2 L3	1uH, 3.5A, 40mOhm Inductor	Toko, DFE201612E-1R0M	1uH	
21	1	D1	Surface Mount LED RED, 0603	LITE-ON, LTST-C190YKT		
22	5	GND GND5-7 MBATT	EVK KIT PARTS; MAXIM PAD; WIRE; NATURAL; SOLID; WEICO WIRE; SOFT DRAWN BUS TYPE-S; 20AWG	WEICO WIRE, 9020 BUSS	Maxim Pad	
23	1	U1	9X10 WLP PMIC	Maxim, MAX77863AEWJ+		
24	10	R4-6 R12 R68-70 R83 R102 R117	0 ohm SMT Resistor, 0805		0	
25	20	R24 R36 R67 R13-14 R16 R80-82 R17 R84-85 R18 R106 R108-112 R19	0 ohm SMT Resistor, 0402		0	
26	4	R22 R39 R41 R65	100K SMT Resistor, 0402		100K	
27	19	R1 R3 R28 R31 R34 R37 R40 R43 R46 R49 R52 R56 R59 R62 R73-76 R89	22 ohm SMT Resistor, 0402		22	
28	1	R71	220 ohm SMT Resistor, 0402		220	
29	32	R2 R15 R20-21 R23 R25-27 R29-30 R32-33 R35 R38 R42 R44-45 R47-48 R50-51 R53-55 R57-58 R60-61 R63-64 R66 R100	Open SMT Resistor, 0402		open	Do not stuff
30	1	R11	Open SMT Resistor, 0805		open	Do not stuff
31	2	J1-2	SMA 50 Ohm straight PC Mount Jack Receptacle	Johnson, 142-0701-231		Do not stuff
32	2	SW1-2	Switch, momentary, normally open	Panasonic, EVQ-Q2K03W		
33	22	9 11 13 15 BBAT INI2C INSD LDO0-8 VSD0-4	Test Point, Red	Keystone, 5010 (Digikey Part Number 5010K-ND)		
34	4	GPIOINA GPIOINB VDD VLOGIC	Test Point, Red	Keystone, 5000 (Digikey Part Number 5000K-ND)		
35	19	EN0-2 GPIO0-2 LID NIRQ NRST_IO SCL SDA SHDN ACOK 32KOUT GPIO3-7	Test Point, White	Keystone, 5002 (Digikey Part Number 5002K-ND)		
	1	PACK-OUT	MAXUSB_INTERFACE BOARD, MAXIM	MAXUSB_INTERFACE		Please include this in box stock
36	3	GND1 GND4 GND0	Test Point, Black	Keystone, 5011 (Digikey Part Number 5011K-ND)		
37	1	Y1	Crystal Oscillator, 32.768kHz	EPSON, FC-13532.7680KA-A	32.768khz	

MAX77863 EV Kit Schematic

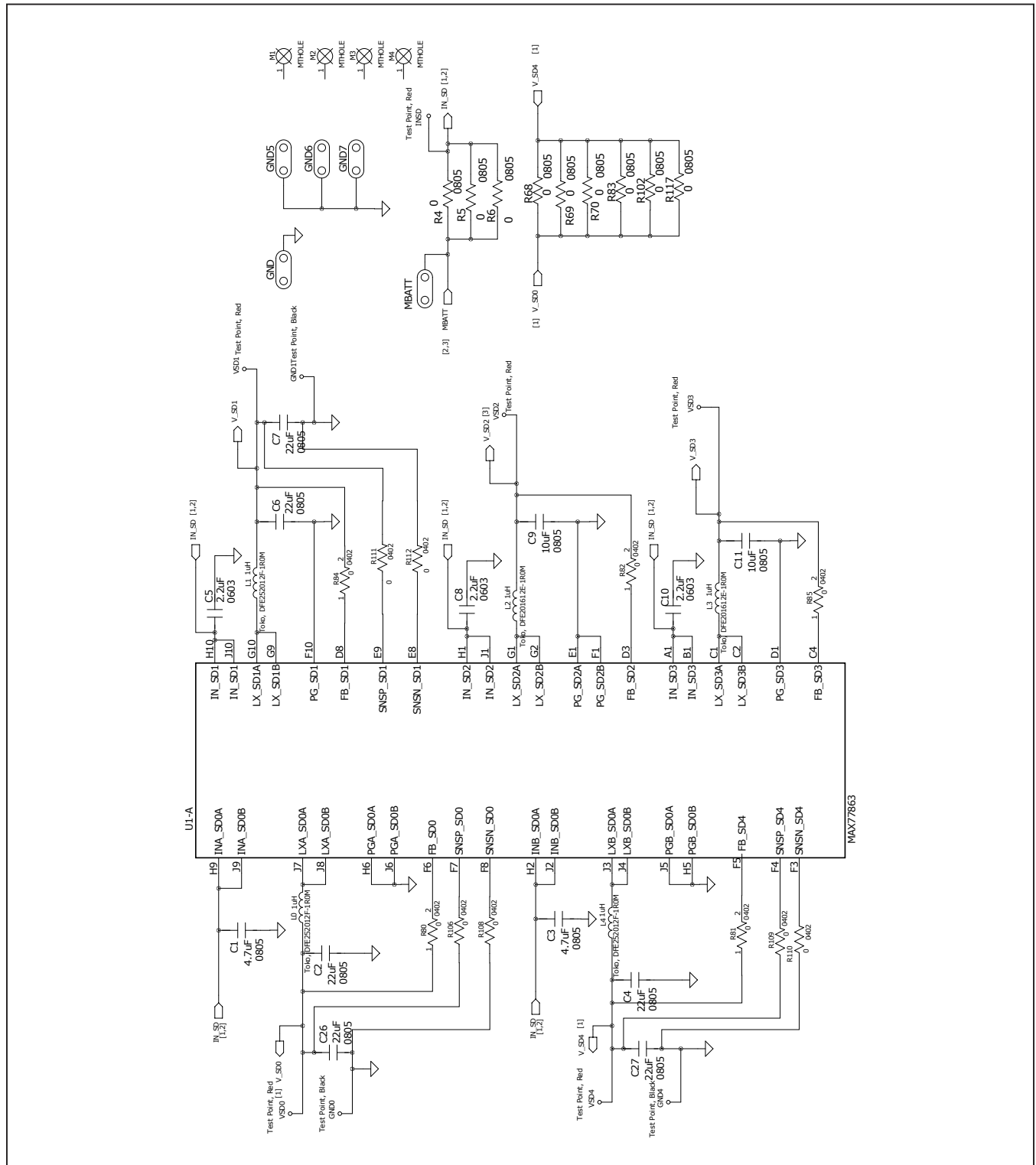

MAX77863 EV Kit Schematic (continued)

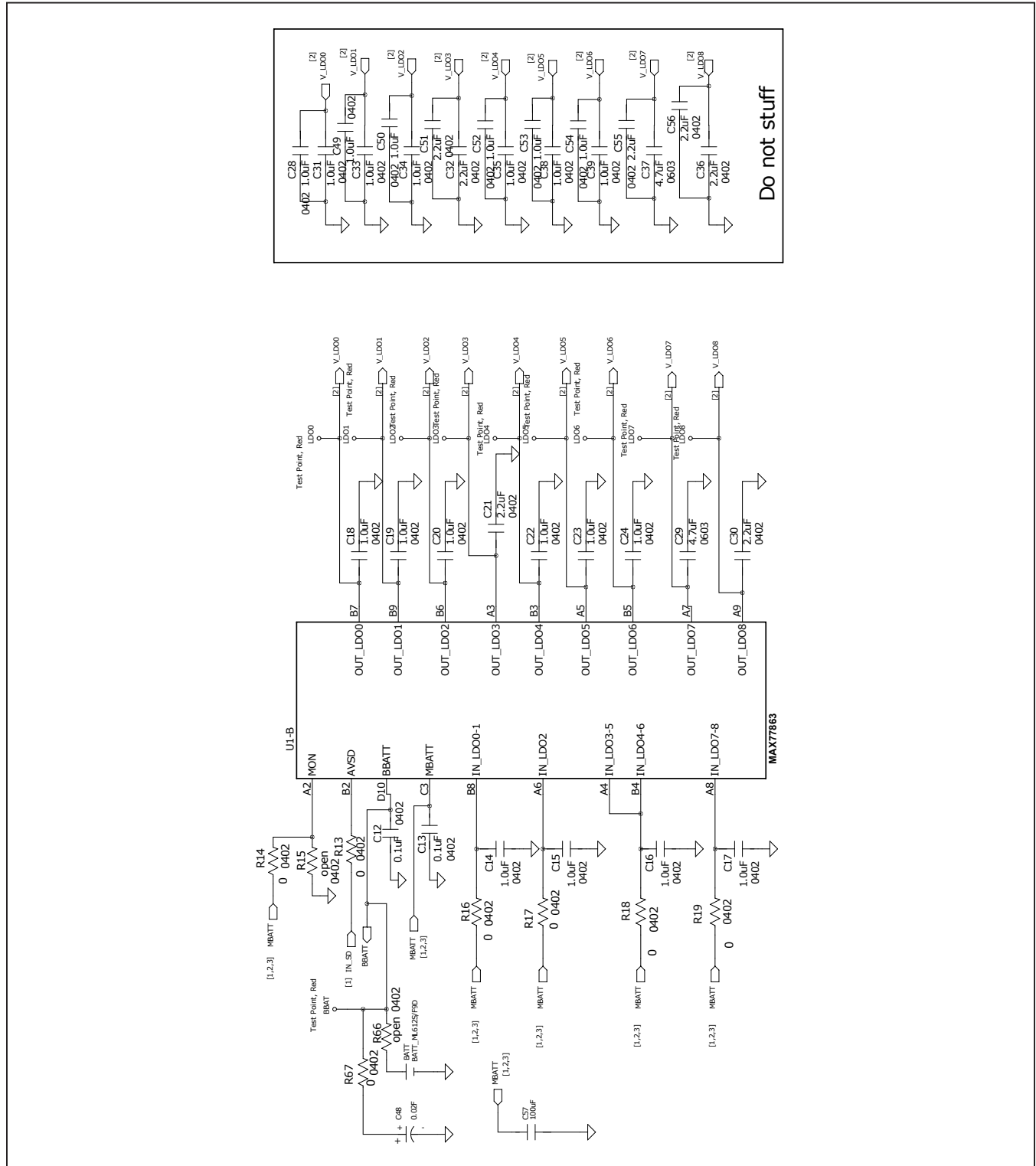

MAX77863 EV Kit Schematic (continued)

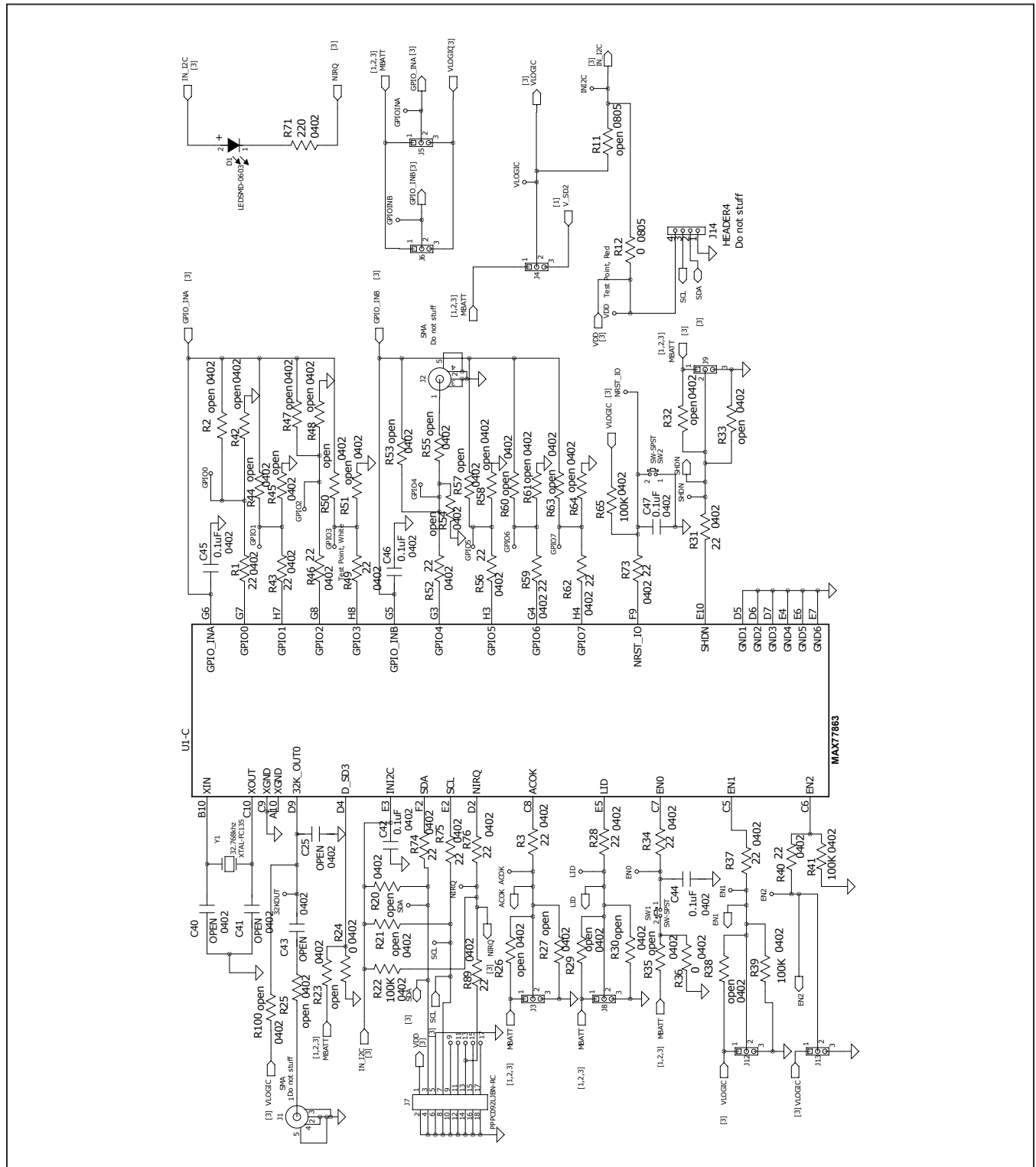

MAX77863 EV Kit Schematic

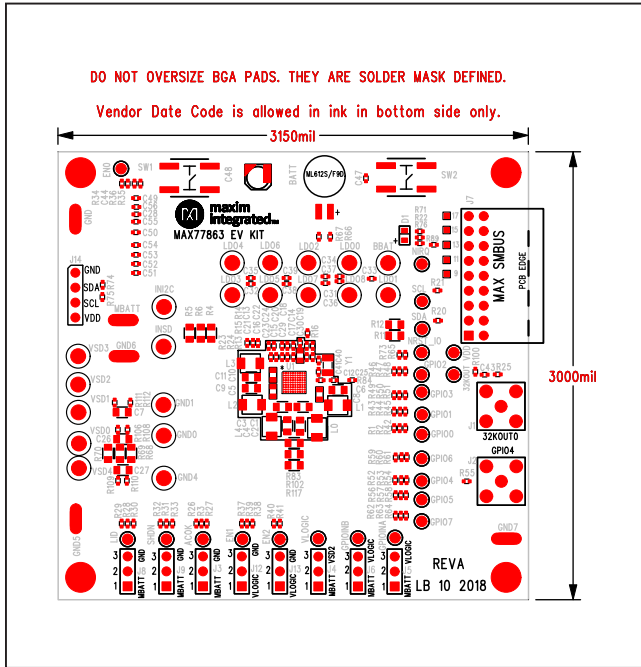

MAX77863 EV Kit Component Placement Guide—Top Silkscreen

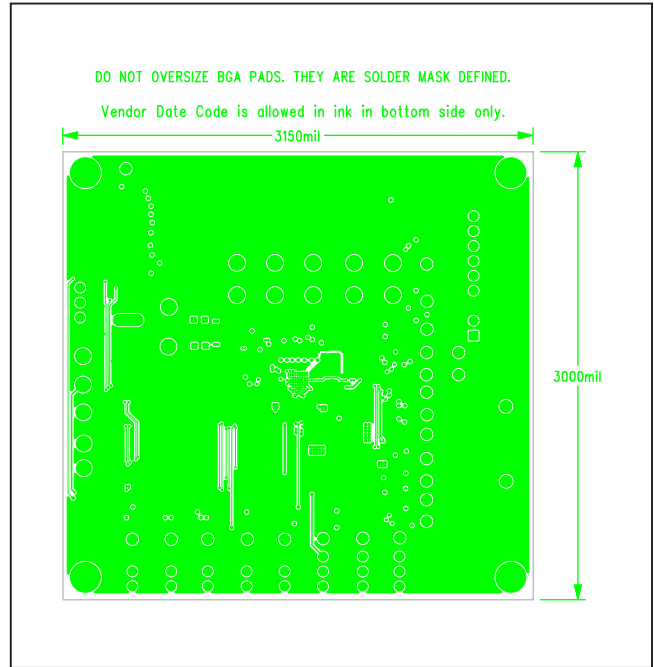

MAX77863 EV Kit PCB Layout—Layer 2 Route + GND

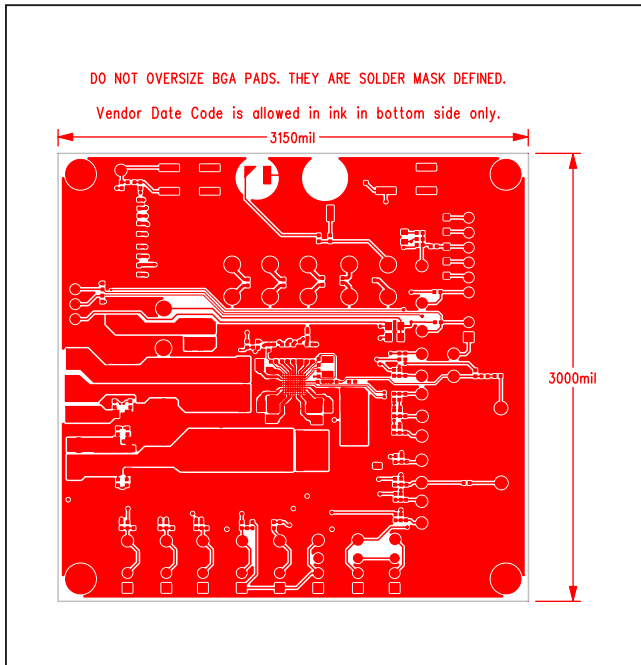

MAX77863 EV Kit PCB Layout—Top Layer

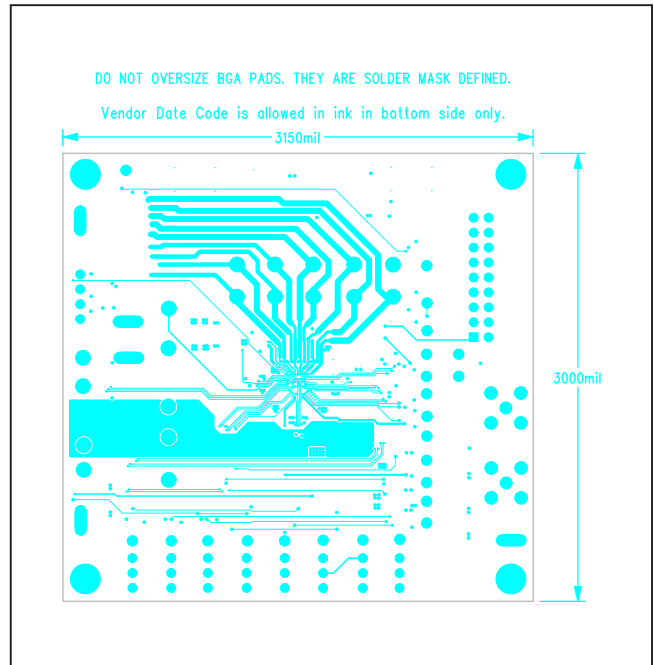

MAX77863 EV Kit PCB Layout—Layer 3 Routing

MAX77863 EV Kit Schematic

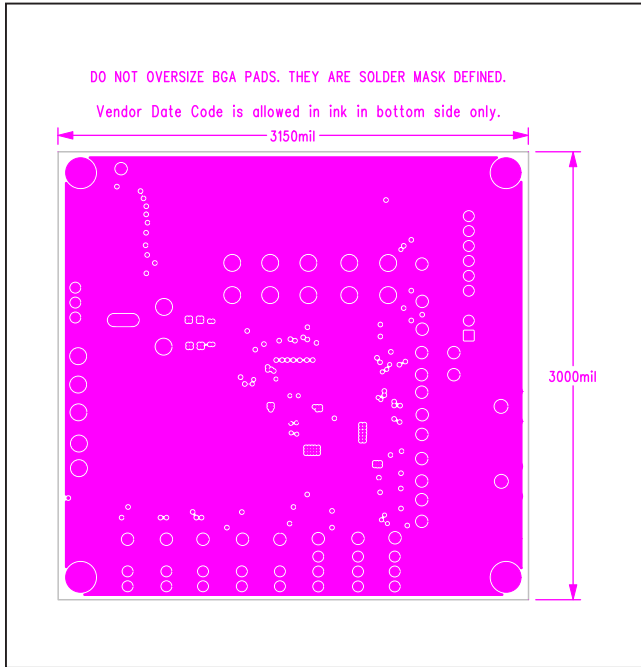

MAX77863 EV Kit PCB Layout—Layer 4 GND

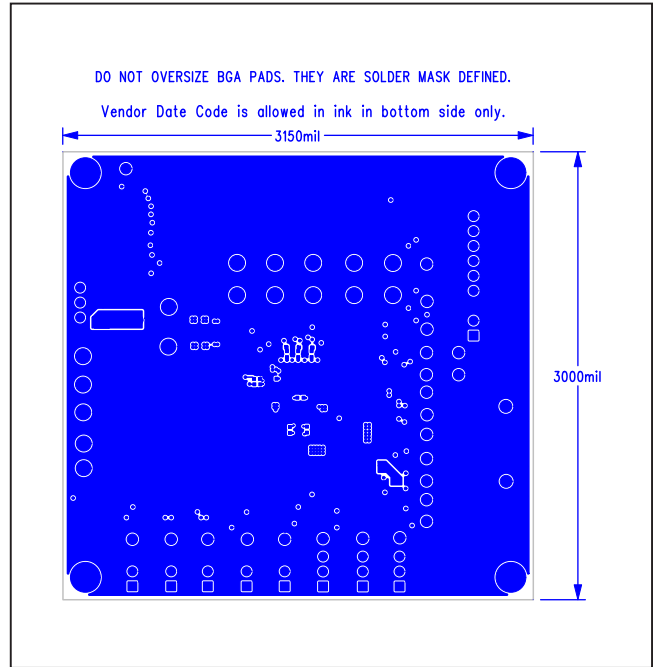

MAX77863 EV Kit PCB Layout—Bottom Layer

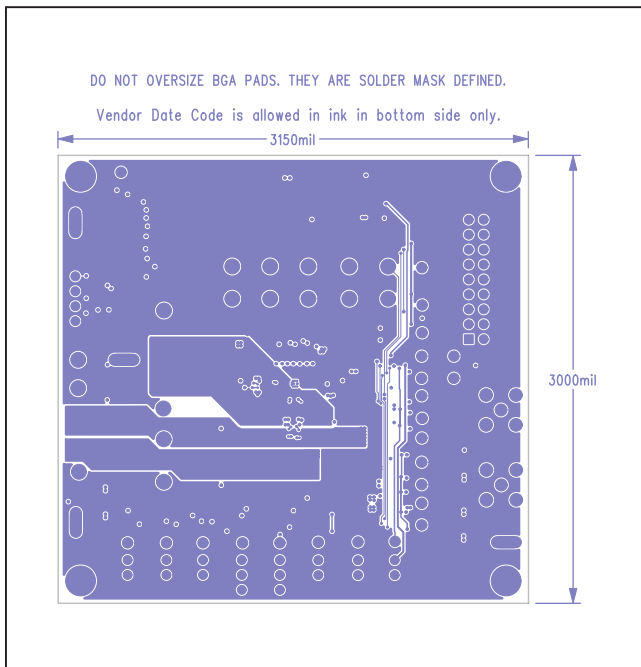

MAX77863 EV Kit PCB Layout—Layer 5 Power

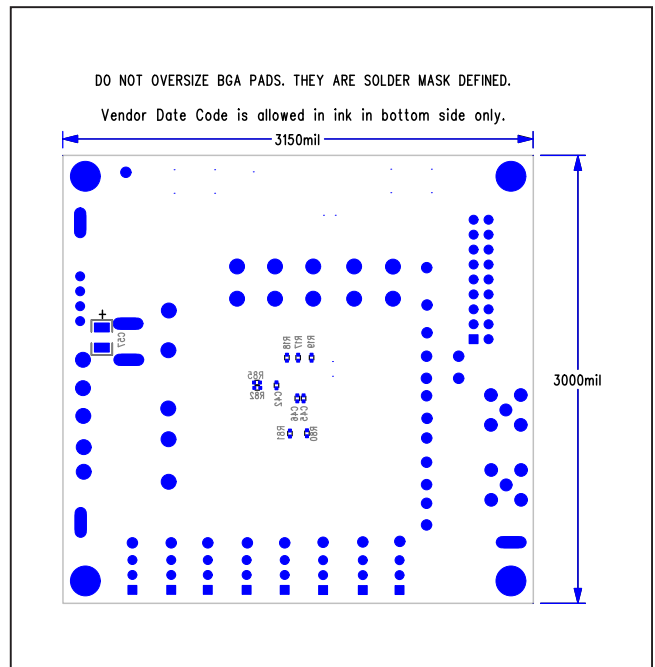

MAX77863 EV Kit PCB Layout—Bottom Silkscreen

Revision History

REVISION NUMBER	REVISION DATE	DESCRIPTION	PAGES CHANGED
0	10/19	Initial release	—
1	6/20	Replaced schematic and corrected typos	1-3, 7-9

For pricing, delivery, and ordering information, please visit Maxim Integrated's online storefront at <https://www.maximintegrated.com/en/storefront/storefront.html>.

Maxim Integrated cannot assume responsibility for use of any circuitry other than circuitry entirely embodied in a Maxim Integrated product. No circuit patent licenses are implied. Maxim Integrated reserves the right to change the circuitry and specifications without notice at any time.