

ALF80G202KP450

Aliases (A557KW202M450G)

ALF80, Aluminum Electrolytic, 2,000 uF, 20%, 450 VDC, -40/+105°C

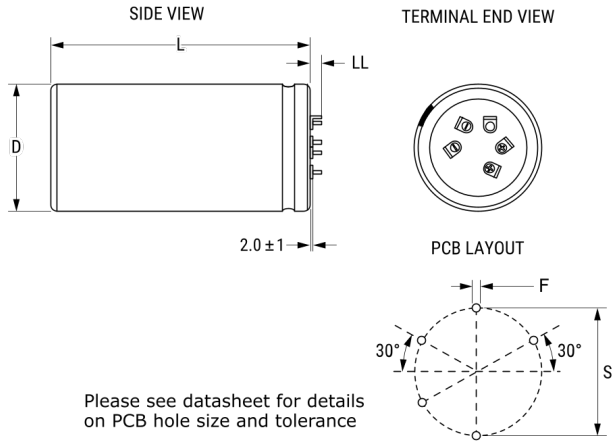

Please see datasheet for details on PCB hole size and tolerance

Click [here](#) for the 3D model.

Dimensions

D	50mm +1mm
L	105mm +/-2mm
S	25mm +/-0.1mm
LL	5.5mm +/-1mm
F	1.486mm +/-0.076mm

Packaging Specifications

Sleeving	Yes
Packaging	Bulk

General Information

Series	ALF80
Dielectric	Aluminum Electrolytic
Style	Press-Fit
Description	Press-Fit, Aluminum Electrolytic
RoHS	Yes
Lead	5 Pin Press-Fit
AEC-Q200	No
Component Weight	310 g
Notes	Dimensions D And L Include Sleeving.
Shelf Life	156 Weeks

Specifications

Capacitance	2,000 uF
Capacitance Tolerance	20%
Voltage DC	450 VDC, 495 VDC (Surge)
Temperature Range	-40/+105°C
Rated Temperature	105°C
Life	9000 Hrs (Rated Voltage and Ripple Current at 105C), 14000 Hrs (Rated Voltage at 105C)
Resistance	84.28 mOhms (100Hz 20C), 54.79 mOhms (10kHz 20C)
Ripple Current	7.582 Amps (100Hz 105C), 15.77 Amps (10kHz 105C)
Leakage Current	2700 uA (5min 20°C)