

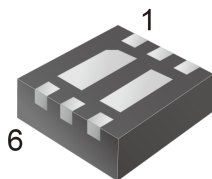

TDFN 2x2



Pin Definition:

- | | |
|----------|------------|
| 1. Anode | 6. Cathode |
| 2. NC | 5. Gate |
| 3. Drain | 4. Source |

PRODUCT SUMMARY

V_{DS} (V)	$R_{DS(on)}$ (m Ω)	I_D (A)
-20	94 @ $V_{GS} = -4.5V$	-2.8
	131 @ $V_{GS} = -2.5V$	-2.3
	185 @ $V_{GS} = -1.8V$	-0.54

SCHOTTKY PRODUCT SUMMARY

V_R (V)	V_F (V)	I_F (A)
20	0.5	2

Features

- Configuration with MOSFET and Low Vf SKY
- Package low profile 0.75mm (Typ)
- Independent Pin Out for Design Flexibility

Application

- Load Switch for Portable Applications
- DC-DC Buck Circuit
- Li-ion Battery Applications
- Cellular Charger Switch

Ordering Information

Part No.	Package	Packing
TSM301K12CQ RFG	TDFN 2x2	3Kpcs / 7" Reel

Note: "G" denotes for Halogen Free

MOSFET Absolute Maximum Rating ($T_A=25^\circ C$ unless otherwise noted)

Parameter	Symbol	Limit	Unit
Drain-Source Voltage	V_{DS}	-20	V
Gate-Source Voltage	V_{GS}	± 12	V
Continuous Drain Current (Note 1,2)	I_D	-4.5	A
Pulsed Drain Current	I_{DM}	-8	A
Maximum Power Dissipation	P_D	$T_C=25^\circ C$	6.5
		$T_A=25^\circ C$ (Note 2)	1.56
Operating Junction Temperature	T_J	+150	$^\circ C$
Operating Junction and Storage Temperature Range	T_J, T_{STG}	- 55 to +150	$^\circ C$

Schottky Absolute Maximum Rating ($T_A=25^\circ C$ unless otherwise noted)

Parameter	Symbol	Limit	Unit
Reverse Voltage	V_R	20	V
Average Forward Current (Note 1,2)	I_F	2	A
Pulsed Forward Current	I_{FM}	5	A
Maximum Power Dissipation (Note 1)	P_D	$T_C=25^\circ C$	6.8
		$T_A=25^\circ C$ (Note 2)	1.47

Block Diagram

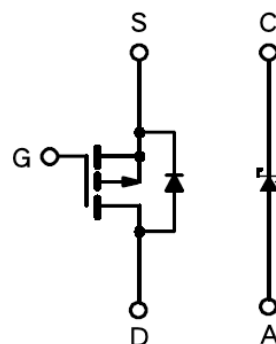

P-Channel MOSFET with Schottky Diode

Thermal Resistance Ratings

Parameter	Symbol	Limit	Unit	
MOSFET				
Thermal Resistance-Junction to Ambient	$T \leq 5s$	$R\theta_{JA}$	80	$^{\circ}C/W$
	Steady State		120	$^{\circ}C/W$
Schottky				
Thermal Resistance-Junction to Ambient	$T \leq 5s$	$R\theta_{JA}$	85	$^{\circ}C/W$
	Steady State		130	$^{\circ}C/W$

Notes:

- Surface mounted on 1" x 1" (2 oz) FAR4 board,
- $t \leq 5s$

MOSFET Electrical Specifications (Ta = 25°C unless otherwise noted)

Parameter	Conditions	Symbol	Min	Typ	Max	Unit
Static						
Drain-Source Breakdown Voltage	$V_{GS} = 0V, I_D = -250\mu A$	BV_{DSS}	-20	--	--	V
Gate Threshold Voltage	$V_{DS} = V_{GS}, I_D = -250\mu A$	$V_{GS(TH)}$	-0.5	--	--	V
Gate Body Leakage	$V_{GS} = \pm 12V, V_{DS} = 0V$	I_{GSS}	--	--	± 100	nA
Zero Gate Voltage Drain Current	$V_{DS} = -20V, V_{GS} = 0V$	I_{DSS}	--	--	-1	μA
Drain-Source On-State Resistance ^a	$V_{GS} = -4.5V, I_D = -2.8A$	$R_{DS(ON)}$	--	--	94	m Ω
	$V_{GS} = -2.5V, I_D = -2.3A$		--	--	131	
	$V_{GS} = -1.8V, I_D = -0.54A$		--	--	185	
Diode Forward Voltage	$I_S = -1.6A, V_{GS} = 0V$	V_{SD}	--	--	-1.2	V
Dynamic^b						
Total Gate Charge	$V_{DS} = -6V, I_D = -2.8A, V_{GS} = -5V$	Q_g	--	5.2	10	nC
Gate-Source Charge		Q_{gs}	--	1.36	--	
Gate-Drain Charge		Q_{gd}	--	0.6	--	
Input Capacitance	$V_{GS} = 0V, V_{DS} = -6V, f = 1.0MHz$	C_{iss}	--	5.2	--	pF
Output Capacitance		C_{oss}	--	9.7	--	
Reverse Transfer Capacitance		C_{rss}	--	19	--	
Switching^c						
Turn-On Delay Time	$V_{DS} = -15V, R_D = 15\Omega, R_G = 6\Omega, V_{GS} = -10V$	$t_{d(on)}$	--	29	--	nS
Turn-On Rise Time		t_r	--	295	--	
Turn-Off Delay Time		$t_{d(off)}$	--	170	--	
Turn-Off Fall Time		t_f	--	65	--	

Schottky Electrical Specifications (Ta = 25°C unless otherwise noted)

Parameter	Conditions	Symbol	Min	Typ	Max	Unit
Forward Voltage Drop	$I_F = 1A$	V_F	--	--	0.5	V
Maximum Reverse Leakage Current	$V_R = 5V$	I_{Rm}	--	0.015	0.08	mA
	$V_R = 20V$		--	0.02	0.10	
Junction Capacitance	$V_R = 10V$	C_T	--	60	--	pF

Notes:

- pulse test: $PW \leq 300\mu S$, duty cycle $\leq 2\%$
- For DESIGN AID ONLY, not subject to production testing.
- Switching time is essentially independent of operating temperature.

MOSFET Electrical Characteristics Curve (Ta = 25°C, unless otherwise noted)

Output Characteristics

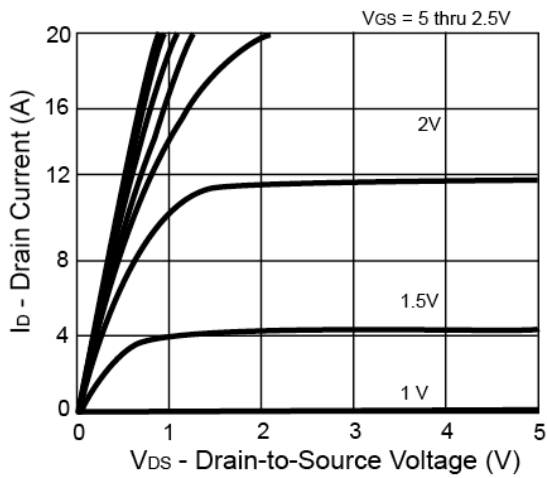

Transfer Characteristics

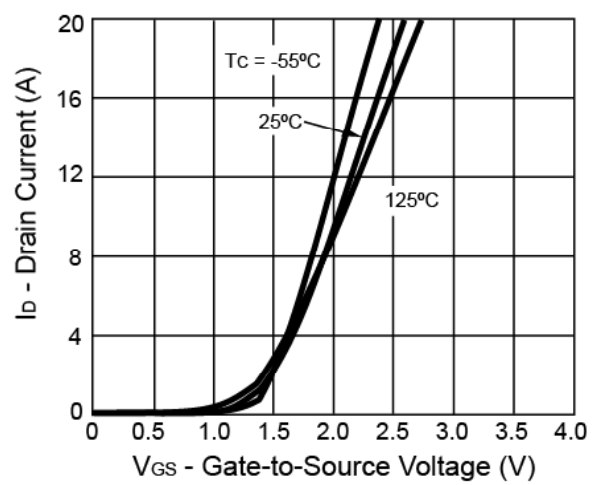

On-Resistance vs. Drain Current

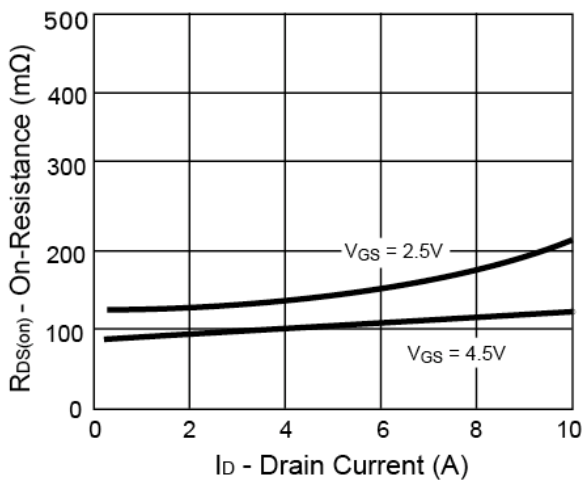

Gate Charge

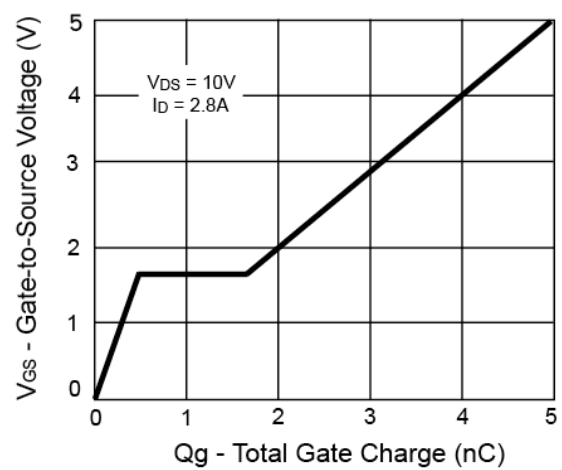

On-Resistance vs. Junction Temperature

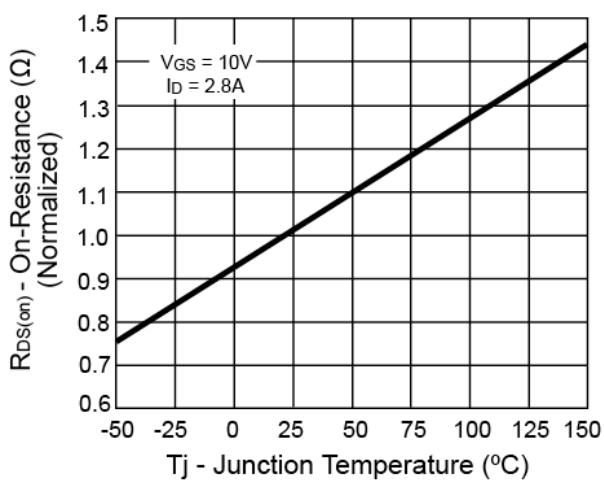

Source-Drain Diode Forward Voltage

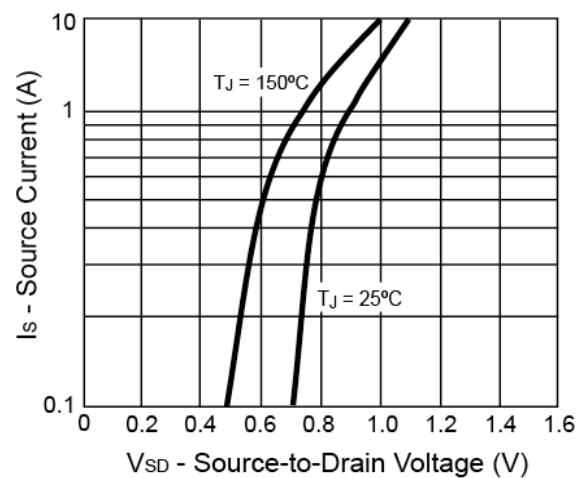

Electrical Characteristics Curve ($T_a = 25^\circ\text{C}$, unless otherwise noted)

On-Resistance vs. Gate-Source Voltage

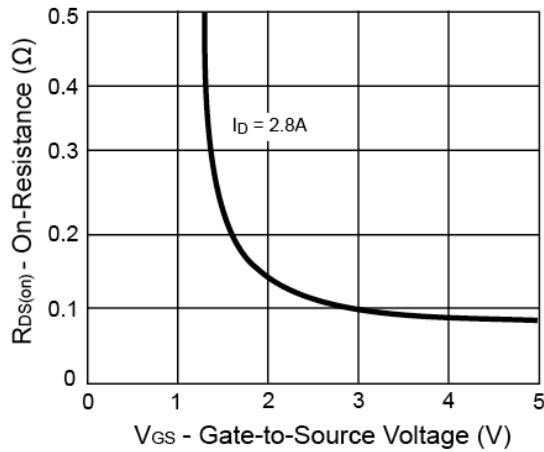

Threshold Voltage

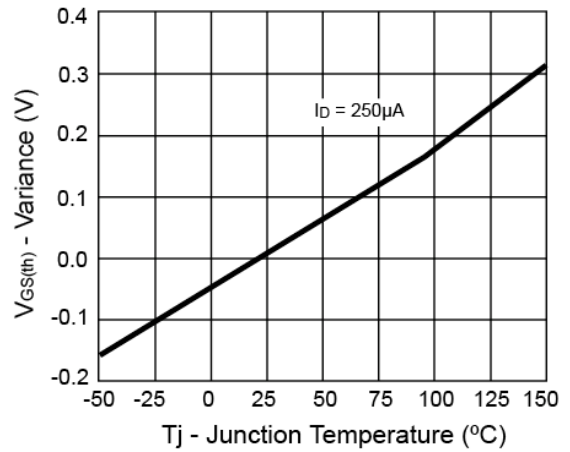

Single Pulse Power

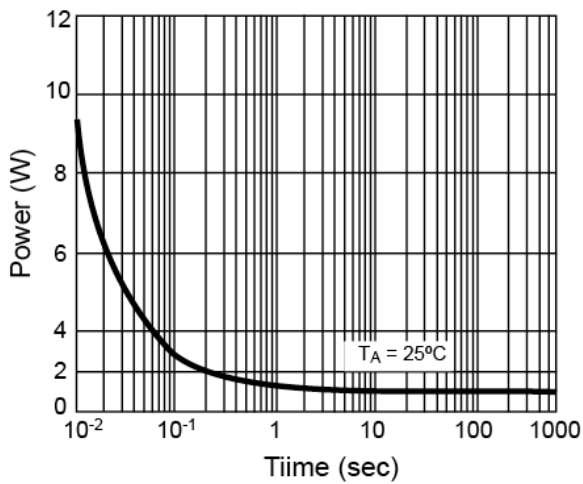

Normalized Thermal Transient Impedance, Junction-to-Ambient

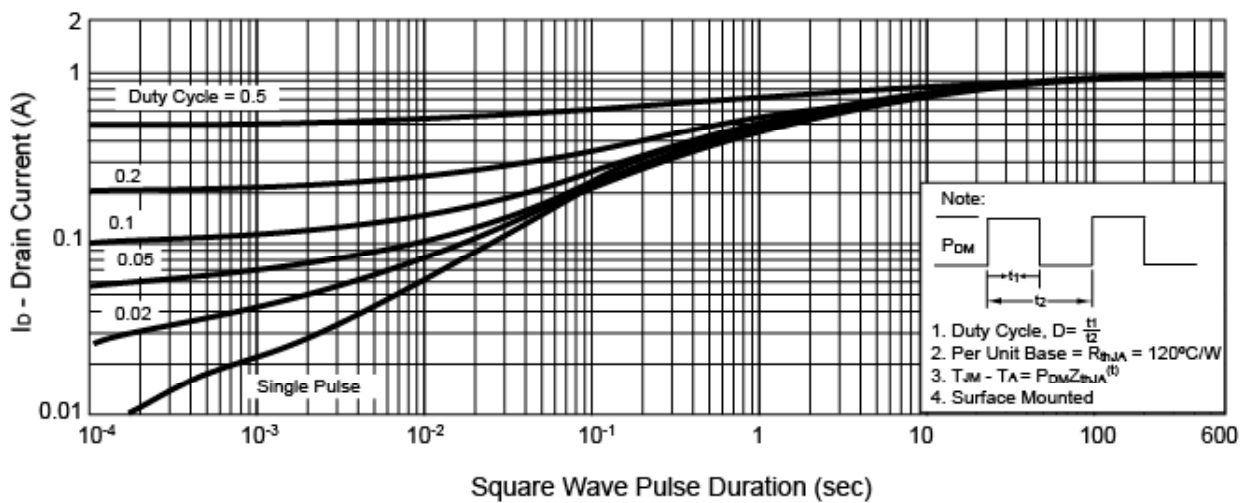

SCHOTTKY Electrical Characteristics Curve (Ta = 25°C, unless otherwise noted)

Typical Forward Current Derating Curve

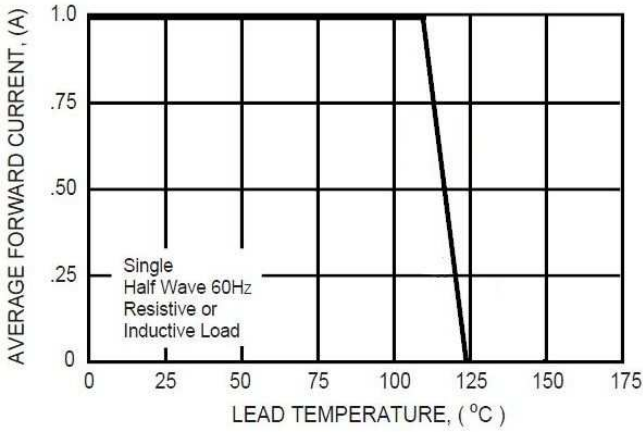

Typical Instantaneous Forward Characteristics

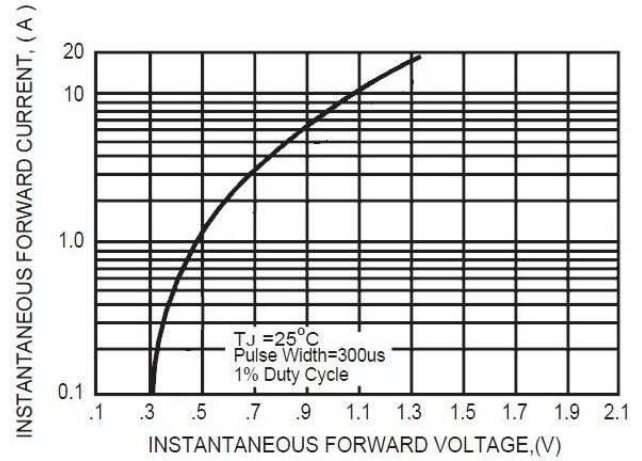

Typical Reverse Characteristics

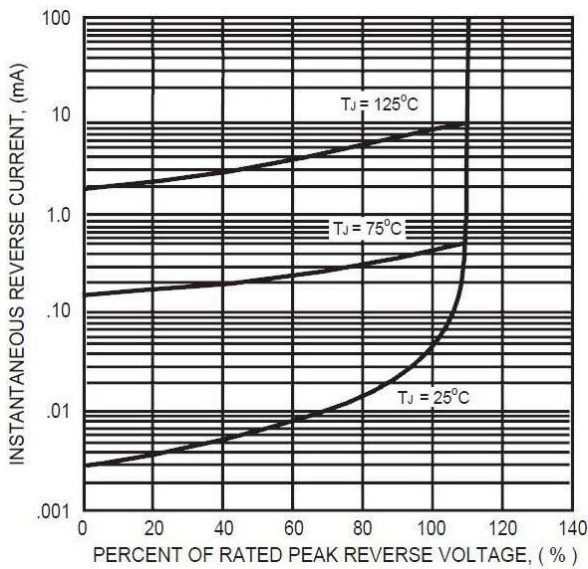

Typical Junction Capacitance

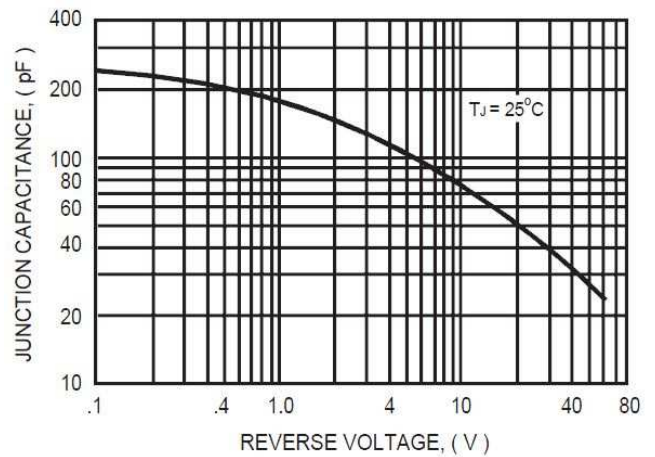

Maximum Repetitive Forward Surge Current

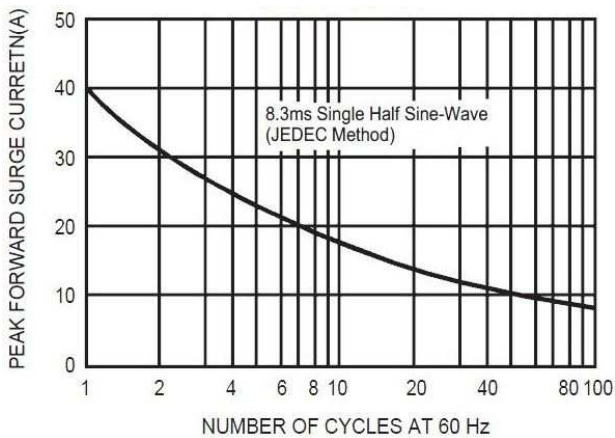

TDFN 2x2 Mechanical Drawing

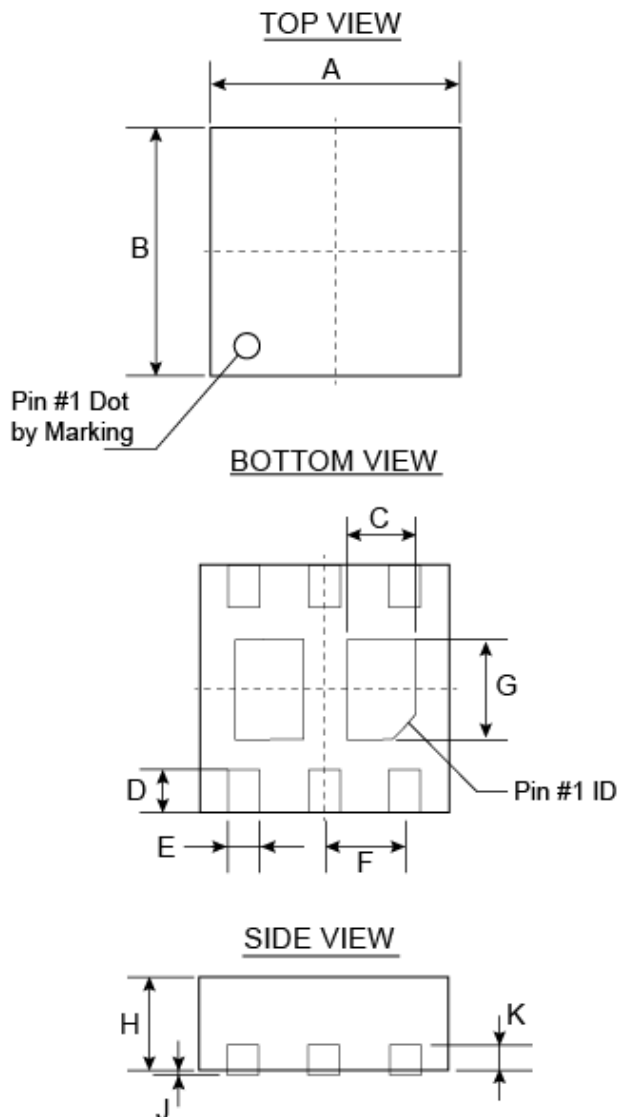

DIM	MILLIMETERS		INCHES	
	MIN	MAX	MIN	MAX
A	1.95	2.05	0.0768	0.0807
B	1.95	2.05	0.0768	0.0807
C	0.50	0.60	0.0197	0.0236
D	0.30	0.40	0.0118	0.0157
E	0.20	0.30	0.0079	0.0118
F	0.65 BSC		0.0256 BSC	
G	0.75	0.85	0.0295	0.0335
H	0.70	0.80	0.0276	0.0315
J	--	0.05	-	0.0020
K	0.195	0.211	0.0077	0.0083

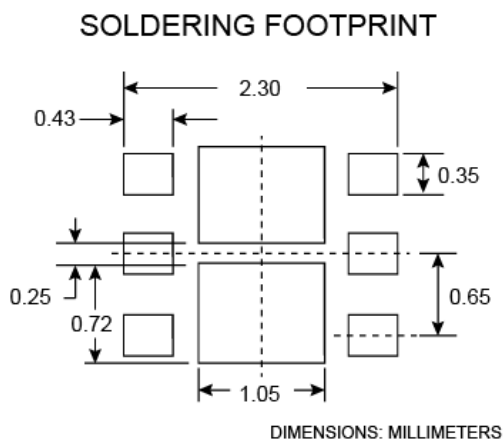

Marking Diagram

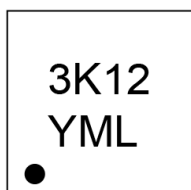

- Y** = Year Code
- M** = Month Code for Halogen Free Product
(**O**=Jan, **P**=Feb, **Q**=Mar, **R**=Apr, **S**=May, **T**=Jun, **U**=Jul, **V**=Aug, **W**=Sep, **X**=Oct, **Y**=Nov, **Z**=Dec)
- L** = Lot Code

Notice

Specifications of the products displayed herein are subject to change without notice. TSC or anyone on its behalf, assumes no responsibility or liability for any errors or inaccuracies.

Information contained herein is intended to provide a product description only. No license, express or implied, to any intellectual property rights is granted by this document. Except as provided in TSC's terms and conditions of sale for such products, TSC assumes no liability whatsoever, and disclaims any express or implied warranty, relating to sale and/or use of TSC products including liability or warranties relating to fitness for a particular purpose, merchantability, or infringement of any patent, copyright, or other intellectual property right.

The products shown herein are not designed for use in medical, life-saving, or life-sustaining applications. Customers using or selling these products for use in such applications do so at their own risk and agree to fully indemnify TSC for any damages resulting from such improper use or sale.