

# Cellular 2G/3G/GSM + LPWA NB-IoT/LoRA/SigFox - Board Antenna



**PRO-IS-589**

Request Samples



Check Inventory



75.0 x 8.0 x 0.8mm  
RoHS/RoHS II Compliant  
MSL Level = 1

## Features

- Compact
- Thickness of 0.8 mm
- Linear Polarization
- Gain of 4.1 dBi
- Efficiency > 66% (Lower Band), 26% (Upper Band)
- Easy integration using cable and connector
- Customizable cable and Connector options

## Applications

- Cellular 2G/3G/GSM and NB-IoT applications
- IoT/ M2M
- Automation/ Smart Home
- Healthcare Devices
- Hand-free/ PC Peripherals
- Remote monitoring/ Video and surveillance

## Product Image



# Cellular 2G/3G/GSM + LPWA NB-IoT/LoRA/SigFox - Board Antenna



**PRO-IS-589**

Request Samples



Check Inventory



**75.0 x 8.0 x 0.8mm**  
**RoHS/RoHS II Compliant**  
**MSL Level = 1**

## Electrical Specification

Parameter	Specification		Unit
Operating Frequency	791 ~ 960	1710 ~ 1990	MHz
Return Loss	< -7.7	< -4.5	dB
Polarization	Linear		
Peak Gain	4.1	2.8	dBi
Efficiency	>66	>26	%
Impedance	50	50	$\Omega$

## Mechanical Specification

Parameter	Specification
Antenna Dimension	75 x 8 x 0.8 mm
Cable Type	Coaxial
Cable length	64 mm
Connector Type	MHF-4 (F)
Mounting Type	Adhesive

## Environmental Specification

Parameter	Specification
Operating Temperature	-40°C to +85°C
MSL Level	1
RoHS/RoHS II Compliant	Yes



5101 Hidden Creek Ln Spicewood TX 78669  
 Phone: 512-371-6159 | Fax: 512-351-8858  
 For terms and conditions of sales, please visit:  
[www.abracon.com](http://www.abracon.com)

**REVISED: 11-22-21**

ABRACON IS  
 ISO9001-2015  
 CERTIFIED



**PRO-IS-589**

Request Samples



Check Inventory



75.0 x 8.0 x 0.8mm  
RoHS/RoHS II Compliant  
MSL Level = 1

## Product Dimensions

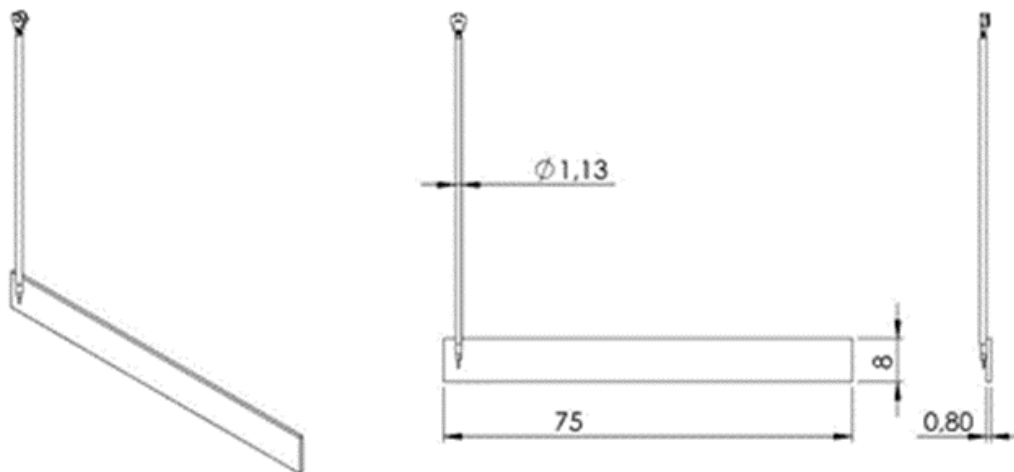

Unit: mm

## Measurement Setup

The antenna measurements were done on a standard measurement fixture - the antenna mounted in an ABS plastic box, 150x150x45 mm, connected to a PCB, 120x50 mm, with the cable fully extended

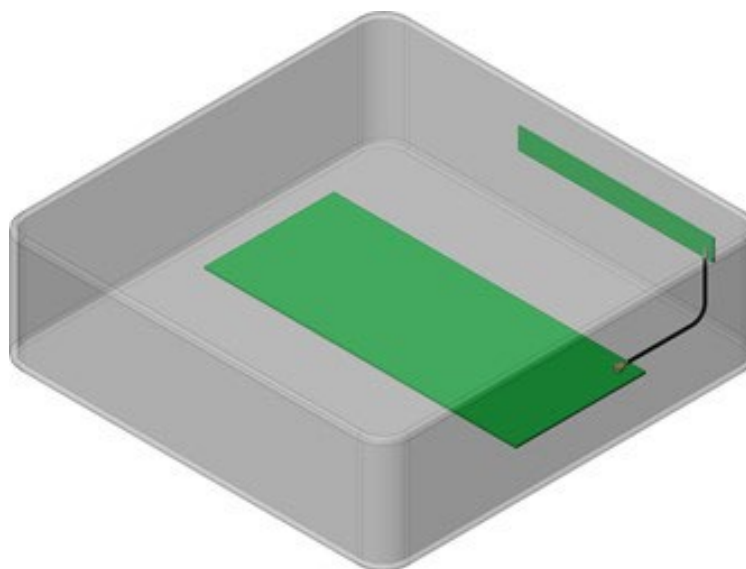



**PRO-IS-589**

Request Samples



Check Inventory



**75.0 x 8.0 x 0.8mm**  
**RoHS/RoHS II Compliant**  
**MSL Level = 1**

## Return Loss

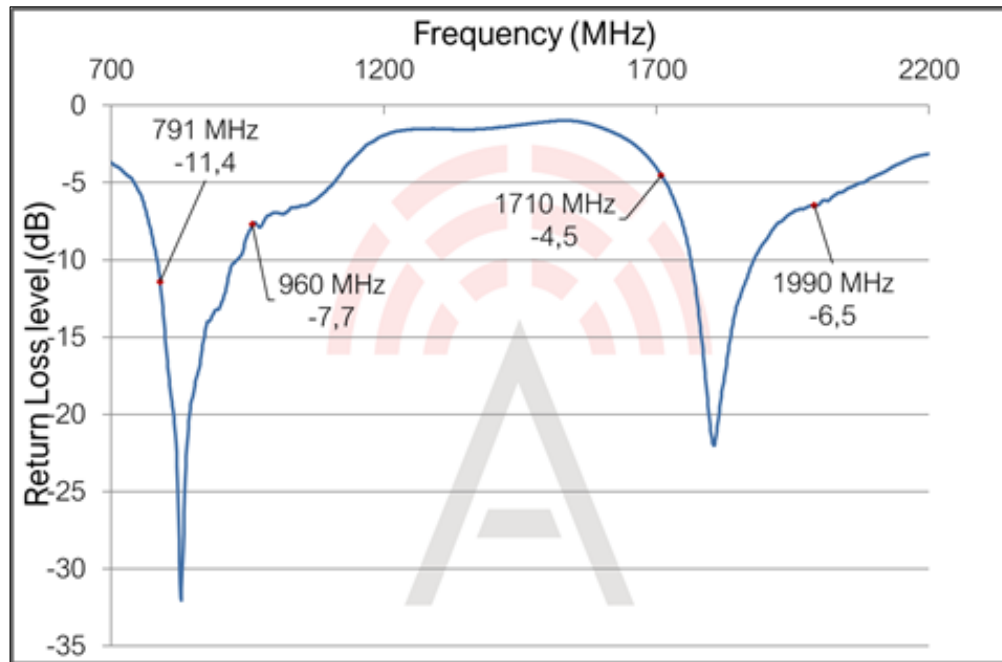

## Total Radiation Efficiency

## Maximum Radiation Gain

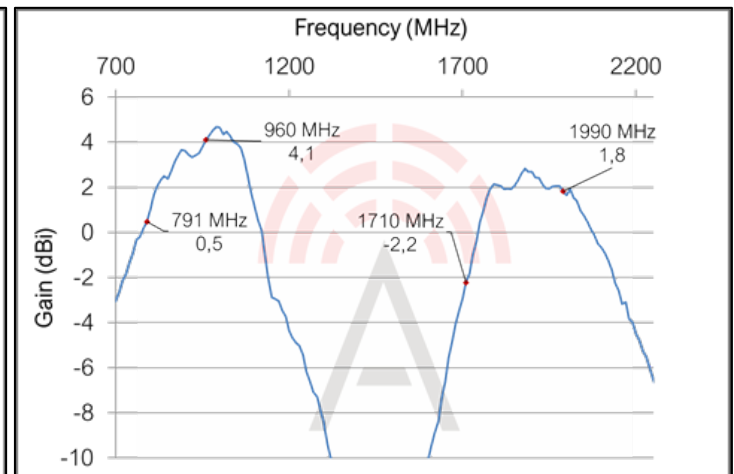
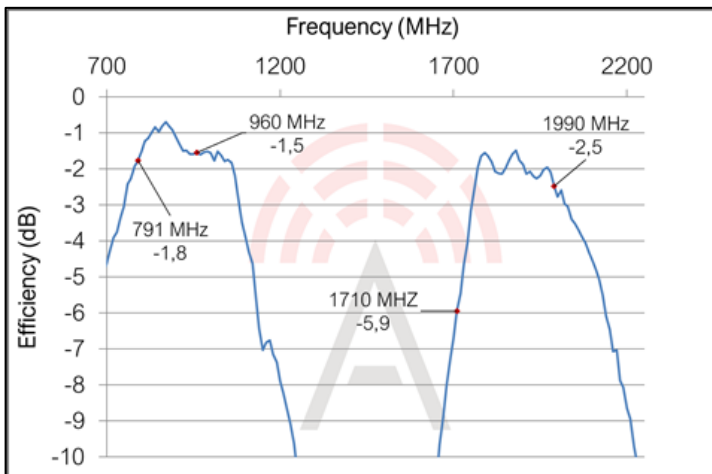



**PRO-IS-589**

Request Samples



Check Inventory



75.0 x 8.0 x 0.8mm  
RoHS/RoHS II Compliant  
MSL Level = 1

## Radiation Characteristics - 2D Pattern (870 MHz)

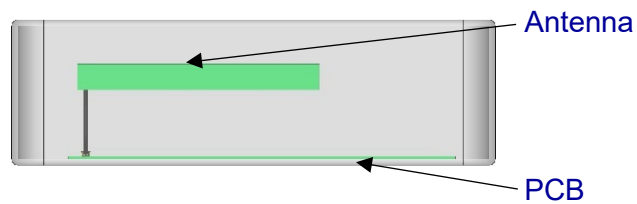
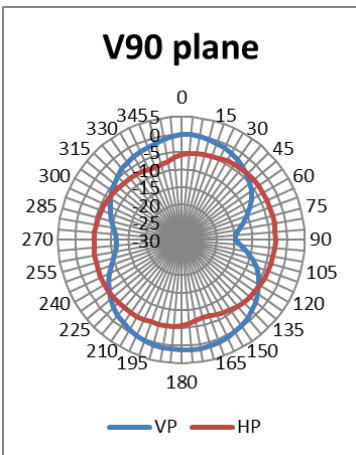
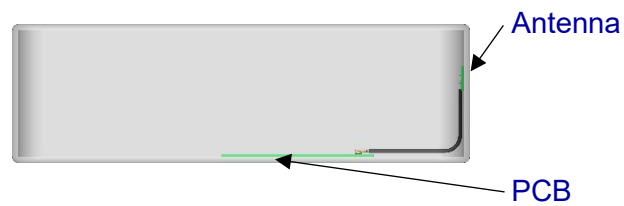
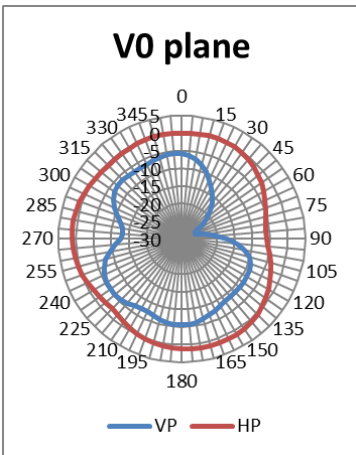
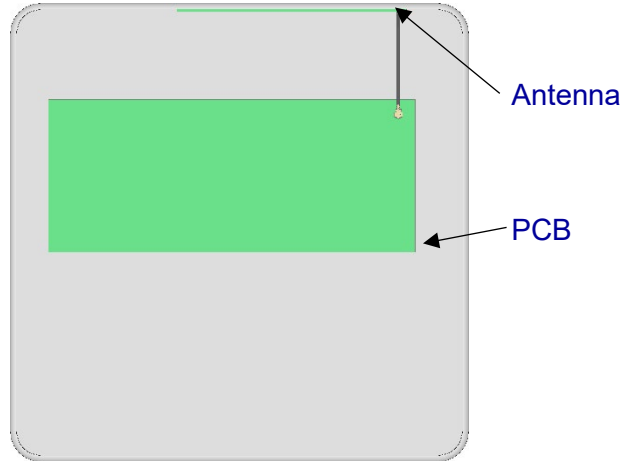
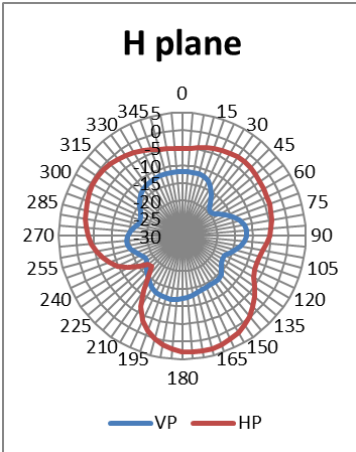



**PRO-IS-589**

Request Samples



Check Inventory



**75.0 x 8.0 x 0.8mm**  
**RoHS/RoHS II Compliant**  
**MSL Level = 1**

## Radiation Characteristics - 2D Pattern (1850 MHz)

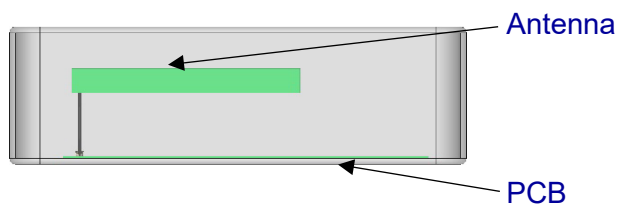
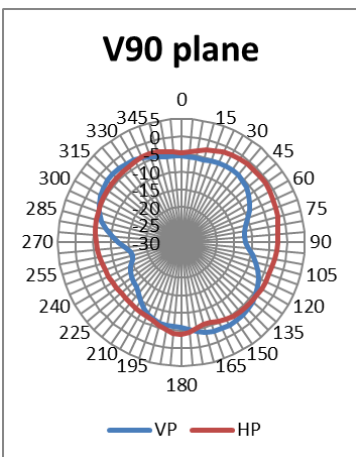
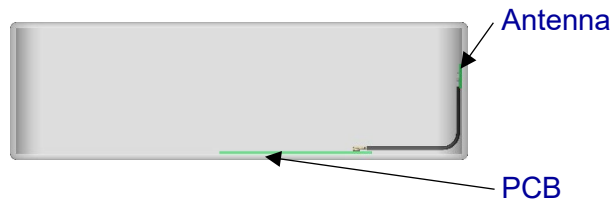
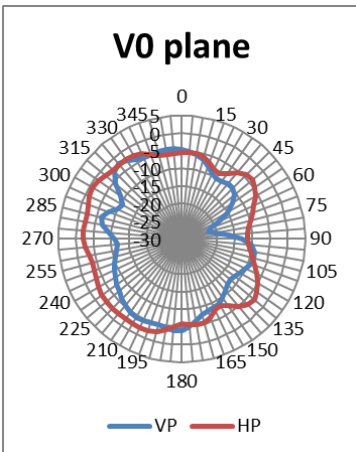
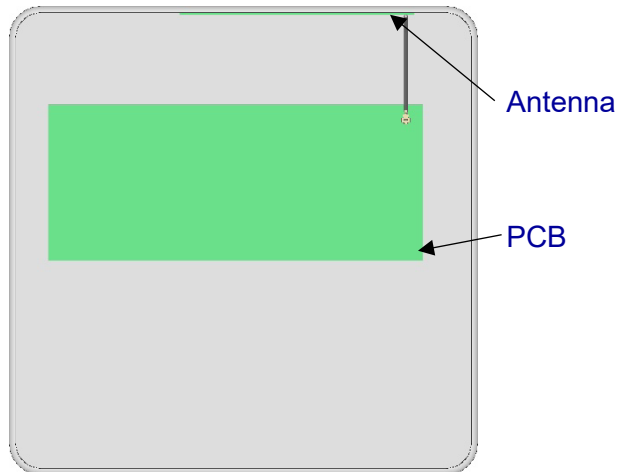
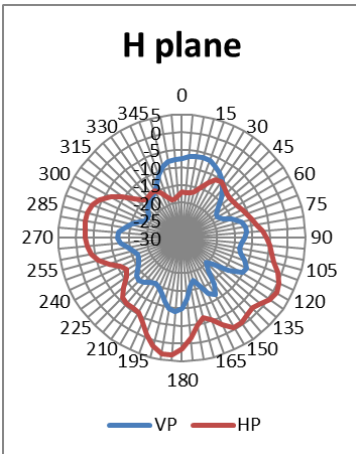

# Cellular 2G/3G/GSM + LPWA NB-IoT/LoRA/SigFox - Board Antenna



**PRO-IS-589**

Request Samples



Check Inventory



**75.0 x 8.0 x 0.8mm**  
**RoHS/RoHS II Compliant**  
**MSL Level = 1**

## Packaging Information

---

Pieces per bag: 100 pieces

**ATTENTION:** Abracon LLC's products are COTS – Commercial-Off-The-Shelf products; suitable for Commercial, Industrial and, where designated, Automotive Applications. Abracon's products are not specifically designed for Military, Aviation, Aerospace, Life-dependent Medical applications or any application requiring high reliability where component failure could result in loss of life and/or property. For applications requiring high reliability and/or presenting an extreme operating environment, written consent and authorization from Abracon LLC is required. Please contact Abracon LLC for more information.



5101 Hidden Creek Ln Spicewood TX 78669  
Phone: 512-371-6159 | Fax: 512-351-8858  
For terms and conditions of sales, please visit:  
[www.abracon.com](http://www.abracon.com)

**REVISED: 11-22-21**

ABRACON IS  
ISO9001-2015  
CERTIFIED