



SPECIFICATION SHEET

SPECIFICATION SHEET NO.	N0310-SMAUS1M000S10A
DATE	Mar. 10, 2021
REVISION	A0
DESCRIPTION	<p>SMD High Efficiency Rectifier, 2 Pads, SMA series, US1M Type</p> <p>Reverse Voltage 1000V Max. Forward Current 1.0A Max.</p> <p>Operating Temp. Range -50°C ~+150°C</p> <p>Package in Tape/Reel, 2000pcs/Reel</p> <p>RoHS/RoHS III compliant</p>
CUSTOMER	
CUSTOMER PART NUMBER	
CROSS REF. PART NUMBER	
ORIGINAL PART NUMBER	MDD US1M
PART CODE	SMAUS1M000S10A

VENDOR APPROVE			
Issued/Checked/Approved			
DATE: March 10, 2021			

CUSTOMER APPROVE
DATE:

SMD HIGH EFFICIENCY RECTIFIER SMA SERIES

MAIN FEATURE

- The plastic package carries Underwriters Laboratory Flammability Classification 94V-0
- Low reverse leakage
- Built-in strain relief,
- High forward surge current capability
- Ultra fast switching for high efficiency
- High temperature soldering guaranteed: 250°C/ 10 seconds at terminals



APPLICATION

- For printed circuit board

RFQ

[Request For Quotation](#)

PART CODE GUIDE

SMA	US1M000	S	10A
1	2	3	4

- 1) **SMA**: SMD High Efficiency Rectifier, 2 Pads, SMA series
- 2) **US1M000**: Type code for original part number US1M
- 3) **S**: Package code, Tape/reel, 2000pcs/reel.
- 4) **10A**: Specification code for Reverse Voltage 1000V Max. Forward Current 1.0A Max.

MORE ITEMS AVAILABLE

SMAUS1A000S105	SMAUS1B000S110	SMAUS1D000S120	SMAUS1G000S140	SMAUS1J000S160
SMAUS1K000S180	SMAUS1M000S10A			
SMAUS2A000S205	SMAUS2B000S210	SMAUS2D000S220	SMAUS2G000S240	SMAUS2J000S260
SMAUS2K000S280	SMAUS2M000S20A			

SMD HIGH EFFICIENCY RECTIFIER SMA SERIES

DIMENSION (Unit: Inch/mm)

Image for reference



Marking: US1M

SMA/DO-214AC

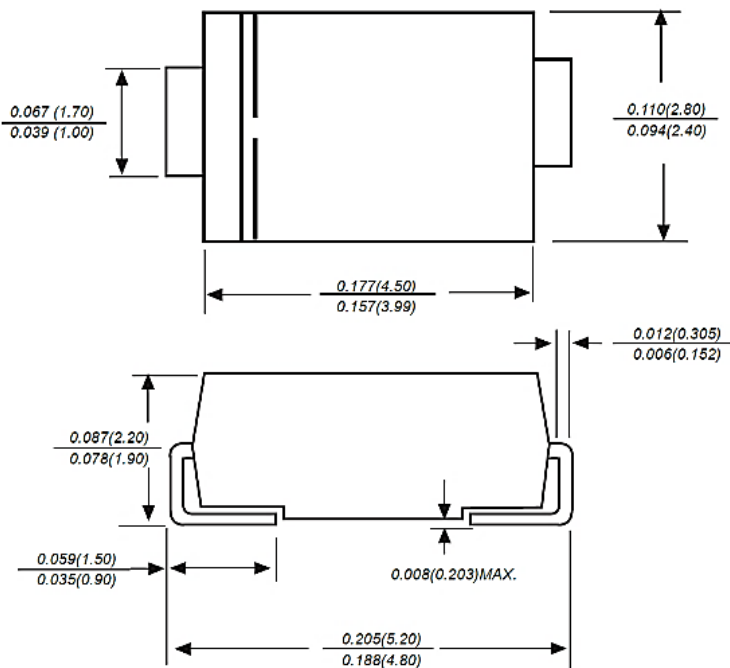

Recommend Pad Layout

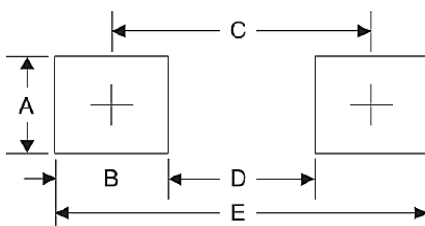

Symbol	Unit (Inch)	Unit (mm)
A	0.066	1.680
B	0.060	1.520
C	0.154	3.900
D	0.095	2.410
E	0.215	5.450

SMD HIGH EFFICIENCY RECTIFIER SMA SERIES
MECHANICAL DATA

Case	Terminals	Polarity	Mounting Position	Weight per piece
JEDEC SMA/DO-214AC molded plastic body	Solder plated, Solderable per MIL-STD-750, Method 2026	Polarity symbol marking on case	Any	0.0020 Ounce, 0.0567 grams

MAX. RATING & CHARACTERISTICS

Parameter	SYMBOLS	VALUE			UNITS
		Min.	Typical	Max.	
Repetitive peak reverse voltage	V _{RRM}			1000	Volts
RMS voltage	V _{RMS}			700	Volts
DC blocking voltage	V _{DC}			1000	Volts
Average forward output rectified current at TL= 55°C	I _{AV}			1.0	A
Peak forward surge current 8.3ms single half sine-wave superimposed on rated load (JEDEC Method)	I _{FSM}		30		A
Instantaneous forward voltage at 1.0A	V _F			1.70	Volts
DC reverse current at rated DC blocking voltage	I _R			5	μA
				50	μA
Reverse recovery time (NOTE 2)	T _{rr}			75	ns
Junction capacitance (Note 3)	C _J		15		pF
Thermal resistance (Note 4)	R _{QJA}		50		°C/W
Operating junction temperature range	T _J	-55		+150	°C
Storage temperature range	T _{STG}	-55		+150	°C

Note

- Ratings at 25 C ambient temperature unless otherwise specified. Single phase half-wave 60Hz, resistive or inductive load, for capacitive load current derate by 20%.
- Reverse recovery condition IF=0.5A,IR=1.0A,Irr=0.25A
- Measured at 1.0MHz and applied reverse voltage of 4.0Voltage
- P.C.B. mounted with 0.2x0.2"(5.0x5.0mm) copper pad areas.

SMD HIGH EFFICIENCY RECTIFIER SMA SERIES

RELIABILITY

Number	Experiment Items	Experiment Method And Conditions	Reference Documents
1	Solder Resistance Test	Test 260°C± 5°C for 10 ± 2 sec. Immerse body into solder 1/16" ± 1/32"	MIL-STD-750D METHOD-2031.2
2	Solderability Test	230°C ±5°C for 5 sec.	MIL-STD-750D METHOD-2026.1 0
3	Pull Test	1 kg in axial lead direction for 10 sec.	MIL-STD-750D METHOD-2036.4
4	Bend Test	0.5Kg Weight Applied To Each Lead, Bending Arcs 90 °C ± 5 °C For 3 Times	MIL-STD-750D METHOD-2036.4
5	High Temperature Reverse Bias Test	TA=100°C for 1000 Hours at VR=80% Rated VR	MIL-STD-750D METHOD-1038.4
6	Forward Operation Life Test	TA=25°C Rated Average Rectified Current	MIL-STD-750D METHOD-1027.3
7	Intermittent Operation Life Test	On state: 5 min with rated IRMS Power Off state: 5 min with Cool Forced Air. On and off for 1000 cycles.	MIL-STD-750D METHOD-1036.3
8	Pressure Cooker Test	15 PSIG, TA=121°C, 4 hours	MIL-S-19500 APPENOIXC
9	Temperature Cycling Test	-55°C~+125°C; 30 Minutes For Dwelled Time 5 minutes for transferred time. Total: 10 cycles.	MIL-STD-750D METHOD-1051.7
10	Thermal Shock Test	0°C for 5 minutes., 100°C for 5minutes, Total: 10 cycles	MIL-STD-750D METHOD-1056.7
11	Forward Surge Test	8.3ms Single Sale Sine-wave One Surge.	MIL-STD-750D METHOD-4066.4
12	Humidity Test	TA=65°C, RH=98% for 1000 hours.	MIL-STD-750D METHOD-1021.3
13	High Temperature Storage life Test	150°C for 1000 Hours	MIL-STD-750D METHOD-1031.5

SMD HIGH EFFICIENCY RECTIFIER SMA SERIES

SUGGESTED REFLOW PROFILE (For Reference Only)

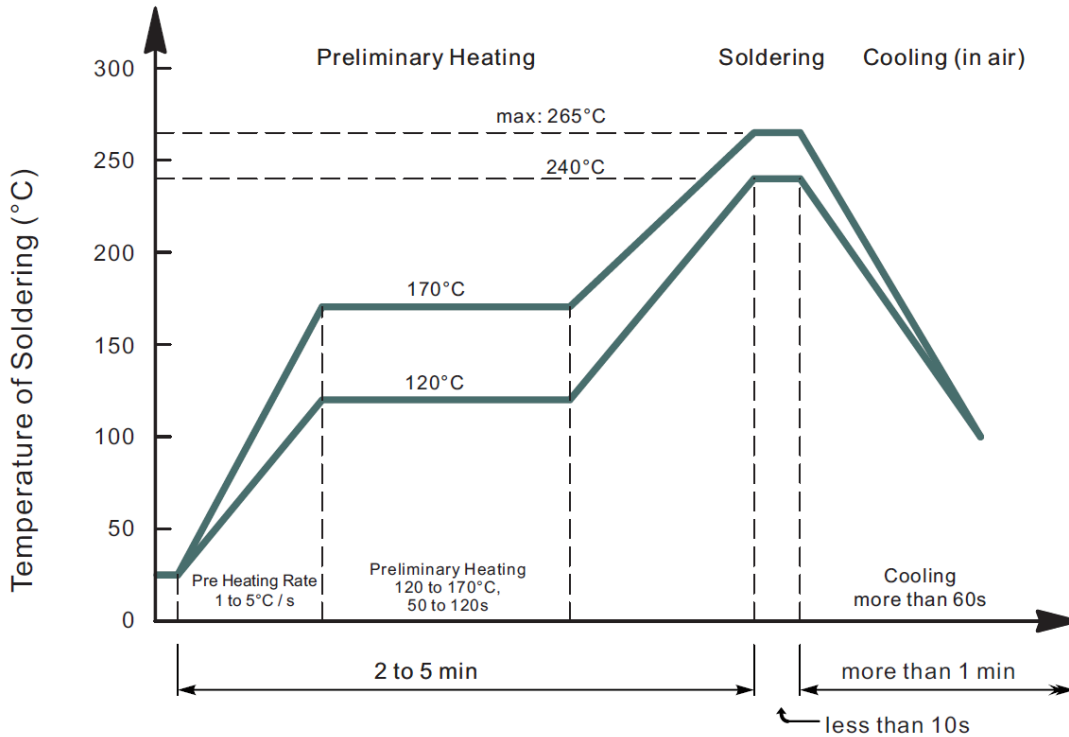

- Recommended peak temperature is over 245°C, If peak temperature is below 245 °C, you may adjust the following parameters; time length of peak temperature (longer), time length of soldering (longer), thickness of solder paste (thicker)
- Welding shall not exceed 2 times
- Remark: lead free solder paste (96.5 sn/3.0 Ag/0.5Cu)

SMD HIGH EFFICIENCY RECTIFIER SMA SERIES

RATINGS AND CHARACTERISTIC CURVES (For Reference Only)

AVERAGE FORWARD RECTIFIED CURRENT, AMPERES

FIG. 1- FORWARD CURRENT DERATING CURVE

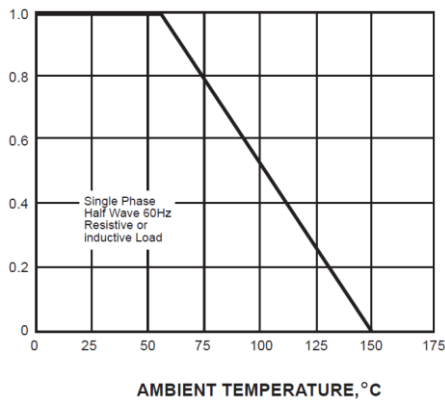

PEAK FORWARD SURGE CURRENT, AMPERES

FIG. 2-MAXIMUM NON-REPETITIVE PEAK FORWARD SURGE CURRENT

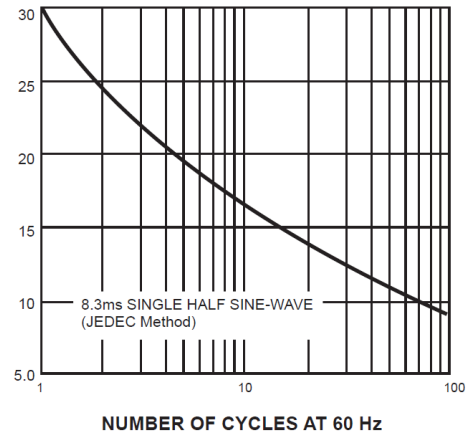

FIG. 3-TYPICAL INSTANTANEOUS FORWARD CHARACTERISTICS

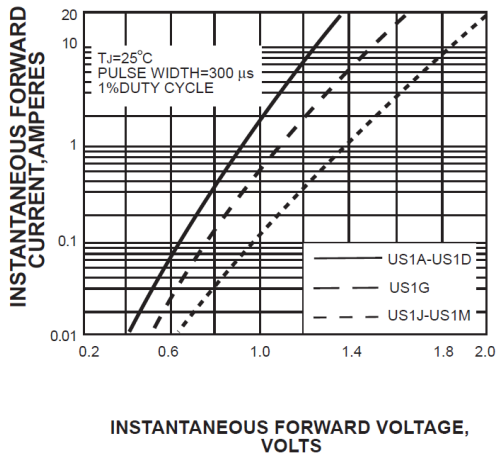

FIG. 4-TYPICAL REVERSE CHARACTERISTICS

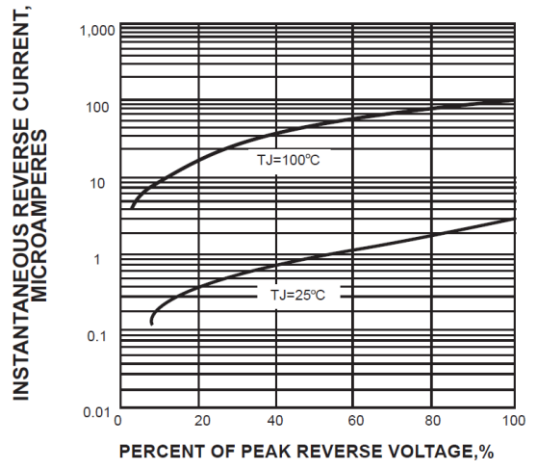

FIG. 5-TYPICAL JUNCTION CAPACITANCE

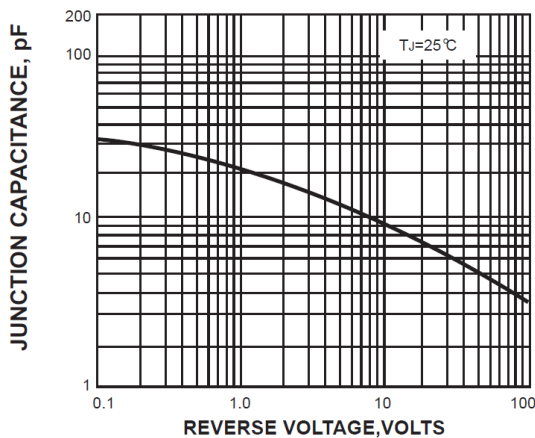
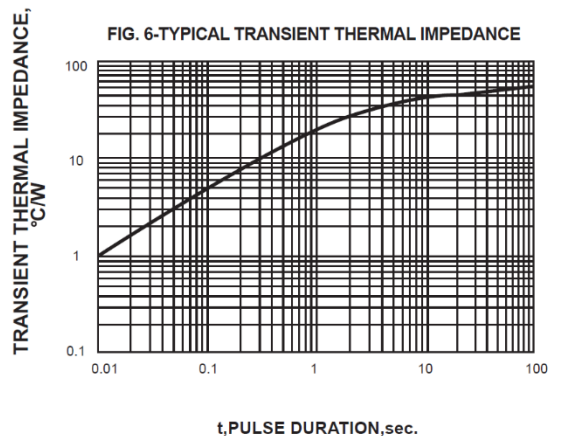

FIG. 6-TYPICAL TRANSIENT THERMAL IMPEDANCE



SMD HIGH EFFICIENCY RECTIFIER SMA SERIES

TAPE/REEL (Unit: mm)

All Devices are packed in accordance with EIA standard RS-481-A and specifications.

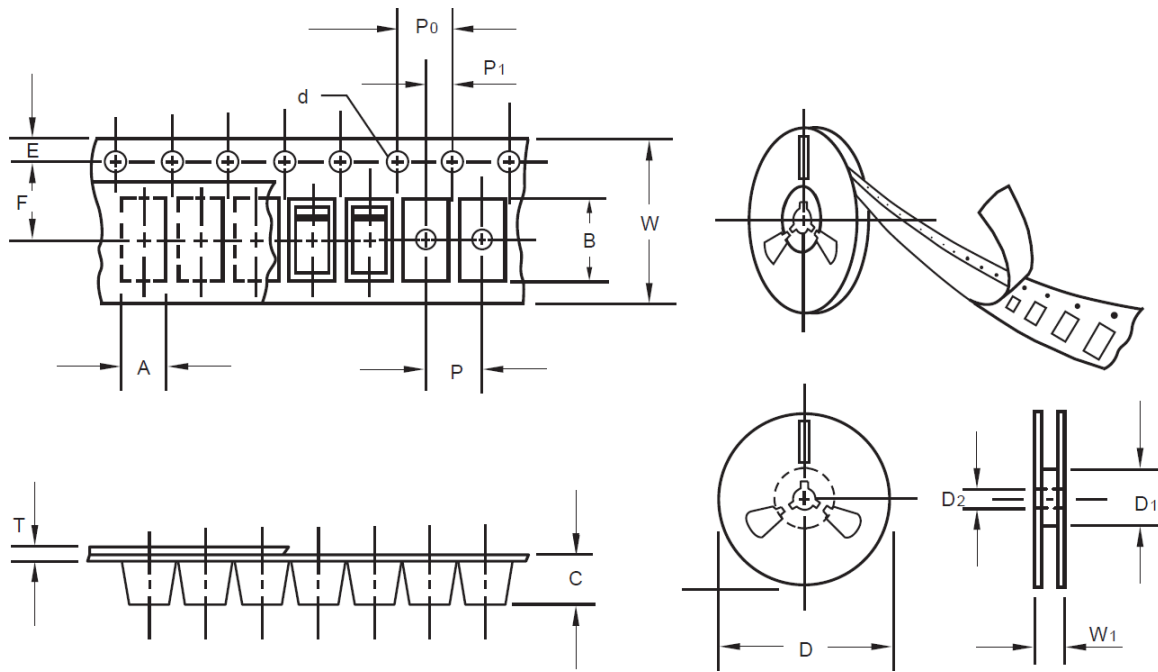

Item	Symbol	Tolerance	SMA/DO-214AC
Carrier width	A	0.1	2.8
Carrier Length	B	0.1	5.33
Carrier Depth	C	0.1	2.36
Sprocket hole	d	0.05	1.50
13" Reel outside diameter	D	-	-
13" Reel inner diameter	D1	-	-
7" Reel outside diameter	D	2.0	178.00
7" Reel inner diameter	D1	Min.	62.00
Feed hole diameter	D2	0.5	13.00
Sprocket hole position	E	0.1	1.75
Punch hole position	F	0.1	5.50
Punch hole pitch	P	0.1	4.00
Sprocket hole pitch	P0	0.1	4.00
Embossment center	P1	0.1	2.0
Overall tape thickness	T	0.1	0.28
Tape width	W	0.3	12.00
Reel width	W1	1.0	18.0

SMD HIGH EFFICIENCY RECTIFIER SMA SERIES

PACKAGE

Case Code	Reel Size	MPQ (pcs)	Component Spacing (mm)	Qty. Per Box (pcs)	Inner Box L*W*H (mm)	Reel Size (mm)	Carton size L*W*H (mm)	Qty. Per Carton (pcs)	G. W (kg)
SMA	7"	2,000		4,000	183*155*183	178	370*370*380	80,000	11.0

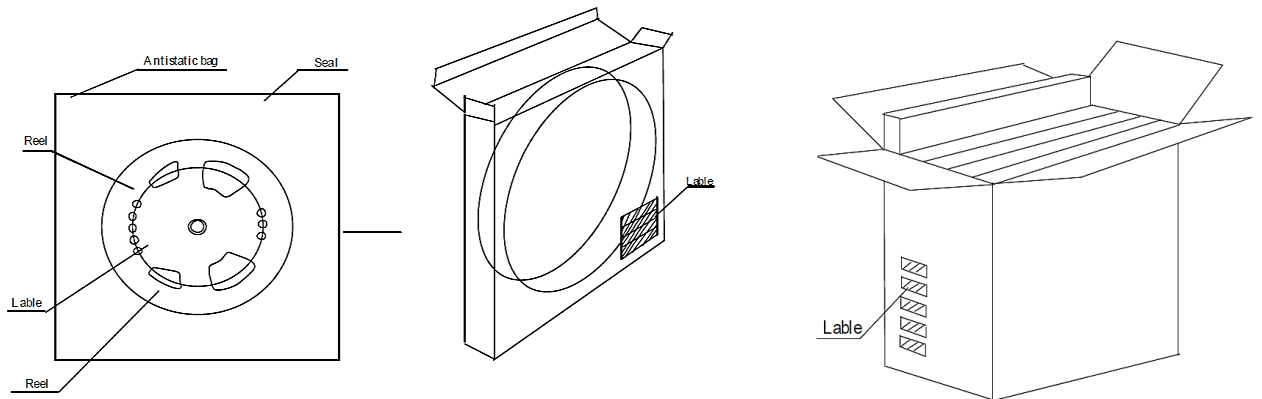

DISCLAIMER

NextGen Component, Inc. reserves the right to make changes to the product(s) and or information contained herein without notice. No liability is assumed as a result of their use or application. No rights under any patent accompany the sale of any such product(s) or information