

1 A, 10 mA, 4-triggering quadrant Triac in SO-8

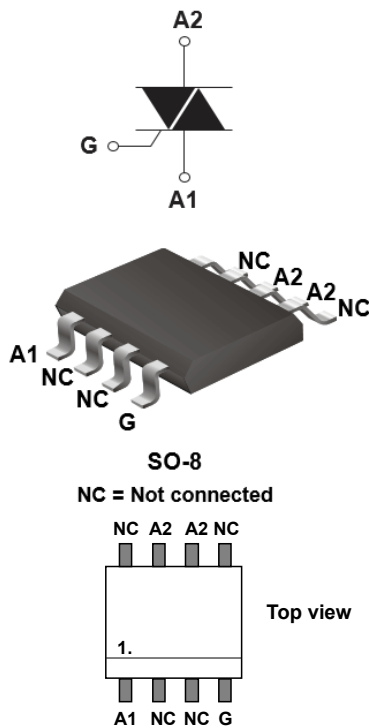

Product status link

[Z0109M1](#)

Product summary

$I_{T(RMS)}$	1 A
V_{DRM}/V_{RRM}	600 V
V_{DSM}/V_{RSM}	700 V
I_{GT}	10 mA

Features

- Low current Triac, $I_{T(RMS)} = 1$ A
- Logic level 4-triggering quadrants
- SMD package with 4.9×6 mm² total size
- 4 mm A1-A2 creepage distance compatible with IEC 60664-1 pollution degree 3 at 250 V, overvoltage category 2, material group 3a and 3b
- ECOPACK2 compliant component
- Dual footprint compatible with SO-8 and SOT-223

Applications

- General purpose AC line load switching
- Actuator AC drive circuit such as electro-valve, dispenser, pump, fan
- LED / lamps control
- High voltage solenoid drive circuit such as breaker interrupter and relay
- Major and small home appliances
- Home and industrial automation systems

Description

The Z0109M1 Triac, housed in SO-8 surface mount package, enables compact power control designs compatible with automated assembly lines.

This device achieves an on/off and phase angle control where low triggering energy is required.

It can be controlled directly from a microcontroller and is able to drive resistive or inductive low current AC loads.

Table 1. Table pin name

Symbol	Type	Description	Pin
G	Drive	Gate	4
A1	Power	Anode1	1
A2	Power	Anode2	6, 7
NC		Not connected	2,3,5,8

1 Characteristics

Table 2. Absolute maximum ratings (limiting values, $T_j = 25\text{ °C}$ unless otherwise stated)

Symbol	Parameters		Value	Unit	
$I_{T(RMS)}$	RMS on-state current (full sine wave)	SO-8	$T_{LEAD} = 90\text{ °C}$	1	A
I_{TSM}	Non repetitive surge peak on-state current (full cycle, T_j initial = 25 °C)	$f = 50\text{ Hz}$	$t_p = 20\text{ ms}$	8	A
		$f = 60\text{ Hz}$	$t_p = 16.7\text{ ms}$	8.5	
I^2t	I^2t value for fusing	$t_p = 10\text{ ms}$		0.35	A^2s
V_{DRM}/V_{RRM}	Repetitive peak off-state voltage		$T_j = 125\text{ °C}$	600	V
V_{DSM}/V_{RSM}	Non Repetitive peak off-state voltage	$t_p = 10\text{ ms}$	$T_j = 25\text{ °C}$	700	V
di/dt	Critical rate of rise of on-state current $I_G = 2 \times I_{GT}$, $t_r \leq 100\text{ ns}$	$f = 120\text{ Hz}$	$T_j = 25\text{ °C}$	50	$A/\mu s$
I_{GM}	Peak gate current	$t_p = 20\text{ }\mu s$	$T_j = 125\text{ °C}$	1	A
$P_{G(AV)}$	Average gate power dissipation		$T_j = 125\text{ °C}$	0.1	W
T_{stg}	Storage junction temperature range			-40 to +150	$^{\circ}C$
T_j	Operating junction temperature range			-40 to +125	$^{\circ}C$

Table 3. Electrical characteristics ($T_j = 25\text{ °C}$, unless otherwise specified)

Symbol	Parameters	Quadrant		Value	Unit
$I_{GT}^{(1)}$	$V_D = 12\text{ V}$, $R_L = 30\text{ }\Omega$	I - II - III - IV	Max.	10	mA
V_{GT}			Max.	1.3	
V_{GD}	$V_D = V_{DRM}$, $R_L = 3.3\text{ k}\Omega$, $T_j = 125\text{ °C}$	All	Min.	0.2	V
$I_H^{(2)}$	$I_T = 50\text{ mA}$		Max.	10	mA
I_L	$I_G = 1.2 I_{GT}$	I - III - IV	Max.	15	
		II	Max.	25	
$dV/dt^{(2)}$	$V_D = 67\% V_{DRM}$ gate open, $T_j = 110\text{ °C}$		Min.	50	$V/\mu s$
$(dV/dt)_c^{(2)}$	$(di/dt)_c = 0.44\text{ A/ms}$, $T_j = 110\text{ °C}$		Min.	2	$V/\mu s$

1. Minimum I_{GT} is guaranteed at 5% of I_{GT} max.
2. For both polarities of A2 referenced to A1

Table 4. Static electrical characteristics

Symbol	Test conditions	T_j		Value	Unit
$V_T^{(1)}$	$I_{TM} = 1.4\text{ A}$, $t_p = 380\text{ }\mu s$	25 °C	Max.	1.60	V
$V_{TO}^{(1)}$	Threshold on-state voltage	125 °C	Max.	0.95	V
$R_d^{(1)}$	Dynamic resistance	125 °C	Max.	0.43	Ω
I_{DRM} I_{RRM}	$V_D = V_R = V_{DRM} = V_{RRM}$	25 °C	Max.	5	μA
		125 °C		0.5	mA

1. For both polarities of A2 referenced to A1

Table 5. Thermal resistance

Symbol	Parameters		Value	Unit
$R_{th(j-l)}$	Junction to lead (AC), leads #6 and #7		19	°C/W
$R_{th(j-a)}$	Junction to ambient	Scu = 1 cm ²	140	
		Scu = minimum footprint	190	

1.1 Characteristics (curves)

Figure 1. Maximum power dissipation versus on-state RMS current (full cycle)

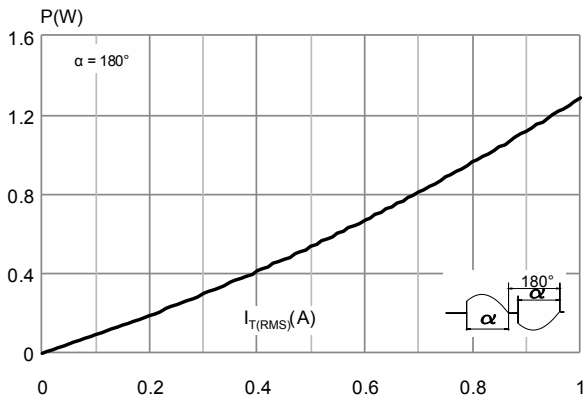

Figure 2. On-state RMS current versus lead pin# 6 and 7 temperature (full cycle)

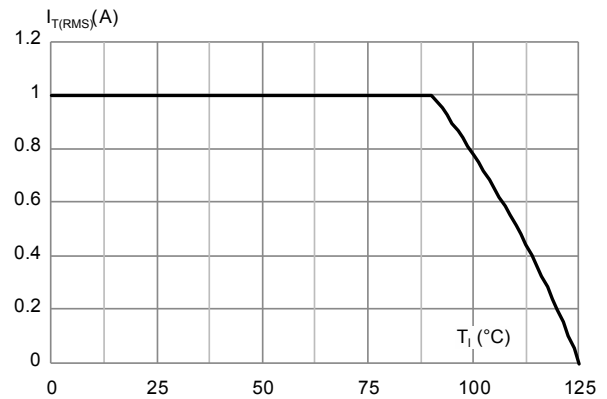

Figure 3. On-state RMS current versus ambient temperature (free air convection, full cycle)

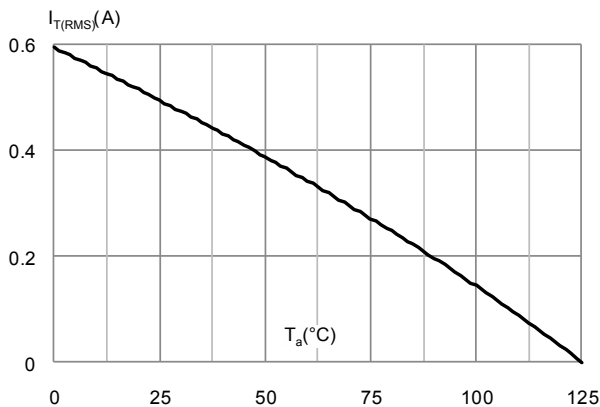

Figure 4. Relative variation of thermal impedance versus pulse duration

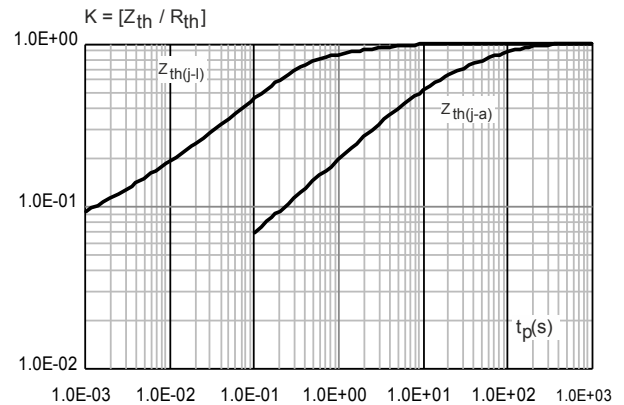

Figure 5. Surge peak on-state current versus number of cycles

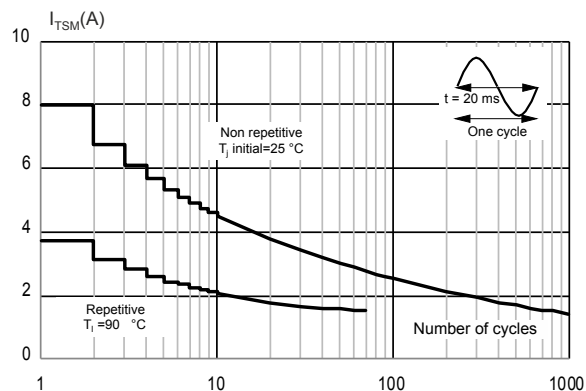

Figure 6. Non-repetitive surge peak on-state current for sinusoidal pulse with width $t_p < 10$ ms

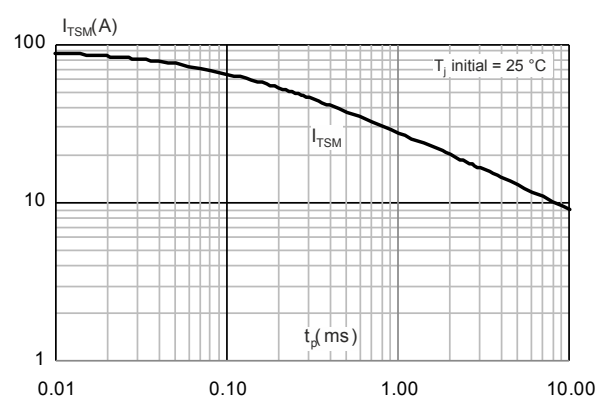

Figure 7. On-state characteristics (maximum values)

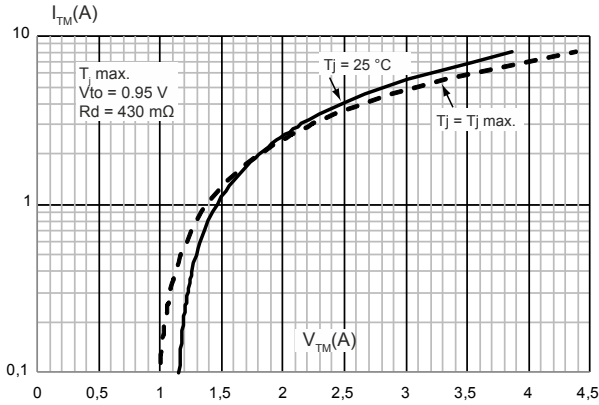

Figure 8. Relative variation of holding current and latching current versus junction temperature (typical values)

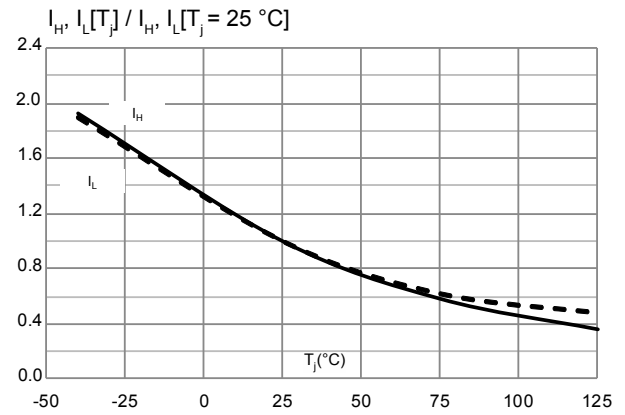

Figure 9. Relative variation of gate trigger current (I_{GT}) and voltage (V_{GT}) versus junction temperature (typical values)

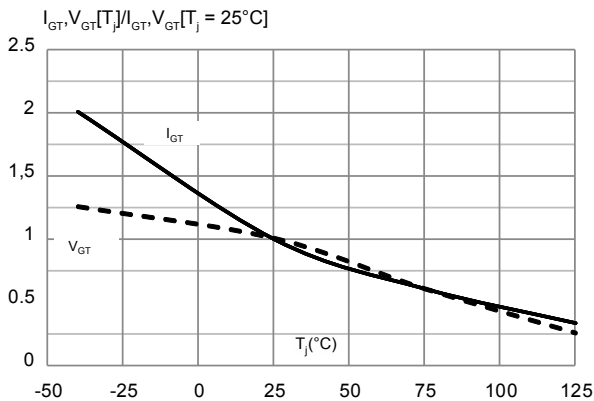

Figure 10. Relative variation of critical rate of decrease of main current (di/dt)c versus reapplied (dV/dt)c

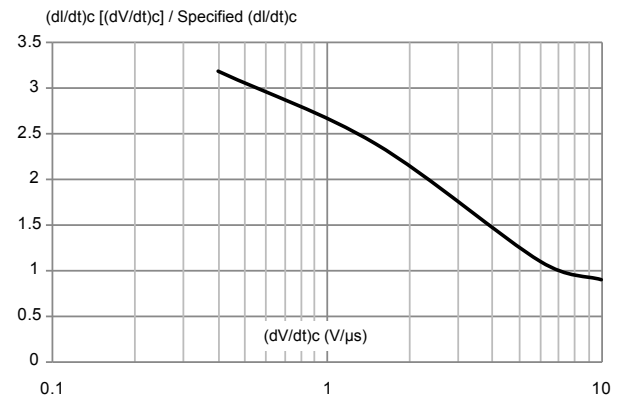

Figure 11. Relative variation of static dV/dt immunity versus junction temperature (typical values)

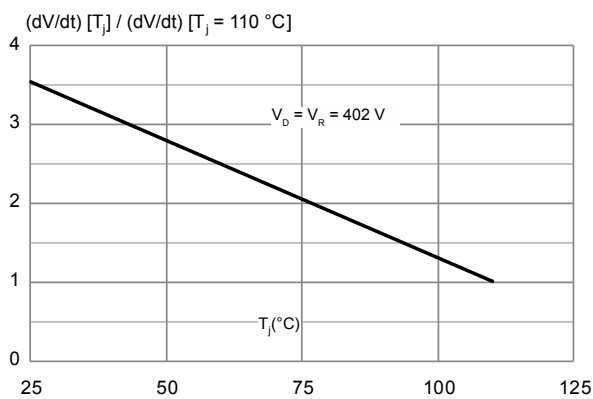

Figure 12. Relative variation of critical rate of decrease of main current (di/dt)c versus junction temperature

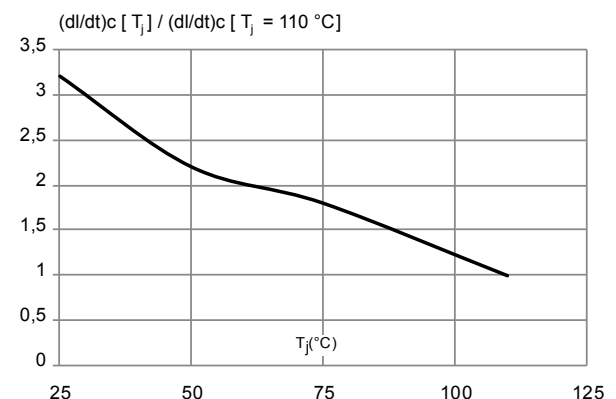

Figure 13. Relative variation of leakage current versus junction temperature

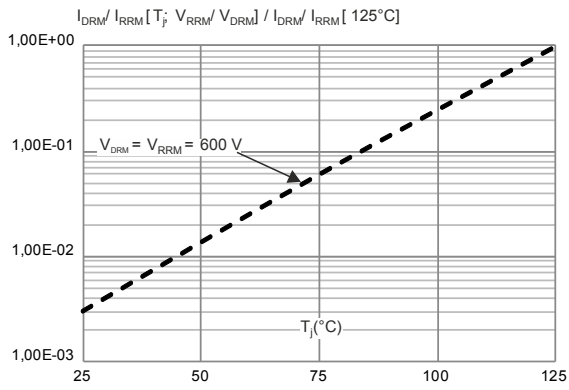
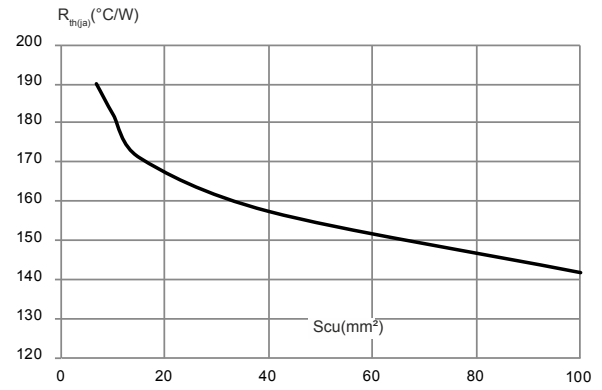

Figure 14. SO-8 Thermal resistance junction to ambient versus copper surface under pin 6 and 7



2 Package information

In order to meet environmental requirements, ST offers these devices in different grades of **ECOPACK** packages, depending on their level of environmental compliance. ECOPACK specifications, grade definitions and product status are available at: www.st.com. ECOPACK is an ST trademark.

2.1 SO-8 package information

Figure 15. SO8 package outline

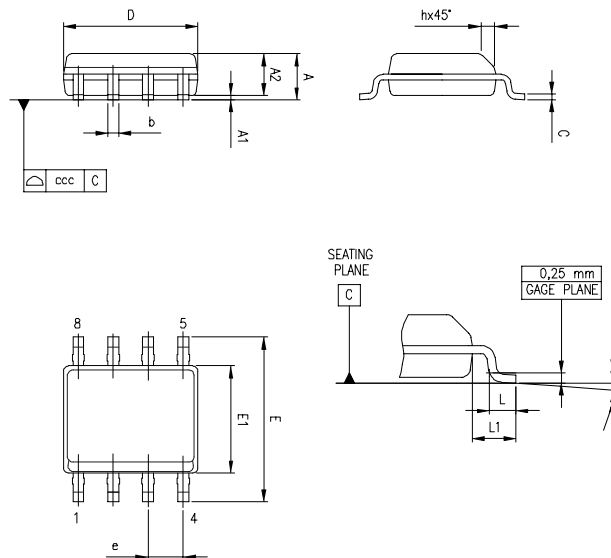

Table 6. SO-8 mechanical data

Symbol	Millimeters			Inches ⁽¹⁾		
	Min.	Typ.	Max.	Min.	Typ.	Max.
A			1.75			0.0680
A1	0.10		0.25	0.0030		0.0090
A2	1.25			0.0490		
b	0.28		0.48	0.0110		0.0180
c	0.17		0.23	0.0060		0.0090
D	4.80	4.90	5.00	0.1890	0.1920	0.1960
E	5.80	6.00	6.20	0.2280	0.2360	0.2440
E1	3.80	3.90	4.00	0.1490	0.1530	0.1570
e		1.27			0.0500	
h	0.25		0.50	0.0090		0.0190
L	0.40		1.27	0.0150		0.0500
L1		1.04			0.0400	
k	0°		8°	0°		8°
ccc			0.10			0.004

1. Values in inches are converted from mm and rounded to 4 decimal digits.

Figure 16. Recommended SO-8 Triac footprint in mm

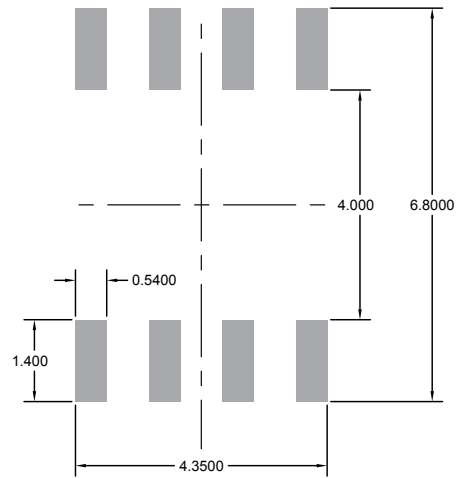
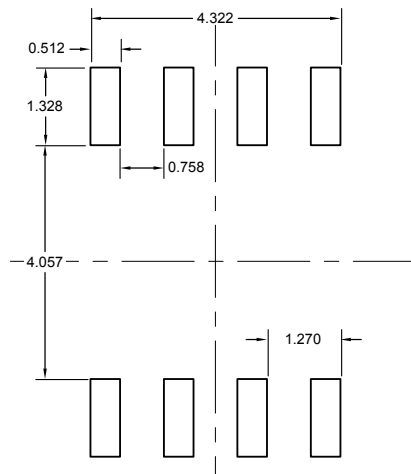

Table 7. Product pin assignment

Pin #	1	2	3	4	5	6	7	8
Assignment	A1	NC	NC	G	NC	A2	A2	NC
NC = Not connected								

Figure 17. SO-8 stencil definitions (dimensions are in mm)



3 Application recommendation

By using the following dual footprint your design will be compatible with both SO-8 and SOT-223 packages.

Figure 18. Recommended dual footprint in mm

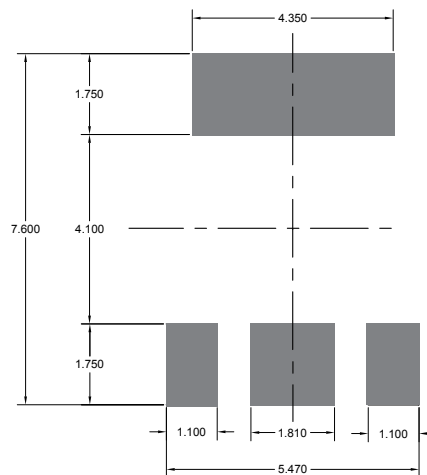

Figure 19. Recommended dual footprint in mm for compatibility with SO-8 and SOT-223 packages

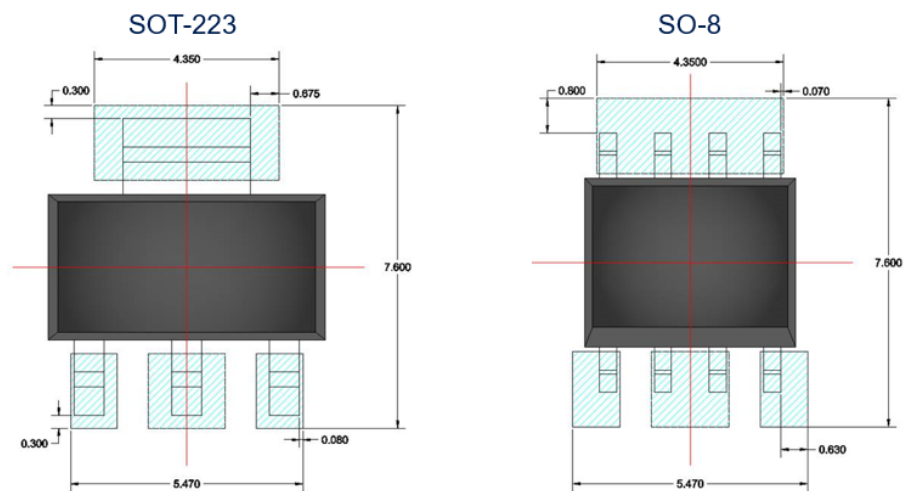
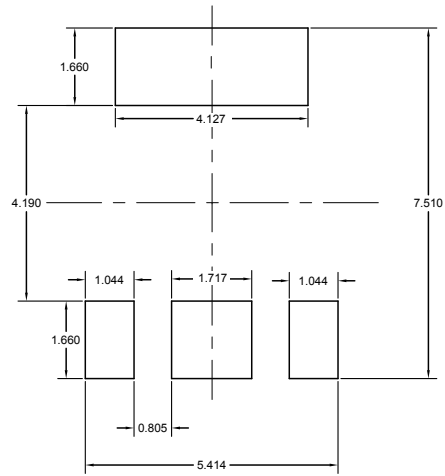

Figure 20. Dual footprint stencil definitions (dimensions are in mm)



4 Ordering information

Table 8. Ordering information

Order code	Marking	Package	Weight	Base qty.	Delivery mode
Z0109M1	Z0109M1	SO-8	0.1 g	2500	Tape and reel 13"

Revision history

Table 9. Document revision history

Date	Revision	Changes
15-Nov-2019	1	Initial release.

IMPORTANT NOTICE – PLEASE READ CAREFULLY

STMicroelectronics NV and its subsidiaries (“ST”) reserve the right to make changes, corrections, enhancements, modifications, and improvements to ST products and/or to this document at any time without notice. Purchasers should obtain the latest relevant information on ST products before placing orders. ST products are sold pursuant to ST’s terms and conditions of sale in place at the time of order acknowledgement.

Purchasers are solely responsible for the choice, selection, and use of ST products and ST assumes no liability for application assistance or the design of Purchasers’ products.

No license, express or implied, to any intellectual property right is granted by ST herein.

Resale of ST products with provisions different from the information set forth herein shall void any warranty granted by ST for such product.

ST and the ST logo are trademarks of ST. For additional information about ST trademarks, please refer to www.st.com/trademarks. All other product or service names are the property of their respective owners.

Information in this document supersedes and replaces information previously supplied in any prior versions of this document.

© 2019 STMicroelectronics – All rights reserved