



## ANT-GNCP-C106L160

### L1 Active Ceramic Patch GNSS Antenna

The GNCP-C106L160 is a global navigation satellite system (GNSS) ceramic patch antenna with integrated low noise amplifier (LNA), supporting GPS, Galileo, Beidou, and QZSS systems in the L1/E1/B1 bands. The LNA provides high gain with a low noise figure. The antenna is 10 mm x 10 mm and has a 60 mm cable terminated in an MHF1/U.FL-type plug (female socket) connector.

#### FEATURES

- Performance at 1575.42 MHz
  - VSWR:  $\leq 2.1$
  - Peak Gain: 24.4 dBi
  - Axial Ratio: 7.5 dB
- 25 dB (Typ.) LNA
- Ground plane independent
- Directional radiation pattern orthogonal to antenna surface
- Right-hand circularly polarized (RHCP)
- U.FL-type plug (female socket) compatible with MHF1, AMC, UMCC

#### APPLICATIONS

- Global navigation
  - GPS L1C, L1C/A
  - Galileo E1
  - L1
  - Beidou B1I, B1C
  - QZSS L1
- Timing solutions

#### ORDERING INFORMATION

Part Number	Description
ANT-GNCP-C106L160	GNSS L1 band active ceramic patch antenna with MHF1/U.FL-type plug (female socket) on 60 mm of 0.81 mm coaxial cable

Available from Linx Technologies and select distributors and representatives.

**TABLE 1. ELECTRICAL SPECIFICATIONS, ANTENNA PLUS LNA**

Frequency Band	GPS Bands	VSWR (max.)	Return Loss (dB)	Peak Gain (dBi)	Axial Ratio (dB)
1561 MHz	Beidou B1I	1.8	-10.8	14.1	6.9
1575 MHz	GPS L1C, L1C/A, Galileo E1, Beidou B1C, QZSS L1	2.1	-9.2	24.4	7.5
1601/1602 MHz	L1	3.1	-5.9	26.4	13.8
Output Impedance	50 $\Omega$				
Polarization	RHCP				
Radiation	Directional radiation pattern orthogonal to antenna surface				
Electrical Type	Radiating Patch plus LNA				
Input Voltage	Min. 2.7 V, Typ. 3.0 V, Max. 3.3 V				
Current Consumption @3.0V	Typ. 10.0 mA, Max. 13.0 mA				
Noise Figure (dB)	1.4 typ.				
ESD Sensitivity	ESD sensitive device. As a best practice, Linx uses ESD packaging.				

**TABLE 2. MECHANICAL SPECIFICATIONS, ANTENNA PLUS LNA**

Parameter	Value
Operating Temp. Range	-40 °C to +85 °C
Connection	MHF1/U.FL-type plug (female socket) on 60 mm (2.36 in) of 0.81 mm coaxial cable
Weight	2.8 g (0.10 oz)
Dimensions	10.0 mm x 10.0 mm x 6.0 mm (0.39 in x 0.39 in x 0.24 in)

## GROUND PLANE INDEPENDENT

Because of the significant signal gain provided by the antenna's LNA, the ground plane typically required for passive GNSS antenna gain performance is not required for active GNSS antennas.

## MOUNTING

The ANT-GNCP-C106L160 may be mounted by mechanical means (e.g. bracket, not included) or using the included adhesive pad. Alternatively, the antenna may be mounted by soldering the LNA base to a printed circuit board (PCB) - see application note, AN-00504 on the Linx website for more information.

## PACKAGING INFORMATION

The ANT-GNCP-C106L160 antenna is packaged in a protective plastic tray in quantities of 60 wrapped in anti-static ESD Polyethylene. Antenna trays are bundled and packaged in cartons of 360 antennas. Cartons are packaged in larger boxes in quantities of 1080 antennas. Distribution channels may offer alternative packaging options.

## PRODUCT DIMENSIONS

Figure 1 provides dimensions of the ANT-GNCP-C106L160.

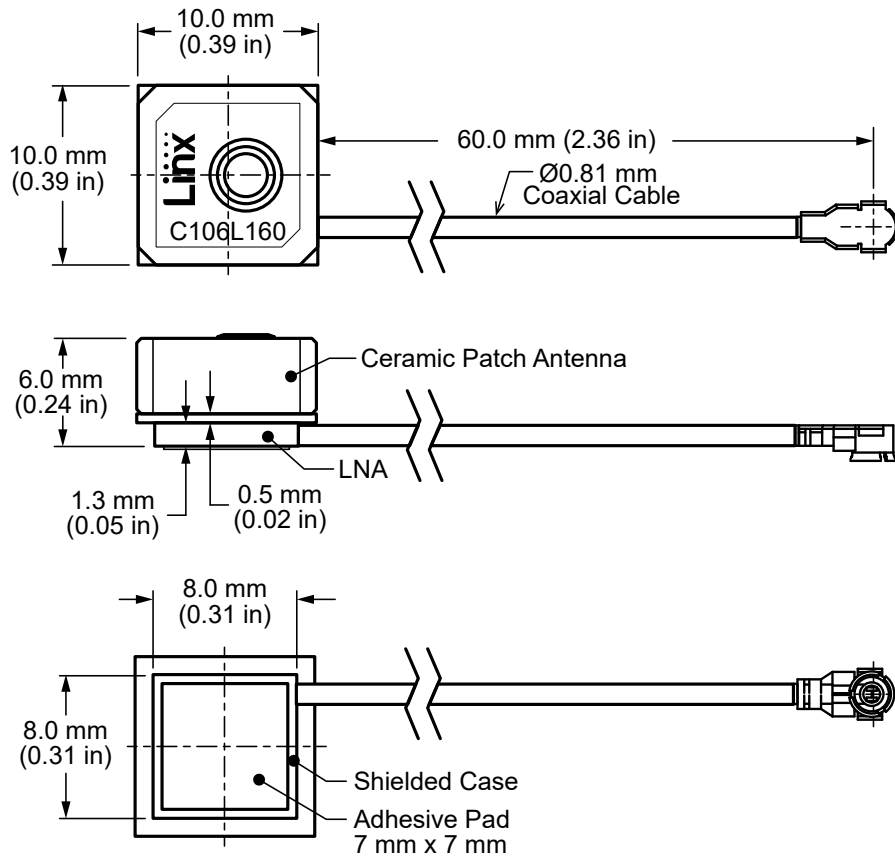

Figure 1. ANT-GNCP-C106L160 Antenna Dimensions

## VSWR

Figure 2 provides the voltage standing wave ratio (VSWR) across the antenna bandwidth. VSWR describes the power reflected from the antenna back to the radio. A lower VSWR value indicates better antenna performance at a given frequency. Reflected power is also shown on the right-side vertical axis as a gauge of the percentage of transmitter power reflected back from the antenna.

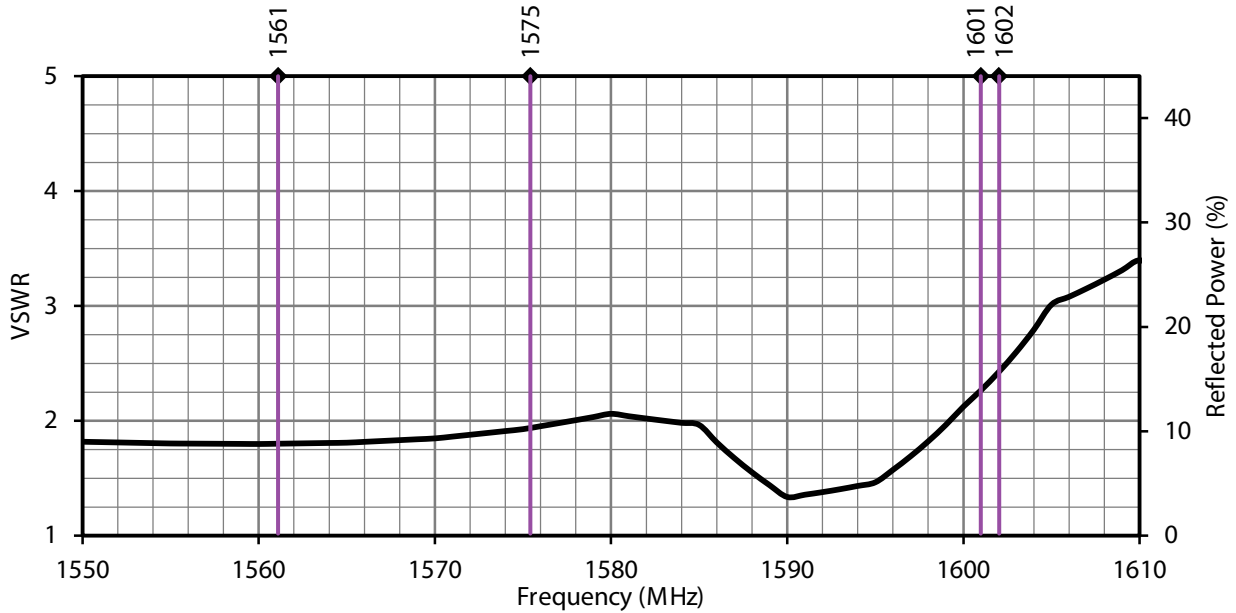

Figure 2. ANT-GNCP-C106L160 VSWR

## RETURN LOSS

Return loss (Figure 3), represents the loss in power at the antenna due to reflected signals. Like VSWR, a lower return loss value indicates better antenna performance at a given frequency.

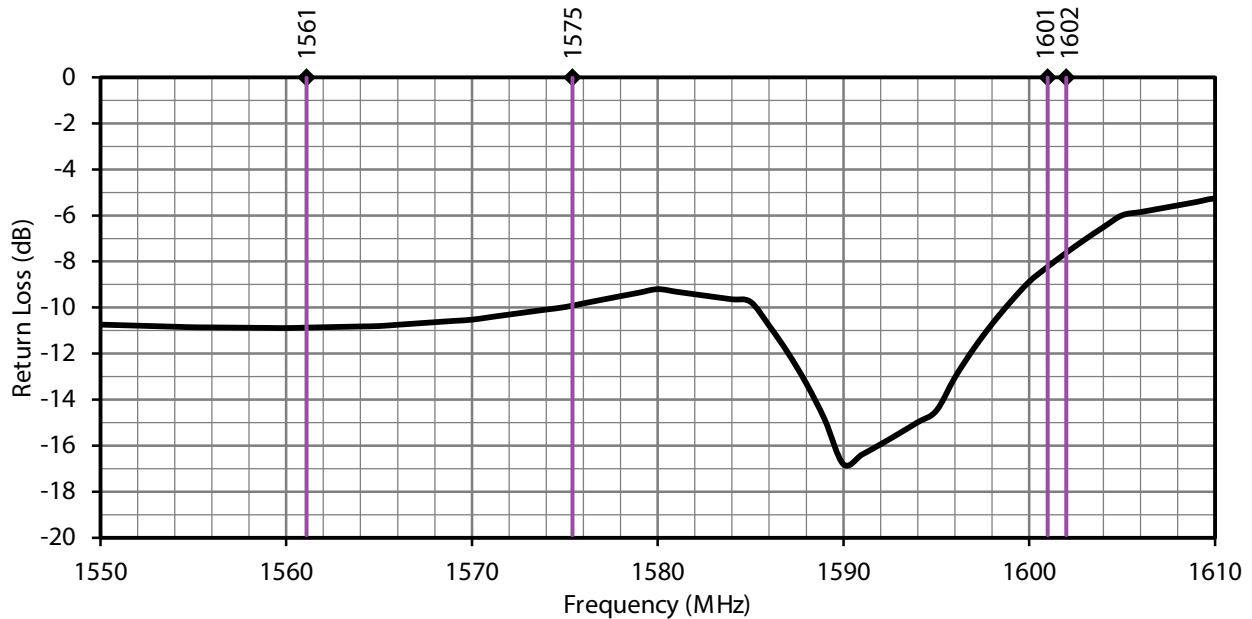

Figure 3. ANT-GNCP-C106L160 Return Loss

## PEAK GAIN

The peak gain across the antenna bandwidth is shown in Figure 4. Peak gain represents the maximum antenna input power concentration across 3-dimensional space, and therefore peak performance at a given frequency, but does not consider any directionality in the gain pattern.

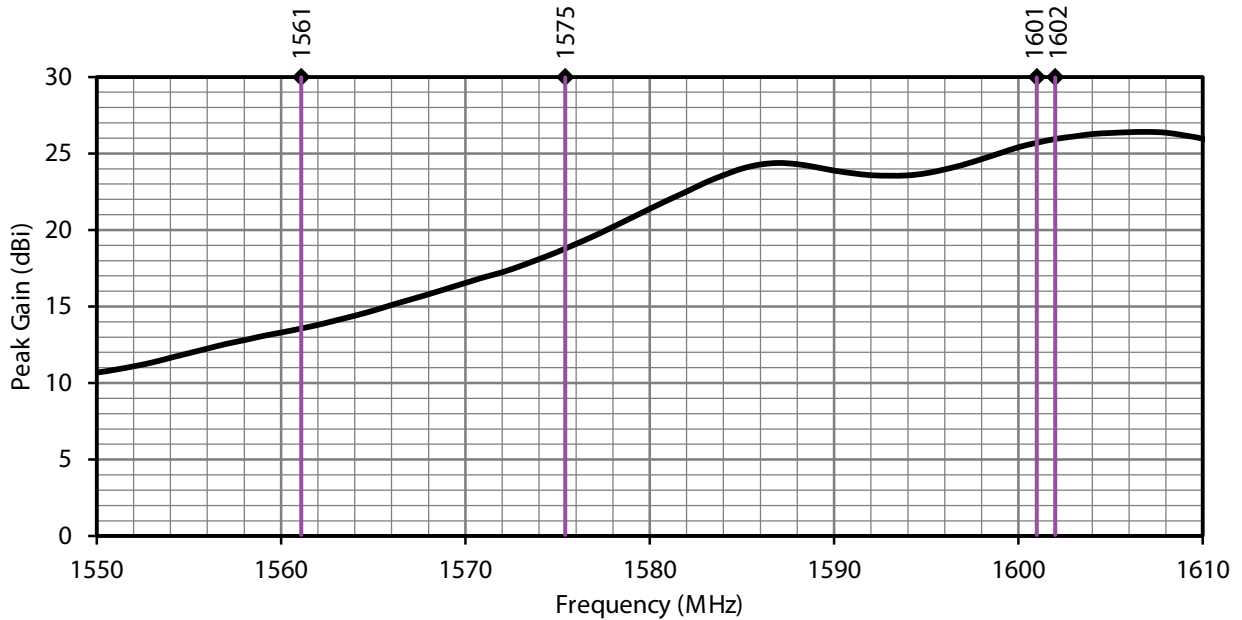

Figure 4. ANT-GNCP-C106L160 Peak Gain

## AXIAL RATIO

Axial ratio provides a measure of the quality of circular polarization of an antenna, the lower the value (in dB), the better the circular polarization. A circularly polarized antenna field comprises two orthogonal E-field components. These fields are ideally of equal amplitude, resulting in an axial ratio equal to unity (0 dB). In practice, no antenna is perfectly circular in polarization, the polarization is elliptical as one field has larger magnitude. As the axial ratio increases the antenna gain degrades away from the main beam orthogonal to the antenna surface. The axial ratio for the ANT-GNCP-C106L160 antenna is shown in Figure 5.

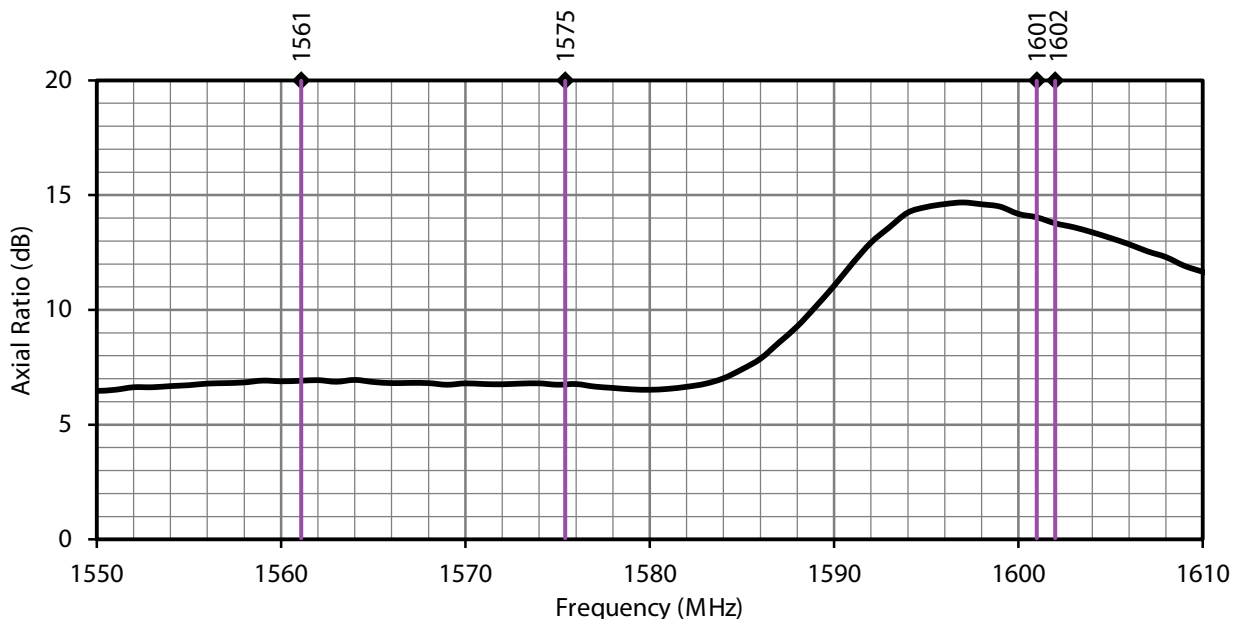
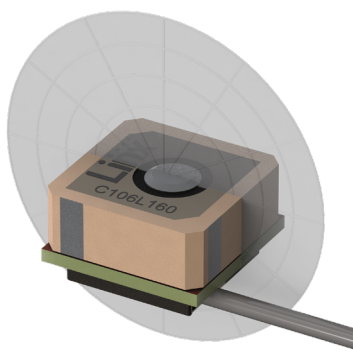

Figure 5. ANT-GNCP-C106L160 Antenna Axial Ratio

## RADIATION PATTERNS

Radiation patterns provide information about the directionality and 3-dimensional gain performance of the antenna by plotting gain at specific frequencies in three orthogonal planes. Antenna radiation patterns are shown in Figure 6 using polar plots covering 360 degrees. The antenna graphic at the top of the page provides reference to the plane of the column of plots below it. Note: when viewed with typical PDF viewing software, zooming into radiation patterns is possible to reveal fine detail.



XZ-Plane Gain

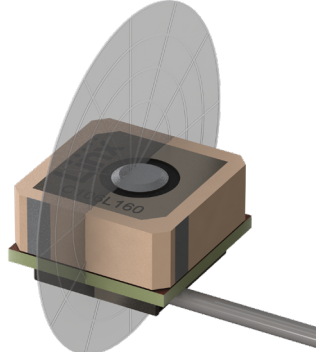

YZ-Plane Gain

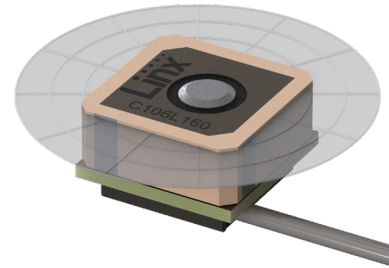

XY-Plane Gain

### 1559 MHz to 1563 MHz (1561 MHz)

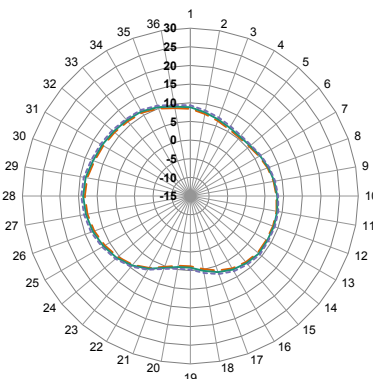

XZ-Plane Gain

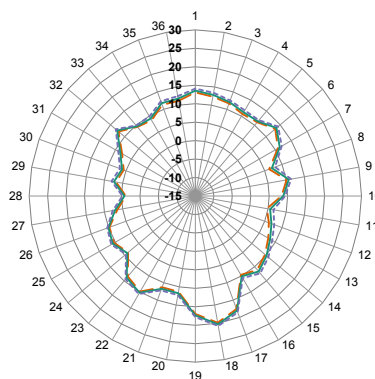

YZ-Plane Gain

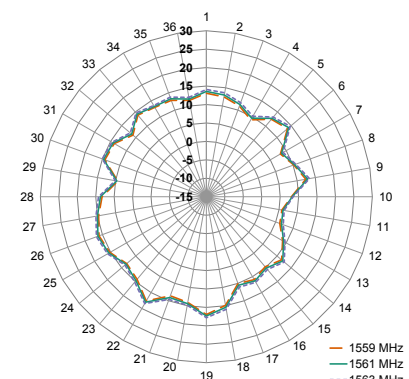

XY-Plane Gain

### 1559 MHz to 1592 MHz (1575 MHz)

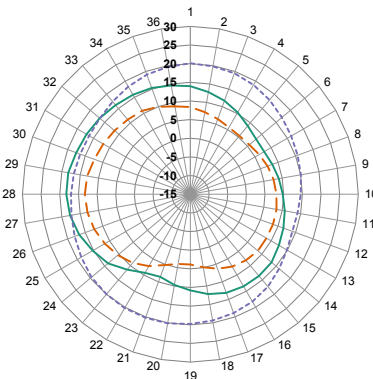

XZ-Plane Gain

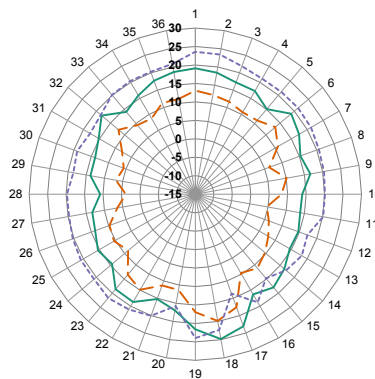

YZ-Plane Gain

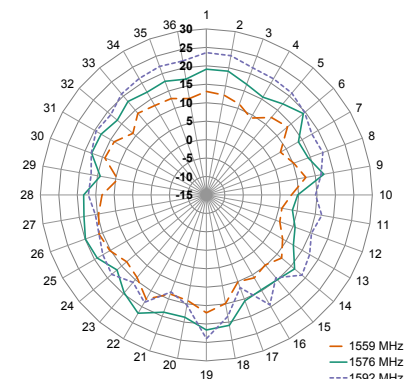

XY-Plane Gain

## 1598 MHz to 1606 MHz (1601 MHz)

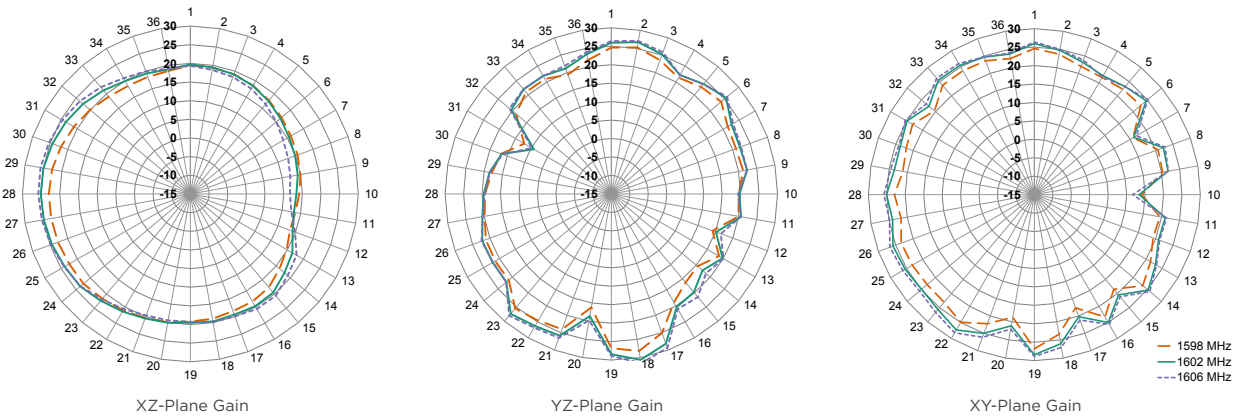

Figure 6. ANT-GNCP-C106L160 Radiation Patterns

### TE TECHNICAL SUPPORT CENTER

USA:	+1 (800) 522-6752
Canada:	+1 (905) 475-6222
Mexico:	+52 (0) 55-1106-0800
Latin/S. America:	+54 (0) 11-4733-2200
Germany:	+49 (0) 6251-133-1999
UK:	+44 (0) 800-267666
France:	+33 (0) 1-3420-8686
Netherlands:	+31 (0) 73-6246-999
China:	+86 (0) 400-820-6015

### te.com

TE Connectivity, TE, TE connectivity (logo), Linx and Linx Technologies are trademarks owned or licensed by the TE Connectivity Ltd. family of companies. All other logos, products and/or company names referred to herein might be trademarks of their respective owners.

The information given herein, including drawings, illustrations and schematics which are intended for illustration purposes only, is believed to be reliable. However, TE Connectivity makes no warranties as to its accuracy or completeness and disclaims any liability in connection with its use. TE Connectivity's obligations shall only be as set forth in TE Connectivity's Standard Terms and Conditions of Sale for this product and in no case will TE Connectivity be liable for any incidental, indirect or consequential damages arising out of the sale, resale, use or misuse of the product. Users of TE Connectivity products should make their own evaluation to determine the suitability of each such product for the specific application.

TE Connectivity warrants to the original end user customer of its products that its products are free from defects in material and workmanship. Subject to conditions and limitations TE Connectivity will, at its option, either repair or replace any part of its products that prove defective because of improper workmanship or materials. This limited warranty is in force for the useful lifetime of the original end product into which the TE Connectivity product is installed. Useful lifetime of the original end product may vary but is not warranted to exceed one (1) year from the original date of the end product purchase.

©2022 TE Connectivity. All Rights Reserved.

10/22 Original