

## 30WQ04FN SCHOTTKY RECTIFIER

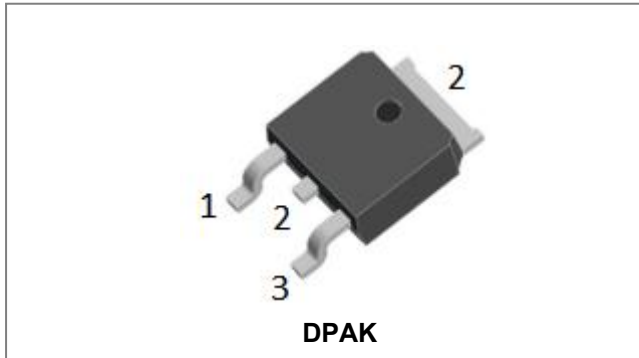

### Features

- Small foot print, surface mountable
- Low forward voltage drop
- High frequency operation
- Guard ring for enhanced ruggedness and long term reliability
- Green products in compliance with the RoHS directive
- “-A” is an AEC-Q101 qualified device
- This is a Pb – Free Device
- All SMC parts are traceable to the wafer lot
- Additional testing can be offered upon request

### Circuit Diagram

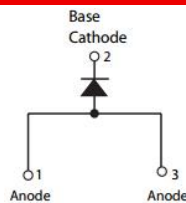

### Applications

- Disk drives
- Switching power supply
- Converters
- Free-Wheeling diodes
- Reverse battery protection
- Battery charging

### Maximum Ratings:

Characteristics	Symbol	Condition	Max.	Units
Peak Repetitive Reverse Voltage	$V_{RRM}$	-	40	V
Working Peak Reverse Voltage	$V_{RWM}$			
DC Blocking Voltage	$V_R$			
Average Rectified Forward Current	$I_{F(AV)}$	50% duty cycle @ $T_c=135^\circ\text{C}$ , rectangular wave form	3.5	A
Peak One Cycle Non-Repetitive Surge Current	$I_{FSM}$	8.3ms, Half Sine pulse, $T_c = 25^\circ\text{C}$	96	A

### Electrical Characteristics:

Characteristics	Symbol	Condition	Typ.	Max.	Units
Forward Voltage Drop*	$V_{F1}$	@ 3A, Pulse, $T_J = 25^\circ\text{C}$	0.50	0.53	V
		@ 6A, Pulse, $T_J = 25^\circ\text{C}$	0.65	0.67	
Reverse Current *	$I_{R1}$	@ $V_R = \text{rated } V_R, T_J = 25^\circ\text{C}$	0.01	2.00	mA
		@ $V_R = \text{rated } V_R, T_J = 125^\circ\text{C}$	2	24	
Junction Capacitance	$C_T$	@ $V_R = 5\text{V}, T_c = 25^\circ\text{C}$ $f_{SIG} = 1\text{MHz}$	203	300	pF

\* Pulse width < 300  $\mu\text{s}$ , duty cycle < 2%

**Thermal-Mechanical Specifications:**

Characteristics	Symbol	Condition	Specification	Units
Junction Temperature	$T_J$	-	-40 to +150	$^{\circ}\text{C}$
Storage Temperature	$T_{\text{stg}}$	-	-40 to +150	$^{\circ}\text{C}$
Typical Thermal Resistance Junction to Case	$R_{\theta\text{JC}}$	-	4.7	$^{\circ}\text{C/W}$
Approximate Weight	wt	-	0.39	g
Case Style	DPAK			

**Ratings and Characteristics Curves**

Typical Forward Characteristics

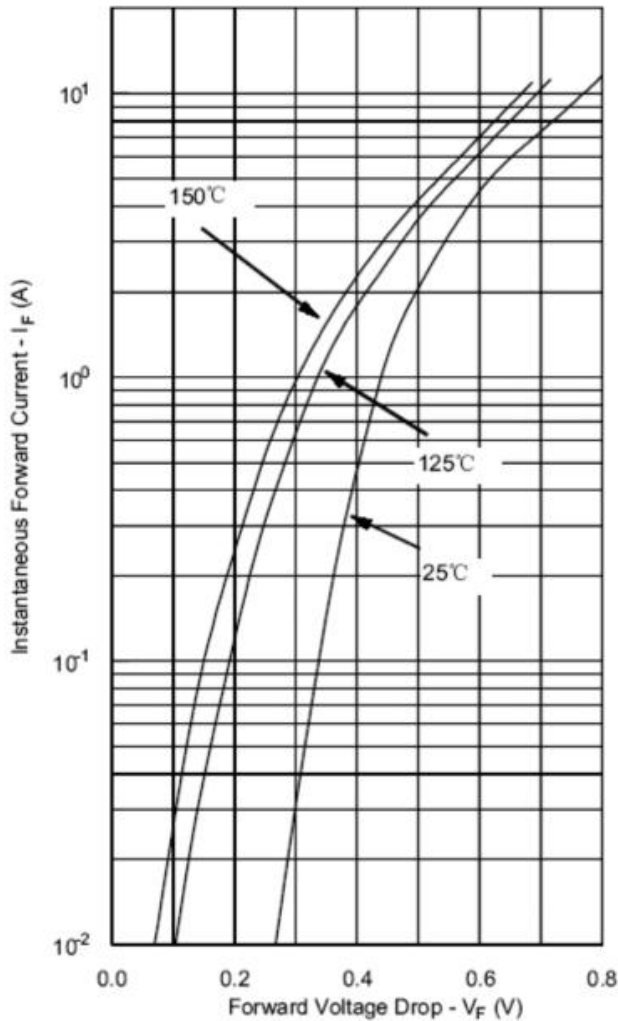

Typical Reverse Characteristics

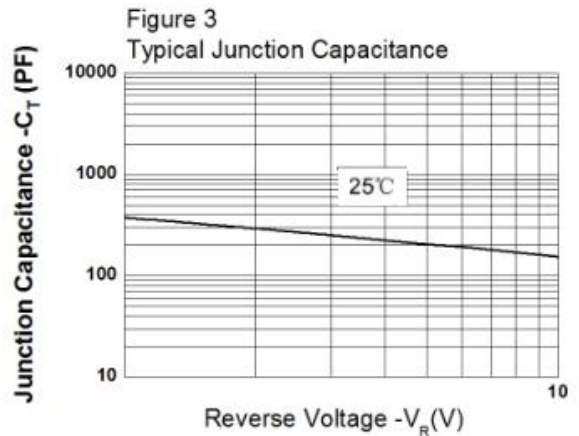
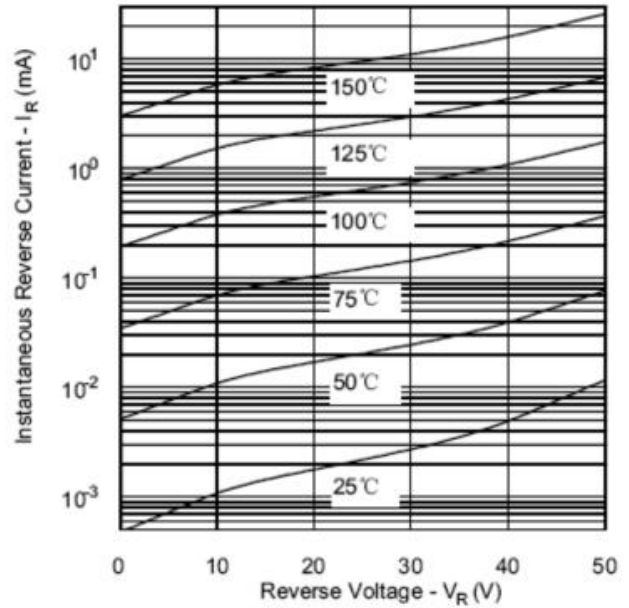

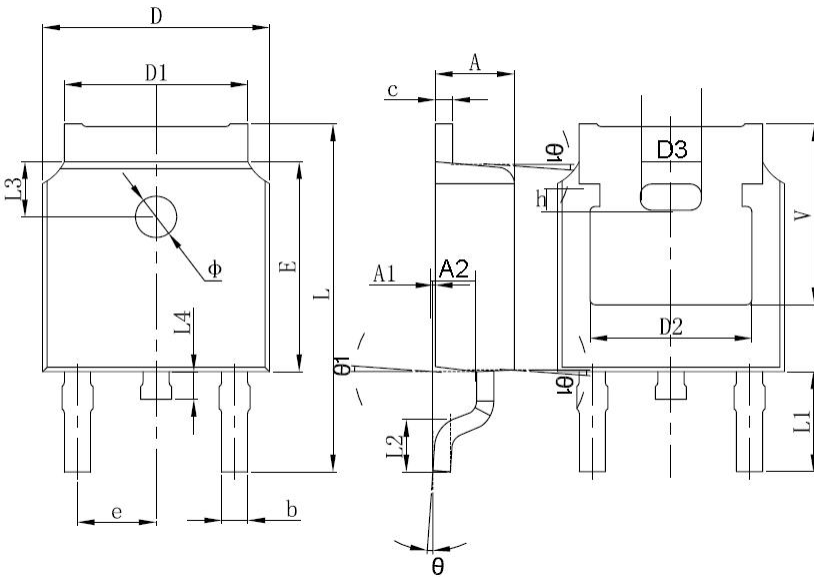
**Mechanical Dimensions DPAK**

SYMBOL	Millimeters		Inches	
	Min.	Max.	Min.	Max.
A	2.20	2.40	0.087	0.094
A1	0.00	0.127	0.000	0.005
b	0.66	0.86	0.026	0.034
c	0.46	0.60	0.018	0.024
D	6.50	6.70	0.256	0.264
D1	5.13	5.46	0.202	0.215
D2	4.83 REF.		0.190 REF.	
E	6.00	6.20	0.236	0.244
e	2.186	2.386	0.086	0.094
L	9.70	10.40	0.381	0.409
L1	2.90 REF.		0.144 REF.	
L2	1.40	1.70	0.055	0.067
L3	1.60 REF.		0.063 REF.	
L4	0.60	1.00	0.024	0.039
Φ	1.10	1.30	0.043	0.051
Θ	0°	8°	0°	8°
h	0.00	0.30	0.000	0.012
V	5.35 REF.		0.211 REF.	

**Ordering Information**

Device	Package	Plating	Shipping
30WQ04FN	DPAK (Pb-Free)	Pure Sn	2500pcs / reel
30WQ04FNTR	DPAK (Pb-Free)	Pure Sn	2500pcs / reel

For information on tape and reel specifications, including part orientation and tape sizes, please refer to our tape and reel packaging specification.

**Marking Diagram**

Where XXXXX is YYWWL

- 30 = Forward Current (3A)
- W = Configuration
- Q = Device Type
- 04 = Reverse Voltage (40V)
- FN = Package type
- SSG = SSG
- YY = Year
- WW = Week
- L = Lot Number

**Cautions:** Molding resin  
Epoxy resin UL:94V-0

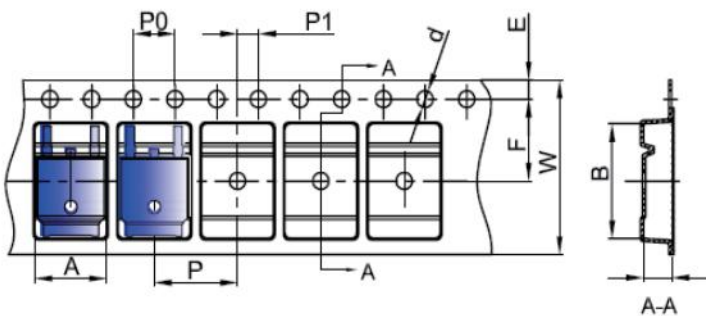
**Carrier Tape & Reel Specification DPAK**

SYMBOL	Millimeters	
	Min.	Max.
A	6.80	7.00
B	10.40	10.60
C	2.60	2.80
d	Φ1.45	Φ1.65
E	1.65	1.85
F	7.40	7.60
P0	3.90	4.10
P	7.90	8.10
P1	1.90	2.10
W	15.90	16.30

**DISCLAIMER:**

1- The information given herein, including the specifications and dimensions, is subject to change without prior notice to improve product characteristics. Before ordering, purchasers are advised to contact the SMC Diode Solutions sales department for the latest version of the datasheet(s).

2- In cases where extremely high reliability is required (such as use in nuclear power control, aerospace and aviation, traffic equipment, medical equipment, and safety equipment), safety should be ensured by using semiconductor devices that feature assured safety or by means of users' fail-safe precautions or other arrangement.

3- In no event shall SMC Diode Solutions be liable for any damages that may result from an accident or any other cause during operation of the user's units according to the datasheet(s). SMC Diode Solution assumes no responsibility for any intellectual property claims or any other problems that may result from applications of information, products or circuits described in the datasheets.

4- In no event shall SMC Diode Solutions be liable for any failure in a semiconductor device or any secondary damage resulting from use at a value exceeding the absolute maximum rating.

5- No license is granted by the datasheet(s) under any patents or other rights of any third party or SMC Diode Solutions.

6- The datasheet(s) may not be reproduced or duplicated, in any form, in whole or part, without the expressed written permission of SMC Diode Solutions.

7- The products (technologies) described in the datasheet(s) are not to be provided to any party whose purpose in their application will hinder maintenance of international peace and safety nor are they to be applied to that purpose by their direct purchasers or any third party. When exporting these products (technologies), the necessary procedures are to be taken in accordance with related laws and regulations..