

RONDA-S-C

~25° spot beam with holder C compatible with LEDiL HEKLA

TECHNICAL SPECIFICATIONS:

Dimensions	Ø 52.1 mm
Height	17.2 mm
Fastening	socket
ROHS compliant	yes ⓘ



MATERIAL SPECIFICATIONS:

Component	Type	Material	Colour	Finish
RONDA-S	Single lens	PMMA	clear	
RONDA-HLD-C	Holder	PC	white	



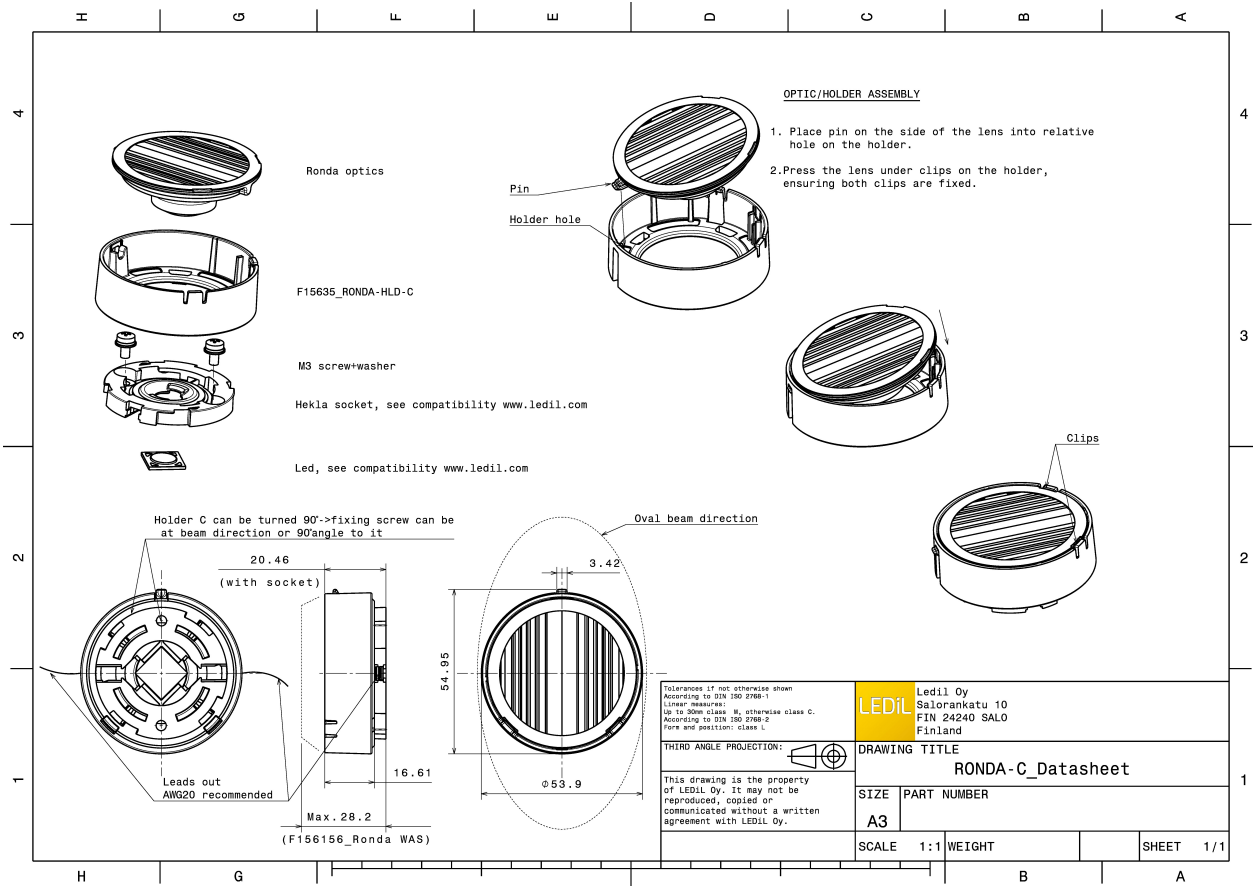

ORDERING INFORMATION:

Component	Type	Qty in box	MOQ	MPQ	Box weight (kg)
FN15970_RONDA-S-C	Single lens	420	120	30	0.0
» Box size:					



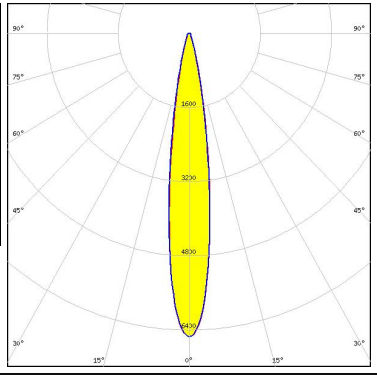

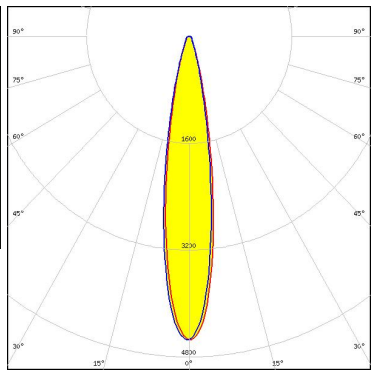

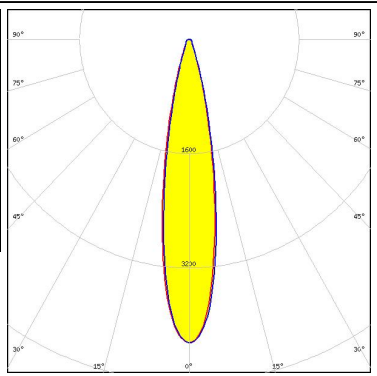
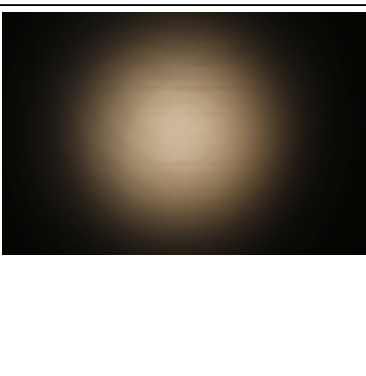
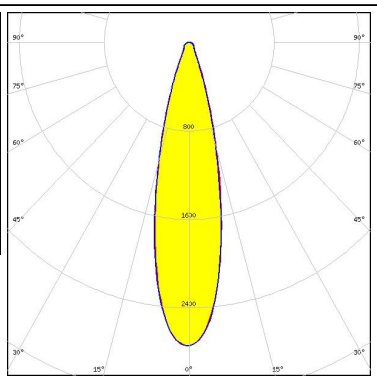

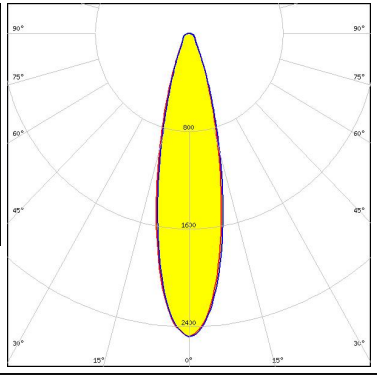

See also our general installation guide: www.ledil.com/installation_guide

PHOTOMETRIC DATA (MEASURED):

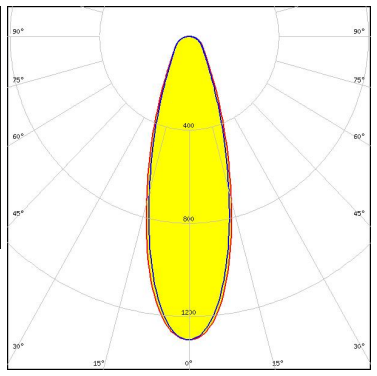
<p>bridgelux.</p> <p>LED V4 HD</p> <p>FWHM / FWTM 16.0° / 32.0°</p> <p>Efficiency 90 %</p> <p>Peak intensity 6.6 cd/m</p> <p>LEDs/each optic 1</p> <p>Light colour White</p> <p>Required components: F15253_HEKLA-SOCKET-A</p>		
<p>bridgelux.</p> <p>LED V6 Gen6</p> <p>FWHM / FWTM 18.0° / 38.0°</p> <p>Efficiency 89 %</p> <p>Peak intensity 4.5 cd/m</p> <p>LEDs/each optic 1</p> <p>Light colour White</p> <p>Required components: F15253_HEKLA-SOCKET-A</p>		
<p>bridgelux.</p> <p>LED V6 HD</p> <p>FWHM / FWTM 20.0° / 39.0°</p> <p>Efficiency 89 %</p> <p>Peak intensity 4.3 cd/m</p> <p>LEDs/each optic 1</p> <p>Light colour White</p> <p>Required components: F15255_HEKLA-SOCKET-C</p>		
<p>bridgelux.</p> <p>LED V9 HD</p> <p>FWHM / FWTM 25.0° / 49.0°</p> <p>Efficiency 87 %</p> <p>Peak intensity 2.7 cd/m</p> <p>LEDs/each optic 1</p> <p>Light colour White</p> <p>Required components: F15859_HEKLA-SOCKET-I</p>		

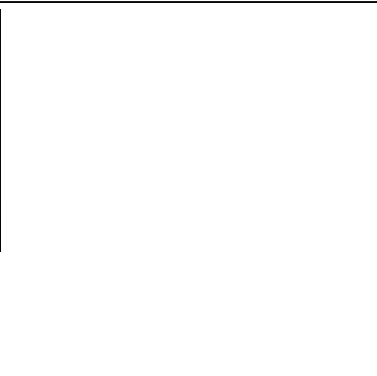
PHOTOMETRIC DATA (MEASURED):

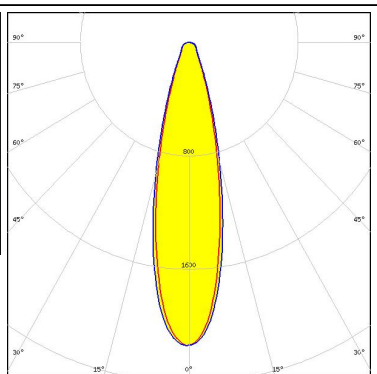
<p></p> <p>LED VERO10 FWHM / FWTM 25.0° / 53.0° Efficiency 87 % Peak intensity 2.5 cd/lm LEDs/each optic 1 Light colour White Required components: F15616_HEKLA-SOCKET-F</p>		
<p></p> <p>LED Vesta TW 13mm (25W) CSP FWHM / FWTM 32.0° / 76.0° Efficiency 79 % Peak intensity 1.3 cd/lm LEDs/each optic 1 Light colour White Required components: C16142_HEKLA-SOCKET-K Bender Wirth: 492 Typ L8</p>		
<p></p> <p>LED Vesta TW 6mm DP FWHM / FWTM 20.0° / 41.0° Efficiency 83 % Peak intensity 3.7 cd/lm LEDs/each optic 1 Light colour White Required components: C16142_HEKLA-SOCKET-K Bender Wirth: 504 Typ L8</p>		
<p></p> <p>LED Vesta TW 9mm (12W) CSP FWHM / FWTM 26.0° / 55.0° Efficiency 82 % Peak intensity 2.1 cd/lm LEDs/each optic 1 Light colour White Required components: C16142_HEKLA-SOCKET-K Bender Wirth: 489 Typ L8</p>		

PHOTOMETRIC DATA (MEASURED):

CITIZEN

LED CLC020 Series (Dim-To-Warm)
 FWHM / FWTM 28.0° / 58.0°
 Efficiency 81 %
 Peak intensity 1.9 cd/lm
 LEDs/each optic 1
 Light colour White
 Required components:
 C16142_HEKLA-SOCKET-K

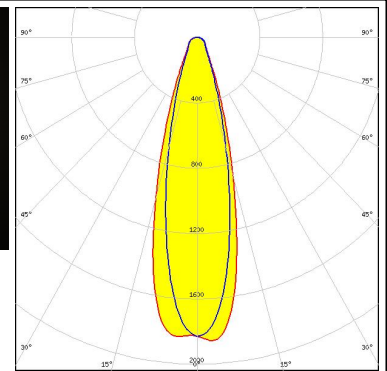
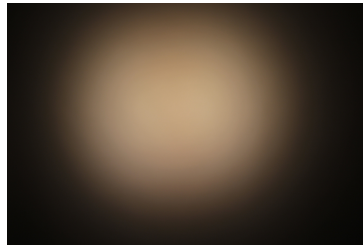

CITIZEN

LED CLL02x/CLU02x (LES10)
 FWHM / FWTM 26.0° / 54.0°
 Efficiency 86 %
 Peak intensity 2.3 cd/lm
 LEDs/each optic 1
 Light colour White
 Required components:
 F15255_HEKLA-SOCKET-C

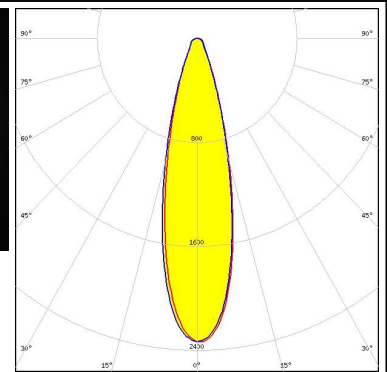
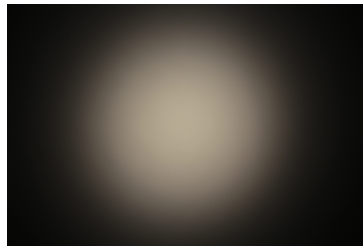

CITIZEN

LED CLU700/701/702
 FWHM / FWTM 19.0° / 39.0°
 Efficiency 87 %
 Peak intensity 4.1 cd/lm
 LEDs/each optic 1
 Light colour White
 Required components:
 F15255_HEKLA-SOCKET-C

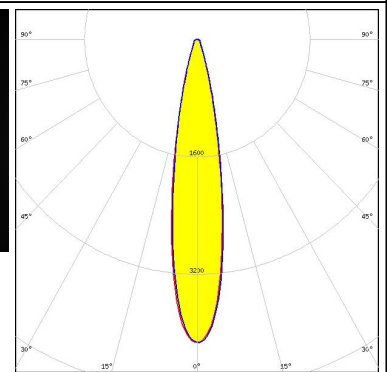
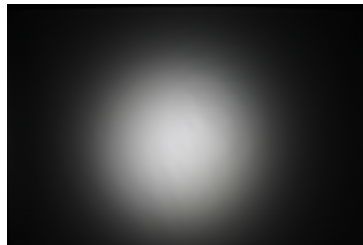

CITIZEN

LED CLU7A2 (LES 4.2mm)
 FWHM / FWTM 15.0° / 31.0°
 Efficiency 89 %
 Peak intensity 6.6 cd/lm
 LEDs/each optic 1
 Light colour White
 Required components:
 F15255_HEKLA-SOCKET-C

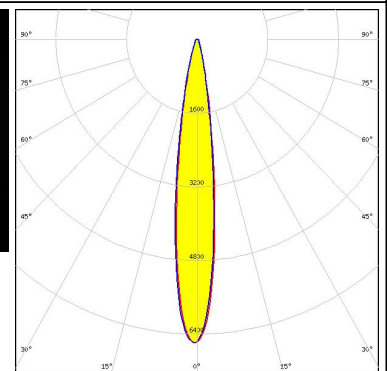

PHOTOMETRIC DATA (MEASURED):



LED CMA1516
 FWHM / FWTM 27.0° / 52.0°
 Efficiency 89 %
 Peak intensity 2.5 cd/m
 LEDs/each optic 1
 Light colour White
 Required components:
 F15256_HEKLA-SOCKET-D

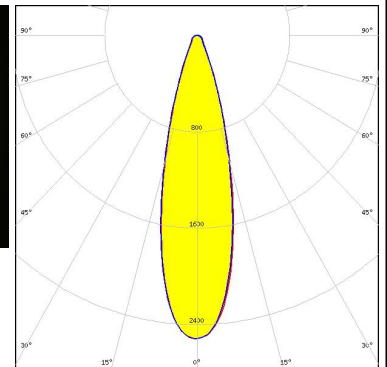
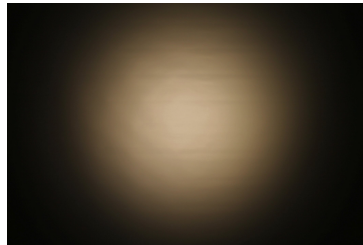

LED CMA1825
 FWHM / FWTM 33.0° / 68.0°
 Efficiency 87 %
 Peak intensity 1.6 cd/m
 LEDs/each optic 1
 Light colour White
 Required components:
 F15254_HEKLA-SOCKET-B

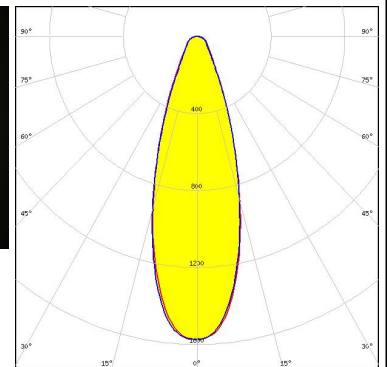
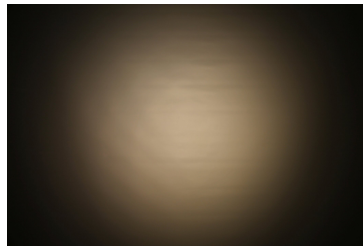

LED CMT14xx
 FWHM / FWTM 28.0° / 55.0°
 Efficiency 88 %
 Peak intensity 2.3 cd/m
 LEDs/each optic 1
 Light colour White
 Required components:
 F15255_HEKLA-SOCKET-C

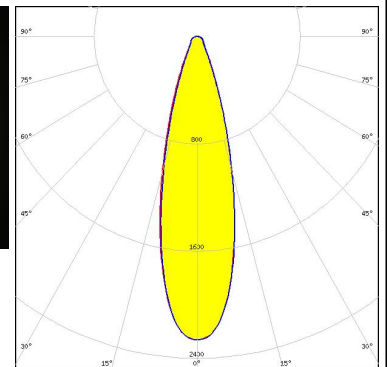
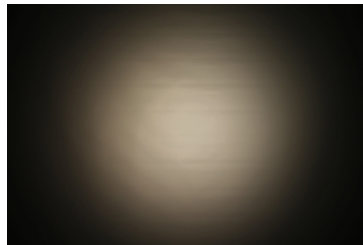

LED CMT19xx
 FWHM / FWTM 35.0° / 82.0°
 Efficiency 82 %
 Peak intensity 1.2 cd/m
 LEDs/each optic 1
 Light colour White
 Required components:
 F15859_HEKLA-SOCKET-I

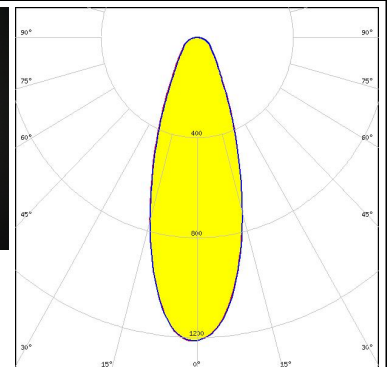
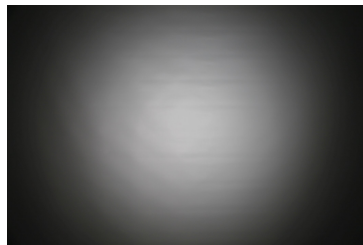

PHOTOMETRIC DATA (MEASURED):



LED CXA/B 13xx
 FWHM / FWTM 19.0° / 39.0°
 Efficiency 88 %
 Peak intensity 4.4 cd/lm
 LEDs/each optic 1
 Light colour White
 Required components:
 F15956_HEKLA-SOCKET-J

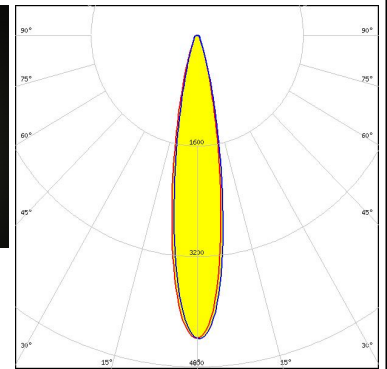
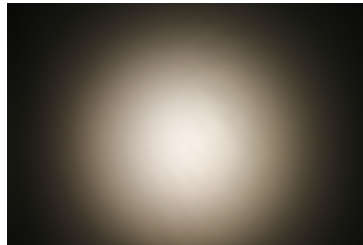

LED CXA/B 15xx
 FWHM / FWTM 25.0° / 50.0°
 Efficiency 88 %
 Peak intensity 2.7 cd/lm
 LEDs/each optic 1
 Light colour White
 Required components:
 F15256_HEKLA-SOCKET-D

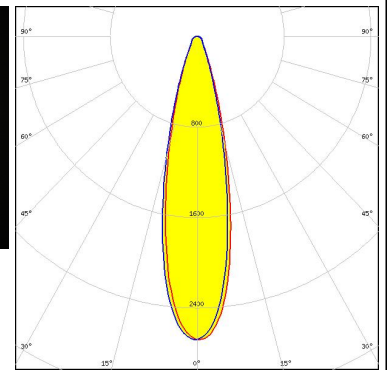
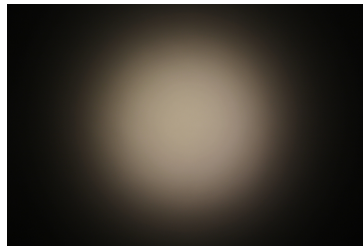

LED LUXEON CX Plus CoB L08 (Gen2)
 FWHM / FWTM 36.0° / 82.0°
 Efficiency 84 %
 Peak intensity 1.2 cd/lm
 LEDs/each optic 1
 Light colour White
 Required components:
 Bender Wirth: 637a Hekla

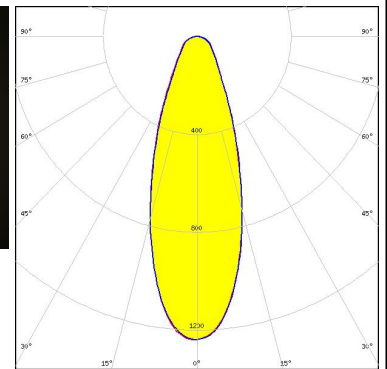
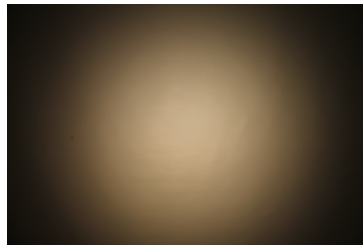

LED LUXEON CoB 1202HD
 FWHM / FWTM 21.0° / 40.0°
 Efficiency 89 %
 Peak intensity 4.1 cd/lm
 LEDs/each optic 1
 Light colour White
 Required components:
 F15848_HEKLA-SOCKET-G

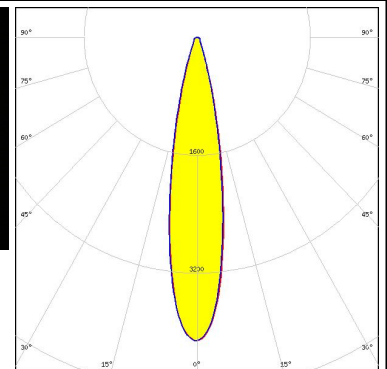
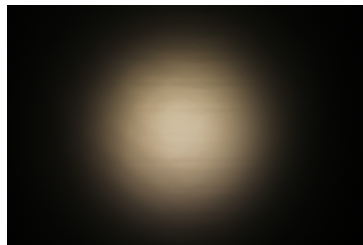

PHOTOMETRIC DATA (MEASURED):

LUMILEDS

LED LUXEON CoB 1202s
 FWHM / FWTM 19.0° / 39.0°
 Efficiency 89 %
 Peak intensity 4.4 cd/m
 LEDs/each optic 1
 Light colour White
 Required components:
 F15848_HEKLA-SOCKET-G

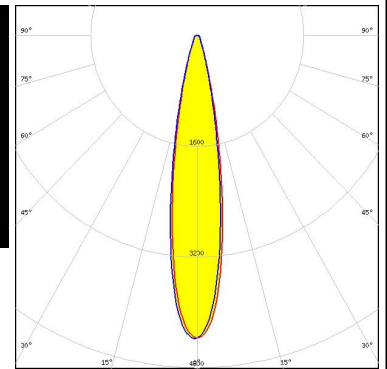

LUMILEDS

LED LUXEON CoB 1204HD
 FWHM / FWTM 27.0° / 51.0°
 Efficiency 88 %
 Peak intensity 2.5 cd/m
 LEDs/each optic 1
 Light colour White
 Required components:
 F15858_HEKLA-SOCKET-H

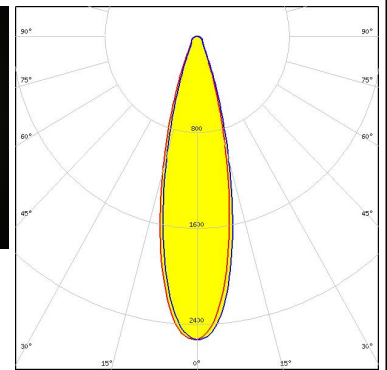
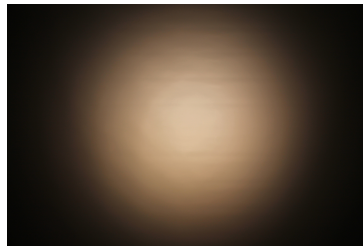

LUMILEDS

LED LUXEON CoB 1205HD
 FWHM / FWTM 31.0° / 61.0°
 Efficiency 86 %
 Peak intensity 1.8 cd/m
 LEDs/each optic 1
 Light colour White
 Required components:
 F15858_HEKLA-SOCKET-H

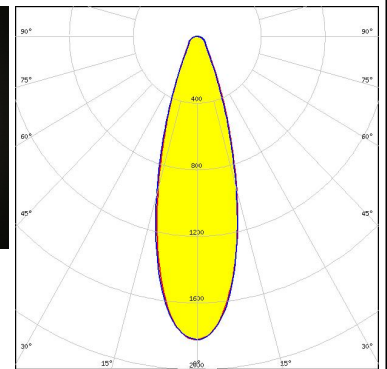
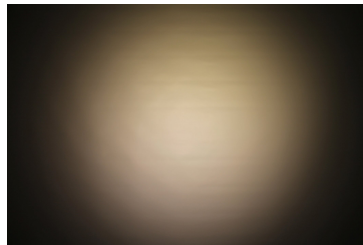





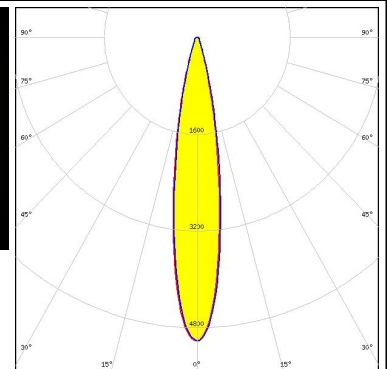
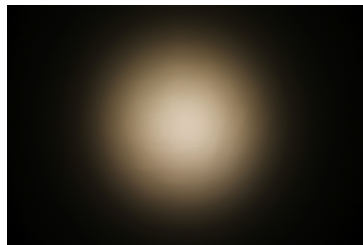

LUMILEDS

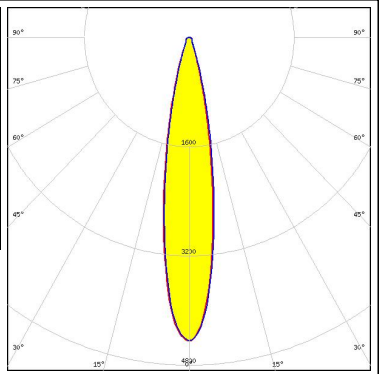

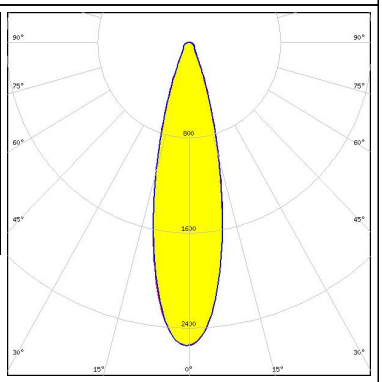

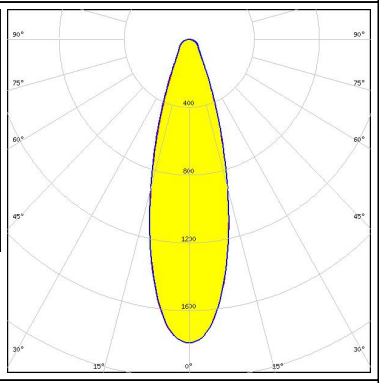

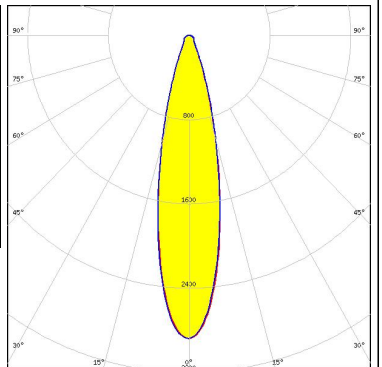
LED LUXEON CX Plus CoB - HD S01H4
 FWHM / FWTM 18.0° / 37.0°
 Efficiency 89 %
 Peak intensity 5 cd/m
 LEDs/each optic 1
 Light colour White
 Required components:
 Bender Wirth: 634c Hekla

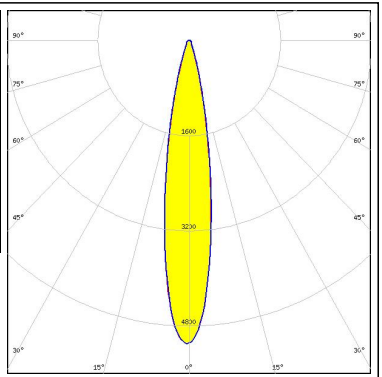

PHOTOMETRIC DATA (MEASURED):

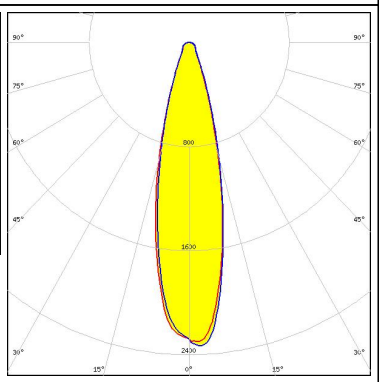
<p>LUMILEDS</p> <p>LED LUXEON CX Plus CoB - HD S01H6 / HD S02H6</p> <p>FWHM / FWTM 19.0° / 39.0°</p> <p>Efficiency 90 %</p> <p>Peak intensity 4.4 cd/m</p> <p>LEDs/each optic 1</p> <p>Light colour White</p> <p>Required components: Bender Wirth: 634c Hekla</p>		
<p>LUMILEDS</p> <p>LED LUXEON CX Plus CoB - HD S04H9</p> <p>FWHM / FWTM 26.0° / 51.0°</p> <p>Efficiency 88 %</p> <p>Peak intensity 2.6 cd/m</p> <p>LEDs/each optic 1</p> <p>Light colour White</p> <p>Required components: Bender Wirth: 634c Hekla</p>		
<p>LUMILEDS</p> <p>LED LUXEON CX Plus CoB L04 / L05 (Gen2)</p> <p>FWHM / FWTM 31.0° / 63.0°</p> <p>Efficiency 87 %</p> <p>Peak intensity 1.8 cd/m</p> <p>LEDs/each optic 1</p> <p>Light colour White</p> <p>Required components: Bender Wirth: 637a Hekla</p>		
<p>LUMILEDS</p> <p>LED LUXEON CX Plus CoB M02 / M03 (Gen2)</p> <p>FWHM / FWTM 24.0° / 48.0°</p> <p>Efficiency 88 %</p> <p>Peak intensity 2.9 cd/m</p> <p>LEDs/each optic 1</p> <p>Light colour White</p> <p>Required components: Bender Wirth: 641a Hekla</p>		

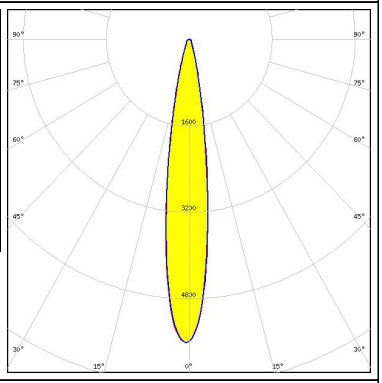
PHOTOMETRIC DATA (MEASURED):

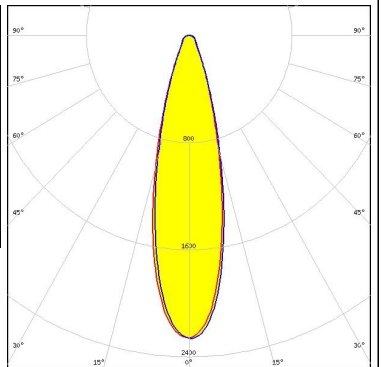
<p>LUMILEDS</p> <p>LED LUXEON CX Plus CoB S01 (Gen2)</p> <p>FWHM / FWTM 18.0° / 36.0°</p> <p>Efficiency 90 %</p> <p>Peak intensity 5.1 cd/lm</p> <p>LEDs/each optic 1</p> <p>Light colour White</p> <p>Required components: Bender Wirth: 634c Hekla</p>		
<p>LUMINUS</p> <p>LED CDM-9 (Dim-To-Warm)</p> <p>FWHM / FWTM 26.0° / 52.0°</p> <p>Efficiency 82 %</p> <p>Peak intensity 2.3 cd/lm</p> <p>LEDs/each optic 1</p> <p>Light colour White</p> <p>Required components: C16142_HEKLA-SOCKET-K Bender Wirth: 490 Typ L8</p>		
<p>LUMINUS</p> <p>LED CXM-4</p> <p>FWHM / FWTM 16.0° / 33.0°</p> <p>Efficiency 88 %</p> <p>Peak intensity 5.6 cd/lm</p> <p>LEDs/each optic 1</p> <p>Light colour White</p> <p>Required components: F15255_HEKLA-SOCKET-C</p>		
<p>LUMINUS</p> <p>LED CxM-9 (13.5x13.5)</p> <p>FWHM / FWTM 27.0° / 55.0°</p> <p>Efficiency 86 %</p> <p>Peak intensity 2.3 cd/lm</p> <p>LEDs/each optic 1</p> <p>Light colour White</p> <p>Required components: F15255_HEKLA-SOCKET-C</p>		

PHOTOMETRIC DATA (MEASURED):

PHILIPS

LED Fortimo SLM L09 CoB
 FWHM / FWTM 26.0° / 51.0°
 Efficiency 87 %
 Peak intensity 2.5 cd/m
 LEDs/each optic 1
 Light colour White
 Required components:
 F15858_HEKLA-SOCKET-H

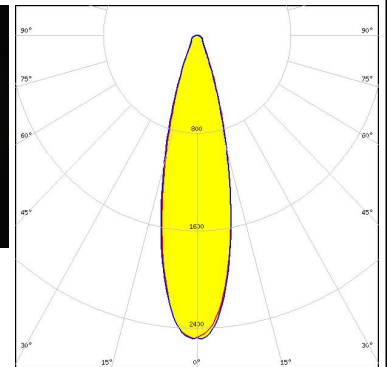
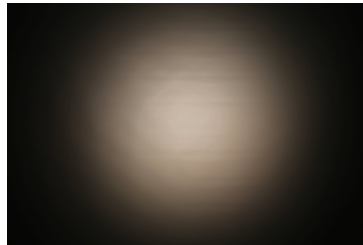

PHILIPS

LED Fortimo SLM L13 CoB
 FWHM / FWTM 33.0° / 77.0°
 Efficiency 80 %
 Peak intensity 1.3 cd/m
 LEDs/each optic 1
 Light colour White
 Required components:
 C16140_CLAMP-VERO29
 Bender Wirth: 432 Typ L8

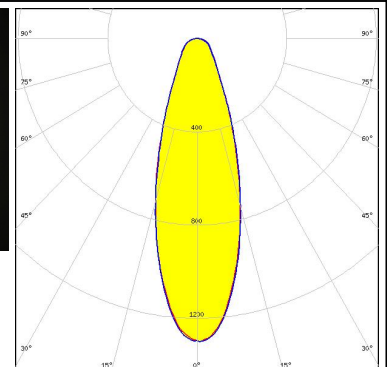
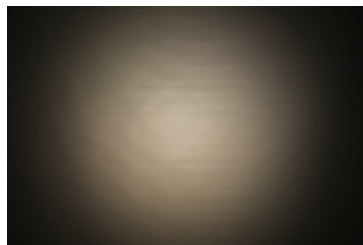

PHILIPS

LED Fortimo SLM L13 CoB
 FWHM / FWTM 33.0° / 77.0°
 Efficiency 80 %
 Peak intensity 1.3 cd/m
 LEDs/each optic 1
 Light colour White
 Required components:
 C16142_HEKLA-SOCKET-K
 Bender Wirth: 432 Typ L8

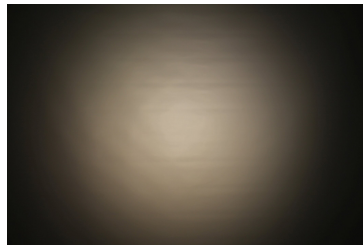

SAMSUNG

LED LC003D / LC006D / LC009D / LC013D
 FWHM / FWTM 27.0° / 55.0°
 Efficiency 87 %
 Peak intensity 2.3 cd/m
 LEDs/each optic 1
 Light colour White
 Required components:
 F15255_HEKLA-SOCKET-C

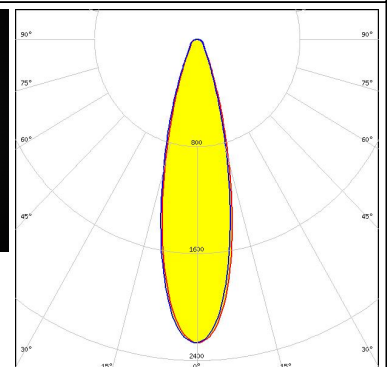
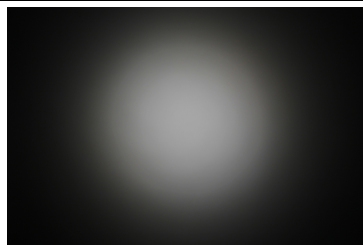

PHOTOMETRIC DATA (MEASURED):

SAMSUNG

LED LC010C
 FWHM / FWTM 20.0° / 41.0°
 Efficiency 88 %
 Peak intensity 3.8 cd/m
 LEDs/each optic 1
 Light colour White
 Required components:
 F15848_HEKLA-SOCKET-G

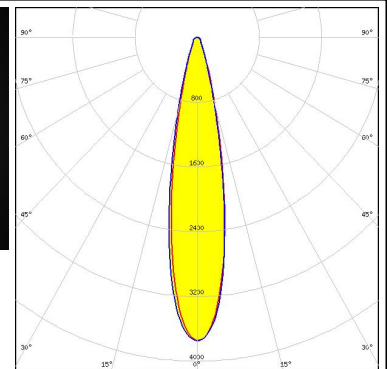
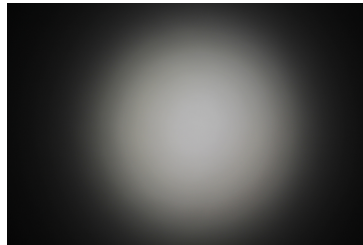

SAMSUNG

LED LC010C G2
 FWHM / FWTM 19.0° / 38.0°
 Efficiency 87 %
 Peak intensity 4.3 cd/m
 LEDs/each optic 1
 Light colour White
 Required components:
 F15255_HEKLA-SOCKET-C

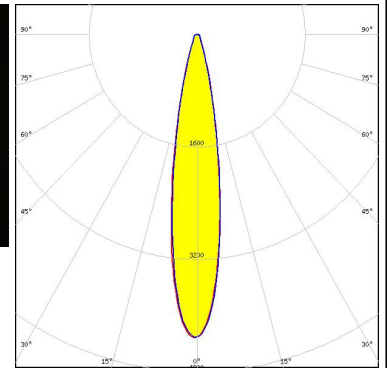
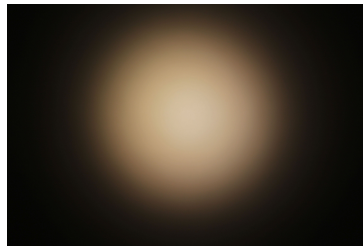

SAMSUNG

LED LC010T (Tunable White)
 FWHM / FWTM 26.0° / 56.0°
 Efficiency 82 %
 Peak intensity 2.1 cd/m
 LEDs/each optic 1
 Light colour Tunable White
 Required components:
 C16142_HEKLA-SOCKET-K
 Bender Wirth: 501 Typ L8

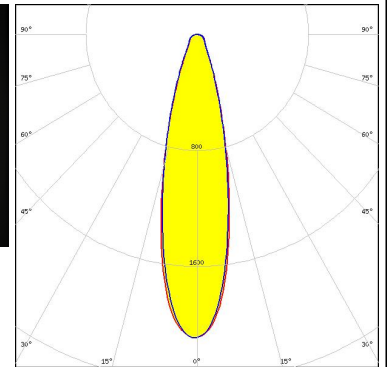
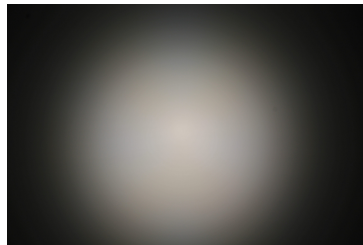

SAMSUNG

LED LC016D / LC019D / LC026D / LC033D
 FWHM / FWTM 34.0° / 85.0°
 Efficiency 79 %
 Peak intensity 1.1 cd/m
 LEDs/each optic 1
 Light colour White
 Required components:
 F15859_HEKLA-SOCKET-I

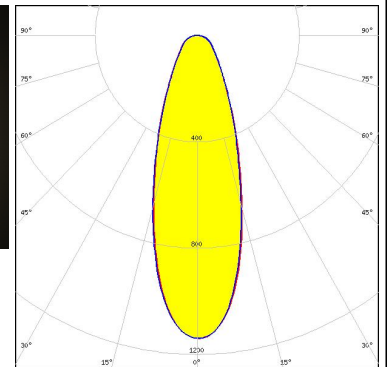
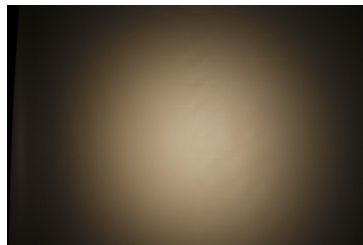

PHOTOMETRIC DATA (MEASURED):

SAMSUNG

LED LC020C
 FWHM / FWTM 24.0° / 48.0°
 Efficiency 88 %
 Peak intensity 2.9 cd/m
 LEDs/each optic 1
 Light colour White
 Required components:
 F15848_HEKLA-SOCKET-G

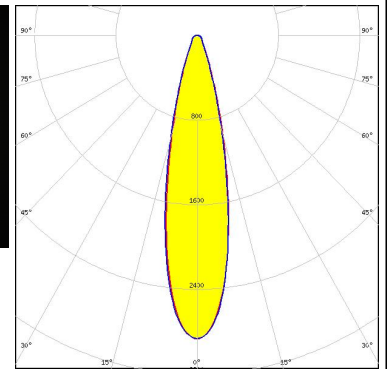
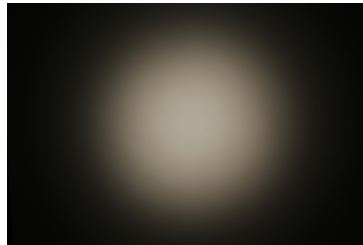

SAMSUNG

LED LC020C G2
 FWHM / FWTM 25.0° / 51.0°
 Efficiency 85 %
 Peak intensity 2.5 cd/m
 LEDs/each optic 1
 Light colour White
 Required components:
 F15859_HEKLA-SOCKET-I

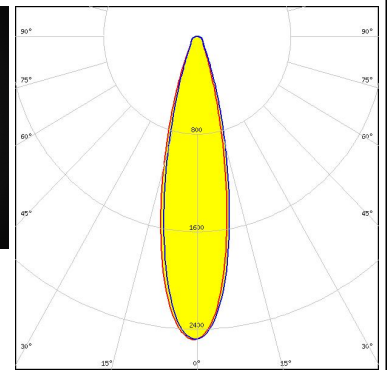
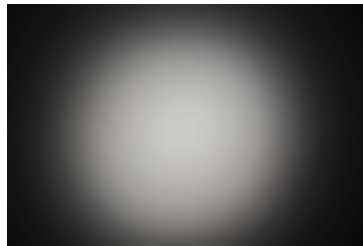

SAMSUNG



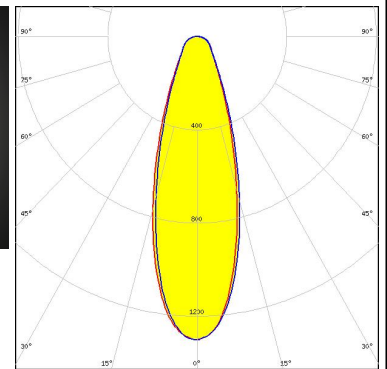
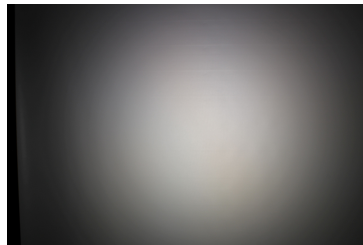

LED LC020T (Tunable white)
 FWHM / FWTM 33.0° / 76.0°
 Efficiency 79 %
 Peak intensity 1.3 cd/m
 LEDs/each optic 1
 Light colour Tunable White
 Required components:
 C16142_HEKLA-SOCKET-K
 Bender Wirth: 501 Typ L8

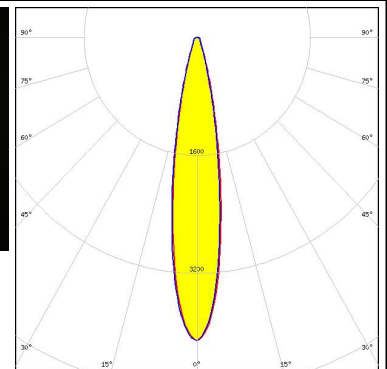
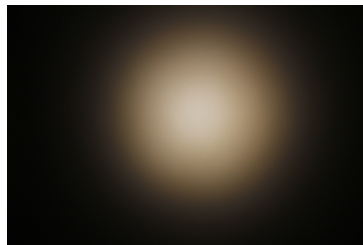

SEOL SEMICONDUCTOR
 LED MJT COB LES 6
 FWHM / FWTM 19.0° / 39.0°
 Efficiency 85 %
 Peak intensity 4.1 cd/m
 LEDs/each optic 1
 Light colour White
 Required components:
 F15255_HEKLA-SOCKET-C

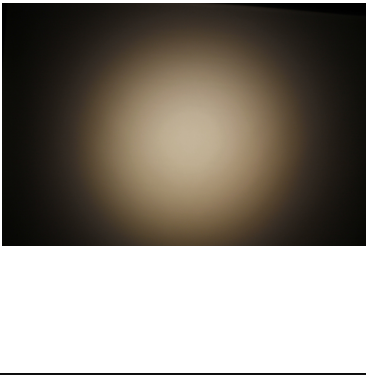
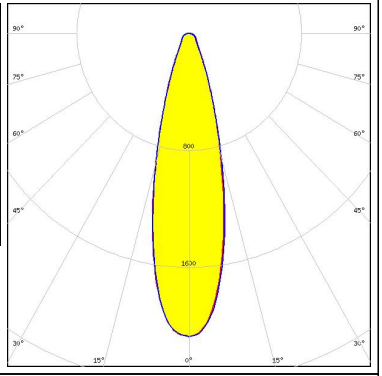

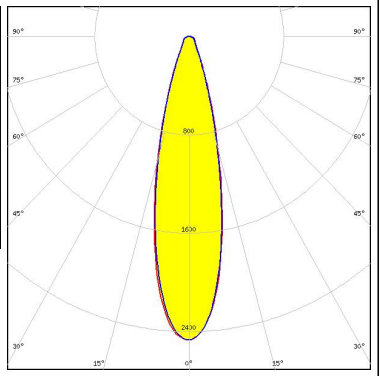
PHOTOMETRIC DATA (MEASURED):

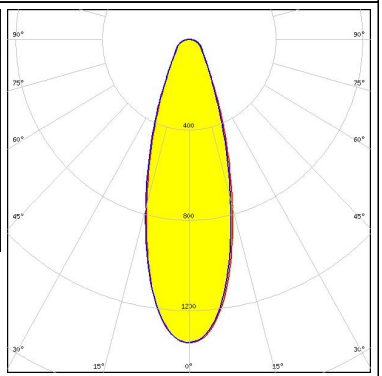
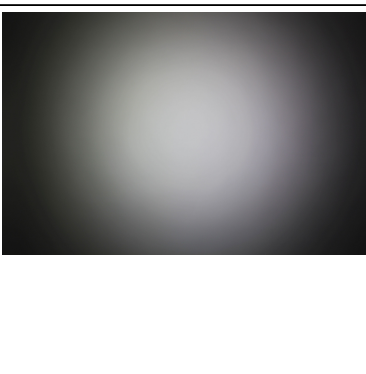
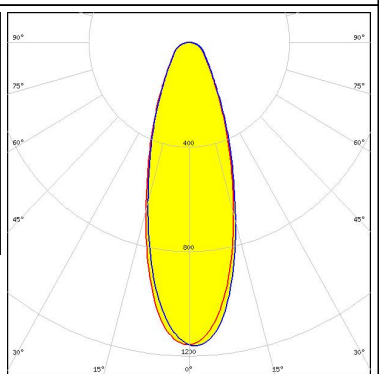
<p> SEUL SEMICONDUCTOR</p> <p>LED MJT COB LES 9.8</p> <p>FWHM / FWTM 27.0° / 56.0°</p> <p>Efficiency 83 %</p> <p>Peak intensity 2.1 cd/m</p> <p>LEDs/each optic 1</p> <p>Light colour White</p> <p>Required components: F15255_HEKLA-SOCKET-C</p>		
<p>TRIDONIC</p> <p>LED SLE G7 LES09</p> <p>FWHM / FWTM 26.0° / 52.0°</p> <p>Efficiency 86 %</p> <p>Peak intensity 2.5 cd/m</p> <p>LEDs/each optic 1</p> <p>Light colour White</p> <p>Required components: F15255_HEKLA-SOCKET-C</p>		
<p>TRIDONIC</p> <p>LED SLE G7 LES13</p> <p>FWHM / FWTM 33.0° / 75.0°</p> <p>Efficiency 81 %</p> <p>Peak intensity 1.3 cd/m</p> <p>LEDs/each optic 1</p> <p>Light colour White</p> <p>Required components: F15859_HEKLA-SOCKET-I</p>		
<p>TRIDONIC</p> <p>LED SLE G7 LES15</p> <p>FWHM / FWTM 34.0° / 84.0°</p> <p>Efficiency 80 %</p> <p>Peak intensity 1.2 cd/m</p> <p>LEDs/each optic 1</p> <p>Light colour White</p> <p>Required components: F15859_HEKLA-SOCKET-I</p>		

PHOTOMETRIC DATA (MEASURED):

XICATO

LED XOB 14.5 mm
 FWHM / FWTM 34.0° / 80.0°
 Efficiency 80 %
 Peak intensity 1.2 cd/lm
 LEDs/each optic 1
 Light colour White
 Required components:
 F15859_HEKLA-SOCKET-I

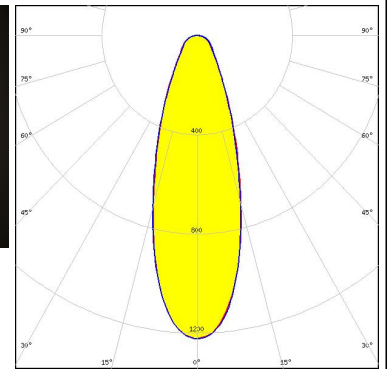

XICATO

LED XOB 9.8 mm
 FWHM / FWTM 25.0° / 53.0°
 Efficiency 87 %
 Peak intensity 2.5 cd/lm
 LEDs/each optic 1
 Light colour White
 Required components:
 F15255_HEKLA-SOCKET-C

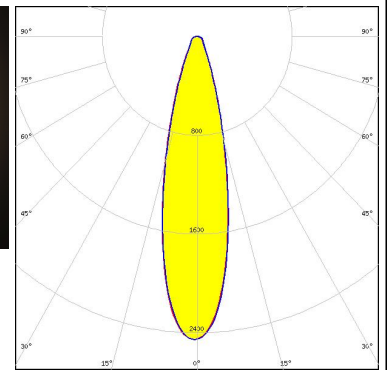

XICATO

LED XTM - 19mm LES
 FWHM / FWTM 36.0° / 108.0°
 Efficiency 80 %
 Peak intensity 0.9 cd/lm
 LEDs/each optic 1
 Light colour White
 Required components:
 C16058_XTM-ADAPTER-50-C

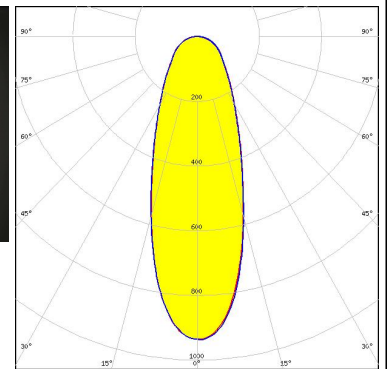
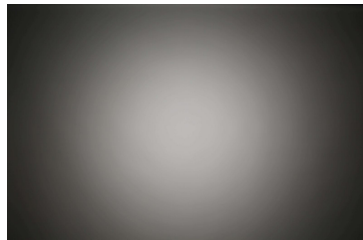

PHOTOMETRIC DATA (SIMULATED):

CITIZEN

LED CLL03x/CLU03x
FWHM / FWTM 28.0° / 68.0°
Efficiency 82 %
Peak intensity 1.8 cd/lm
LEDs/each optic 1
Light colour White
Required components:
F15859_HEKLA-SOCKET-I

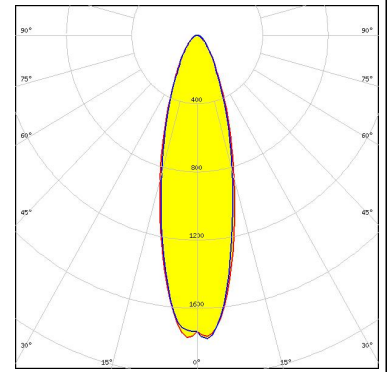

NICHIA

LED COB T-Type
FWHM / FWTM 19.0° / 38.0°
Efficiency 85 %
Peak intensity 5.7 cd/lm
LEDs/each optic 1
Light colour White
Required components:
F15848_HEKLA-SOCKET-G

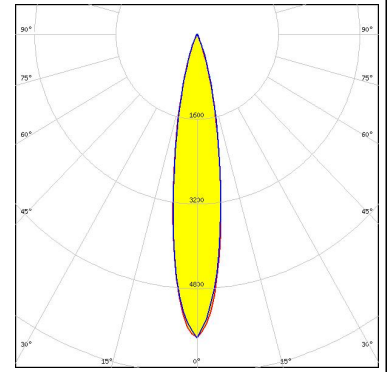

GENERAL INFORMATION:

NOTE: The typical beam angle will be changed by different color, chip size and chip position tolerance. The typical total beam angle is the full angle measured where the luminous intensity is half of the peak value.

Due to use of high power COB's with this product, special attention to proper thermal design is highly recommended. LEDiL has no liability for direct, indirect or consecutive damages arising from the LEDiL products being used outside of the recommended temperature range.

MATERIALS:

As part of our continuous research and improvement processes, and to ensure the best possible quality and availability of our products, LEDiL reserves the right to change material grades without notice.

PRODUCT DATA USER AGREEMENT AND DISCLAIMER:

The measured data in the provided downloadable LEDiL Product Datasheets and Mechanical 2D-Drawings is rounded and provided as reference for planning. LEDiL Oy's optical specifications have been verified by conducting performance testing of the products in accordance with the company's quality system. The reported data are averaged results of multiple measurements with typical variation. LEDiL Oy reserves the right to without prior notification make changes and improvements to its products.

LEDiL Oy assumes neither warranty, nor guarantee nor any other liability of any kind for the contents and correctness of the provided data. The provided data has been generated with highest diligence but the provided data may in reality not represent the complete possible variation range of all intrinsic parameters. Therefore, in certain cases a deviation from the provided data could occur.

LEDiL Oy reserves the right to undertake technical changes of its products without further notification which could lead to changes in the provided data. LEDiL Oy assumes no liability of any kind for the possible deviation from any provided data or any other damage resulting from the usage of the provided data.

The user agrees to this disclaimer and user agreement with the download or usage of the provided files.

LEDiL Oy

Joensuunkatu 13
FI-24240 SALO
Finland

LEDiL Inc.

228 West Page Street
Suite D
Sycamore IL 60178
USA

Ledil Optics Technology (Shenzhen) Co., Ltd.

405 , Block B
Casic Motor Building
Shenzhen 518057
P.R.CHINA

Local sales and technical support

[www.ledil.com/
where_to_buy](http://www.ledil.com/where_to_buy)

Shipping locations

Salo, Finland
Hong Kong, China

Distribution Partners

[www.ledil.com/
where_to_buy](http://www.ledil.com/where_to_buy)