



## D6000 SERIES USERS MANUAL



Version 1.3

## Table of Contents:

- 1.0 [Introduction](#)
- 2.0 [Configuration](#)
  - 2.1 [Getting Started](#)
- 3.0 [Communications](#)
  - 3.1 [RS-485 Serial](#)
- 4.0 [Module Types](#)
  - 4.1 [D6100 Seven Channel Voltage Input Module](#)
    - 4.1.1 [Analog to Digital Converter](#)
    - 4.1.2 [Connector Pin Assignments](#)
    - 4.1.3 [Factory Initial Values](#)
    - 4.1.4 [Features Register Assignments](#)
    - 4.1.5 [Calibration Procedure](#)
  - 4.2 [D6200 Seven Channel Current Input Module](#)
    - 4.2.1 [Analog to Digital Converter](#)
    - 4.2.2 [Connector Pin Assignments](#)
    - 4.2.3 [Factory Initial Values](#)
    - 4.2.4 [Features Register Assignments](#)
    - 4.2.5 [Calibration Procedure](#)
  - 4.3 [D6300 Seven Channel Thermocouple Module](#)
    - 4.3.1 [Analog to Digital Converter](#)
    - 4.3.2 [Connector Pin Assignments](#)
    - 4.3.3 [Factory Initial Values](#)
    - 4.3.4 [Features Register Assignments](#)
    - 4.3.5 [Calibration Procedure](#)
  - 4.4 [D6400 Seven Channel Voltage, Thermocouple, Current Input Module](#)
    - 4.4.1 [Analog to Digital Converter](#)
    - 4.4.2 [Features Register Assignments](#)
    - 4.4.3 [Factory Initial Values](#)
    - 4.4.4 [Calibration Procedure](#)
    - 4.4.5 [Connector Pin Assignments](#)
    - 4.4.6 [D6400 Current Channel Enable](#)
  - 4.5 [D6500 Two Channel Analog Output Module](#)
    - 4.5.1 [Analog Outputs](#)
    - 4.5.2 [Features Register Assignments](#)
    - 4.5.3 [Factory Initial Values](#)
    - 4.5.4 [Voltage Output Calibration Procedure](#)
    - 4.5.5 [Current Output Calibration Procedure](#)
    - 4.5.6 [Analog Output Calibration Register Tables and Values](#)
  - 4.6 [D6710 Fifteen Bit Digital Input Module](#)
    - 4.6.1 [Digital Inputs](#)
    - 4.6.2 [Connector Pin Assignments](#)
    - 4.6.3 [Factory Initial Values](#)
    - 4.6.4 [Features Register Assignments](#)
  - 4.7 [D6720 Fifteen Bit Digital Output Module](#)
    - 4.7.1 [Digital Outputs](#)
    - 4.7.2 [Connector Pin Assignments](#)
    - 4.7.3 [Factory Initial Values](#)
    - 4.7.4 [Features Register Assignments](#)
    - 4.7.5 [Communications Watchdog Timer](#)

## 5.0 [Modbus Protocol](#)

### 5.0 Functions

- 5.1 [Function 01](#) – Read Coil Status
- 5.2 [Function 02](#) – Read Input Status
- 5.3 [Function 03](#) – Read Holding Registers
- 5.4 [Function 04](#) – Read Input Registers
- 5.5 [Function 05](#) – Force Single Coil
- 5.6 [Function 06](#) – Preset Single Register
- 5.7 [Function 0F](#) – Force Multiple Coils
- 5.8 [Function 10](#) – Preset Multiple Registers

### 6.0 [Modbus Exception Error Codes](#)

## 6.0 Modbus Register Assignments

- 6.1 [Seven Channel Voltage Input Register Assignments](#)
- 6.2 [Seven Channel Current Input Register Assignments](#)
- 6.3 [Seven Channel Thermocouple Input Register Assignments](#)
- 6.4 Seven Channel Voltage, Thermocouple and Current Input Register Assignments
- 6.5 [Two Channel Analog Voltage and Current Output Register Assignments](#)
- 6.6 [Fifteen Bit Digital Output Register Assignments](#)
- 6.7 [Fifteen Bit Digital Input Register Assignments](#)

## 7.0 Calibration Procedures

- 7.1 [Seven Channel Voltage Input Module](#)
- 7.2 [Seven Channel Current Input Module](#)
- 7.3 [Seven Channel Thermocouple Input Module](#)
- 7.4 Seven Channel Voltage, Thermocouple and Current Input Module
- 7.5 [Two Channel Analog Voltage and Current Output Module](#)
- 7.6 Fifteen Bit Digital Output Module
- 7.7 Fifteen Bit Digital Input Module

**WARRANTY**

DGH warrants each D6000 series module to be free from defects in materials and workmanship under normal conditions of use and service and will replace any component found to be defective, on its return to DGH, transportation charges prepaid within one year of its original purchase. DGH assumes no liability, expressed or implied, beyond its obligation to replace any component involved. Such warranty is in lieu of all other warranties expressed or implied.

**WARNING**

The circuits and software contained in D6000 series modules are proprietary. Purchase of these products does not transfer any rights or grant any license to the circuits or software used in these products. Disassembling or decompiling of the software program is explicitly prohibited. Reproduction of the software program by any means is illegal.

As explained later in this document, all setups are performed entirely from the outside of the D6000 module. There is no need to open the module because there are no user-serviceable parts inside. Removing the cover or tampering with, modifying, or repairing by unauthorized personnel will automatically void the warranty. DGH is not responsible for any consequential damages.

**RETURNS**

When returning products for any reason, contact the factory and request a Return Authorization Number and shipping instructions. Write the Return Authorization Number on the outside of the shipping box. DGH strongly recommends that you insure the product for value prior to shipping. Items should not be returned collect as they will not be accepted.

**CONTACT INFORMATION**

DGH Corporation, USA.  
Corporate Offices  
Phone: (603) 622-0452  
Fax: (603) 622-0487  
Email: techsupport@dghcorp.com

**SHIPPING ADDRESS**

DGH Corporation  
Hillhaven Industrial Park  
146 Londonderry Turnpike  
Hooksett, NH 03106  
Attn: RMA# \_\_\_\_\_

## 1.0 Introduction

The D6000 series RS-485 serial interface modules are a complete family of data acquisition modules. The family of modules includes multi-channel analog input measurement modules, multiple channel analog output modules, and digital modules.

The D6000 series modules communicate using the Modbus RTU protocol. This protocol very popular in the data acquisition market and is supported by almost every commercial data acquisition program in the market today. Thus providing access to wide variety of software control programs that can meet almost any application budget.

The D6000 series analog input modules contain seven differential analog input channels and can measure voltages, current, and thermocouples. There are four versions available, the D6100, D6200, D6300 and the D6400. The D6100 module can measure DC voltage signals. The D6200 module can measure seven 4-20mA current loops. The D6300 series can measure eight user-selectable thermocouple types. The D6400 series can measure six selectable voltage input ranges, one current input range, and eight selectable thermocouple types.

The D6500 series analog output modules contain two output channels for generating either a voltage or current output signal. Each analog output channel is user-selectable as either a voltage or a current output. These analog output signals can be used as control inputs for items such as motor controls, valve controls, and other control devices. Each analog output channel also contains a programmable communications watchdog timer for instances when communications to the module is lost.

The D6700 series digital input and output modules each contain 15-bits of input or output. The digital input modules contain internal pull-ups on each bit for direct connection of dry contact switches. The digital outputs are open-collector outputs that can be connected up to 30Vdc and can sink 100mA per bit. The open-collector allows the modules to be used in a wider variety of control applications. The digital output module also contains a programmable watchdog timer for instances where communications to the module is lost.

Mixing and matching the D6000 series modules together in an application provides a user with all the measurement and control hardware for a complete process control system.

# 1.0 Configuration & Getting Started

## Default Mode

All D6000 series modules contain an EEPROM (Electrically Erasable Programmable Read Only Memory) to store setup information and calibration constants. The EEPROM replaces the usual array of switches and pots necessary to specify baud rate, address, parity, etc. The memory is nonvolatile which means that the information is retained even if power is removed. No batteries are used so it is never necessary to open the module case.

The EEPROM provides tremendous system flexibility since all of the module's setup parameters may be configured remotely through the communications port without having to physically change switch and pot settings. There is one minor drawback in using EEPROM instead of switches; there is no visual indication of the setup information in the module. It is impossible to tell just by looking at the module what the baud rate, address, parity and other settings are. It is difficult to establish communications with a module whose address and baud rate are unknown. To overcome this, each module has an input pin labeled DEFAULT\*. By connecting this pin to Ground, the module is put in a known communications setup called Default Mode.

The Default Mode settings are: 9600 baud, one start bit, eight data bits, one stop bit, no parity, any address is recognized. The module will answer to address "01" in the Default Mode.

Grounding the DEFAULT\* pin does not change any of the setups stored in EEPROM. The setup information may be read back to determine all of the setups stored in the module.

Setup information in a module may be changed at will in the Default Mode. The baud rate and parity setups may be changed without affecting the Default Mode values of 9600 baud and no parity. When the DEFAULT\* pin is released, the module automatically performs an internal reset and configures itself to the baud rate and parity stored in the setup information.

The Default Mode should only be used with a single module connected to a computer for the purpose of identifying and modifying setup values. In most cases, a module in Default Mode may not be used in a string with other modules.

## Communications Connections

The D6000 series module must be connected to a host computer with an RS-485 serial port for configuration. For computers that contain an internal RS-232 port then the DGH A1000 RS-232 to RS-485 serial converter can be used to connect the module to a computer. For computers without internal serial ports then a DGH USB-COMi USB to RS-485 converter can be used to connect the module to a computer. The RS-485 serial connections for both devices are detailed below.

### A1000 RS-485 Connections

A1000 RS-485 Out Connector	D6000 Module Connector
(B) GND	GND
(R) +VS	+VS
(G) DATA-	DATA-
(Y) DATA+	DATA+

### USB-COMi RS-485 Connections

USB-COMi DB-9 Connector	D6000 Module Connector
Pin 5	GND
Pin 1	DATA-
Pin 2	DATA+

**Note:** When using the USB-COMi a separate power supply will be required and connected between the +VS and GND terminals.

## DEFAULT Mode Connection

For simplicity, we recommend performing all the setups while in the Default Mode. Place the D6000 in Default Mode by connecting the DEFAULT\* terminal to the GND terminal using a jumper wire. When the module is in the Default Mode the serial parameters are internally set to: 9600 Baud, 8 data bits, no parity and one stop bit. The module will respond to Modbus Slave address "01".

**Note:** No other wiring connections are required on the analog or digital I/O pins to perform the module configuration.

## 1.1 Getting Started

The first step towards "Getting Started" with your D6000 series module is to connect the module to an RS-485 serial port using the wiring connections above. Included within the wiring connections is the "Default\*" line being connected to the power supply ground. This connection places the module in the "Default Mode". The Default Mode forces the module into a known communications state and is best utilized for configuring the module. The Default Mode serial communications parameters are: 9600 baud, eight data bits, no parity and one stop bit. The module will answer to Modbus Slave address "1" (0x01).

The D6000 series modules require a software program to change the setup register values. Since the modules communicate via the Modbus RTU protocol, a Modbus Master program or the DGH D6000 series Utility Software will be required to change the module configuration.

The DGH D6000 Series Utility Software is the best program to use when configuring a module. The utility software reads the module information, displays the information in easy to understand terms, allows changes to be made via drop-down list boxes and then writes the new values back to the module. The module parameters can also be stored to disk and recalled at a later date.

The D6000 series Utility Software is provided free of charge on CDROM with a purchase order and the latest version is always downloadable from [www.dghcorp.com](http://www.dghcorp.com). The utility software runs on Windows based computers. Simply insert the CDROM into the CDROM drive, or download the Setup.Exe file from the website, and then run the SETUP.EXE installation file. The software will install and create a menu section called "DGH DATA ACQUISITION" and the Utility Software will be under that selection.

From the computer desktop select the "start" button, select "all programs", select "DGH Data Acquisition" and then select "D6000 Series Utility Software" to run the utility software. When the software opens the first step is to select, configure and open the host serial communications port where the module is connected.

Select the “Serial Port” connection type in the upper left corner of the program screen and then select the proper communications port in the upper right hand corner of the screen. Next, press the Serial Port “Settings” button.

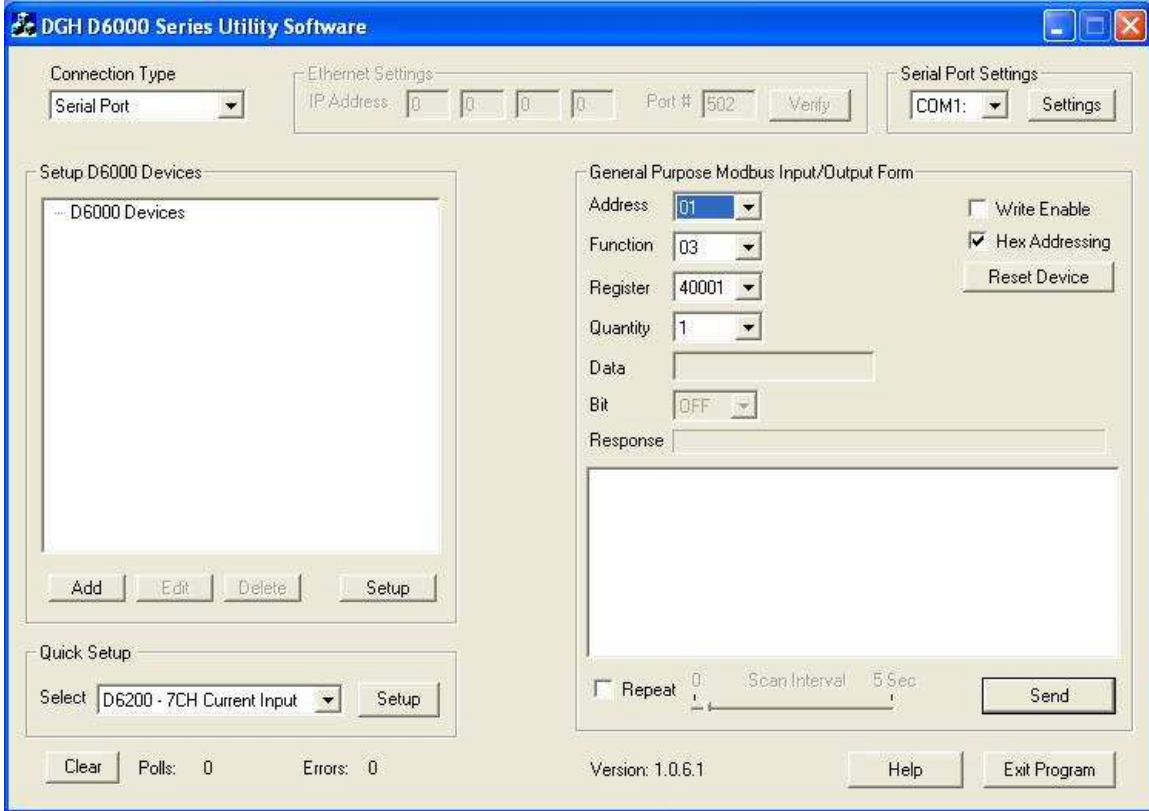

If the “Default\*” line is connected to ground then select 9600 baud, no parity, eight data bits, one stop bit, RTS Only handshaking and the Tx and Rx delays can be left in their default state. Otherwise, adjust the communications settings to match the settings in the connected module.

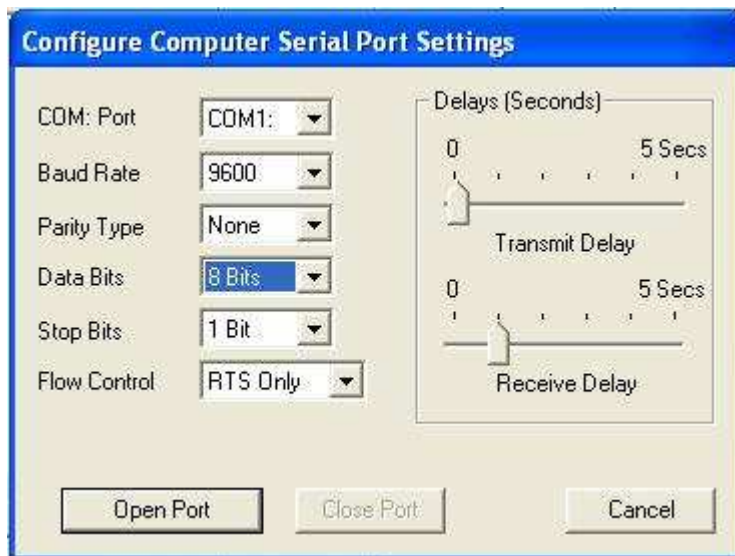

Press the “Open Port” or “Update” button to complete the serial port configuration process.

### Test Communications

After the utility software serial port has been configured the next step would be to check for valid communications between the computer and the module. You must have valid communications with the module before trying to perform the configuration process. To test the communications,



set the Modbus Address to 01 in the “Default Mode” or set the Modbus Address to match the setting in the module. Set the Function selector to 03 and the Register selector to 40001. Press the “Send” button to verify communications. A module response will be shown in the figure below.

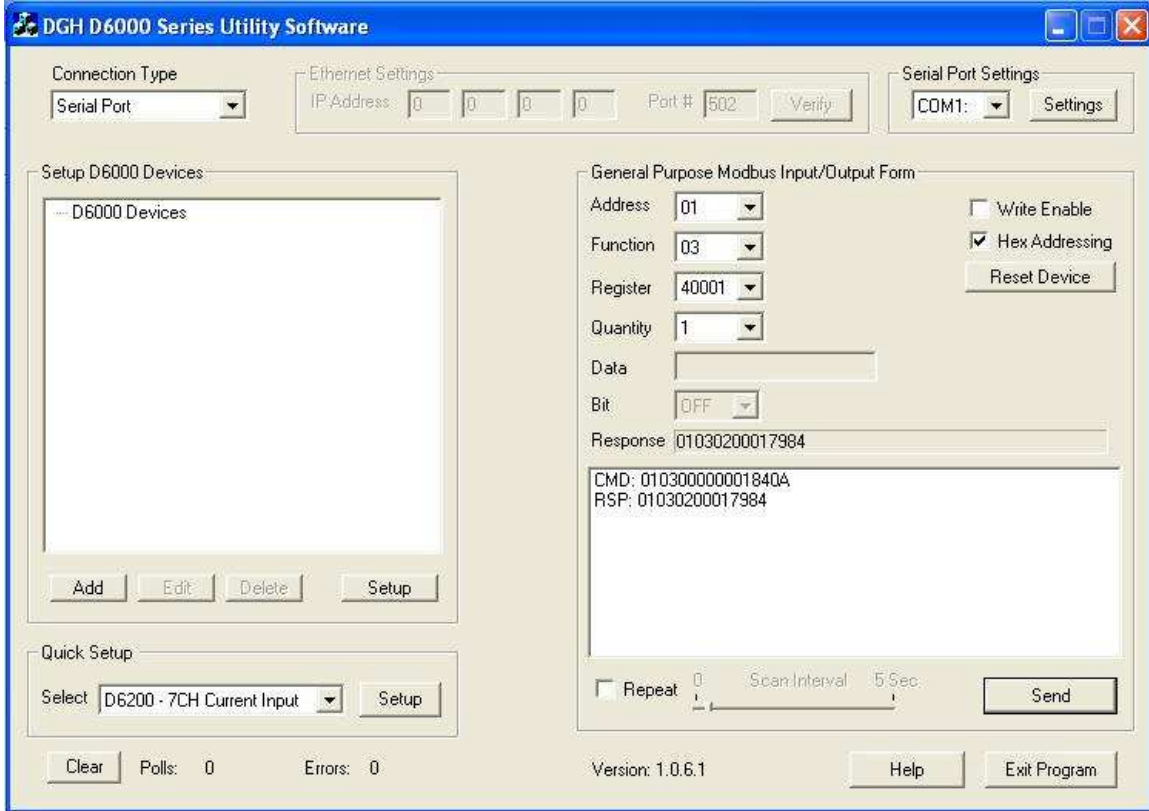

The figure above illustrates the Modbus function 03 being sent to Modbus Slave address 01. Both the command and response messages are displayed beginning with CMD and RSP respectively. This display format is provided for troubleshooting purposes as it displays each byte of information being sent to and received from the module. This format can be a good troubleshooting tool or a way to become familiar with the formatting of the Modbus RTU protocol.

The response data value from register 40001 is located in the RSP: line. The data value returned is a 16-bit value located in the fourth and fifth bytes in the message (00 01). The “00 01” indicates that the register value is 0001. From the 7CH Current Input Modbus Register map, register 40001 is the Modbus Slave address value. In the case the module slave address value is read back as 0001.

In the event that the module was not detected by the software then the RSP: line would say “RSP: Timeout – No Response Detected!”. Several things can contribute to this problem. Some examples are no power to the module, bad RS-485 wiring connection(s), invalid port settings, or RS-485 half-duplex handshaking problems all can cause timeout errors. Timeout errors must be corrected before attempting to configure a module.

## Setup a Module

After a successful communications test has been performed then the module can be configured. Select the type of module using the drop-down list box under “Quick Setup” in the lower left hand corner of the screen. Then press the “Setup” button. A new screen (see below) will appear that contains list of all the user-selectable module values. Several different screens can appear. Each screen is specific to the type of module connected. The screen below is for a seven channel current input module.

**DGH D6000 7CH Current Input Module Setup Screen**

Connection Type: Serial Port

Ethernet Settings: IP Address: 0 0 0 0 Port #: 502 Verify

Serial Port Settings: COM1: Settings

Module Setup Configuration:

Communications Settings:

Slave Address: 01

Baud Rate: 9600

Parity: N-8-2

Modbus Delays:

Delays (HI): 00 mS

Delays (LO): 00 mS

Version Data:

Software: 0000

Channel Settings:

NMR Setting: 60 Hz

Small Filter: 0 Secs.

Large Filter: 0 Secs.

Ch1 Range: Disabled

Ch2 Range: Disabled

Ch3 Range: Disabled

Ch4 Range: Disabled

Ch5 Range: Disabled

Ch6 Range: Disabled

Ch7 Range: Disabled

Analog Data Values:

	Valley (LO)	Data	Peak (HI)
Ch #1	0000	0000	0000
Ch #2	0000	0000	0000
Ch #3	0000	0000	0000
Ch #4	0000	0000	0000
Ch #5	0000	0000	0000
Ch #6	0000	0000	0000
Ch #7	0000	0000	0000

Clear LO Scan Clear HI

0 Scan Interval 5 Sec

Display Hex Values

Communications Status: \_\_\_\_\_

Module Address: 01  Hex Addressing

Read Setup Apply Help Cancel

Ensure that the Module Address in the lower left corner is 01 and then press the “Read Setup” button. The screen will now populate with the existing configuration data inside the module.

The user-selectable values will be displayed in an easy to understand format and new selections can be made using the drop-down list boxes. The drop-down list boxes make the configuration process easy and accurate because erroneous values cannot be entered.

**DGH D6000 7CH Current Input Module Setup Screen**

Connection Type: Serial Port

Ethernet Settings: IP Address: 0 0 0 0 Port #: 502 Verify

Serial Port Settings: COM1: Settings

Module Setup Configuration:

Communications Settings:

Slave Address: 01

Baud Rate: 38400

Parity: N-8-1

Modbus Delays:

Delays (HI): 00 mS

Delays (LO): 03 mS

Version Data:

Software: 0061

Channel Settings:

NMR Setting: 60 Hz

Small Filter: 4 Secs

Large Filter: 0 Secs

Ch1 Range: +/-20mA

Ch2 Range: +/-20mA

Ch3 Range: +/-20mA

Ch4 Range: +/-20mA

Ch5 Range: +/-20mA

Ch6 Range: +/-20mA

Ch7 Range: +/-20mA

Analog Data Values:

	Valley (LO)	Data	Peak (HI)
Ch #1	0000	0000	0000
Ch #2	0000	0000	0000
Ch #3	0000	0000	0000
Ch #4	0000	0000	0000
Ch #5	0000	0000	0000
Ch #6	0000	0000	0000
Ch #7	0000	0000	0000

Clear LO Scan Clear HI

0 Scan Interval 5 Sec

Display Hex Values

Communications Status: 0103020004B987

Module Address: 01  Hex Addressing

Read Setup Apply Help Cancel

Once the new module configuration settings have been changed to meet the application requirements then press the “Apply” button to transmit the new settings.

## Scan Module Data Values

After the module has been properly configured, the analog input module configuration screens can poll modules in order to verify the data from each channel. This feature is a good troubleshooting or verification tool when the analog input signals are physically connected to the module.

The analog input screens contain a “Scan” button that will start the scanning process. Each data channel is read by requesting the data values from data registers within the module. The analog input data registers can be found in the Modbus Register map and the data register locations are specific to the module type.

The data values are returned in hexadecimal percentage of Full Scale format where a value of 0x0000 represents the minus full scale input of the module. A value of 0xffff represents the positive full scale input of the module. These values can be used as check to ensure that the channels are operating properly when analog input signals are applied to the input terminals.

The data values can also be displayed as a numerical value. The utility software knows the plus and minus full scale input limits for each channel. Using the raw hexadecimal percentage of full scale data values the software can convert these readings to millivolts, milliamps, or temperature readings. Simply uncheck the “Display Hex Values” selection underneath the channel readings to display the numeric values.

The scanning process will also log and display the highest (peak) and lowest (valley) readings that were recorded during the scanning process. This is just for indication purposes only.

A scan interval slide control is also provided to speed up or slow down the scanning process. This slide control allows the channels to be scanned at intervals from 0.5 to 5 seconds.

### 3.0 Communications

Each D6000 series module contains a two-wire RS-485 serial interface for communications. The RS-485 communications standard was developed to satisfy the need for multi-dropped systems that can communicate at high data rates over long distances. RS-485 is similar to RS-422 in that it uses a balanced differential pair of wires switching from 0 to 5V to communicate data. RS-485 receivers can handle common mode voltages from -7V to +12V without loss of data, making them ideal for transmission over great distances. RS-485 differs from RS-422 by using one balanced pair of wires for both transmitting and receiving. Since an RS-485 system cannot transmit and receive at the same time it is inherently a half-duplex system.

RS-485 offers many advantages:

- 1) balanced line gives excellent noise immunity
- 2) can communicate with modules at high baud rates
- 3) communicate at distances up to 4,000 feet.
- 4) true multi-drop configuration as the modules are connected in parallel
- 5) individual modules may be disconnected without affecting other modules
- 6) up to 32 modules on one segment of the communications line; 247 with repeaters
- 7) simplified wiring using standard telephone cable

Figure 2.0 below illustrates the wiring required for multiple-module RS-485 system. Notice that every module has a direct connection to the host system. Any number of modules may be unplugged without affecting the remaining modules. Each module must be setup with a unique address and the addresses can be in any order. Also note that the connector pins on each module are labeled with notations (B), (R), (G), and (Y).

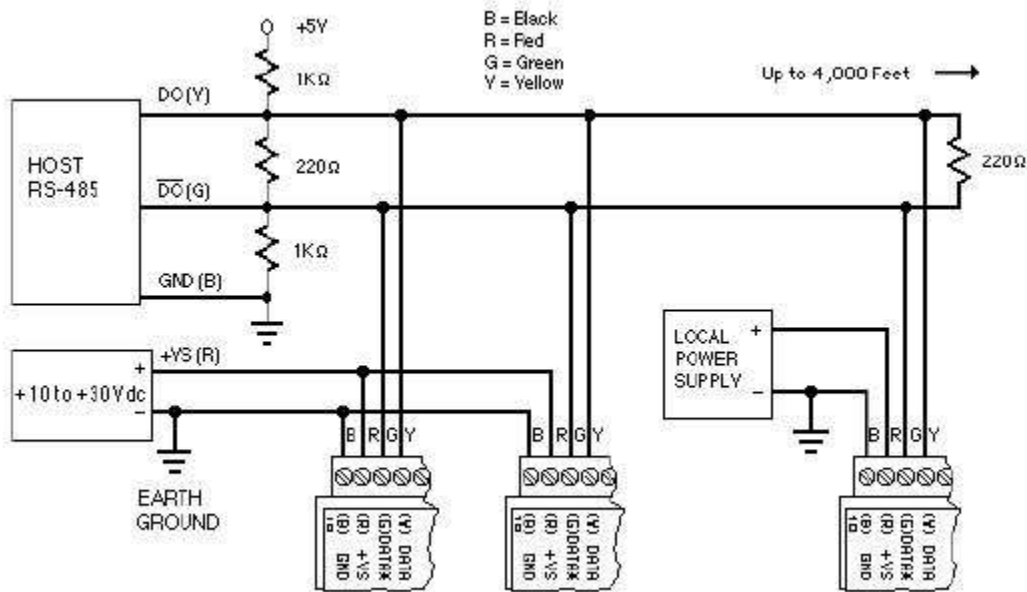

**Figure 2.0** Typical RS-485 Serial Communications System Architecture

This designates the colors used on standard 4-wire telephone cable:

(B) GND	Black Wire	
(R) V+	Red Wire	
(G) DATA*	Green Wire	(RS-485 DATA-)
(Y) DATA	Yellow Wire	(RS-485 DATA+)

This color convention can be used to simplify installation. If standard 4-wire telephone cable is used, it is only necessary to match the labeled pins with the wire color to guarantee correct installation. The RS-485 data lines are designated on the label as DATA\* and is the complement of DATA (negative true). To minimize unwanted reflections on the transmission line, the bus

should be arranged as a line going from one module to the next. 'Tree' or random structures of the transmission line should be avoided. For wire runs greater than 500 feet, each end of the line should be terminated with a 220 ohm resistor connected between DATA and DATA\*.

When using a bi-directional RS-485 system, there are unavoidable periods of time when all stations on the line are in receive mode. During this time, the communications lines are left floating and are very susceptible to noise. To prevent the generation of random characters, the lines should be biased in a MARK condition as shown in Figure 2.0. The 1K resistors are used to keep the DATA line more positive than the DATA\* line when none of the RS-485 communications transmitters are on.

When enabled, the low impedance of an RS-485 driver easily overcomes the load presented by the resistors. Special care must be taken with very long busses (greater than 1000 feet) to ensure error-free operation. Long busses must be terminated as described above. The use of twisted cable for the DATA and DATA\* lines will greatly enhance signal fidelity.

In situations where many modules are used on a long line, voltage drops in the power leads becomes an important consideration. The GND wire is used both as a power connection and the common reference for the transmission line receivers in the modules. Voltage drops in the GND leads appear as a common-mode voltage to the receivers. The receivers are rated for a maximum of -7Vdc of common-mode voltage. For reliable operation, the common mode voltage should be kept below -5V. To avoid problems with voltage drops, modules may be powered locally rather than transmitting the power from the host.

Inexpensive 'calculator' type power supplies are useful in remote locations. When local supplies are used, be sure to provide a ground reference with a third wire to the host or through a good earth ground. With local supplies and an earth ground, only two wires for the data connections are necessary.

## 4.0 Module Types

The D6000 series RS-485 serial interface modules are a complete family of data acquisition modules. Mixing and matching the D6000 series modules together in an application provides a user with all the measurement and control hardware to build a complete process control system. The family of modules includes multi-channel analog input measurement modules, multiple channel analog output modules, and digital modules.

### D6100 Voltage Input Module

The [D6100](#) series analog input modules contain seven differential inputs for measuring DC voltages. Each input can be individually configured to measure one of six different voltage ranges. The input ranges are: +/-0.025V, +/-0.05V, +/-0.10V, +/-1V, +/-5V and +/-10V.

### D6200 Current Input Module

The [D6200](#) series analog input module contains seven differential inputs for measuring current signals such as 4-20mA loops. The analog input range is factory configured for +/-20mA.

### D6300 Thermocouple Input Module

The [D6300](#) series analog input module contains seven differential inputs for measuring thermocouple probes. Each input can be individually configured to measure one of eight different thermocouple types. The supported thermocouple types are: J, K, T, E, R, S, B and C.

### D6400 Voltage, Thermocouple and Current Input Module

The [D6400](#) series analog input module contains seven differential inputs for measuring DC voltages, thermocouples and current. Each input can be individually configured to measure one of fourteen different ranges. The supported thermocouple types are: J, K, T, E, R, S, B and C. The DC voltage input ranges are: +/-0.025V, +/-0.05V, +/-0.10V, +/-1V, +/-5V and +/-10V and the current input range is +/-20mA.

### D6500 Analog Output Module

The [D6500](#) series analog output modules contain two analog output channels for generating either a voltage or current output signal. Each analog output channel contains two user-selectable voltage output ranges and two current output ranges. These analog output signals can be used as control inputs for items such as motor controls, valve controls, and other control devices. Each analog output channel also contains a programmable communications watchdog timer for instances when communications to the module is lost.

### D6700 Digital Inputs/Output Module

The [D6700](#) series modules each contain 15-bits of digital inputs or digital outputs. The D6710 15-bit digital input module contains internal pull-ups on each bit for direct connection to dry contact switches.

The D6720 digital output modules contain fifteen open-collector outputs that can be connected up to 30Vdc and can sink 100mA per bit. The open-collector outputs allow the modules to be used in a wide variety of control applications. The digital output module also contains a programmable communications watchdog timer for accidental instances where communication to the module is lost.

## 4.1 D6100 - Seven Channel Voltage Input Module

### Overview

The D6100 series analog input modules contain seven differential analog inputs that can measure six different DC voltage ranges. Each analog input channel is user programmable and may be assigned to measure a different range. Any unused channels can be disabled.

### Analog to Digital Converter

The D6100 series analog input modules contain a 16-bit analog to digital converter to perform the signal conversion to digital information. The analog to digital converter performs a total of 25 conversions per second. Meaning, if all 7 channels were enabled the each channel would be measured 3+ times per second. The conversion rate per channel can be improved by disabling any unused channels.

### Features and Register Assignments

The D6100 series analog input modules contain many user-selectable features. The user can select all features such as baud rate, parity type, analog range selection and digital filtering. The complete list of features is illustrated in the [“Seven Analog Voltage Input Register Assignments”](#) register map below. The register map format is used for consistency with the Modbus RTU protocol. The register map contains the register numbers in decimal format, register description, acceptable data values, and list of what each value means. These registers can be written to using most any Modbus master program or using the DGH D6000 series utility software.

**Note:** All Modbus Register values in the tables below are represented as “decimal” numbers.

### Factory Initial Values

The D6100 series analog module features are initialized at the factory with a set of “Initial Values”. A complete list of factory [“Initial Values”](#) can be found in the table below. For reference purposes, the Modbus Slave address is preset to hex 0x01, the baud rate is 9600, Parity type is None and the Stop Bits is “1”.

### Calibration

The D6100 series analog input modules are shipped from the factory as fully calibrated devices. Throughout the lifetime of the module there may be need to verify or adjust the calibration of the device. The verification and adjustment process should only be completed using NIST traceable calibration equipment. A D6100 series [Calibration procedure](#) is included below.

### Connector Pin Designations

The D6100 series module uses two 3.81mm removable plugs for connecting signals to the module. One six-pin connector is for the power supply and the host RS-485 data line connections. A second sixteen-pin connector is used to connect analog input signals to the module. The [pin designations](#) for each connector are printed on the module label and are listed in a table below.

## 4.1.2 Seven Voltage Input Pin Assignments and Specifications

### Connections

#### Power & Serial Communications

<u>Pin Number</u>	<u>Pin</u>	<u>Designator</u>
1	GND	- Power Supply
2	+VS	+ Power Supply
3	Data-	RS-485 Data-
4	Data+	RS-485 Data+
5	Default*	Default*
6	GND	- Power Supply

### Specifications

Analog Inputs      7 Channels

User Selectable Input Ranges  
 Bipolar Voltage      10V, 5V, 1V,  
                                  0.1V, 0.05V,  
                                  0.025V

Differential Reading  
 CH to CH

#### Analog Input Pin Assignments

<u>Pin Number</u>	<u>Pin</u>	<u>Designator</u>
1	CH1+	CH1 +Input
2	CH1-	CH1 -Input
3	CH2+	CH2 +Input
4	CH2-	CH2 -Input
5	CH3+	CH3 +Input
6	CH3-	CH3 -Input
7	CH4+	CH4 +Input
8	CH4-	CH4 -Input
9	CH5+	CH5 +Input
10	CH5-	CH5 -Input
11	CH6+	CH6 +Input
12	CH6-	CH6 -Input
13	CH7+	CH7 +Input
14	CH7-	CH7 -Input
15	ISO. GND	Isolated GND
16	ISO. GND	Isolated GND

Protocol  
 Serial                      Modbus RTU

Power Supply  
 Voltage                      +10-30Vdc  
 Power                        1.4W

Connectors  
 Spacing                      3.81mm  
 Max Wire Size              14-24 AWG  
 Max Current                8 Amperes

Serial LED Displays  
 Transmit (Top)              Serial TxData  
 Receive (Bottom)          Serial RxData



#### 4.1.3 Seven Voltage Input Initial Values

<b>Module Parameter</b>	<b>Value</b>
Slave Address	1
Baud Rate	9600
Parity Type	None
Modbus Response Delay	3mS
Modbus Query Delay	0mS
Conversion Rate	60Hz
Large Signal Filter	0 Seconds
Small Signal Filter	0 Seconds
Channel 0 Range	+/-10Vdc
Channel 1 Range	+/-10Vdc
Channel 2 Range	+/-10Vdc
Channel 3 Range	+/-10Vdc
Channel 4 Range	+/-10Vdc
Channel 5 Range	+/-10Vdc
Channel 6 Range	+/-10Vdc

#### 4.1.4 Seven Voltage Input Register Assignments

Register	Description	Function	Value	Description
40001	Slave Address	R/W	1-DF	Factory set to 0x0001.
40002	UART Setup	R/W		<p><u>Bits 0-4 Baud Rate</u>            5=9600            6=19.2K            7=38.4K            8=57.6K            9=115.2K</p> <p><u>Bits 5-6 Parity</u>            0=No Parity, 8-N-2            1=Odd            2=Even            3=No Parity, 8-N-1</p> <p><b>Factory set to 0x0035 = 9600, 8, N, 1.</b></p>
40003	Modbus Delays	R/W	0-303F	<p><u>Bits 0-7</u>            The Response Delay in milliseconds. This is required when the RS-485 adapter cannot tri-state immediately after the last character is transmitted from the host. Maximum value is 63mS. Factory default value is 3.</p> <p><u>Bits 8-15</u>            The End of Query Delay in milliseconds (48mS max). This is an additional time that the module will wait prior to marking the end of the message. Slower host computers may not be able transmit a continuous message stream, thereby creating gaps between characters exceeding the normal 3.5 character times limit. Factory default value is 0.</p> <p><b>Factory set, 0x0003.</b></p>
40033	Software Version	R		Factory set, Code Version.
40048	Last Converted Chan, Conversion Counter	R	0-06FF	<p><u>Bits 0-7</u>            The counter increments each conversion and rolled over after FF. The Conversion Counter indicates when the data registers have been updated.</p> <p><u>Bits 8-10</u>            Input channel last conversion stored. The information is useful when all channel data is read back with 1 query. The user can identify which channels have been converted since the last query as long as the time between queries is less than 8 conversion times. Initialized to '0x0000' on device reset.</p>
40049	Channel 0 Data	R	0-FFFF	Data - Ch 0, Offset binary, zero=0x8000.
40050	Channel 1 Data	R	0-FFFF	Data - Channel 1
40051	Channel 2 Data	R	0-FFFF	Data - Channel 2
40052	Channel 3 Data	R	0-FFFF	Data - Channel 3
40053	Channel 4 Data	R	0-FFFF	Data - Channel 4
40054	Channel 5 Data	R	0-FFFF	Data - Channel 5
40055	Channel 6 Data	R	0-FFFF	Data - Channel 6

40095	Misc. Setup	R/W	0-1	<p><u>Bit 0</u> – Normal Mode Rejection Setting  0 – 60Hz, 25 Hz Conversion Speed.  1 – 50Hz, 20 Hz Conversion Speed.  <b>Factory set to 0x0000.</b></p>																														
40096	Signal Filtering	R/W	0-3F	<p>This register controls all channels. Time constants are only approximate values.</p> <table> <tr> <td><u>Bits 0-3</u></td> <td><u>Small Filter Time Constant(Secs)</u></td> </tr> <tr> <td>0</td> <td>0</td> </tr> <tr> <td>1</td> <td>0.5</td> </tr> <tr> <td>2</td> <td>1</td> </tr> <tr> <td>3</td> <td>2</td> </tr> <tr> <td>4</td> <td>4</td> </tr> <tr> <td>5</td> <td>8</td> </tr> <tr> <td>6</td> <td>16</td> </tr> <tr> <td>7</td> <td>32</td> </tr> </table> <table> <tr> <td><u>Bits 4-7</u></td> <td><u>Large Filter Time Constant(Secs)</u></td> </tr> <tr> <td>0</td> <td>0</td> </tr> <tr> <td>1</td> <td>0.5</td> </tr> <tr> <td>2</td> <td>1</td> </tr> <tr> <td>3</td> <td>2</td> </tr> <tr> <td>4-7</td> <td>Reserved</td> </tr> </table> <p><b>Factory set to 0x0000.</b></p>	<u>Bits 0-3</u>	<u>Small Filter Time Constant(Secs)</u>	0	0	1	0.5	2	1	3	2	4	4	5	8	6	16	7	32	<u>Bits 4-7</u>	<u>Large Filter Time Constant(Secs)</u>	0	0	1	0.5	2	1	3	2	4-7	Reserved
<u>Bits 0-3</u>	<u>Small Filter Time Constant(Secs)</u>																																	
0	0																																	
1	0.5																																	
2	1																																	
3	2																																	
4	4																																	
5	8																																	
6	16																																	
7	32																																	
<u>Bits 4-7</u>	<u>Large Filter Time Constant(Secs)</u>																																	
0	0																																	
1	0.5																																	
2	1																																	
3	2																																	
4-7	Reserved																																	
40097	Setup Channel 0	R/W	0-F	<p>Channel 0 range. Non-volatile write protected register. If the EEPROM cannot be written because of not being enabled, it replies with a Negative Acknowledge Exception response 07h. Modbus function code 10h is limited to 4 data values.</p> <table> <tr> <td><u>Range:</u></td> <td><u>Bits 0-7 Hex</u></td> </tr> <tr> <td>Disable Channel</td> <td>00</td> </tr> <tr> <td>+/-10V</td> <td>01</td> </tr> <tr> <td>+/-5V</td> <td>02</td> </tr> <tr> <td>+/-1V</td> <td>03</td> </tr> <tr> <td>+/-0.100V</td> <td>04</td> </tr> <tr> <td>+/-0.050V</td> <td>05</td> </tr> <tr> <td>+/-0.025V</td> <td>06</td> </tr> </table> <p><b>Factory set to 0x0001.</b></p>	<u>Range:</u>	<u>Bits 0-7 Hex</u>	Disable Channel	00	+/-10V	01	+/-5V	02	+/-1V	03	+/-0.100V	04	+/-0.050V	05	+/-0.025V	06														
<u>Range:</u>	<u>Bits 0-7 Hex</u>																																	
Disable Channel	00																																	
+/-10V	01																																	
+/-5V	02																																	
+/-1V	03																																	
+/-0.100V	04																																	
+/-0.050V	05																																	
+/-0.025V	06																																	
40098	Setup Channel 1	R/W	0-F	<p>Holds Channel 1 range.  <b>Factory set to 0x0001.</b></p>																														
40099	Setup Channel 2	R/W	0-F	<p>Holds Channel 2 range.  <b>Factory set to 0x0001.</b></p>																														
40100	Setup Channel 3	R/W	0-F	<p>Holds Channel 3 range.  <b>Factory set to 0x0001.</b></p>																														
40101	Setup Channel 4	R/W	0-F	<p>Holds Channel 4 range.  <b>Factory set to 0x0001.</b></p>																														
40102	Setup Channel 5	R/W	0-F	<p>Holds Channel 5 range.  <b>Factory set to 0x0001.</b></p>																														
40103	Setup Channel 6	R/W	0-F	<p>Holds Channel 6 range.  <b>Factory set to 0x0001.</b></p>																														
40114	Trim Zero, 10V Range	WP	0	<p>Forces all Channel Data Registers to 8000h, with input signal equal to zero. Apply calibration signal at least 15 seconds prior to calibrating to all channels. Calibration Acknowledge Exception Response. Calibration takes 20 seconds.</p>																														
40115	Trim Zero, 5V Range	WP	0	<p>Refer to Modbus register 40114.</p>																														
40116	Trim Zero, 1V Range	WP	0	<p>Refer to Modbus register 40114.</p>																														
40117	Trim Zero, 0.1V	WP	0	<p>Refer to Modbus register 40114. Apply</p>																														

	Range			calibration signal at least 1 minute prior to calibrating to all channels.
40118	Trim Zero, 0.05V Range	WP	0	Refer to Modbus register 40114. Apply calibration signal at least 1 minute prior to calibrating to all channels.
40119	Trim Zero, 0.025V Range	WP	0	Refer to Modbus register 40114. Apply calibration signal at least 1 minute prior to calibrating to all channels.
40146	Trim FS, 10V Range	WP	D000-FFFE	Forces all Channel Data Registers to written value, with appropriate input signal. Apply calibration signal at least 15 seconds prior to calibrating to all channels. Acknowledge Exception Response. Calibration takes 20 seconds. See note 1.
40147	Trim FS, 5V Range	WP	D000-FFFE	See Modbus Register 40146.
40148	Trim FS, 1V Range	WP	D000-FFFE	See Modbus Register 40146.
40149	Trim FS, 0.1V Range	WP	D000-FFFE	See Modbus Register 40146. Apply calibration signal at least 1 minute prior to calibrating to all channels.
40150	Trim FS, 0.05V Range	WP	D000-FFFE	See Modbus Register 40146. Apply calibration signal at least 1 minute prior to calibrating to all channels.
40151	Trim FS, 0.025V Range	WP	D000-FFFE	See Modbus Register 40146. Apply calibration signal at least 1 minute prior to calibrating to all channels.
<b>40241</b>	<b>Control Register</b>	W		<b>0</b> – Normal operation (NOP) <b>1</b> – Remote Reset (write protected) <b>2</b> – Write Enable <b>5</b> – Initialize Host Communication setup

**Functions:**

R        Read Only  
R/W     Read/Write  
WP      Write-Protected

## 4.1.5 Seven Channel Voltage Input Module Calibration Procedure

### Required Equipment:

1. Computer running the DGH Utility Software or another Modbus Master program.
2. A NIST traceable DC Voltage Standard with +/-10Vdc range.

### Setup Steps – Perform Calibration Steps in Order Listed:

1. Allow unit to warm up for 15 minutes.
2. Short all the +Input pins together using short jumper wires.
3. Short all the -Input pins together using short jumper wires.
4. Connect the +Input wires to the Positive terminal on the DC voltage calibrator.
5. Connect the -Input wires to the Negative terminal on the DC voltage calibrator.
6. Install the DGH Utility Software or another Modbus Master Program to communicate with, and calibrate with the module via serial port or a TCP/IP connection.

### Trim Zero:

1. Set the DC calibrator voltage output to +0.0000Vdc.
2. Use the DGH Utility Software or a Modbus Master program to perform steps #3 & #5.
3. Set all channels to the same range. Start with +/-10Vdc range, work downward as per values in Table 1.0.
4. Trim Zero on all channels.
  - a. Write a value of 0x0002h to Control Register 40241 to Write-Enable the module.
  - b. Retrieve Trim Zero register value for specific range from Table 2.0 below.
  - c. Write value of 0x00h to Range Trim Zero register, (ie. 40114 for +/-10V).
  - d. Perform steps #4a through #4c to trim zero on each range.

### Trim Span:

1. Set the DC calibrator voltage output to +10.000Vdc.
2. Use the DGH Utility Software or a Modbus Master program to perform steps #3 & #5.
3. Set all channels to the same range. Start with +/-0.025Vdc range, work upward as per values in Table 3.0.
4. Trim Span on each channel.
  - a. Write a value of 0x0002h to Control Register 40241 to Write-Enable the module.
  - b. Retrieve Trim Span register value for specific range from Table 2.0 below.
  - c. Write value of 0xfffe to Trim Span register, (ie. 40146 for +/-10V).
  - d. Perform steps #4a through #4c to trim span on each range.

#### 4.1.6 Seven Channel Voltage Input Calibration Tables:

<b>Seven Channel Range Register Values</b>			
<b>Channel</b>	<b>Range Control</b>	<b>Range Values</b>	
Channel 0	40097	00	Disabled
Channel 1	40098	01	+/-10V
Channel 2	40099	02	+/-5V
Channel 3	40100	03	+/-1V
Channel 4	40101	04	+/-0.1V
Channel 5	40102	05	+/-0.05V
Channel 6	40103	06	+/-0.025V

**Table 1.0** Register Setup Values.

<b>Trim Zero Registers and Calibration Values</b>		
<b>Range</b>	<b>Register</b>	<b>Value</b>
+/-10Vdc	40114	0000
+/-5Vdc	40115	0000
+/-1Vdc	40116	0000
+/-0.1Vdc	40117	0000
+/-0.05Vdc	40118	0000
+/-0.025Vdc	40119	0000

**Table 2.0** Trim Zero Registers and Values.

<b>Trim Span Registers and Calibration Values</b>		
<b>Range</b>	<b>Register</b>	<b>Value</b>
+/-0.025Vdc	40151	FFFE
+/-0.05Vdc	40150	FFFE
+/-0.1Vdc	40149	FFFE
+/-1Vdc	40148	FFFE
+/-5Vdc	40147	FFFE
+/-10Vdc	40146	FFFE

**Table 3.0** Trim Span Registers and Values.

## 4.2 D6200 - Seven Channel Current Input Module

### Overview

The D6200 series analog input module contains seven differential analog inputs for measuring current signals such as 4-20mA loops. Each analog input channel can measure current signals up to +/-20mA. Any unused channels can be disabled.

### Analog to Digital Converter

The D6200 series analog input modules contain a 16-bit analog to digital converter to perform the signal conversion to digital information. The analog to digital converter performs a total of 25 conversions per second. Meaning, if all 7 channels were enabled the each channel would be measured 3+ times per second. The conversion rate per channel can be improved by disabling any unused channels.

### Features and Register Assignments

The D6200 series analog input modules contain many user-selectable features. The user can select all features such as baud rate, parity type, analog range selection and digital filtering. The complete list of features is illustrated in the "[Seven Channel Analog Current Input Register Assignments](#)" register map below. The register map format is used for consistency with the Modbus RTU protocol. The register map contains the register numbers in decimal format, register description, acceptable data values, and list of what each value means. These registers can be written to using most any Modbus master program or using the DGH D6000 series utility software.

**Note:** All Modbus Register values in the tables below are represented as "decimal" numbers.

### Factory Initial Values

The D6200 series analog module features are initialized at the factory with a set of "Initial Values". A complete list of factory "[Initial Values](#)" can be found in the table below. For reference purposes, the Modbus Slave address is preset to hex 0x01, the baud rate is 9600, Parity type is None and the Stop Bits is "1".

### Calibration

The D6200 series analog input modules are shipped from the factory as fully calibrated devices. Throughout the lifetime of the module there may be need to verify or adjust the calibration of the device. The verification and adjustment process should only be completed using NIST traceable calibration equipment. A D6200 series [Calibration procedure](#) is included below.

### Connector Pin Designations

The D6200 series module uses two 3.81mm removable plugs for connecting signals to the module. One six-pin connector is for the power supply and the host RS-485 data line connections. A second sixteen-pin connector is used to connect analog input signals to the module. The [pin designations](#) for each connector are printed on the module label and are listed in a table below.

## 4.2.2 Seven Channel Current Input Specifications

### Connections

#### Power & Serial Communications

<u>Pin Number</u>	<u>Pin</u>	<u>Designator</u>
1	GND	- Power Supply
2	+VS	+ Power Supply
3	DATA-	RS-485 Data-
4	DATA+	RS-485 Data+
5	Default*	Default*
6	GND	- Power Supply

#### Analog Input Pin Assignments

<u>Pin Number</u>	<u>Pin</u>	<u>Designator</u>
1	CH1+	CH1 +Input
2	CH1-	CH1 -Input
3	CH2+	CH2 +Input
4	CH2-	CH2 -Input
5	CH3+	CH3 +Input
6	CH3-	CH3 -Input
7	CH4+	CH4 +Input
8	CH4-	CH4 -Input
9	CH5+	CH5 +Input
10	CH5-	CH5 -Input
11	CH6+	CH6 +Input
12	CH6-	CH6 -Input
13	CH7+	CH7 +Input
14	CH7-	CH7 -Input
15	ISO. GND	Isolated GND
16	ISO. GND	Isolated GND

### Specifications

Analog Inputs	7 Channels
Input Range Current	+/-20mA
Differential Reading CH to CH	+/-10Vdc
Protocol Serial	Modbus RTU
Power Supply Voltage Power	+10-30Vdc 1.4W
Connectors Spacing Max Wire Size Max Current	3.81mm 14-24 AWG 8 Amperes
Serial LED Displays Transmit (Top) Receive (Bottom)	TxData RxData



#### 4.2.3 Seven Channel Current Input Module Initial Values

<b>Module Parameter</b>	<b>Value</b>
Slave Address	1
Baud Rate	9600
Parity Type	None
Modbus Response Delay	3mS
Modbus Query Delay	0mS
Conversion Rate	60Hz
Large Signal Filter	0 Seconds
Small Signal Filter	0 Seconds
Channel 0 Range	+/-20mA
Channel 1 Range	+/-20mA
Channel 2 Range	+/-20mA
Channel 3 Range	+/-20mA
Channel 4 Range	+/-20mA
Channel 5 Range	+/-20mA
Channel 6 Range	+/-20mA

#### 4.2.4 Seven Channel Current Input Register Assignments

Register	Description	Functions	Value	Description
40001	Slave Address	R/W	1-DF	Factory set to 0x0001.
40002	UART Setup	R/W		<p><u>Bits 0-4 Baud Rate</u>            5=9600            6=19.2K            7=38.4K            8=57.6K            9=115.2K</p> <p><u>Bits 5-6 Parity</u>            0=No Parity, 8-N-2            1=Odd            2=Even            3=No Parity, 8-N-1</p> <p><b>Factory set to 0x0035 = 9600, 8, N, 1.</b></p>
40003	Modbus Delays	R/W	0-303F	<p><u>Bits 0-7</u>            The Response Delay in milliseconds. This is required when the RS-485 adapter cannot tri-state immediately after the last character is transmitted from the host. Maximum value is 63mS. Factory default value is 3.</p> <p><u>Bits 8-15</u>            The End of Query Delay in milliseconds (48mS max). This is an additional time that the module will wait prior to marking the end of the message. Slower host computers may not be able transmit a continuous message stream, thereby creating gaps between characters exceeding the normal 3.5 character times limit. Factory default value is 0.</p> <p><b>Factory set, 0x0003.</b></p>
40033	Software Version	R		Factory set, Code Version.
40048	Last Converted Chan, Conversion Counter	R	0-06FF	<p><u>Bits 0-7</u>            The counter increments each conversion and rolled over after FF. The Conversion Counter indicates when the data registers have been updated.</p> <p><u>Bits 8-10</u>            Input channel last conversion stored. The information is useful when all channel data is read back with 1 query. The user can identify which channels have been converted since the last query as long as the time between queries is less than 8 conversion times. Initialized to '0x0000' on device reset.</p>
40049	Channel 0 Data	R	0-FFFF	Data - Ch 0, Offset binary, zero=0x8000.
40050	Channel 1 Data	R	0-FFFF	Data - Channel 1
40051	Channel 2 Data	R	0-FFFF	Data - Channel 2
40052	Channel 3 Data	R	0-FFFF	Data - Channel 3
40053	Channel 4 Data	R	0-FFFF	Data - Channel 4
40054	Channel 5 Data	R	0-FFFF	Data - Channel 5
40055	Channel 6 Data	R	0-FFFF	Data - Channel 6

40095	Misc. Setup	R/W	0-1	<p><u>Bit 0</u> – Normal Mode Rejection Setting  0 – 60Hz, 25 Hz Conversion Speed.  1 – 50Hz, 20 Hz Conversion Speed.  <b>Factory set to 0x0000.</b></p>																														
40096	Signal Filtering	R/W	0-3F	<p>This register controls all channels. Time constants are only approximate values.</p> <table> <thead> <tr> <th><u>Bits 0-3</u></th> <th><u>Small Filter Time Constant(Secs)</u></th> </tr> </thead> <tbody> <tr><td>1</td><td>0</td></tr> <tr><td>1</td><td>0.5</td></tr> <tr><td>2</td><td>1</td></tr> <tr><td>3</td><td>2</td></tr> <tr><td>4</td><td>4</td></tr> <tr><td>5</td><td>8</td></tr> <tr><td>6</td><td>16</td></tr> <tr><td>7</td><td>32</td></tr> </tbody> </table> <table> <thead> <tr> <th><u>Bits 4-7</u></th> <th><u>Large Filter Time Constant(Secs)</u></th> </tr> </thead> <tbody> <tr><td>0</td><td>0</td></tr> <tr><td>1</td><td>0.5</td></tr> <tr><td>2</td><td>1</td></tr> <tr><td>3</td><td>2</td></tr> <tr><td>4-7</td><td>Reserved</td></tr> </tbody> </table> <p><b>Factory set to 0x0000.</b></p>	<u>Bits 0-3</u>	<u>Small Filter Time Constant(Secs)</u>	1	0	1	0.5	2	1	3	2	4	4	5	8	6	16	7	32	<u>Bits 4-7</u>	<u>Large Filter Time Constant(Secs)</u>	0	0	1	0.5	2	1	3	2	4-7	Reserved
<u>Bits 0-3</u>	<u>Small Filter Time Constant(Secs)</u>																																	
1	0																																	
1	0.5																																	
2	1																																	
3	2																																	
4	4																																	
5	8																																	
6	16																																	
7	32																																	
<u>Bits 4-7</u>	<u>Large Filter Time Constant(Secs)</u>																																	
0	0																																	
1	0.5																																	
2	1																																	
3	2																																	
4-7	Reserved																																	
40097	Setup Channel 0	R/W	0-F	<p>Channel 0 range. Non-volatile write protected register. If the EEPROM cannot be written because of not being enabled, it replies with a Negative Acknowledge Exception response 07h. Modbus function code 10h is limited to 4 data values.</p> <table> <thead> <tr> <th><u>Range:</u></th> <th><u>Bits 0-7 Hex</u></th> </tr> </thead> <tbody> <tr><td>Disable Channel</td><td>00</td></tr> <tr><td>+/-20mA</td><td>03</td></tr> </tbody> </table> <p><b>Factory set to 0x0003.</b></p>	<u>Range:</u>	<u>Bits 0-7 Hex</u>	Disable Channel	00	+/-20mA	03																								
<u>Range:</u>	<u>Bits 0-7 Hex</u>																																	
Disable Channel	00																																	
+/-20mA	03																																	
40098	Setup Channel 1	R/W	0-F	<p>Holds Channel 1 range.  <b>Factory set to 0x0003.</b></p>																														
40099	Setup Channel 2	R/W	0-F	<p>Holds Channel 2 range.  <b>Factory set to 0x0003.</b></p>																														
40100	Setup Channel 3	R/W	0-F	<p>Holds Channel 3 range.  <b>Factory set to 0x0003.</b></p>																														
40101	Setup Channel 4	R/W	0-F	<p>Holds Channel 4 range.  <b>Factory set to 0x0003.</b></p>																														
40102	Setup Channel 5	R/W	0-F	<p>Holds Channel 5 range.  <b>Factory set to 0x0003.</b></p>																														
40103	Setup Channel 6	R/W	0-F	<p>Holds Channel 6 range.  <b>Factory set to 0x0003.</b></p>																														
40116	Trim Zero, +/-20mA Range	WP	0	<p>Force all channel data to 0x8000, input signal = 0. Wait 15 Secs, Write 0x0000.</p>																														
40148	Trim FS, +/-20mA Range	WP	D000-FFFE	<p>Force all channel data to top of range, Wait 15 Sec, Write value (0xffff if +F.S.).</p>																														
<b>40241</b>	<b>Control Register</b>	W		<p><b>0</b> – Normal operation (NOP)  <b>1</b> – Remote Reset (write protected)  <b>2</b> – Write Enable  <b>5</b> – Initialize Host Communication setup</p>																														

**Functions:**

R     Read Only  
R/W    Read/Write  
WP     Write-Protected

## 4.2.5 Seven Channel Current Input Calibration Procedure

### Required Equipment:

1. Computer running the DGH Utility Software or another Modbus Master program.
2. A NIST traceable DC Current Standard with +/-20mA range.

### Setup Steps – Perform Calibration Steps in Order Listed:

1. Allow unit to warm up for 15 minutes.
2. Connect the positive lead of DC current calibrator to Ch1 +Input terminal.
3. Connect the Ch1 –Input terminal the Ch2 +Input terminal.
4. Connect the Ch2 –Input terminal the Ch3 +Input terminal.
5. Connect the Ch3 –Input terminal the Ch4 +Input terminal.
6. Connect the Ch4 –Input terminal the Ch5 +Input terminal.
7. Connect the Ch5 –Input terminal the Ch6 +Input terminal.
8. Connect the Ch6 –Input terminal the Ch7 +Input terminal.
9. Connect the negative lead of the DC current calibrator to Ch7 –Input terminal.
10. Install the DGH Utility Software or another Modbus Master Program to communicate with, and calibrate with the module via serial port or a TCP/IP connection.
11. Using the DGH Utility Software configure all channels for the +/-20mA range using the data values in Table 1.0 below.

### Trim Zero:

1. Set the DC calibrator current output to +0.00mA. Wait 30 seconds.
2. Trim Zero on all channels.
  - a. Write a value of 0x0002h to Control Register 40241 to Write-Enable the module.
  - b. Trim Zero on all seven channels by writing a value of 0x0000h to Trim Zero register 40116. See Table 2.0 below.

### Trim Span:

1. Set the DC calibrator current output to +20.000mA. Wait 30 seconds.
2. Trim Span on all channels.
  - a. Write a value of 0x0002h to Control Register 40241 to Write-Enable the module.
  - b. Trim Span on all seven channels by writing a value of 0xfffe to Trim Span register 40148. See Table 3.0 below.

#### 4.2.6 Seven Channel Current Input Calibration Tables:

<b><u>Seven Channel Current Register Values</u></b>		
<b><u>Channel</u></b>	<b><u>Range Control</u></b>	<b><u>Range Values</u></b>
Channel 0	40097	0 = Disabled 3 = +/-20mA
Channel 1	40098	
Channel 2	40099	
Channel 3	40100	
Channel 4	40101	
Channel 5	40102	
Channel 6	40103	

**Table 1.0** Register Setup Values.

<b><u>Trim Zero Register and Calibration Value</u></b>		
<b><u>Range</u></b>	<b><u>Register</u></b>	<b><u>Value</u></b>
+/-20mA	40116	0000

**Table 2.0** Trim Zero Register and Value.

<b><u>Trim Span Register and Calibration Value</u></b>		
<b><u>Range</u></b>	<b><u>Register</u></b>	<b><u>Value</u></b>
+/-20mA	40148	FFFE

**Table 3.0** Trim Span Register and Value.

## 4.3 D6300 - Seven Channel Thermocouple Input Module

### Overview

The D6300 series analog input module contains seven differential inputs for measuring thermocouple signals. Each analog input channel is user programmable and may be assigned to measure one of 8 different thermocouple types. The D6300 can measure thermocouple types J, K, T, E, R, S, B and C. Any unused channels can be disabled.

### Analog to Digital Converter

The D6300 series analog input modules contain a 16-bit analog to digital converter to perform the signal conversion to digital information. The analog to digital converter performs a total of 25 conversions per second. Meaning, if all 7 channels were enabled the each channel would be measured 3+ times per second. The conversion rate per channel can be improved by disabling any unused channels.

### Features and Register Assignments

The D6300 series analog input modules contain many user-selectable features. The user can select all features such as baud rate, parity type, analog range selection and digital filtering. The complete list of features is illustrated in the "[Seven Channel Analog Thermocouple Input Register Assignments](#)" register map below. The register map format is used for consistency with the Modbus RTU protocol. The register map contains the register numbers in decimal format, register description, acceptable data values, and list of what each value means. These registers can be written to using most any Modbus master program or using the DGH D6000 series utility software.

**Note:** All Modbus Register values in the tables below are represented as "decimal" numbers.

### Factory Initial Values

The D6300 series analog module features are initialized at the factory with a set of "Initial Values". A complete list of factory "[Initial Values](#)" can be found in the table below. For reference purposes, the Modbus Slave address is preset to hex 0x01, the baud rate is 9600, Parity type is None and the Stop Bits is "1".

### Calibration

The D6300 series analog input modules are shipped from the factory as fully calibrated devices. Throughout the lifetime of the module there may be need to verify or adjust the calibration of the device. The verification and adjustment process should only be completed using NIST traceable calibration equipment. A D6300 series [Calibration procedure](#) is included below.

### Connector Pin Designations

The D6300 series module uses two 3.81mm removable plugs for connecting signals to the module. One six-pin connector is for the power supply and the host RS-485 data line connections. A second sixteen-pin connector is used to connect analog input signals to the module. The [pin designations](#) for each connector are printed on the module label and are listed in a table below.

### 4.3.2 Seven Channel Thermocouple Input Specifications

#### Connections

#### Power & Serial Communications

<u>Pin Number</u>	<u>Pin</u>	<u>Designator</u>
1	GND	- Power Supply
2	+VS	+ Power Supply
3	DATA-	RS-485 Data-
4	DATA+	RS-485 Data+
5	Default*	Default*
6	GND	- Power Supply

#### Analog Input Pin Assignments

<u>Pin Number</u>	<u>Pin</u>	<u>Designator</u>
1	CH1+	CH1 +Input
2	CH1-	CH1 -Input
3	CH2+	CH2 +Input
4	CH2-	CH2 -Input
5	CH3+	CH3 +Input
6	CH3-	CH3 -Input
7	CH4+	CH4 +Input
8	CH4-	CH4 -Input
9	CH5+	CH5 +Input
10	CH5-	CH5 -Input
11	CH6+	CH6 +Input
12	CH6-	CH6 -Input
13	CH7+	CH7 +Input
14	CH7-	CH7 -Input
15	ISO. GND	Isolated GND
16	ISO. GND	Isolated GND

#### Specifications

Analog Inputs	7 Channels
Input Type	Thermocouple
Differential Reading	J,K,T,E,R,S,B,C
CH to CH	+/-10Vdc
Protocol	Modbus RTU
Serial	
Power Supply	
Voltage	+10-30Vdc
Power	1.4W
Connectors	
Spacing	3.81mm
Max Wire Size	14-24 AWG
Max Current	8 Amperes
Serial LED Displays	
Transmit (Top)	TxData
Receive (Bottom)	RxData

### 4.3.3 Seven Channel Thermocouple Input Module Initial Values

<b>Module Parameter</b>	<b>Value</b>
Slave Address	1
Baud Rate	9600
Parity Type	None
Modbus Response Delay	3mS
Modbus Query Delay	0mS
Conversion Rate	60Hz
Large Signal Filter	0 Seconds
Small Signal Filter	0 Seconds
Channel 0 Range	J-Tc Type
Channel 1 Range	J-Tc Type
Channel 2 Range	J-Tc Type
Channel 3 Range	J-Tc Type
Channel 4 Range	J-Tc Type
Channel 5 Range	J-Tc Type
Channel 6 Range	J-Tc Type



### 4.3.4 Seven Channel Thermocouple Input Register Assignments

Register	Description	Functions	Value	Description
40001	Slave Address	R/W	1-DF	Factory set to 0x0001.
40002	UART Setup	R/W		<p><u>Bits 0-4 Baud Rate</u>                      5=9600                      6=19.2K                      7=38.4K                      8=57.6K                      9=115.2K</p> <p><u>Bits 5-6 Parity</u>                      0=No Parity, 8-N-2                      1=Odd                      2=Even                      3=No Parity, 8-N-1</p> <p><b>Factory set to 0x0035 = 9600, 8, N, 1.</b></p>
40003	Modbus Delays	R/W	0-303F	<p><u>Bits 0-7</u>                      The Response Delay in milliseconds. This is required when the RS-485 adapter cannot tri-state immediately after the last character is transmitted from the host. Maximum value is 63mS. Factory default value is 3.</p> <p><u>Bits 8-15</u>                      The End of Query Delay in milliseconds (48mS max). This is an additional time that the module will wait prior to marking the end of the message. Slower host computers may not be able transmit a continuous message stream, thereby creating gaps between characters exceeding the normal 3.5 character times limit. Factory default value is 0.</p> <p><b>Factory set, 0x0003.</b></p>
40033	Software Version	R		Factory set, Code Version.
40048	Last Converted Chan, Conversion Counter	R	0-06FF	<p><u>Bits 0-7</u>                      The counter increments each conversion and rolled over after FF. The Conversion Counter indicates when the data registers have been updated.</p> <p><u>Bits 8-10</u>                      Input channel last conversion stored. The information is useful when all channel data is read back with 1 query. The user can identify which channels have been converted since the last query as long as the time between queries is less than 8 conversion times. Initialized to '0x0000' on device reset.</p>
40049	Channel 0 Data	R	0-FFFF	Data - Ch 0, Offset binary, zero=0x8000.
40050	Channel 1 Data	R	0-FFFF	Data - Channel 1
40051	Channel 2 Data	R	0-FFFF	Data - Channel 2
40052	Channel 3 Data	R	0-FFFF	Data - Channel 3
40053	Channel 4 Data	R	0-FFFF	Data - Channel 4
40054	Channel 5 Data	R	0-FFFF	Data - Channel 5
40055	Channel 6 Data	R	0-FFFF	Data - Channel 6

40095	Misc. Setup	R/W	0-1	<p><u>Bit 0</u> – Normal Mode Rejection Setting  0 – 60Hz, 25 Hz Conversion Speed.  1 – 50Hz, 20 Hz Conversion Speed.  <b>Factory set to 0x0000.</b></p>																														
40096	Signal Filtering	R/W	0-3F	<p>This register controls all channels. Time constants are only approximate values.</p> <table> <tr> <td><u>Bits 0-3</u></td> <td><u>Small Filter Time Constant(Secs)</u></td> </tr> <tr> <td>2</td> <td>0</td> </tr> <tr> <td>1</td> <td>0.5</td> </tr> <tr> <td>2</td> <td>1</td> </tr> <tr> <td>3</td> <td>2</td> </tr> <tr> <td>4</td> <td>4</td> </tr> <tr> <td>5</td> <td>8</td> </tr> <tr> <td>6</td> <td>16</td> </tr> <tr> <td>7</td> <td>32</td> </tr> </table> <table> <tr> <td><u>Bits 4-7</u></td> <td><u>Large Filter Time Constant(Secs)</u></td> </tr> <tr> <td>0</td> <td>0</td> </tr> <tr> <td>1</td> <td>0.5</td> </tr> <tr> <td>2</td> <td>1</td> </tr> <tr> <td>3</td> <td>2</td> </tr> <tr> <td>4-7</td> <td>Reserved</td> </tr> </table> <p><b>Factory set to 0x0000.</b></p>	<u>Bits 0-3</u>	<u>Small Filter Time Constant(Secs)</u>	2	0	1	0.5	2	1	3	2	4	4	5	8	6	16	7	32	<u>Bits 4-7</u>	<u>Large Filter Time Constant(Secs)</u>	0	0	1	0.5	2	1	3	2	4-7	Reserved
<u>Bits 0-3</u>	<u>Small Filter Time Constant(Secs)</u>																																	
2	0																																	
1	0.5																																	
2	1																																	
3	2																																	
4	4																																	
5	8																																	
6	16																																	
7	32																																	
<u>Bits 4-7</u>	<u>Large Filter Time Constant(Secs)</u>																																	
0	0																																	
1	0.5																																	
2	1																																	
3	2																																	
4-7	Reserved																																	
40097	Setup Channel 0	R/W	0-F	<p>Channel 0 range. Non-volatile write protected register. If the EEPROM cannot be written because of not being enabled, it replies with a Negative Acknowledge Exception response 07h. Modbus function code 10h is limited to 4 data values.</p> <table> <tr> <td><u>Range:</u></td> <td><u>Bits 0-7 Hex</u></td> </tr> <tr> <td>Disable Channel</td> <td>00</td> </tr> <tr> <td>J-Tc (-200-760C)</td> <td>21</td> </tr> <tr> <td>K-Tc (-150-1250C)</td> <td>22</td> </tr> <tr> <td>T-Tc (-200-400C)</td> <td>23</td> </tr> <tr> <td>E-Tc (-100-1000C)</td> <td>24</td> </tr> <tr> <td>R-Tc (+0-1750C)</td> <td>25</td> </tr> <tr> <td>S-Tc (+0-1750C)</td> <td>26</td> </tr> <tr> <td>B-Tc (+0-1820C)</td> <td>27</td> </tr> <tr> <td>C-Tc (+0-2315C)</td> <td>28</td> </tr> </table> <p><b>Factory set to 0x0003.</b></p>	<u>Range:</u>	<u>Bits 0-7 Hex</u>	Disable Channel	00	J-Tc (-200-760C)	21	K-Tc (-150-1250C)	22	T-Tc (-200-400C)	23	E-Tc (-100-1000C)	24	R-Tc (+0-1750C)	25	S-Tc (+0-1750C)	26	B-Tc (+0-1820C)	27	C-Tc (+0-2315C)	28										
<u>Range:</u>	<u>Bits 0-7 Hex</u>																																	
Disable Channel	00																																	
J-Tc (-200-760C)	21																																	
K-Tc (-150-1250C)	22																																	
T-Tc (-200-400C)	23																																	
E-Tc (-100-1000C)	24																																	
R-Tc (+0-1750C)	25																																	
S-Tc (+0-1750C)	26																																	
B-Tc (+0-1820C)	27																																	
C-Tc (+0-2315C)	28																																	
40098	Setup Channel 1	R/W	0-F	<p>Holds Channel 1 range.  <b>Factory set to 0x0003.</b></p>																														
40099	Setup Channel 2	R/W	0-F	<p>Holds Channel 2 range.  <b>Factory set to 0x0003.</b></p>																														
40100	Setup Channel 3	R/W	0-F	<p>Holds Channel 3 range.  <b>Factory set to 0x0003.</b></p>																														
40101	Setup Channel 4	R/W	0-F	<p>Holds Channel 4 range.  <b>Factory set to 0x0003.</b></p>																														
40102	Setup Channel 5	R/W	0-F	<p>Holds Channel 5 range.  <b>Factory set to 0x0003.</b></p>																														
40103	Setup Channel 6	R/W	0-F	<p>Holds Channel 6 range.  <b>Factory set to 0x0003.</b></p>																														
40116	Trim Zero, +/-20mA Range	WP	0	<p>Force all channel data to 0x8000, input signal = 0. Wait 15 Secs, Write 0x0000.</p>																														
40148	Trim FS, +/-20mA Range	WP	D000-FFFE	<p>Force all channel data to top of range, Wait 15 Sec, Write value (0xffff if +F.S.).</p>																														
40241	<b>Control Register</b>	W		<p><b>0</b> – Normal operation (NOP)  <b>1</b> – Remote Reset (write protected)  <b>2</b> – Write Enable  <b>5</b> – Initialize Host Communication setup</p>																														

### 4.3.5 Seven Channel Thermocouple Input Calibration Procedure

#### Required Equipment:

1. Computer running the DGH Utility Software or another Modbus Master program.
2. A NIST traceable DC Voltage Standard.

#### Setup Steps – Perform Calibration Steps in Order Listed:

1. Allow unit to warm up for 15 minutes.
2. Connect the positive lead of DC current calibrator to Ch1 +Input terminal.
3. Connect the Ch1 –Input terminal the Ch2 +Input terminal.
4. Connect the Ch2 –Input terminal the Ch3 +Input terminal.
5. Connect the Ch3 –Input terminal the Ch4 +Input terminal.
6. Connect the Ch4 –Input terminal the Ch5 +Input terminal.
7. Connect the Ch5 –Input terminal the Ch6+Input terminal.
8. Connect the Ch6 –Input terminal the Ch7 +Input terminal.
9. Connect the negative lead of the DC current calibrator to Ch7 –Input terminal.
10. Install the DGH Utility Software or another Modbus Master Program to communicate with, and calibrate with the module via serial port or a TCP/IP connection.
11. Using the DGH Utility Software configure all channels for the +/-20mA range using the data values in Table 1.0 below.

#### Trim Zero:

1. Set the DC calibrator current output to +0.00mV. Wait 30 seconds.
2. Trim Zero on all channels.
  - a. Write a value of 0x0002h to Control Register 40241 to Write-Enable the module.
  - b. Trim Zero on all seven channels by writing a value of 0x0000h to Trim Zero register 40116. See Table 2.0 below.

#### Trim Span:

1. Set the DC calibrator current output to +20.000mA. Wait 30 seconds.
2. Trim Span on all channels.
  - a. Write a value of 0x0002h to Control Register 40241 to Write-Enable the module.
  - b. Trim Span on all seven channels by writing a value of 0xfffe to Trim Span register 40148. See Table 3.0 below.

#### Trim CJC's:

1. Set the input signal to -----.
2. Set all module channels to the J-Thermocouple range.
3. Use the DGH Utility Software or a Modbus Master program to perform steps #4 & #5.
4. Trim Zero on each input channel
  - a. Write a value of 0x0002h to Control Register 40241 to Write-Enable the module.
  - b. Write a value of 0x0000h to register 40114.
5. Apply input signal to each channel from Table x.xx.
  - a. Wait 1 minute.
  - b. Write a value of 0x0002h to Control Register 40241 to Write-Enable the module.
  - c. Write a value of 0xfffe

### Trim Thermocouples:

1. Set the input signal to -----.
2. Set all module channels to the J-Thermocouple range.
3. Use the DGH Utility Software or a Modbus Master program to perform steps #4 & #5.
4. Trim Zero on each input channel
  - a. Write a value of 0x0002h to Control Register 40241 to Write-Enable the module.
  - b. Write a value of 0x0000h to register 40114.
5. Apply input signal to each channel from Table x.xx.
  - a. Wait 1 minute.
  - b. Write a value of 0x0002h to Control Register 40241 to Write-Enable the module.
  - c. Write a value of 0xfffe

#### 4.3.5 Seven Channel Thermocouple Input Calibration Tables:

<b>Seven Channel Range Register Values</b>			
<b>Channel</b>	<b>Range Control</b>	<b>Range Values</b>	
Channel 0	40097	00	Disabled
Channel 1	40098	04	+/-0.1V
Channel 2	40099	05	+/-0.05V
Channel 3	40100	06	+/-0.025V
Channel 4	40101	21	J-Type TC
Channel 5	40102	22	K-Type TC
Channel 6	40103	23	T-Type TC
		24	E-Type TC
		25	R-Type TC
		26	S-Type TC
		27	B-Type TC
		28	C-Type TC

**Table 1.0** Register Setup Values.

<b>Trim Zero Registers and Calibration Values</b>		
<b>Range</b>	<b>Register</b>	<b>Value</b>
+/-10Vdc	40114	0000
+/-5Vdc	40115	0000
+/-1Vdc	40116	0000
+/-0.1Vdc	40117	0000
+/-0.05Vdc	40118	0000
+/-0.025Vdc	40119	0000

**Table 2.0** Trim Zero Registers and Values.

<b>Trim Span Registers and Calibration Values</b>		
<b>Range</b>	<b>Register</b>	<b>Value</b>
+/-0.025Vdc	40151	FFFE
+/-0.05Vdc	40150	FFFE
+/-0.1Vdc	40149	FFFE
+/-1Vdc	40148	FFFE
+/-5Vdc	40147	FFFE
+/-10Vdc	40146	FFFE

**Table 3.0** Trim Span Registers and Values.

<b>CJC Calibration Registers and Values</b>			
<b>Channels</b>	<b>Register</b>	<b>Increase Value</b>	<b>Decrease Value</b>
0..3	40129	0001	0000
4..6	40130	0001	0000

**Table 4.0** Trim CJC Registers and Values.

## 4.4 D6400 - Seven Channel Voltage, Thermocouple, Current Input Module

### Overview

The D6400 series analog input module contains seven analog inputs for measuring voltages, thermocouples and current. Each analog input channel is user programmable and may be assigned to different input types.

When measuring voltages or thermocouples, simply use the Utility Software to select the type of signal and range. When configuring any channel to measure current loops or 4-20mA signals then the Input range can be set to either the +/-1Vdc or +/-20mA selections. The module uses the +/-1Vdc range to measure current up to 20mA.

When measuring current signals then a measurement sense resistor must be enabled via jumpers inside the module. Each channel has a jumper strip that must be shorted using a provided shorting bar to enable the sense resistor. The sense resistor is internally connected directly across the channel+ and channel- input pins. See the D6400 board layout below for instructions on taking the module and enabling the jumpers.

### Analog to Digital Converter

The D6400 series analog input modules contain a 16-bit analog to digital converter to perform the signal conversion to digital information. The analog to digital converter performs a total of 25 conversions per second. Meaning, if all 7 channels were enabled the each channel would be measured 3+ times per second. The conversion rate per channel can be improved by disabling any unused channels.

### Features and Register Assignments

The D6400 series analog input modules contain many user-selectable features. The user can select all features such as baud rate, parity type, analog range selection and digital filtering. The complete list of features is illustrated in the [“Seven Channel Voltage, Thermocouple and Current Input Register Assignments”](#) register map below. The register map format is used for consistency with the Modbus RTU protocol. The register map contains the register numbers in decimal format, register description, acceptable data values, and list of what each value means. These registers can be written to using most any Modbus master program or using the DGH D6000 series utility software.

**Note:** All Modbus Register values in the tables below are represented as “decimal” numbers.

### Factory Initial Values

The D6400 series analog module features are initialized at the factory with a set of “Initial Values”. A complete list of factory [“Initial Values”](#) can be found in the table below. For reference purposes, the Modbus Slave address is preset to hex 0x01, the baud rate is 9600, Parity type is None and the Stop Bits is “1”.

### Calibration

The D6400 series analog input modules are shipped from the factory as fully calibrated devices. Throughout the lifetime of the module there may be need to verify or adjust the calibration of the device. The verification and adjustment process should only be completed using NIST traceable calibration equipment. A D6400 series [Calibration procedure](#) is included below.

### Connector Pin Designations

The D6400 series module uses two 3.81mm removable plugs for connecting signals to the module. One six-pin connector is for the power supply and the host RS-485 data line connections. A second sixteen-pin connector is used to connect analog input signals to the module. The [pin designations](#) for each connector are printed on the module label and are listed in a table below.

#### 4.4.1 Seven Channel Voltage, Thermocouple, Current Input Pin Assignments and Specifications

##### Connections

##### Power & Serial Communications

<u>Pin Number</u>	<u>Pin</u>	<u>Designator</u>
1	GND	- Power Supply
2	+VS	+ Power Supply
3	Data-	RS-485 Data-
4	Data+	RS-485 Data+
5	Default*	Default*
6	GND	- Power Supply

##### Analog Input Pin Assignments

<u>Pin Number</u>	<u>Pin</u>	<u>Designator</u>
1	CH1+	CH1 +Input
2	CH1-	CH1 -Input
3	CH2+	CH2 +Input
4	CH2-	CH2 -Input
5	CH3+	CH3 +Input
6	CH3-	CH3 -Input
7	CH4+	CH4 +Input
8	CH4-	CH4 -Input
9	CH5+	CH5 +Input
10	CH5-	CH5 -Input
11	CH6+	CH6 +Input
12	CH6-	CH6 -Input
13	CH7+	CH7 +Input
14	CH7-	CH7 -Input
15	ISO. GND	Isolated GND
16	ISO. GND	Isolated GND

##### Specifications

Analog Inputs	7 Channels
User Selectable Input Ranges	
Bipolar Voltage	10V, 5V, 1V, 0.1V, 0.05V, 0.025V
Thermocouple	J,K,T,E,R,S,B,C
Current	+/-20mA
Differential Reading	CH to CH
Protocol	
Serial	Modbus RTU
Power Supply	
Voltage	+10-30Vdc
Power	1.4W
Connectors	
Spacing	3.81mm
Max Wire Size	14-24 AWG
Max Current	8 Amperes
Serial LED Displays	
Transmit (Top)	Serial TxData
Receive (Bottom)	Serial RxData

#### 4.4.2 Seven Channel Voltage, Thermocouple and Current Input Initial Values

<b>Module Parameter</b>	<b>Value</b>
Slave Address	1
Baud Rate	9600
Parity Type	None
Modbus Response Delay	3mS
Modbus Query Delay	0mS
Conversion Rate	60Hz
Large Signal Filter	0 Seconds
Small Signal Filter	0 Seconds
Channel 1 Range	+/-10Vdc
Channel 2 Range	+/-10Vdc
Channel 3 Range	+/-10Vdc
Channel 4 Range	+/-10Vdc
Channel 5 Range	+/-10Vdc
Channel 6 Range	+/-10Vdc
Channel 7 Range	+/-10Vdc



#### 4.4.3 Seven Channel Voltage, Thermocouple and Current Input Register Assignments

Register	Description	Functions	Value	Description
40001	Slave Address	R/W	1-DF	Factory set to 0x0001.
40002	UART Setup	R/W		<p><u>Bits 0-4 Baud Rate</u>                      5=9600                      6=19.2K                      7=38.4K                      8=57.6K                      9=115.2K</p> <p><u>Bits 5-6 Parity</u>                      0=No Parity, 8-N-2                      1=Odd                      2=Even                      3=No Parity, 8-N-1</p> <p><b>Factory set to 0x0035 = 9600, 8, N, 1.</b></p>
40003	Modbus Delays	R/W	0-303F	<p><u>Bits 0-7</u>                      The Response Delay in milliseconds. This is required when the RS-485 adapter cannot tri-state immediately after the last character is transmitted from the host. Maximum value is 63mS. Factory default value is 3.</p> <p><u>Bits 8-15</u>                      The End of Query Delay in milliseconds (48mS max). This is an additional time that the module will wait prior to marking the end of the message. Slower host computers may not be able transmit a continuous message stream, thereby creating gaps between characters exceeding the normal 3.5 character times limit. Factory default value is 0.</p> <p><b>Factory set, 0x0003.</b></p>
40033	Software Version	R		Factory set, Code Version.
40048	Last Converted Chan, Conversion Counter	R	0-06FF	<p><u>Bits 0-7</u>                      The counter increments each conversion and rolled over after FF. The Conversion Counter indicates when the data registers have been updated.</p> <p><u>Bits 8-10</u>                      Input channel last conversion stored. The information is useful when all channel data is read back with 1 query. The user can identify which channels have been converted since the last query as long as the time between queries is less than 8 conversion times. Initialized to '0x0000' on device reset.</p>
40049	Channel 1 Data	R	0-FFFF	Data - Ch 1, Offset binary, zero=0x8000.
40050	Channel 2 Data	R	0-FFFF	Data - Channel 2
40051	Channel 3 Data	R	0-FFFF	Data - Channel 3
40052	Channel 4 Data	R	0-FFFF	Data - Channel 4
40053	Channel 5 Data	R	0-FFFF	Data - Channel 5
40054	Channel 6 Data	R	0-FFFF	Data - Channel 6
40055	Channel 7 Data	R	0-FFFF	Data - Channel 7

40095	Misc. Setup	R/W	0-1	<p><b>Bit 0</b> – Normal Mode Rejection Setting  0 – 60Hz, 25 Hz Conversion Speed.  1 – 50Hz, 20 Hz Conversion Speed.  <b>Factory set to 0x0000.</b></p>																																		
40096	Signal Filtering	R/W	0-3F	<p>This register controls all channels. Time constants are only approximate values.  <b>Bits 0-3</b>    <u>Small Filter Time Constant(Secs)</u></p> <table> <tr><td>3</td><td>0</td></tr> <tr><td>1</td><td>0.5</td></tr> <tr><td>2</td><td>1</td></tr> <tr><td>3</td><td>2</td></tr> <tr><td>4</td><td>4</td></tr> <tr><td>5</td><td>8</td></tr> <tr><td>6</td><td>16</td></tr> <tr><td>7</td><td>32</td></tr> </table> <p><b>Bits 4-7</b>    <u>Large Filter Time Constant(Secs)</u></p> <table> <tr><td>0</td><td>0</td></tr> <tr><td>1</td><td>0.5</td></tr> <tr><td>2</td><td>1</td></tr> <tr><td>3</td><td>2</td></tr> <tr><td>4-7</td><td>Reserved</td></tr> </table> <p><b>Factory set to 0x0000.</b></p>	3	0	1	0.5	2	1	3	2	4	4	5	8	6	16	7	32	0	0	1	0.5	2	1	3	2	4-7	Reserved								
3	0																																					
1	0.5																																					
2	1																																					
3	2																																					
4	4																																					
5	8																																					
6	16																																					
7	32																																					
0	0																																					
1	0.5																																					
2	1																																					
3	2																																					
4-7	Reserved																																					
40097	Setup Channel 1	R/W	0-F	<p>Channel 1 range. Non-volatile write protected register. If the EEPROM cannot be written because of not being enabled, it replies with a Negative Acknowledge Exception response 07h. Modbus function code 10h is limited to 4 data values.</p> <table> <thead> <tr> <th><u>Range:</u></th> <th><u>Bits 0-7 Hex</u></th> </tr> </thead> <tbody> <tr><td>Disable Channel</td><td>00</td></tr> <tr><td>+/-10V</td><td>01</td></tr> <tr><td>+/-5V</td><td>02</td></tr> <tr><td>+/-1V</td><td>03</td></tr> <tr><td>+/-0.100V</td><td>04</td></tr> <tr><td>+/-0.050V</td><td>05</td></tr> <tr><td>+/-0.025V</td><td>06</td></tr> <tr><td>J-Tc (-200-760C)</td><td>21</td></tr> <tr><td>K-Tc (-150-1250C)</td><td>22</td></tr> <tr><td>T-Tc (-200-400C)</td><td>23</td></tr> <tr><td>E-Tc (-100-1000C)</td><td>24</td></tr> <tr><td>R-Tc (+0-1750C)</td><td>25</td></tr> <tr><td>S-Tc (+0-1750C)</td><td>26</td></tr> <tr><td>B-Tc (+0-1820C)</td><td>27</td></tr> <tr><td>C-Tc (+0-2315C)</td><td>28</td></tr> <tr><td>+/-20mA Current</td><td>03 (Special)</td></tr> </tbody> </table> <p><b>Factory set to 0x0001.</b></p>	<u>Range:</u>	<u>Bits 0-7 Hex</u>	Disable Channel	00	+/-10V	01	+/-5V	02	+/-1V	03	+/-0.100V	04	+/-0.050V	05	+/-0.025V	06	J-Tc (-200-760C)	21	K-Tc (-150-1250C)	22	T-Tc (-200-400C)	23	E-Tc (-100-1000C)	24	R-Tc (+0-1750C)	25	S-Tc (+0-1750C)	26	B-Tc (+0-1820C)	27	C-Tc (+0-2315C)	28	+/-20mA Current	03 (Special)
<u>Range:</u>	<u>Bits 0-7 Hex</u>																																					
Disable Channel	00																																					
+/-10V	01																																					
+/-5V	02																																					
+/-1V	03																																					
+/-0.100V	04																																					
+/-0.050V	05																																					
+/-0.025V	06																																					
J-Tc (-200-760C)	21																																					
K-Tc (-150-1250C)	22																																					
T-Tc (-200-400C)	23																																					
E-Tc (-100-1000C)	24																																					
R-Tc (+0-1750C)	25																																					
S-Tc (+0-1750C)	26																																					
B-Tc (+0-1820C)	27																																					
C-Tc (+0-2315C)	28																																					
+/-20mA Current	03 (Special)																																					
40098	Setup Channel 2	R/W	0-F	<p>Holds Channel 2 range.  <b>Factory set to 0x0001.</b></p>																																		
40099	Setup Channel 3	R/W	0-F	<p>Holds Channel 3 range.  <b>Factory set to 0x0001.</b></p>																																		
40100	Setup Channel 4	R/W	0-F	<p>Holds Channel 4 range.  <b>Factory set to 0x0001.</b></p>																																		
40101	Setup Channel 5	R/W	0-F	<p>Holds Channel 5 range.  <b>Factory set to 0x0001.</b></p>																																		
40102	Setup Channel 6	R/W	0-F	<p>Holds Channel 6 range.  <b>Factory set to 0x0001.</b></p>																																		
40103	Setup Channel 7	R/W	0-F	<p>Holds Channel 7 range.  <b>Factory set to 0x0001.</b></p>																																		
40114	Trim Zero, 10V Range	WP	0	<p>Forces all Channel Data Registers to 8000h, with input signal equal to zero. Apply</p>																																		

				calibration signal at least 15 seconds prior to calibrating to all channels. Calibration Acknowledge Exception Response. Calibration takes 20 seconds.
40115	Trim Zero, 5V Range	WP	0	Refer to Modbus register 40072.
40116	Trim Zero, 1V Range	WP	0	Refer to Modbus register 40072.
40117	Trim Zero, 0.1V Range	WP	0	Refer to Modbus register 40072. Apply calibration signal at least 1 minute prior to calibrating to all channels.
40118	Trim Zero, 0.05V Range	WP	0	Refer to Modbus register 40072. Apply calibration signal at least 1 minute prior to calibrating to all channels.
40119	Trim Zero, 0.025V Range	WP	0	Refer to Modbus register 40072. Apply calibration signal at least 1 minute prior to calibrating to all channels.
40129	Trim CJC 0	WP	0-1	Pre-calibrate appropriate mV range. Attach thermocouple to channel 1, with measurement end in ice bath. Writing a 1 will increase Modbus TC output. Writing a 0 will decrease Modbus TC output. No Trim for R, S, B, C Types.
40130	Trim CJC 1	WP	0-1	Pre-calibrate appropriate mV range. Attach thermocouple to channel 5, with measurement end in ice bath. Writing a 1 will increase Modbus TC output. Writing a 0 will decrease Modbus TC output. No Trim for R, S, B, C Types.
40146	Trim FS, 10V Range	WP	D000-FFFE	Forces all Channel Data Registers to written value, with appropriate input signal. Apply calibration signal at least 15 seconds prior to calibrating to all channels. Acknowledge Exception Response. Calibration takes 20 seconds. See note 1.
40147	Trim FS, 5V Range	WP	D000-FFFE	See Modbus Register 40146.
40148	Trim FS, 1V Range	WP	D000-FFFE	See Modbus Register 40146.
40149	Trim FS, 0.1V Range	WP	D000-FFFE	See Modbus Register 40146. Apply calibration signal at least 1 minute prior to calibrating to all channels.
40150	Trim FS, 0.05V Range	WP	D000-FFFE	See Modbus Register 40146. Apply calibration signal at least 1 minute prior to calibrating to all channels.
40151	Trim FS, 0.025V Range	WP	D000-FFFE	See Modbus Register 40146. Apply calibration signal at least 1 minute prior to calibrating to all channels.
<b>40241</b>	<b>Control Register</b>	<b>W</b>		<b>0</b> – Normal operation (NOP) <b>1</b> – Remote Reset (write protected) <b>2</b> – Write Enable <b>5</b> – Initialize Host Communication setup

**Functions:**

R Read Only  
R/W Read/Write  
WP Write-Protected

#### 4.4.4 Seven Channel Voltage, Thermocouple and Current Input Calibration Procedure

##### Required Equipment:

1. Computer running the DGH Utility Software or another Modbus Master program.
2. A NIST traceable DC Voltage Standard with +/-10Vdc range.

##### Setup Steps – Perform Calibration Steps in Order Listed:

1. Allow unit to warm up for 15 minutes.
2. Short all the +Input pins together using short jumper wires.
3. Short all the -Input pins together using short jumper wires.
4. Connect the +Input wires to the Positive terminal on the DC voltage calibrator.
5. Connect the -Input wires to the Negative terminal on the DC voltage calibrator.
6. Install the DGH Utility Software or another Modbus Master Program to communicate with, and calibrate with the module via serial port or a TCP/IP connection.

##### Trim Zero:

1. Set the DC calibrator voltage output to +0.0000Vdc.
2. Use the DGH Utility Software or a Modbus Master program to perform steps #3 & #5.
3. Set all channels to the same range. Start with +/-10Vdc range, work downward as per values in Table 1.0.
4. Trim Zero on all channels.
  - a. Write a value of 0x0002h to Control Register 40241 to Write-Enable the module.
  - b. Retrieve Trim Zero register value for specific range from Table 2.0 below.
  - c. Write value of 0x00h to Range Trim Zero register, (ie. 40114 for +/-10V).
  - d. Perform steps #4a through #4c to trim zero on each range.

##### Trim Span:

1. Set the DC calibrator voltage output to +10.000Vdc.
2. Use the DGH Utility Software or a Modbus Master program to perform steps #3 & #5.
3. Set all channels to the same range. Start with +/-0.025Vdc range, work upward as per values in Table 3.0.
4. Trim Span on each channel.
  - a. Write a value of 0x0002h to Control Register 40241 to Write-Enable the module.
  - b. Retrieve Trim Span register value for specific range from Table 2.0 below.
  - c. Write value of 0xfffe to Trim Span register, (ie. 40146 for +/-10V).
  - d. Perform steps #4a through #4c to trim span on each range.

##### Trim CJC's:

1. Set the input signal to -----.
2. Set all module channels to the J-Thermocouple range.
3. Use the DGH Utility Software or a Modbus Master program to perform steps #4 & #5.
4. Trim Zero on each input channel
  - a. Write a value of 0x0002h to Control Register 40241 to Write-Enable the module.
  - b. Write a value of 0x0000h to register 40114.
5. Apply input signal to each channel from Table x.xx.
  - a. Wait 1 minute.
  - b. Write a value of 0x0002h to Control Register 40241 to Write-Enable the module.
  - c. Write a value of 0xfffe

### Trim Thermocouples:

1. Set the input signal to -----.
2. Set all module channels to the J-Thermocouple range.
3. Use the DGH Utility Software or a Modbus Master program to perform steps #4 & #5.
4. Trim Zero on each input channel
  - a. Write a value of 0x0002h to Control Register 40241 to Write-Enable the module.
  - b. Write a value of 0x0000h to register 40114.
5. Apply input signal to each channel from Table x.xx.
  - a. Wait 1 minute.
  - b. Write a value of 0x0002h to Control Register 40241 to Write-Enable the module.
  - c. Write a value of 0xfffe

#### 4.4.5 Seven Channel Voltage, Thermocouple and Current Input Calibration Tables:

<b>Seven Channel Range Register Values</b>			
<b>Channel</b>	<b>Range Control</b>	<b>Range Values</b>	
Channel 1	40097	00	Disabled
Channel 2	40098	01	+/-10V
Channel 3	40099	02	+/-5V
Channel 4	40100	03	+/-1V
Channel 5	40101	04	+/-0.1V
Channel 6	40102	05	+/-0.05V
Channel 7	40103	06	+/-0.025V
		21	J-Type TC
		22	K-Type TC
		23	T-Type TC
		24	E-Type TC
		25	R-Type TC
		26	S-Type TC
		27	B-Type TC
		28	C-Type TC

**Table 1.0** Register Setup Values.

<b>Trim Zero Registers and Calibration Values</b>		
<b>Range</b>	<b>Register</b>	<b>Value</b>
+/-10Vdc	40114	0000
+/-5Vdc	40115	0000
+/-1Vdc	40116	0000
+/-0.1Vdc	40117	0000
+/-0.05Vdc	40118	0000
+/-0.025Vdc	40119	0000

**Table 2.0** Trim Zero Registers and Values.

<b>Trim Span Registers and Calibration Values</b>		
<b>Range</b>	<b>Register</b>	<b>Value</b>
+/-0.025Vdc	40151	FFFE
+/-0.05Vdc	40150	FFFE
+/-0.1Vdc	40149	FFFE
+/-1Vdc	40148	FFFE
+/-5Vdc	40147	FFFE
+/-10Vdc	40146	FFFE

**Table 3.0** Trim Span Registers and Values.

<b>CJC Calibration Registers and Values</b>			
<b>Channels</b>	<b>Register</b>	<b>Increase Value</b>	<b>Decrease Value</b>
0..3	40129	0001	0000
4..6	40130	0001	0000

**Table 4.0** Trim CJC Registers and Values.

## 4.4.6 D6400 Current Channel Enable:

### Overview

The following information details how to open the D6400 module and enable or disable current channels.

### Default from the Factory

No current enabling jumpers are installed at the factory. All channels are initialized as voltage inputs.

### Open the Module

Remove the top cover of the D6400 module by unscrewing the four screws on the top cover. With the cover removed, locate J100, a storage strip that contains up to seven unused jumpers. Then locate the CH1 through CH7 jumper strips that enable current channels.

### Move the Jumpers

To enable any channel as a current input channel, simply move a jumper from J100 to the specific channel jumper strip. To disable a current input channel, simply move the jumper from the channel jumper strip back to J100. See the image below for the location of the pin strips versus channels.

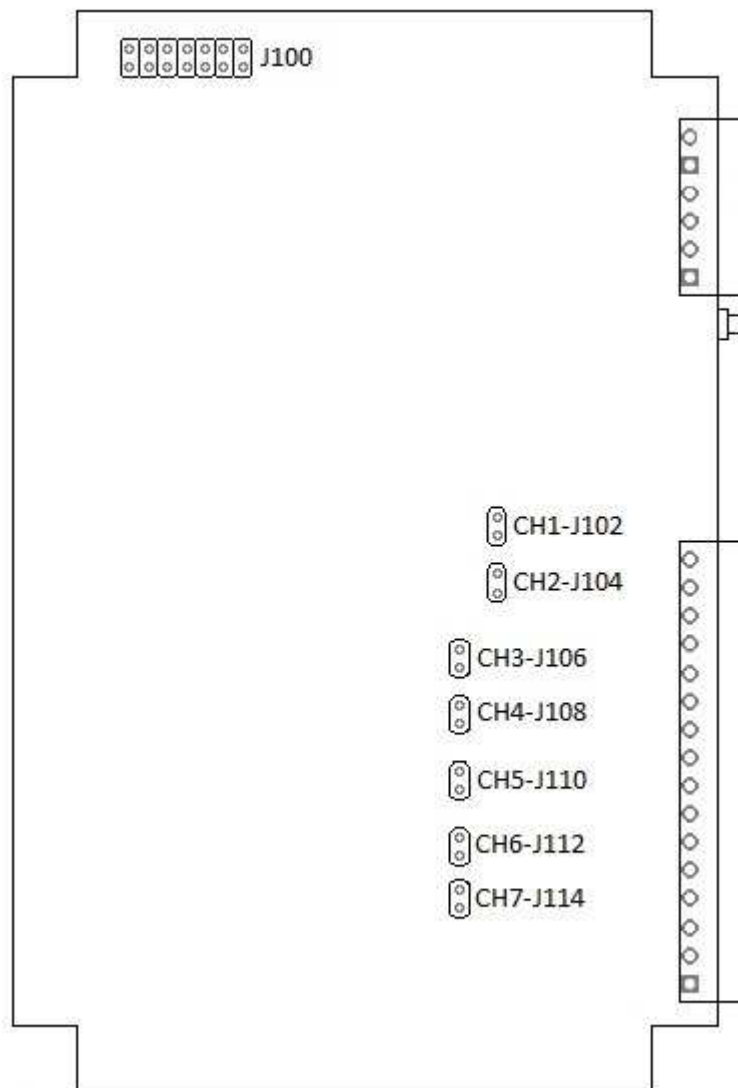





## 4.5 D6500 Two Channel Analog Output Module

### Overview

The D6500 series analog output module contains two 12-bit analog outputs for controlling process control devices. Each analog output signal can be configured as either a voltage or current output. Two voltage ranges and two current ranges can be selected for maximum flexibility to control many different process control devices.

### Analog Outputs

The D6500 series analog outputs can be configured as either voltage outputs or current outputs.

### Features and Register Assignments

The D6500 series modules contain many user-selectable features. The user can select all features such as baud rate, parity type, power-on “safe” analog output value and communications watchdog timer interval. The complete list of features is illustrated in the [“Two Channel Analog Output Register Assignments”](#) register map below. The register map format is used for consistency with the Modbus RTU protocol. The register map contains the register numbers in decimal format, register description, acceptable data values, and list of what each value means. These registers can be written to using most any Modbus master program or using the DGH D6000 series utility software.

**Note:** All Modbus Register values in the tables below are represented as “decimal” numbers.

### Factory Initial Values

The D6500 series analog output modules are initialized at the factory with a set of “Initial Values”. A complete list of factory [“Initial Values”](#) can be found in the table below. For reference purposes, the Modbus Slave address is preset to hex 0x01, the baud rate is 9600, Parity type is None and the Stop Bits is “1”.

### Communications Watchdog Timer

The D6500 series digital output module contains a user-programmable communications watchdog timer. The communications watchdog timer can be used to force the analog output signals to a known “safe” condition in the event that communications are lost to the module. The known “safe” condition can be user-programmed into the module Initial Value register.

### Connector Pin Designations

The D6500 series module uses two 3.81mm removable plugs for connecting signals to the module. One six-pin connector is for the power supply and the host RS-485 data line connections. A second eight-pin connector is used to connect analog output signals to control devices. The [pin designations](#) for each connector are printed on the module label and are listed in a table below.

## 4.5.1 Two Channel Analog Output Pin Assignments and Specifications

### Connections

#### Power & Serial Communications

<u>Pin Number</u>	<u>Pin</u>	<u>Designator</u>
1	GND	- Power Supply
2	+VS	+ Power Supply
3	Data-	RS-485 Data-
4	Data+	RS-485 Data+
5	Default*	Default*
6	GND	

#### Analog Output Pin Assignments

<u>Pin Number</u>	<u>Pin</u>	<u>Designator</u>
1	CH1 +I	#1-+Current Out
2	CH1 -I	#1- -Current Out
3	CH1 +V	#1- +Voltage Out
4	CH1 -V	#1- -Voltage Out
5	CH2 +I	#2- +Current Out
6	CH2 -I	#2- -Current Out
7	CH2 +V	#2- +Voltage Out
8	CH2 -V	#2- -Voltage Out

#### Notes:

1. Each channel can be used as either a voltage output or a current output. But not both at the same time.
2. When using a channel as a current output there must be no connections on +/-V Output pins.

### Specifications

Analog Outputs	2 Channels
User Selectable Input Ranges	
Voltage Ranges	0-10V, +/-10V,
Current Ranges	4-20mA, 0-20mA
Protocol	
Serial	Modbus RTU
Power Supply	
Voltage	+10-30Vdc
Power	2.1W
Connectors	
Spacing	3.81mm
Max Wire Size	14-24 AWG
Max Current	8 Amperes
Serial LED Displays	
Transmit (Top)	Serial TxData
Receive (Bottom)	Serial RxData

#### 4.5.2 Two Channel Analog Output Register Assignments

Register	Description	Functions	Value	Description
40001	Slave Address	R/WP	1-DF	<b>Factory set to 0x0001.</b>
40002	UART Setup	R/WP	5-9	<p><u>Bits 0-4 Baud Rate</u>                      5=9600                      6=19.2K                      7=38.4K                      8=57.6K                      9=115.2K</p> <p><u>Bits 5-6 Parity</u>                      0=No Parity, 8-N-2                      1=Odd                      2=Even                      3=No Parity, 8-N-1</p> <p><b>Factory set to 0x0035 = 9600, 8, N, 1.</b></p>
40003	Modbus Delays	R/WP	0-303F	<p><u>Bits 0-7</u>                      The Response Delay in milliseconds. This is required when the RS-485 adapter cannot tri-state immediately after the last character is transmitted from the host. Maximum value is 63mS. Factory default value is 3.</p> <p><u>Bits 8-15</u>                      The End of Query Delay in milliseconds (48mS max). This is an additional time that the module will wait prior to marking the end of the message. Slower host computers may not be able transmit a continuous message stream, thereby creating gaps between characters exceeding the normal 3.5 character times limit. Factory default value is 0.</p> <p><b>Factory set to 0x0003.</b></p>
40033	Software Version	R		<b>Factory set from data value in source code.</b>
40049	Analog Out CH1	R/W	0-FFFF	0= -FS, FFFF= +FS, Set analog output, DAC value after slewing.
40050	Analog Out Ch2	R/W	0-FFFF	See Register 49.
40065	Slope CH1	R/W	0-12	<p>On the fly slope. Reset default slope from EEPROM.</p> <p>0 – Immediate                      1 – 0.156% Span/s                      2 – 0.310                      3 – 0.625                      4 – 1.25                      5 – 2.50                      6 – 5                      7 – 10                      8 – 20                      9 – 40                      A – 80                      B – 160                      C – 320                      D – 640                      E – 1280                      F – 2560                      10 – 5120                      11 – 10240                      12 – 20480</p>

				V/S=% Span/s (Span)/100 i.e. for slope= 10, 5120(10)/100=512V/S <b>Factory set to 0x0000.</b>
40066	Slope CH2	R/W	0-1FFFF	On the fly slope. <b>Factory set to 0x0000.</b>
40097	ADC Read CH1	R	0-FFFF	Readback CH1, 8 bit resolution.
40098	ADC Read CH2	R		Readback CH2, 8 bit resolution.
40113	Present Output CH1	R	0-FFFF	Normalized present DAC value. Present Output may differ from Setpoint, if output has not reached to its final value.
40114	Present Output CH2	R	0-FFFF	Normalized present DAC value. Present Output may differ from Setpoint, if output has not reached to its final value.
40144	Watchdog Time-out Interval	R/WP	0-FFFF	The interval of time in seconds that must lapse after the last communication to the module or since power was applied, before the Watchdog is triggered and the outputs are set to the Initial Value. Effective immediately. The purpose of the Watchdog Timer is to force the analog outputs to a known safe value in the event of a host or communications link failure. The Watchdog Timer may be disabled, by setting the value to FFFF Hex. Accuracy is 10%. <b>Factory set to 0xFFFF.</b>
40145	Setup CH1	R/WP		Holds Channel 1 range and slope setup. On the fly slope changed immediately. Setup change is immediate. <u>Bits 0-2</u> 0 – 0-10V 1 – +/-10V 2 – 4-20mA 3 – 0-20mA  <u>Bits 3-7</u> 0 – Immediate 1 – 0.156% Span/s 2 – 0.31 3 – 0.625 4 – 1.25 5 – 2.50 6 – 5 7 – 10 8 – 20 9 – 40 A – 80 B – 160 C – 320 D – 640 E – 1280 F – 2560 10 – 5120 11 – 10240 12 – 20480 V/S=% Span/s (Span)/100 i.e. for slope= 10, 5120(10)/100=512V/S <b>Factory set to 0x0000.</b>
40146	Initial Value CH1	R/WP	0-FFFF	Power-Up or Reset analog output value. <b>Factory set to 0x0000.</b>
40147	Setup CH2	R/WP		Holds Channel 2 range and slope setup. <b>Factory set to 0x0000.</b>

40148	Initial Value CH2	R/WP	0-FFFF	Power-Up or Reset analog output value. <b>Factory set to 0x0000.</b>
40177	Increase Min Output Calibration	WP	0-1	Increases output of selected channel, by 1 LSB. Output must be previously set to minimum value in table xx. Repeat as needed get the desired output. The effect is immediate. <b>Write 0 for Channel 1</b> <b>Write 1 for Channel 2</b>
40178	Decrease Min Output Calibration	WP	0-1	Decreases output of selected channel, by 1 LSB. Output must be previously set to minimum value in table xx. Repeat as needed to get desired output. The effect is immediate. <b>Write 0 for Channel 1</b> <b>Write 1 for Channel 2</b>
40179	Increase Max Output Calibration	WP	0-1	Increases output of selected channel, by 1 LSB. Output must be previously set to maximum value in table xx. Repeat as needed get the desired output. The effect is immediate. <b>Write 0 for Channel 1</b> <b>Write 1 for Channel 2</b>
40180	Decrease Max Output Calibration	WP	0-1	Decreases output of selected channel, by 1 LSB. Output must be previously set to maximum value in table xx. Repeat as needed to get desired output. The effect is immediate. <b>Write 0 for Channel 1</b> <b>Write 1 for Channel 2</b>
40181	Trim ADC	WP	0-1	Forces output of selected channel (data value) to minimum and maximum values momentarily, and calibrates readback ADC to coincide. Output is then restored to original value when calibration is completed. The effect is immediate.
<b>40241</b>	<b>Control</b>	<b>W</b>		<b>0</b> – Normal operation (NOP) <b>1</b> – Remote Reset (write protected) <b>2</b> – Write Enable <b>5</b> – Initialize Host communications setup

**Functions:**

R Read Only  
R/W Read/Write  
WP Write-Protected

**Notes:**

1. Values written to Registers 40049 and 40050 **must not** be proceeded by a Write-Protect command.

#### 4.5.3 Two Channel Analog Output Initial Factory Values

<b>Module Parameter</b>	<b>Value</b>
Slave Address	1
Baud Rate	9600
Parity Type	None
Modbus Response Delay	3mS
Modbus Query Delay	0mS
Conversion Rate	60Hz
Channel 0 on the fly slope	Immediate
Channel 1 on the fly slope	Immediate
Watchdog Timer Low Word	0xffff, = Disabled
Channel 0 Range	0-10Vdc
Channel 0 Slope	Immediate
Channel 0 Initial Value	0Vdc
Channel 1 Range	0-10Vdc
Channel 1 Slope	Immediate
Channel 1 Initial Value	0Vdc

## 4.5.4 Analog Voltage Output Calibration Procedure

### Required Equipment

1. Computer running the DGH Utility Software or another Modbus Master program.
2. A NIST traceable Digital multimeter (DMM) with +/-10Vdc range.

### Setup Steps – Perform Calibration Steps in Order Listed:

1. Allow unit to warm up for 15 minutes.
2. Connect positive (+) lead of the DMM to the Ch1 +Vout terminal.
3. Connect negative (-) lead of the DMM to the Ch1 IsoGnd terminal.
4. Install the DGH Utility Software or another Modbus Master Program to communicate with, and calibrate with the module via serial port or a TCP/IP connection.
5. Remove all connections to the +Iout and –Iout terminals on Ch1 and Ch2.

### Trim Negative Full Scale:

1. Using the DGH Utility Software configure both Ch1 and Ch2 analog output ranges to the +/-10Vdc range. See Table 1.0 below for register and data values.
2. Use the DGH Utility Software set Ch1 and Ch2 analog outputs to their –Full Scale value. See Table 2.0 below for register and data values.
3. Trim Negative Full Scale.
  - a. Write a value of 0x0002h to Control Register 40241 to Write-Enable the module.
  - b. Trim the Negative Full Scale output using the register and data value in Table 3.0 below. Write value the channel value to the proper register to increase or decrease the analog output signal to match the –Full Scale output value.
4. Move the DMM leads to the Ch2 +Vout and IsoGnd terminals.
5. Repeat steps 3a and 3b to trim the negative full-scale output of Ch2.

### Trim Positive Full Scale:

1. Move the DMM leads to the Ch1 +Vout and –Vout terminals.
2. Use the DGH Utility Software set Ch1 and Ch2 analog outputs to their +Full Scale value. See Table 2.0 below for register and data values.
3. Trim Positive Full Scale.
  - a. Write a value of 0x0002h to Control Register 40241 to Write-Enable the module.
  - b. Trim the Positive Full Scale output using the register and data value in Table 4.0 below. Write value the channel value to the proper register to increase or decrease the analog output signal to match the +Full Scale output value.
4. Move the DMM leads to the Ch2 +Vout and IsoGnd terminals.
5. Repeat steps 3a and 3b to trim the positive full-scale output of Ch2.
6. Using the DGH Utility Software set the Ch1 and Ch2 analog output ranges to +10Vdc range. Repeat steps above calibrate the 0-10Vdc range.

## 4.5.5 Analog Current Output Calibration Procedure

### Required Equipment

1. Computer running the DGH Utility Software or another Modbus Master program.
2. A NIST traceable Digital multimeter (DMM) with 0-20mA range.

### Setup Steps – Perform Calibration Steps in Order Listed:

1. Allow unit to warm up for 15 minutes.
2. Connect positive (+) lead of the DMM to the Ch1 +Iout terminal.
3. Connect negative (-) lead of the DMM to the Ch1 -Iout terminal.
4. Install the DGH Utility Software or another Modbus Master Program to communicate with, and calibrate with the module via serial port or a TCP/IP connection.
5. Remove all connections to the +Vout and –Vout terminals on Ch1 and Ch2.

### Trim Negative Full Scale:

1. Using the DGH Utility Software configure both Ch1 and Ch2 analog output ranges to the 0-20mA range. See Table 1.0 below for register and data values.
2. Use the DGH Utility Software set Ch1 and Ch2 analog outputs to their –Full Scale value. See Table 2.0 below for register and data values.
3. Trim Negative Full Scale.
  - a. Write a value of 0x0002h to Control Register 40241 to Write-Enable the module.
  - b. Trim the Negative Full Scale output using the register and data value in Table 3.0 below. Write value the channel value to the proper register to increase or decrease the analog output signal to match the –Full Scale output value.
4. Move the DMM leads to the Ch2 +Iout and –Iout terminals.
5. Repeat steps 3a and 3b to trim the negative full-scale output of Ch2.

### Trim Positive Full Scale:

1. Move the DMM leads to the Ch1 +Iout and –Iout terminals.
2. Use the DGH Utility Software set Ch1 and Ch2 analog outputs to their +Full Scale value. See Table 2.0 below for register and data values.
3. Trim Positive Full Scale.
  - a. Write a value of 0x0002h to Control Register 40241 to Write-Enable the module.
  - b. Trim the Positive Full Scale output using the register and data value in Table 4.0 below. Write value the channel value to the proper register to increase or decrease the analog output signal to match the +Full Scale output value.
4. Move the DMM leads to the Ch2 +Iout and –Iout terminals.
5. Repeat steps 3a and 3b to trim the positive full-scale output of Ch2.
6. Using the DGH Utility Software set the Ch1 and Ch2 analog output ranges to 4-20mA range. Repeat steps above to calibrate the 4-20mA range.



#### 4.5.6 Analog Output Calibration Register Tables and Values

<u>Channel Range Registers and Values</u>		
<u>Channel</u>	<u>Range Control</u>	<u>Range Values</u>
Channel 1	40145	0 = 0-10Vdc 1 = +/-10Vdc 2 = 4-20mA 3 = 0-20mA
Channel 2	40146	

**Table 1.0** Analog Output Range Registers and Values.

<u>Analog Output Registers</u>			
<u>Channel</u>	<u>Register</u>	<u>Force -FS Output</u>	<u>Force +FS Output</u>
Channel 1	40049	0000	FFFF
Channel 2	40050	0000	FFFF

**Table 2.0** Analog Output Register and Calibration Values.

<u>Trim Negative Full Scale Calibration Registers and Values</u>			
<u>Register</u>	<u>-Full Scale Output Adjust</u>	<u>CH1</u>	<u>CH2</u>
40177	Increase Signal	0000	0001
40178	Decrease Signal	0000	0001

**Table 3.0** Trim Negative Full Scale Calibration Registers and Values.

<u>Trim Positive Full Scale Calibration Registers and Values</u>			
<u>Register</u>	<u>+Full Scale Signal Adjust</u>	<u>CH1</u>	<u>CH2</u>
40179	Increase Signal	0000	0001
40180	Decrease Signal	0000	0001

**Table 4.0** Trim Positive Full Scale Calibration Registers and Values.

## 4.6 D6710 - Fifteen Bit Digital Input Module

### Overview

The D6710 series module contains fifteen digital inputs to monitor process signals such as logic-level status, relay contacts, switch closures, and dry-contacts.

### Digital Inputs

The D6710 digital input bits accept signals between +/-30Vdc without damage and contain internal 10K pull-up resistors for direct connection to dry-contacts.

The digital input logic level switching levels are less than 1.0Vdc for logic "0" and greater than +3.5Vdc for a logic "1".

### Features and Register Assignments

The D6710 series digital input modules contain many user-selectable features. The user can select all features such as device address, baud rate and parity type. The complete list of features is illustrated in the "[Fifteen Bit Digital I/O Register Assignments](#)" map below. The register map format is used for consistency with the Modbus RTU protocol. The register map contains the register numbers in decimal format, register description, acceptable data values, and list of what each value means. These registers can be written to using most any Modbus master program or using the DGH D6000 series utility software.

**Note:** All Modbus Register values in the tables below are represented as "decimal" numbers.

### Connector Pin Designations

The D6710 series module uses two 3.81mm removable plugs for connecting signals to the module. One six-pin connector is for the power supply and the host RS-485 data line connections. A second sixteen-pin connector is used to connect digital signals to the module. The [pin designations](#) for each connector are printed on the module label and are listed in a table below.

## 4.6.2 Fifteen Bit Digital Input Specifications

### Connections

#### Power and Serial Communications

Pin Number	Pin	Designator
1	GND	- Power Supply
2	+VS	+ Power Supply
3	DATA-	RS-485 Data-
4	DATA+	RS-485 Data+
5	Default*	Default*
6	GND	- Power Supply

### Typical Input

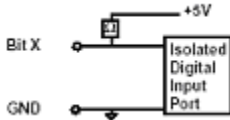

### Digital Input Pin Assignments

Bit Number	Pin Designator
1	B01
2	B02
3	B03
4	B04
5	B05
6	B06
7	B07
8	B08
9	B09
10	B10
11	B11
12	B12
13	B13
14	B14
15	B15
16	ISO. GND

### Specifications

Digital Inputs	15
Input Bit	
Internal Pull-up	10K to +5Vdc
Max Voltage	+/-30Vdc
Logic '0'	<1.0Vdc
Logic '1'	>3.5Vdc
Isolation	
GND to IGND	500Vrms
Protocol	
Serial	Modbus RTU
Power Supply	
Voltage	+10-30Vdc
Power	0.75W

Connectors	
Spacing	3.81 mm
Max Wire Size	14-24 AWG
Max Current	8 Amperes

LED Designators	
01-15	Bit LO = On
F	Always Off
T	Serial TxD
R	Serial RxD

### LED Display

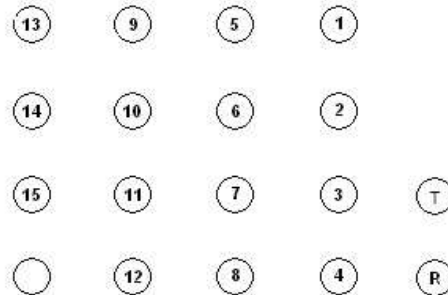

Digital Input/Output LEDs

#### 4.6.3 Fifteen Bit Digital Input Initial Factory Values

<b>Module Parameter</b>	<b>Value</b>
Slave Address	1
Baud Rate	9600
Parity Type	None
Modbus Response Delay	3mS
Modbus Query Delay	0mS

#### 4.6.4 Fifteen Bit Digital Input Register Assignments

Register	Description	Functions	Value	Description
40001	Slave Address	R/WP	1-DF	<b>Factory set to 0x0001.</b>
40002	UART Setup	R/WP		<u>Bits 0-4 Baud Rate</u> 5=9600 6=19.2K 7= 38.4K 8=57.6K 9=115.2K  <u>Bits 5-6 Parity</u> 0=No Parity, 8-N-2 1=Odd 2=Even 3=No Parity, 8-N-1 <b>Factory set to 0x0035 = 9600, 8, N, 1.</b>
40003	Modbus Delays	R/WP	0-303F	<u>Bits 0-7</u> The Response Delay in milliseconds. This is required when the RS-485 adapter cannot tri-state immediately after the last character is transmitted from the host. Maximum value is 63mS. Factory default value is 3.  <u>Bits 8-15</u> The End of Query Delay in milliseconds (48mS max). This is an additional time that the module will wait prior to marking the end of the message. Slower host computers may not be able transmit a continuous message stream, thereby creating gaps between characters exceeding the normal 3.5 character times limit. Factory default value is 0. <b>See Note 2.</b> <b>Factory set to 0x0003.</b>
40033	Software Version	R		<b>Factory set, Code Version.</b>
<b>40241</b>	<b>Control Register</b>	<b>W</b>		<b>0</b> – Normal operation (NOP) <b>1</b> – Remote Reset (write protected) <b>2</b> – Write Enable <b>3</b> – Synchronous Data sample <b>5</b> – Init Host Com Setup

**Functions:**

R     Read Only  
 R/W   Read/Write  
 WP    Write-Protected

<b>Discrete Coil (DI) Mapping Table</b>			
Address (hex)	Channel #	Coil #	Using Function Codes 01 and 02
0	0	1	“
1	1	2	“
2	2	3	“
:			
15	15	15	“
100	0	1	Sync Input Data
101	1	2	“
102	2	3	“
:			
10E	14	15	“

## 4.7 D6720 - Fifteen Bit Digital Output Module

### Overview

The D6720 series digital output module contains fifteen digital outputs for controlling process control devices such as relays, lamps, annunciators and other ON/OFF devices.

### Digital Outputs

The D6720 series open-collector digital outputs can be pulled up to +30Vdc max and each bit can sink up to 100mA. The open-collector output provides maximum flexibility to control many different process control devices.

### Features and Register Assignments

The D6720 series digital output modules contain many user-selectable features. The user can select all features such as baud rate, parity type, power-on bit state and communications watchdog timer interval. The complete list of features is illustrated in the [“Fifteen Bit Digital I/O Register Assignments”](#) register map below. The register map format is used for consistency with the Modbus RTU protocol. The register map contains the register numbers in decimal format, register description, acceptable data values, and list of what each value means. These registers can be written to using most any Modbus master program or using the DGH D6000 series utility software.

**Note:** All Modbus Register values in the tables below are represented as “decimal” numbers.

### Factory Initial Values

The D6720 series digital output modules are initialized at the factory with a set of “Initial Values”. A complete list of factory “Initial Values” can be found in the table below. For reference purposes, the Modbus Slave address is preset to hex 0x01, the baud rate is 9600, Parity type is None and the Stop Bits is “1”.

### Communications Watchdog Timer

The D6720 series digital output module contains a user-programmable communications watchdog timer. The communications watchdog timer can be used to force the digital outputs to a known “safe” condition in the event of a communications lost to the module. The known “safe” condition can be user-programmed into the module Initial Value register.

### Connector Pin Designations

The D6720 series module uses two 3.81mm removable plugs for connecting signals to the module. One six-pin connector is for the power supply and the host RS-485 data line connections. A second sixteen-pin connector is used to connect digital signals to the module. The [pin designations](#) for each connector are printed on the module label and are listed in a table below.

## 4.7.2 Fifteen Bit Digital Output Specifications

### Connections

#### Power and Serial Communications

Pin Number	Pin	Designator
1	GND	- Power Supply
2	+VS	+ Power Supply
3	DATA-	RS-485 Data-
4	DATA+	RS-485 Data+
5	Default*	Default*
6	GND	- Power Supply

### Typical Output Circuit

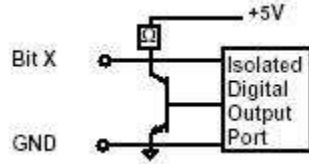

### Digital Output Pin Assignments

Bit Number	Pin Designator
1	B01
2	B02
3	B03
4	B04
5	B05
6	B06
7	B07
8	B08
9	B09
10	B10
11	B11
12	B12
13	B13
14	B14
15	B15
16	ISO. GND

### Specifications

Digital Outputs	15
Output Bit	
Open-Collector	30Vdc, 100mA
Vsat	0.3V @ 100mA
Short Circuit	500mA max
Type	Sinking

Isolation	
GND to IGND	500Vrms

Watchdog Timer	
Range	0 to 655.35 Sec
Resolution	0.35 Sec

Protocol	
Serial	Modbus RTU

Power Supply	
Voltage	+10-30Vdc
Power	1.0W

Connectors	
Spacing	3.81mm
Max Wire Size	14-24 AWG
Max Current	8 Amperes

LED Designators	
01-15	Bit LO = On
F	Always Off
T	Serial TxD
R	Serial RxD

### LED Display

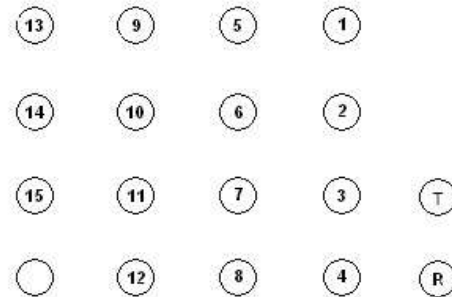

Digital Input/Output LEDs

#### 4.7.3 Fifteen Bit Digital Output Initial Factory Values

<b>Module Parameter</b>	<b>Value</b>
Slave Address	1
Baud Rate	9600
Parity Type	None
Modbus Response Delay	3mS
Modbus Query Delay	0mS
Digital Output Initial Value	0x0000 = All Outputs Off
Watchdog Timer Low Word	0xffff, = Disabled



#### 4.7.4 Fifteen Bit Digital Output Register Assignments

Register	Description	Functions	Value	Description
40001	Slave Address	R/WP	1-DF	<b>Factory set to 0x0001.</b>
40002	UART Setup	R/WP		<p><u>Bits 0-4 Baud Rate</u>            5=9600            6=19.2K            7= 38.4K            8=57.6K            9=115.2K</p> <p><u>Bits 5-6 Parity</u>            0=No Parity, 8-N-2            1=Odd            2=Even            3=No Parity, 8-N-1</p> <p><b>Factory set to 0x0035 = 9600, 8, N, 1.</b></p>
40003	Modbus Delays	R/WP	0-303F	<p><u>Bits 0-7</u>            The Response Delay in milliseconds. This is required when the RS-485 adapter cannot tri-state immediately after the last character is transmitted from the host. Maximum value is 63mS. Factory default value is 3.</p> <p><u>Bits 8-15</u>            The End of Query Delay in milliseconds (48mS max). This is an additional time that the module will wait prior to marking the end of the message. Slower host computers may not be able transmit a continuous message stream, thereby creating gaps between characters exceeding the normal 3.5 character times limit. Factory default value is 0.</p> <p><b>See Note 2.</b>  <b>Factory set to 0x0003.</b></p>
40033	Software Version	R		<b>Factory set, Code Version.</b>
40096	Watchdog Timer Interval	R/WP	0.FFFF	<p>The interval of time in seconds that must elapse after the last communication to the module or since the power was applied, before the outputs are set to the Initial Value. The purpose of the Watchdog Timer is to force the digital outputs to a known safe value in the event of a host or communications link failure. The Watchdog Timer may be disabled by setting the value to 0xFFFF hex.</p> <p><b>Factory set to 0xFFFF.</b></p>
40097	Initial Value	R/WP	0.FFFF	<p>Starting condition of Coils 1-15. Bit #0 is Ch0. Initial Value bits set to Logic 1 will be initialized to the "On" state. Bits set to Logic 0 will be initialized to the "Off" state.</p> <p><b>Factory Set to 0x0000.</b></p>
40241	<b>Control Register</b>	<b>W</b>		<p><b>0</b> – Normal operation (NOP)  <b>1</b> – Remote Reset (write protected)  <b>2</b> – Write Enable  <b>3</b> – Synchronous Data sample  <b>5</b> – Init Host Com Setup</p>

<b>Discrete Coil (DI) Mapping Table</b>			
<b>Address (hex)</b>	<b>Channel #</b>	<b>Coil #</b>	<b>Using Function Codes 01 and 02</b>
0	0	1	“
1	1	2	“
2	2	3	“
:			
E	E	E	“
100	0	1	Sync Input Data
101	1	2	“
102	2	3	“
:			
10E	14	15	“

**Functions:**

R     Read Only  
R/W    Read/Write  
WP     Write-Protected

## 5.0 Modbus Protocol

The D6000 series modules utilize the Modbus RTU protocol for communications. The Modbus RTU protocol is widely supported protocol supported by almost all commercial data acquisition programs and programmable controllers in the marketplace. This allows for easy connection of a D6000 series module to an existing system or new application.

The D6000 series modules utilize up to eight different functions from within the Modbus RTU protocol. The number of functions utilized by a module depends on the model type and the features it contains.

The Modbus functions allow users to control every function within a module. The functions and their descriptions are listed below. Each function is also outlined in further detail below.

<b>Function</b>	<b>Description</b>
<b>01</b>	Return coil status of discrete output points
<b>02</b>	Read ON/OFF status of discrete inputs in the slave device
<b>03</b>	Read content of holding registers (4X references) in the slave device
<b>04</b>	Read content of input registers (3X references) in the slave device
<b>05</b>	Force state of a single coil (digital output) to either ON or OFF
<b>06</b>	Preset the state of a single register to a specific value
<b>0F</b>	Force the state of a sequence of coils (digital outputs) to a specific state
<b>10</b>	Preset a sequence of registers (4X references) to specific values

### 5.1.1 Function 01 – Read Coil Status

This function returns the coil status of discrete digital output points. A typical function 01 command and response is detailed below:

#### Command Usage:

Address	One Byte Slave Address
Function	One Byte Function Number
Addr HI	Starting Address HI Byte
Addr LO	Starting Address LO Byte
Data HI	Typically ZERO
Data LO	Number of bits, limited to 1..64

#### Response Message:

Address	One Byte Slave Address	
Function	One Byte Function Number	
Register Number	Number of data bytes	Typically returns four bytes
Data HI	Data Coils (27-20)	
Data LO	Data Coils (35-28)	
Data HI	Data Coils (43-36)	
Data LO	Data Coils (51-44)	
Error Check	Two Byte CRC	

### 5.1.2 Function 02 – Read Input Status

Read the ON/OFF status of discrete digital input bits in the slave device. A typical function 02 command and response is detailed below:

#### Command Usage:

Address	One Byte Slave Address
Function	One Byte Function Number
Addr HI	Starting Address HI Byte
Addr LO	Starting Address LO Byte
Data HI	Typically ZERO
Data LO	Number of bits, limited to 1..64

#### Response Message:

Address	One Byte Slave Address	
Function	One Byte Function Number	
Register Number	Number of data bytes	Typically returns four bytes
Data HI	Data Coils (27-20)	
Data LO	Data Coils (35-28)	
Data HI	Data Coils (43-36)	
Data LO	Data Coils (51-44)	
Error Check	Two Byte CRC	

### 5.1.3 Function 03 – Read Holding Registers

This function returns the contents of hold registers (4X references) in the slave device. A typical function 03 command and response is detailed below:

#### Command Usage:

Address	One Byte Slave Address
Function	One Byte Function Number
Addr HI	Starting Register Address HI Byte
Addr LO	Starting Register Address LO Byte
Data HI	Typically ZERO
Data LO	Number of registers

#### Response Message:

Address	One Byte Slave Address	
Function	One Byte Function Number	
Register Number	Number of data bytes	Typically returns two bytes
Data HI	HI Byte (8-bits)	
Data LO	LO Byte (8-bits)	
Error Check	Two Byte CRC	

### 5.1.4 Function 04 – Read Input Registers

This function returns the contents of hold registers (3X references) in the slave device. A typical function 04 command and response is detailed below:

#### Command Usage:

Address	One Byte Slave Address
Function	One Byte Function Number
Addr HI	Starting Register Address HI Byte
Addr LO	Starting Register Address LO Byte
Data HI	Typically ZERO
Data LO	Number of registers

#### Response Message:

Address	One Byte Slave Address	
Function	One Byte Function Number	
Register Number	Number of data bytes	Typically returns two bytes
Data HI	HI Byte (8-bits)	
Data LO	LO Byte (8-bits)	
Error Check	Two Byte CRC	

### 5.1.5 Function 05 – Force Single Coil

This function forces the state of a single coil (digital output) to either the ON or OFF state. A typical function 05 command and response is listed below:

#### Command Usage:

Address	One Byte Slave Address
Function	One Byte Function Number

Addr HI	Coil Address HI Byte
Addr LO	Coil Address LO Byte

Data HI	Force Data HI
Data LO	Force Data LO

Data Values: The proper values are either 0xFF00 to enable (Turn ON) a bit or 0x0000 to disable (turn off) a bit.

#### Response Message:

Address	One Byte Slave Address
Function	One Byte Function Number

Addr HI	Coil Address HI Byte	Same value as in command above.
Addr LO	Coil Address LO Byte	Same value as in command above.

Data HI	Force Data HI	Same value as in command above.
Data LO	Force Data LO	Same value as in command above.

Error Check	Two Byte CRC
-------------	--------------



### 5.1.6 Function 06 – Preset Single Register

This function presets the state of a single register to a specific value. A typical function 06 command and response is listed below:

#### Command Usage:

Address	One Byte Slave Address
Function	One Byte Function Number
Addr HI	Starting Register Address HI Byte
Addr LO	Starting Register Address LO Byte
Data HI	Force Data HI
Data LO	Force Data LO

#### Response Message:

Address	One Byte Slave Address	
Function	One Byte Function Number	
Addr HI	Register Address HI Byte	Same value as in command above.
Addr LO	Register Address LO Byte	Same value as in command above.
Data HI	Preset Data value HI	Same value as in command above.
Data LO	Preset Data value LO	Same value as in command above.
Error Check	Two Byte CRC	

### 5.1.7 Function 0F – Force Multiple Coils

This function is used to force the state of multiple coils (digital outputs) in a digital output module. A typical function 0F command and response is listed below:

#### Command Usage:

Address	One Byte Slave Address
Function	One Byte Function Number
Starting Addr HI	Starting Address HI Byte
Starting Addr LO	Starting Address LO Byte
Qty Coils HI	Number of Coils to Write HI
Qty Coils LO	Number of Coils to Write LO
Byte Count	Number of Data Bytes Transmitted
Force Data HI	Force Data HI
Force Data LO	Force Data LO

#### Response Message:

Address	One Byte Slave Address	
Function	One Byte Function Number	
Starting Addr HI	Starting Address HI Byte	Same value as in command above.
Starting Addr LO	Starting Address LO Byte	Same value as in command above.
Qty Coils HI	Qty Coils HI	Same value as in command above.
Qty Coils LO	Qty Coils LO	Same value as in command above.
Error Check	Two Byte CRC	

### 5.1.8 Function 10 – Preset Multiple Registers

This function presets the state of multiple registers to specific values. A typical function 10 command and response is listed below:

#### Command Usage:

Address	One Byte Slave Address
Function	One Byte Function Number
Starting Addr HI	Starting Register Address HI Byte
Starting Addr LO	Starting Register Address LO Byte
Num Registers HI	Number of Registers to Write HI
Num Registers LO	Number of Registers to Write LO
Byte Count	Number of Data Bytes Transmitted
Data HI	Force Data HI
Data LO	Force Data LO

#### Response Message:

Address	One Byte Slave Address	
Function	One Byte Function Number	
Starting Addr HI	Starting Address HI Byte	Same value as in command above.
Starting Addr LO	Starting Address LO Byte	Same value as in command above.
Num Registers HI	Preset Data value HI	Same value as in command above.
Num Registers LO	Preset Data value LO	Same value as in command above.
Error Check	Two Byte CRC	

## 5.2 Modbus Exceptions

The following Modbus Exception (Error Codes) may be returned from the D6000 series modules. These Exception Codes are returned when an error is detected within the command messages transmitted to the module. All Exception Code numbers are indicated below with a detailed description of possible causes.

<b>Modbus Exception Codes</b>		
<b>Exception</b>	<b>Name</b>	<b>Description</b>
01	Illegal Function	This exception code is generated when the module does not recognize the function code.
02	Illegal Data Address	This exception code is generated when the module does not support the specified data address in the command.
03	Illegal Data Value	This exception code is generated if the command data is out of range for the function.
06	Slave Busy	This exception code is generated during the first 3 seconds after the module is reset or powered up.
07	Negative Acknowledge	This exception code is generated if the command tries to write a value into the module EEPROM without being write-enabled first.

**Notes:**