

**Data sheet | Item number: 734-106/008-000**

1-conductor female connector; CAGE CLAMP®; 1.5 mm<sup>2</sup>; Pin spacing 3.5 mm; 6-pole; 100% protected against mismatching; Snap-in mounting feet; 1,50 mm<sup>2</sup>; light gray

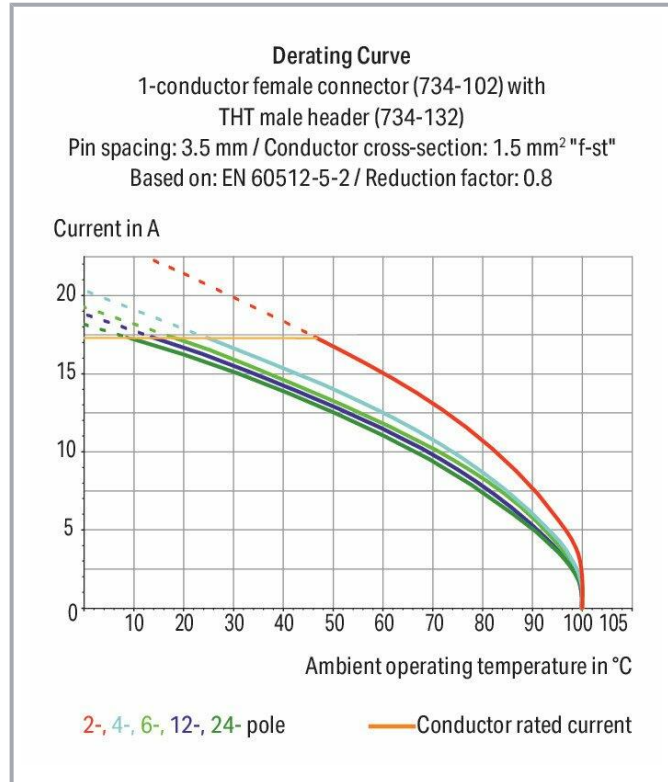

[www.wago.com/734-106/008-000](http://www.wago.com/734-106/008-000)

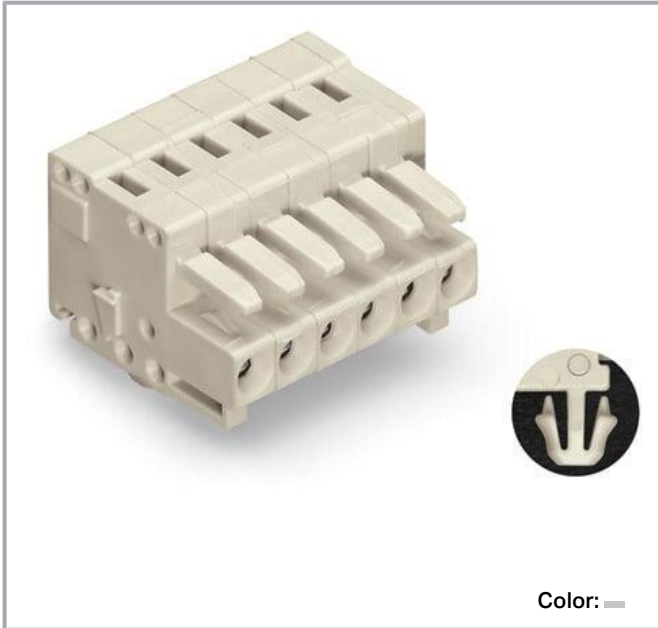

Subject to changes. Please also observe the further product documentation!

WAGO GmbH & Co. KG  
Hansastr. 27  
32423 Minden  
Phone: +49571 887-0 | Fax: +49571 887-169  
Email: [info.de@wago.com](mailto:info.de@wago.com) | Web: [www.wago.com](http://www.wago.com)

Do you have any questions about our products?  
We are always happy to take your call at +49 (571) 887-44222.

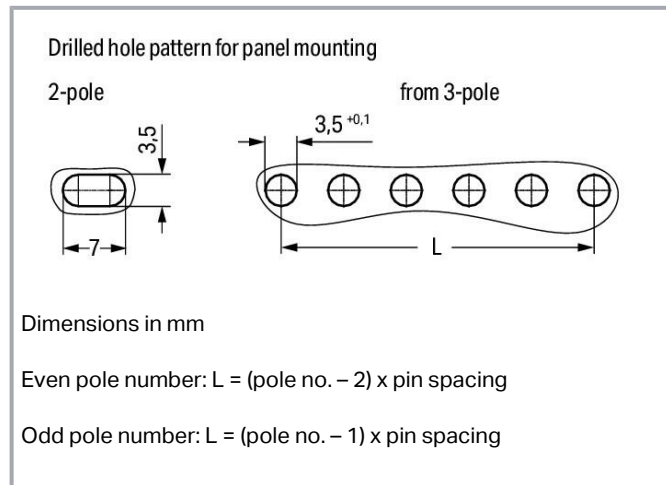
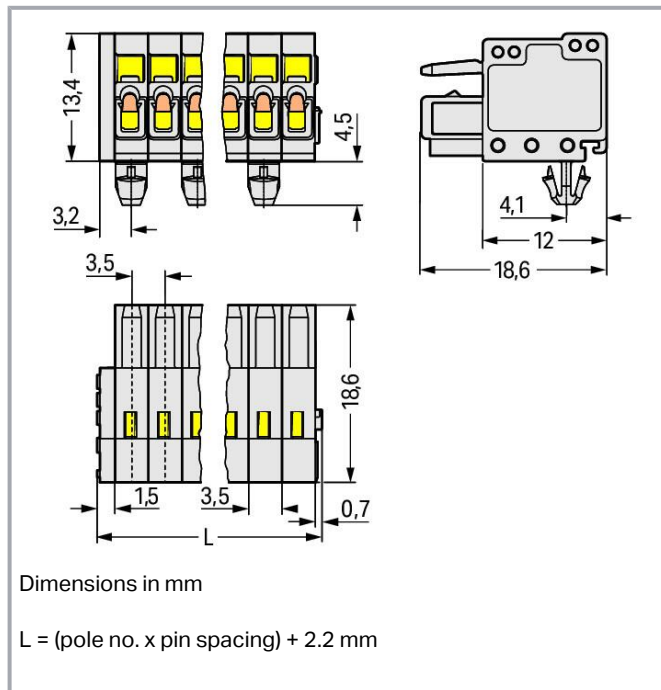

## Item description

- Universal connection for all conductor types
- Easy cable pre-assembly and on-unit wiring via vertical and horizontal CAGE CLAMP® actuation
- Strain relief plates and housings for field assembly
- 100% protected against mismatching
- Coding option available

## Data

### Notes

#### Safety information

The *MCS – MULTI CONNECTION SYSTEM* includes connectors without breaking capacity in accordance with DIN EN 61984. When used as intended, these connectors must not be connected /disconnected when live or under load. When used as intended, these connectors must not be connected/disconnected when live or under load. The circuit design should ensure header pins, which can be touched, are not live when unmated.

#### Variants:

Other pole numbers  
 Gold-plated or partially gold-plated contact surfaces  
 Other versions (or variants) can be requested from WAGO Sales or configured at <https://configurator.wago.com/>.

Subject to changes. Please also observe the further product documentation!

## Electrical data

### Ratings per IEC/EN

Ratings per	IEC/EN 60664-1
Nominal voltage (III/3)	160 V
Rated impulse voltage (III/3)	2.5 kV
Rated voltage (III/2)	160 V
Rated impulse voltage (III/2)	2.5 kV
Nominal voltage (II/2)	320 V
Rated surge voltage (II/2)	2.5 kV
Rated current	10 A
Legend (ratings)	(III / 2) $\hat{=}$ Overvoltage category III / Pollution degree 2

### Ratings per UL 1059

Approvals per	UL 1059
Rated voltage UL (Use Group B)	300 V
Rated current UL (Use Group B)	10 A
Rated voltage UL (Use Group D)	300 V
Rated current UL (Use Group D)	10 A

### Ratings per CSA

Approvals per	CSA
Rated voltage CSA (Use Group B)	300 V
Rated current CSA (Use Group B)	10 A
Rated voltage CSA (Use Group D)	300 V
Rated current CSA (Use Group D)	10 A

## Connection data

Connection points	6
Total number of potentials	6
Number of connection types	1
Number of levels	1

### Connection 1

Connection technology	CAGE CLAMP®
-----------------------	-------------

Subject to changes. Please also observe the further product documentation!



Actuation type	Operating tool
Actuation direction 1	Operation parallel to conductor entry
Actuation direction 2	Operation perpendicular to conductor entry
Solid conductor	0.08 ... 1.5 mm <sup>2</sup> / 28 ... 14 AWG
Fine-stranded conductor	0.08 ... 1.5 mm <sup>2</sup> / 28 ... 14 AWG
Fine-stranded conductor; with insulated ferrule	0.25 ... 1.5 mm <sup>2</sup>
Fine-stranded conductor; with uninsulated ferrule	0.25 ... 1.5 mm <sup>2</sup>
Note (conductor cross-section)	Terminating 1.5 mm <sup>2</sup> conductors is possible; however insulation diameter does not allow clamping units to be terminated in a row.
Strip length	6 ... 7 mm / 0.24 ... 0.28 inches
Pole number	6
Conductor entry direction to mating direction	0°

### Physical data

Pin spacing	3.5 mm / 0.138 inches
Width	23.2 mm / 0.913 inches
Height	18.9 mm / 0.744 inches
Height from the surface	13.4 mm / 0.528 inches
Depth	18.6 mm / 0.732 inches

### Mechanical Data

Variable coding	Yes
Housing sheet thickness	0.6 ... 1.2 mm / 0.024 ... 0.047 inches
Mounting type	Snap-in foot
Mounting type	Panel mounting
Anti-rotation protection	Yes

### Plug-in connection

Contact type (pluggable connector)	Female connector/socket
Connector (connection type)	for conductor
Mismating protection	Yes
Plugging without loss of pin spacing	No
Locking of plug-in connection	none

### Material Data

Note (material data)

[Information on material specifications can be found here](#)

Subject to changes. Please also observe the further product documentation!



Color	light gray
Material group	I
Insulation material	Polyamide (PA66)
Flammability class per UL94	V0
Clamping spring material	Chrome-nickel spring steel (CrNi)
Contact material	Copper alloy
Contact plating	Tin
Fire load	0.079 MJ
Weight	4.7 g

### Environmental requirements

Limit temperature range	-60 ... +100 °C
Processing temperature	-35 ... +60 °C

### Commercial data

Product Group	3 (Multi Conn. System)
eCl@ss 10.0	27-44-03-09
eCl@ss 9.0	27-44-03-09
ETIM 8.0	EC002638
ETIM 7.0	EC002638
PU (SPU)	100 pcs
Packaging type	box
Country of origin	DE
GTIN	4045454930691
Customs tariff number	85366990990

### Environmental Product Compliance

RoHS Compliance Status	Compliant, No Exemption
------------------------	-------------------------

### Approvals / Certificates

#### General approvals



Logo	Approval	Additional Approval Text	Certificate name
	UL Underwriters Laboratories Inc.	UL 1059	E45172

Subject to changes. Please also observe the further product documentation!

## Declarations of conformity and manufacturer's declarations

Logo	Approval	Additional Approval Text	Certificate name
	<b>Railway</b> WAGO GmbH & Co. KG	-	Railway Ready

## Approvals for marine applications

Logo	Approval	Additional Approval Text	Certificate name
 	<b>BV</b> Bureau Veritas S.A.	IEC 60998	11915/DO BV
	<b>DNV GL</b> Det Norske Veritas, Germanischer Lloyd	-	TAE000016Z





## Counterpart

**Item no. 734-306**

1-conductor male connector; CAGE CLAMP®; 1.5 mm<sup>2</sup>; Pin spacing 3.5 mm; 6-pole; 100% protected against mismatching; 1,50 mm<sup>2</sup>; light gray

[www.wago.com/734-306](http://www.wago.com/734-306)

## Optional accessories

Ferrule		
Ferrule		
	<b>Item no.: 216-101</b> Ferrule; Sleeve for 0.5 mm <sup>2</sup> / AWG 22; uninsulated; electro-tin plated; silver-colored	<a href="http://www.wago.com/216-101">www.wago.com/216-101</a>
	<b>Item no.: 216-104</b> Ferrule; Sleeve for 1.5 mm <sup>2</sup> / AWG 16; uninsulated; electro-tin plated; silver-colored	<a href="http://www.wago.com/216-104">www.wago.com/216-104</a>
	<b>Item no.: 216-102</b> Ferrule; Sleeve for 0.75 mm <sup>2</sup> / AWG 20; uninsulated; electro-tin plated; silver-colored	<a href="http://www.wago.com/216-102">www.wago.com/216-102</a>
	<b>Item no.: 216-103</b> Ferrule; Sleeve for 1 mm <sup>2</sup> / AWG 18; uninsulated; electro-tin plated	<a href="http://www.wago.com/216-103">www.wago.com/216-103</a>
	<b>Item no.: 216-123</b> Ferrule; Sleeve for 1 mm <sup>2</sup> / AWG 18; uninsulated; electro-tin plated; silver-colored	<a href="http://www.wago.com/216-123">www.wago.com/216-123</a>

Subject to changes. Please also observe the further product documentation!

WAGO GmbH & Co. KG  
Hansastr. 27  
32423 Minden  
Phone: +49571 887-0 | Fax: +49571 887-169  
Email: [info.de@wago.com](mailto:info.de@wago.com) | Web: [www.wago.com](http://www.wago.com)

Do you have any questions about our products?  
We are always happy to take your call at +49 (571) 887-44222.



Item no.: 216-122 Ferrule; Sleeve for 0.75 mm <sup>2</sup> / AWG 20; uninsulated; electro-tin plated; silver-colored	<a href="http://www.wago.com/216-122">www.wago.com/216-122</a>
Item no.: 216-124 Ferrule; Sleeve for 1.5 mm <sup>2</sup> / AWG 16; uninsulated; electro-tin plated	<a href="http://www.wago.com/216-124">www.wago.com/216-124</a>
Item no.: 216-142 Ferrule; Sleeve for 0.75 mm <sup>2</sup> / 18 AWG; uninsulated; electro-tin plated; electrolytic copper; gastight crimped; acc. to DIN 46228, Part 1/08.92	<a href="http://www.wago.com/216-142">www.wago.com/216-142</a>
Item no.: 216-132 Ferrule; Sleeve for 0.34 mm <sup>2</sup> / AWG 24; uninsulated; electro-tin plated	<a href="http://www.wago.com/216-132">www.wago.com/216-132</a>
Item no.: 216-121 Ferrule; Sleeve for 0.5 mm <sup>2</sup> / AWG 22; uninsulated; electro-tin plated; silver-colored	<a href="http://www.wago.com/216-121">www.wago.com/216-121</a>
Item no.: 216-143 Ferrule; Sleeve for 1 mm <sup>2</sup> / AWG 18; uninsulated; electro-tin plated; electrolytic copper; gastight crimped; acc. to DIN 46228, Part 1/08.92	<a href="http://www.wago.com/216-143">www.wago.com/216-143</a>
Item no.: 216-131 Ferrule; Sleeve for 0.25 mm <sup>2</sup> / AWG 24; uninsulated; electro-tin plated; silver-colored	<a href="http://www.wago.com/216-131">www.wago.com/216-131</a>
Item no.: 216-141 Ferrule; Sleeve for 0.5 mm <sup>2</sup> / 20 AWG; uninsulated; electro-tin plated; electrolytic copper; gastight crimped; acc. to DIN 46228, Part 1/08.92	<a href="http://www.wago.com/216-141">www.wago.com/216-141</a>
Item no.: 216-152 Ferrule; Sleeve for 0.34 mm <sup>2</sup> / AWG 24; uninsulated; electro-tin plated	<a href="http://www.wago.com/216-152">www.wago.com/216-152</a>
Item no.: 216-203 Ferrule; Sleeve for 1 mm <sup>2</sup> / AWG 18; insulated; electro-tin plated; red	<a href="http://www.wago.com/216-203">www.wago.com/216-203</a>
Item no.: 216-202 Ferrule; Sleeve for 0.75 mm <sup>2</sup> / 18 AWG; insulated; electro-tin plated; gray	<a href="http://www.wago.com/216-202">www.wago.com/216-202</a>
Item no.: 216-151 Ferrule; Sleeve for 0.25 mm <sup>2</sup> / AWG 24; uninsulated; electro-tin plated	<a href="http://www.wago.com/216-151">www.wago.com/216-151</a>
Item no.: 216-204 Ferrule; Sleeve for 1.5 mm <sup>2</sup> / AWG 16; insulated; electro-tin plated; black	<a href="http://www.wago.com/216-204">www.wago.com/216-204</a>
Item no.: 216-144 Ferrule; Sleeve for 1.5 mm <sup>2</sup> / AWG 16; uninsulated; electro-tin plated; electrolytic copper; gastight crimped; acc. to DIN 46228, Part 1/08.92; silver-colored	<a href="http://www.wago.com/216-144">www.wago.com/216-144</a>
Item no.: 216-201 Ferrule; Sleeve for 0.5 mm <sup>2</sup> / 20 AWG; insulated; electro-tin plated; white	<a href="http://www.wago.com/216-201">www.wago.com/216-201</a>
Item no.: 216-223 Ferrule; Sleeve for 1 mm <sup>2</sup> / AWG 18; insulated; electro-tin plated; red	<a href="http://www.wago.com/216-223">www.wago.com/216-223</a>
Item no.: 216-241 Ferrule; Sleeve for 0.5 mm <sup>2</sup> / 20 AWG; insulated; electro-tin plated; electrolytic copper; gastight crimped; acc. to DIN 46228, Part 4/09.90; white	<a href="http://www.wago.com/216-241">www.wago.com/216-241</a>
Item no.: 216-242	

Subject to changes. Please also observe the further product documentation!

	Ferrule; Sleeve for 0.75 mm <sup>2</sup> / 18 AWG; insulated; electro-tin plated; electrolytic copper; gastight crimped; acc. to DIN 46228, Part 4/09.90; gray	<a href="http://www.wago.com/216-242">www.wago.com/216-242</a>
	<b>Item no.: 216-222</b> Ferrule; Sleeve for 0.75 mm <sup>2</sup> / 18 AWG; insulated; electro-tin plated; gray	<a href="http://www.wago.com/216-222">www.wago.com/216-222</a>
	<b>Item no.: 216-221</b> Ferrule; Sleeve for 0.5 mm <sup>2</sup> / 20 AWG; insulated; electro-tin plated; white	<a href="http://www.wago.com/216-221">www.wago.com/216-221</a>
	<b>Item no.: 216-224</b> Ferrule; Sleeve for 1.5 mm <sup>2</sup> / AWG 16; insulated; electro-tin plated; black	<a href="http://www.wago.com/216-224">www.wago.com/216-224</a>
	<b>Item no.: 216-243</b> Ferrule; Sleeve for 1 mm <sup>2</sup> / AWG 18; insulated; electro-tin plated; electrolytic copper; gastight crimped; acc. to DIN 46228, Part 4/09.90; red	<a href="http://www.wago.com/216-243">www.wago.com/216-243</a>
	<b>Item no.: 216-244</b> Ferrule; Sleeve for 1.5 mm <sup>2</sup> / AWG 16; insulated; electro-tin plated; electrolytic copper; gastight crimped; acc. to DIN 46228, Part 4/09.90; black	<a href="http://www.wago.com/216-244">www.wago.com/216-244</a>
	<b>Item no.: 216-263</b> Ferrule; Sleeve for 1 mm <sup>2</sup> / AWG 18; insulated; electro-tin plated; electrolytic copper; gastight crimped; acc. to DIN 46228, Part 4/09.90; red	<a href="http://www.wago.com/216-263">www.wago.com/216-263</a>
	<b>Item no.: 216-264</b> Ferrule; Sleeve for 1.5 mm <sup>2</sup> / AWG 16; insulated; electro-tin plated; electrolytic copper; gastight crimped; acc. to DIN 46228, Part 4/09.90; black	<a href="http://www.wago.com/216-264">www.wago.com/216-264</a>
	<b>Item no.: 216-284</b> Ferrule; Sleeve for 1.5 mm <sup>2</sup> / AWG 16; insulated; electro-tin plated; electrolytic copper; gastight crimped; acc. to DIN 46228, Part 4/09.90; black	<a href="http://www.wago.com/216-284">www.wago.com/216-284</a>
	<b>Item no.: 216-262</b> Ferrule; Sleeve for 0.75 mm <sup>2</sup> / 18 AWG; insulated; electro-tin plated; electrolytic copper; gastight crimped; acc. to DIN 46228, Part 4/09.90; gray	<a href="http://www.wago.com/216-262">www.wago.com/216-262</a>
	<b>Item no.: 216-301</b> Ferrule; Sleeve for 0.25 mm <sup>2</sup> / AWG 24; insulated; electro-tin plated; yellow	<a href="http://www.wago.com/216-301">www.wago.com/216-301</a>
	<b>Item no.: 216-321</b> Ferrule; Sleeve for 0.25 mm <sup>2</sup> / AWG 24; insulated; electro-tin plated; yellow	<a href="http://www.wago.com/216-321">www.wago.com/216-321</a>
	<b>Item no.: 216-322</b> Ferrule; Sleeve for 0.34 mm <sup>2</sup> / 22 AWG; insulated; electro-tin plated; light turquoise	<a href="http://www.wago.com/216-322">www.wago.com/216-322</a>
	<b>Item no.: 216-302</b> Ferrule; Sleeve for 0.34 mm <sup>2</sup> / 22 AWG; insulated; electro-tin plated; light turquoise	<a href="http://www.wago.com/216-302">www.wago.com/216-302</a>
<b>Strain relief</b>		
Strain relief housing		
	<b>Item no.: 734-606</b> Strain relief housing; for female and male connectors; 2 parts; Pin spacing 3.5 mm; 6-pole; light gray	<a href="http://www.wago.com/734-606">www.wago.com/734-606</a>
Strain relief plate		

Subject to changes. Please also observe the further product documentation!





**Item no.: 734-128**

Strain relief plate; for female and male connectors; 12.5 mm wide; 1 part; Pin spacing 3.5 mm; light gray

[www.wago.com/734-128](http://www.wago.com/734-128)

## Testing and measuring

### Testing accessories



**Item no.: 735-500**

WAGO Test pin; 1 mm Ø; 30 V AC / 60 V DC; CAT0; 1 A; 6 mm uninsulated; Test lead for soldering up to 0,5mm<sup>2</sup>

[www.wago.com/735-500](http://www.wago.com/735-500)

## Insulation stop

### Insulation stop



**Item no.: 734-671**

Insulation stop; 0.08 - 0.2 mm<sup>2</sup> "s" (0.14 mm<sup>2</sup> "f-st"); 8 pieces/strip; light gray

[www.wago.com/734-671](http://www.wago.com/734-671)

## Marking accessories

### Marking strip



**Item no.: 210-332/350-202**

Marking strips; as a DIN A4 sheet; MARKED; 1-16 (240x); Height of marker strip: 3 mm; Strip length 182 mm; Horizontal marking; Self-adhesive; white

[www.wago.com/210-332/350-202](http://www.wago.com/210-332/350-202)



**Item no.: 210-332/350-206**

Marking strips; as a DIN A4 sheet; MARKED; 33-48 (240x); Height of marker strip: 3 mm; Strip length 182 mm; Horizontal marking; Self-adhesive; white

[www.wago.com/210-332/350-206](http://www.wago.com/210-332/350-206)



**Item no.: 210-332/350-204**

Marking strips; as a DIN A4 sheet; MARKED; 17-32 (240x); Height of marker strip: 3 mm; Strip length 182 mm; Horizontal marking; Self-adhesive; white

[www.wago.com/210-332/350-204](http://www.wago.com/210-332/350-204)

## Tool

### Operating tool



**Item no.: 210-250**

Operating tool; for MCS MINI and MIDI with CAGE CLAMP® connection; red

[www.wago.com/210-250](http://www.wago.com/210-250)



**Item no.: 210-251**

Operating tool; for MCS MICRO and MINI with CAGE CLAMP® connection; yellow

[www.wago.com/210-251](http://www.wago.com/210-251)



**Item no.: 210-647**

Operating tool; Blade: 2.5 x 0.4 mm; with a partially insulated shaft; multicoloured

[www.wago.com/210-647](http://www.wago.com/210-647)



**Item no.: 210-719**

Operating tool; Blade: 2.5 x 0.4 mm; with a partially insulated shaft

[www.wago.com/210-719](http://www.wago.com/210-719)



**Item no.: 734-230**

Operating tool; made of insulating material; 1-way; white

[www.wago.com/734-230](http://www.wago.com/734-230)

Subject to changes. Please also observe the further product documentation!

WAGO GmbH & Co. KG

Hansastr. 27



32423 Minden

Phone: +49571 887-0 | Fax: +49571 887-169

Email: [info.de@wago.com](mailto:info.de@wago.com) | Web: [www.wago.com](http://www.wago.com)

Do you have any questions about our products?

We are always happy to take your call at +49 (571) 887-44222.

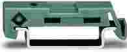
	<p><b>Item no.: 734-190</b> Combination operating tool; natural</p>	<a href="http://www.wago.com/734-190">www.wago.com/734-190</a>
	<p><b>Item no.: 734-191</b> Operating tool; made of insulating material; 1-way; loose; black</p>	<a href="http://www.wago.com/734-191">www.wago.com/734-191</a>
	<p><b>Item no.: 734-231</b> Operating tool; black</p>	<a href="http://www.wago.com/734-231">www.wago.com/734-231</a>
<b>Mounting</b>		
Mounting accessories		
	<p><b>Item no.: 209-137</b> Mounting adapter; can be used as end stop; 6.5 mm wide; gray</p>	<a href="http://www.wago.com/209-137">www.wago.com/209-137</a>

## Downloads

### Documentation

#### Additional Information

Technical Section	2019 Apr 3	pdf	Download
Technical explanations		2.0 MB	

## CAD/CAE-Data

### CAD data

2D/3D Models 734-106/008-000	URL	Download
------------------------------	-----	----------

### CAE data

ZUKEN Portal 734-106/008-000	URL	Download
------------------------------	-----	----------

## Environmental Product Compliance

### Compliance Search

Environmental Product Compliance 734-106/008-000	URL	Download
1-conductor female connector; CAGE CLAMP®; 1.5 mm <sup>2</sup> ; Pin spacing 3.5 mm; 6-pole; 100% protected against mismatching; Snap-in mounting feet; 1,50 mm <sup>2</sup> ; light gray		

Subject to changes. Please also observe the further product documentation!

## Installation Notes

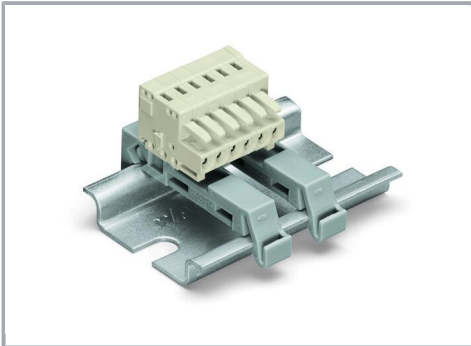

Using two DIN-35 rail mounting adapters (209-137) for 3 or more poles; distance between two mounting adapters: maximum 7 poles

## Conductor termination



Inserting a conductor via (2.5 x 0.4) mm screwdriver – CAGE CLAMP® actuation perpendicular to conductor entry.

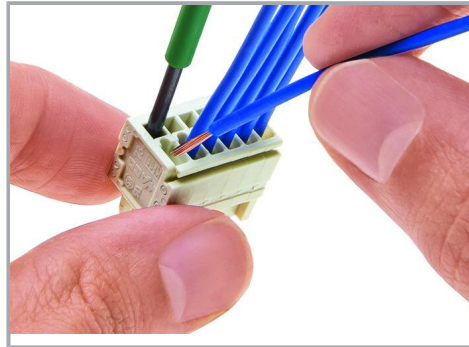

Inserting a conductor via (2.5 x 0.4) mm screwdriver – CAGE CLAMP® actuation parallel to conductor entry.

Subject to changes. Please also observe the further product documentation!

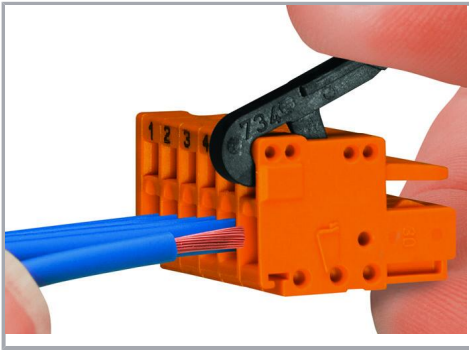

Inserting a conductor into CAGE CLAMP® unit via operating tool (734-191).

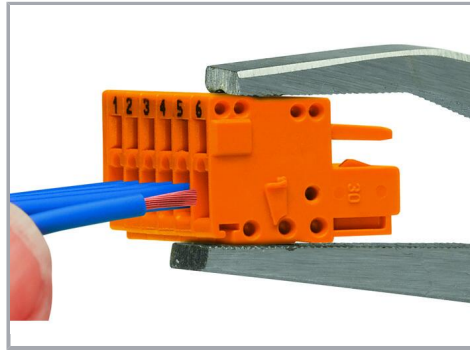

Inserting a conductor into CAGE CLAMP® unit via operating tool (210-251 or 210-250).

### Coding

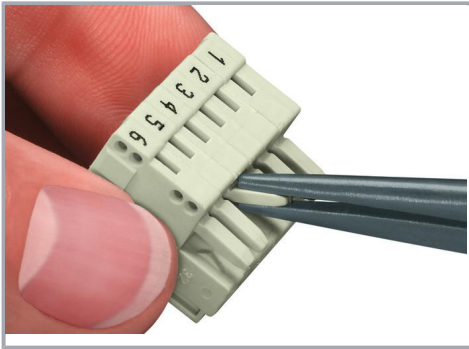

Coding a female connector – removing coding finger(s).

### Testing

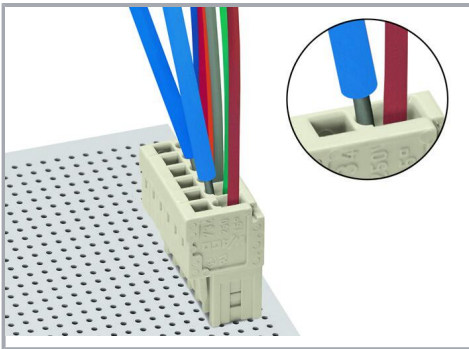

Testing via 1 mm Ø test pin (735-500) – CAGE CLAMP® connection – touch contact.

### Marking

Subject to changes. Please also observe the further product documentation!

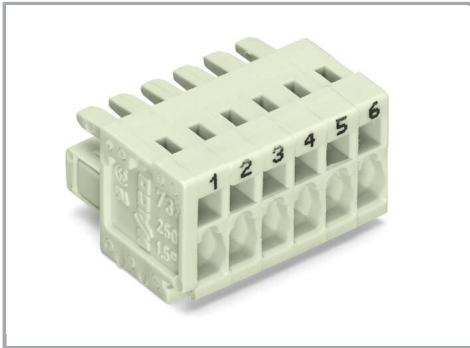

Labeling via direct marking or self-adhesive strips.

### Installation

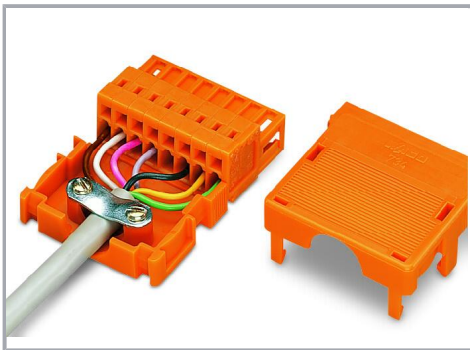

Strain relief housing for 734 Series Male and Female Connectors with CAGE CLAMP® connection

### Product family

**MCS MINI**

[Show all products from the family](#)

Subject to changes. Please also observe the further product documentation!