

# PXF40-xxTxx Triple Output DC/DC Converters

9 to 18 Vdc and 18 to 36 Vdc and 36 to 75 Vdc input, 3.3 to  $\pm 15$  Vdc Triple Output, 40W



## APPLICATIONS

Wireless Network  
Telecom/Datacom  
Industrial Control  
Test & Measurement  
Semiconductor Equipment

## Features

- Triple output current up to 6A
- 40 watts maximum output power
- 2:1 wide input voltage range
- Six-sided continuous shield
- High efficiency up to 88%
- Low profile: 2.00×2.00×0.40 inch (50.8×50.8×10.2 mm )
- Fixed switching frequency
- RoHS compliant
- Input to output isolation: 1600Vdc, min
- Over-temperature protection
- Input under-voltage protection
- Output over-voltage protection
- Over-current protection, auto-recovery
- Output short circuit protection, auto-recovery
- Remote ON/OFF

## Options

- Heat sinks available for extended operation

## General Description

The PXF40xxTxxx series offers 40 watts of output power from a 2 x 2 x 0.4 inch package. It has a 2:1 wide input voltage range of 9-18VDC, 18-36VDC and 36-75VDC and features 1600VDC of isolation, short-circuit and over-voltage protection.

## Table of Contents

Absolute Maximum Ratings	P2	Thermal Consideration	P33
Output Specification	P2	Heat Sink Consideration	P34
Input Specification	P3	Remote ON/OFF Control	P35
General Specification	P4	Mechanical Data	P36
Characteristic Curves	P5	Recommended Pad Layout	P37
Test Configurations	P29	Soldering and Reflow Consideration	P38
EMC Consideration	P30	Packaging Information	P39
Input Source Impedance	P32	Part Number Structure	P39
Output Over Current Protection	P32	Safety and Installation Instruction	P40
Output Over Voltage Protection	P33	MTBF and Reliability	P40
Short Circuit Protection	P33		

Absolute Maximum Rating				
Parameter	Model	Min	Max	Unit
Input Voltage Continuous	12Txxx		18	Vdc
	24Txxx		36	
	48Txxx		75	
Transient (100ms)	12Txxx		36	
	24Txxx		50	
	48Txxx		100	
Operating Ambient Temperature (with derating)	All	-40	85	°C
Operating Case Temperature	All		100	°C
Storage Temperature	All	-55	105	°C

Output Specification					
Parameter	Model	Min	Typ	Max	Unit
Output Voltage ( $V_{in} = V_{in(nom)}$ ; Full Load ; $T_A=25^{\circ}C$ )	xxT3312	3.267 $\pm$ 11.4	3.3 $\pm$ 12	3.333 $\pm$ 12.6	Vdc
	xxT3315	3.267 $\pm$ 14.25	3.3 $\pm$ 15	3.333 $\pm$ 15.75	
	xxT0512	4.95 $\pm$ 11.4	5 $\pm$ 12	5.05 $\pm$ 12.6	
	xxT0515	4.95 $\pm$ 14.25	5 $\pm$ 15	5.05 $\pm$ 15.75	
Output Regulation Line ( $V_{in(min)}$ to $V_{in(max)}$ at Full Load)  Load (Min. to 100% of Full Load)	Main	-1		+1	%
	Auxiliary	-5		+5	
	Main	-2		+2	
	Auxiliary	-5		+5	
Output Ripple & Noise (See Page 29) Peak-to-Peak (20MHz bandwidth) (Measured with a 0.1 $\mu$ F/50V MLCC)	All		50 / 75		mVp-p
Temperature Coefficient	All	-0.02		+0.02	%/ $\square$
Output Voltage Overshoot ( $V_{in(min)}$ to $V_{in(max)}$ ; Full Load ; $T_A=25^{\circ}C$ )	All		0	5	% $V_b$
Dynamic Load Response ( $V_{in} = V_{in(nom)}$ ; $T_A=25^{\circ}C$ $\square$ ) Load step change from 75% to 100% or 100 to 75% of Full Load Peak Deviation Settling Time ( $V_{out} < 10\%$ peak deviation)	All		250		mV
	All		250		$\mu$ S
Output Current	xxT3312	600 $\pm$ 40		6000 / $\pm$ 400	mA
	xxT3315	600 $\pm$ 30		6000 / $\pm$ 300	
	xxT0512	600 $\pm$ 40		6000 / $\pm$ 400	
	xxT0515	600 $\pm$ 30		6000 / $\pm$ 300	
Output Over Voltage Protection (Zener diode clamp)	xxT3312		3.9/15		Vdc
	xxT3315		3.9/18		
	xxT0512		6.2/15		
	xxT0515		6.2/18		
Output Over Current Protection	All			150	% FL.
Output Short Circuit Protection	All	Hiccup, automatic recovery			

Input Specification						
Parameter	Model	Min	Typ	Max	Unit	
Operating Input Voltage	12Txxx	9	12	18	Vdc	
	24Txxx	18	24	36		
	48Txxx	36	48	75		
Input Current (Maximum value at $V_{in} = V_{in(nom)}$ ; Full Load)	12T3312			3063	mA	
	12T3315			3000		
	12T0512			4024		
	12T0515			3963		
	24T3312			1512		
	24T3315			1481		
	24T0512			1989		
	24T0515			1958		
	48T3312			747		
	48T3315			732		
	48T0512			982		
48T0515			967			
Input Standby Current (Typical value at $V_{in} = V_{in(nom)}$ ; No Load)	12T3312		215		mA	
	12T3315		230			
	12T0512		280			
	12T0515		255			
	24T3312		65			
	24T3315		65			
	24T0512		60			
	24T0515		75			
	48T3312		35			
	48T3315		35			
	48T0512		30			
48T0515		40				
Under Voltage Lockout Turn-on Threshold	12Txxx			9	Vdc	
	24Txxx			17.8		
	48Txxx			36		
Under Voltage Lockout Turn-off Threshold	12Txxx		8		Vdc	
	24Txxx		16			
	48Txxx		34			
Input Reflected Ripple Current (See Page 29) (5 to 20MHz, 12 $\mu$ H Source Impedance)	All		40		mAp-p	
Start Up Time ( $V_{in} = V_{in(nom)}$ and Constant Resistive Load)	All			25	mS	
						Power Up
						Remote ON/OFF
Remote ON/OFF Control (See Page 35) (The ON/OFF pin voltage is referenced to $-V_{IN}$ )	All	3.5		12	Vdc	
						Positive Logic DC-DC ON
						DC-DC OFF
DC-DC OFF	0			1.2		
Remote Off Input Current	All		2.5		mA	
Input Current of Remote Control Pin	All	-0.5		+0.5	mA	

General Specification					
Parameter	Model	Min	Typ	Max	Unit
Efficiency (See Page 29) ( $V_{in} = V_{in(nom)}$ ; Full Load ; $T_A=25^{\circ}C$ )	12T3312		84		%
	12T3315		84		
	12T0512		86		
	12T0515		86		
	24T3312		85		
	24T3315		85		
	24T0512		87		
	24T0515		87		
	48T3312		86		
	48T3315		86		
	48T0512		88		
	48T0515		88		
Isolation Voltage Input to Output Input to Case, Output to Case	All	1600 1600			Vdc
Isolation Resistance	All	1			GΩ
Isolation Capacitance	All			1000	pF
Switching Frequency	All		300		KHz
Weight	All		60		g
MTBF(See Page 41 ) Bellcore TR-NWT-000332, $T_C=40^{\circ}C$ □ MIL-HDBK-217F	All		$1.398 \times 10^6$ $3.585 \times 10^5$		hours
Over Temperature Protection	All		115		$^{\circ}C$

Characteristic Curves

All test conditions are at 25°C. The figures are for PXF40-12T3312

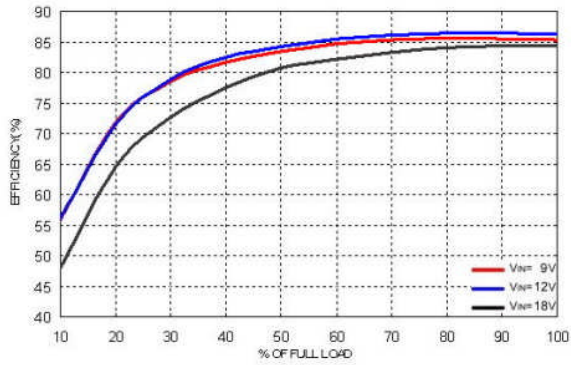

Efficiency Versus Output Current

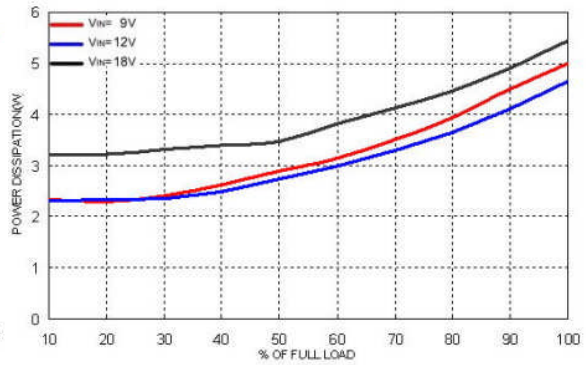

Power Dissipation Versus Output Current

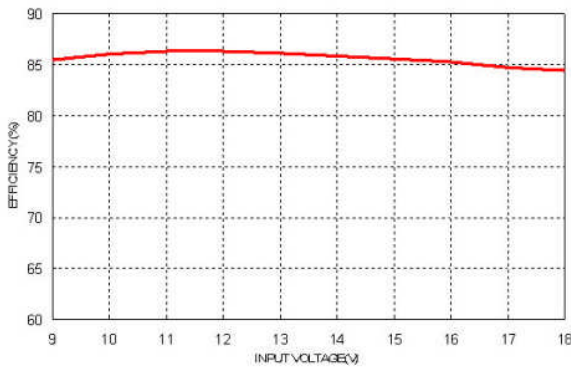

Efficiency Versus Input Voltage. Full Load

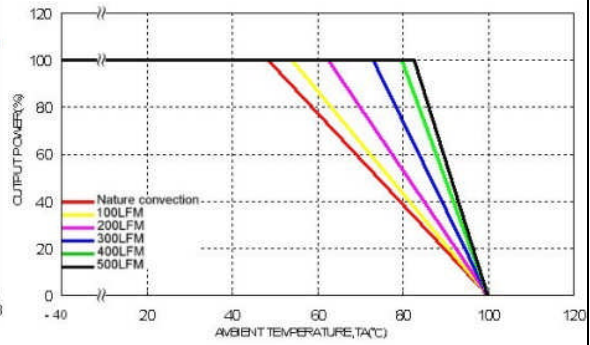

Derating Output Current Versus Ambient Temperature and Airflow Vin = Vin(nom)

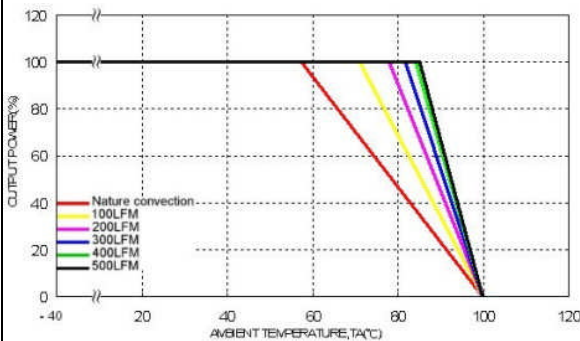

Derating Output Current Versus Ambient Temperature with Heat-Sink and Airflow, Vin = Vin(nom)

Characteristic Curves (Continued)

All test conditions are at 25°C. The figures are for PXF40-12T3312

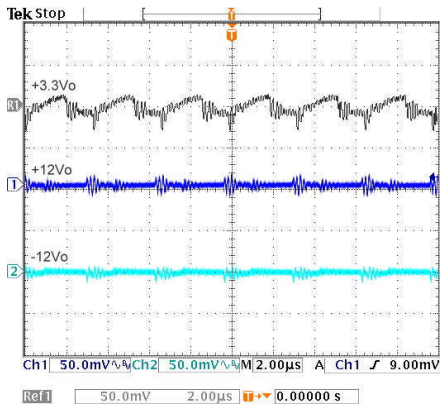

Typical Output Ripple and Noise.  
Vin = Vin(nom), Full Load

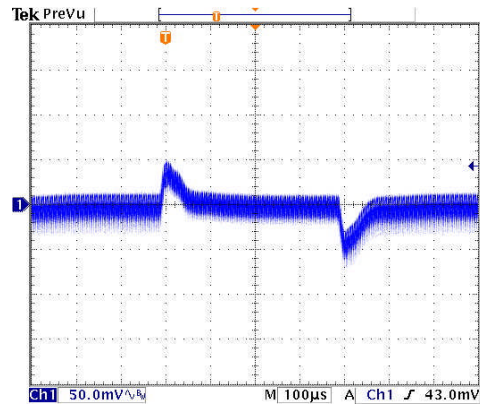

Transient Response to Dynamic Load Change from 100% to 75% to 100% of Full Load ; Vin = Vin(nom)

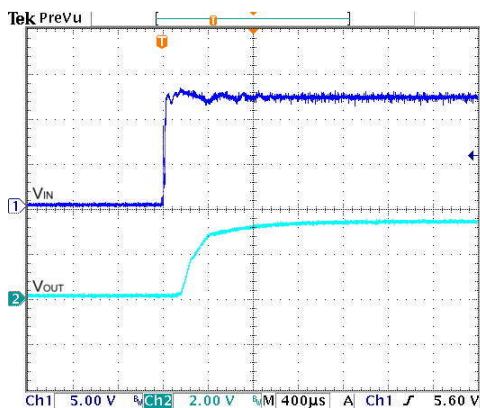

Typical Input Start-Up and Output Rise Characteristic  
Vin = Vin(nom), Full Load

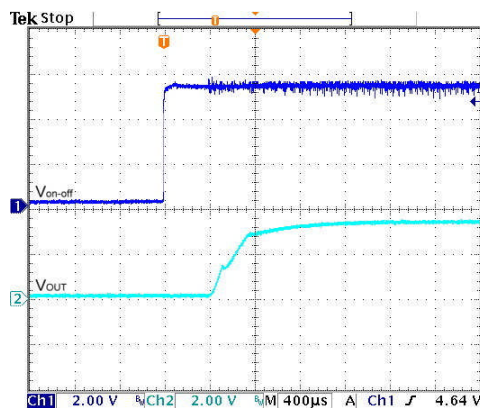

Using ON/OFF Voltage Start-Up and Vo Rise Characteristic  
Vin = Vin(nom), Full Load

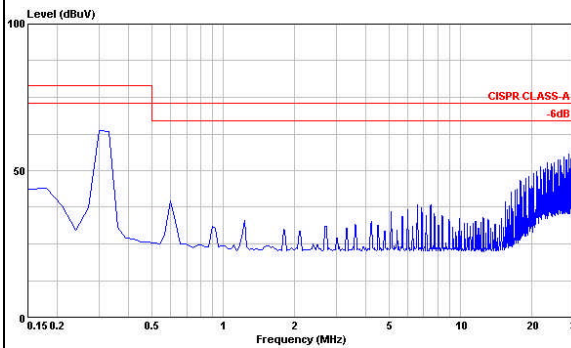

Conduction Emission of EN55022 Class A  
Vin = Vin(nom), Full Load

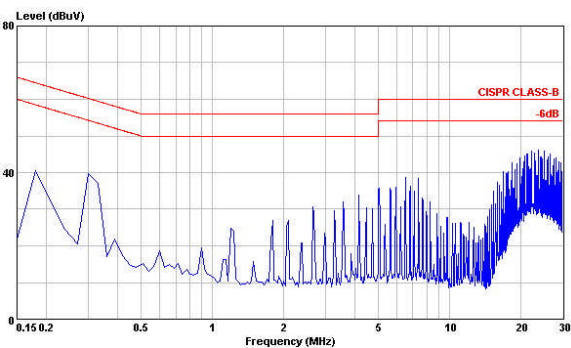

Conduction Emission of EN55022 Class B  
Vin = Vin(nom), Full Load

Characteristic Curves (Continued)

All test conditions are at 25°C. The figures are for PXF40-12T3315

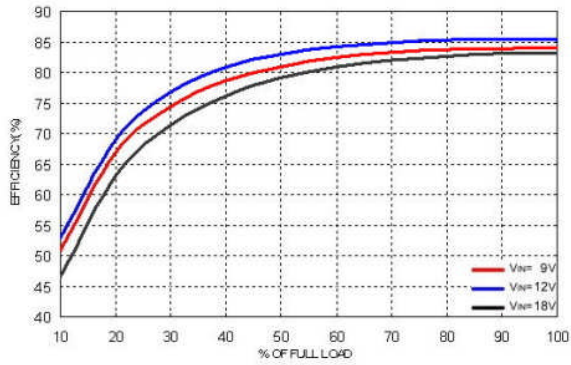

Efficiency Versus Output Current

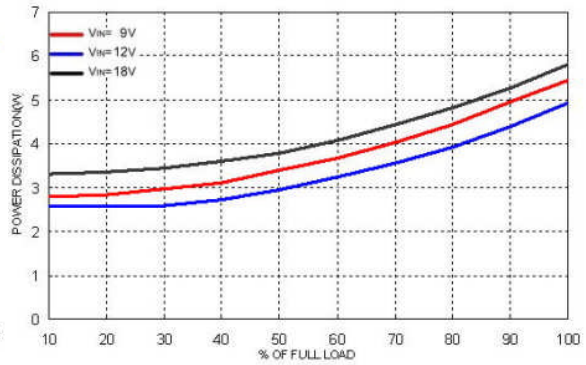

Power Dissipation Versus Output Current

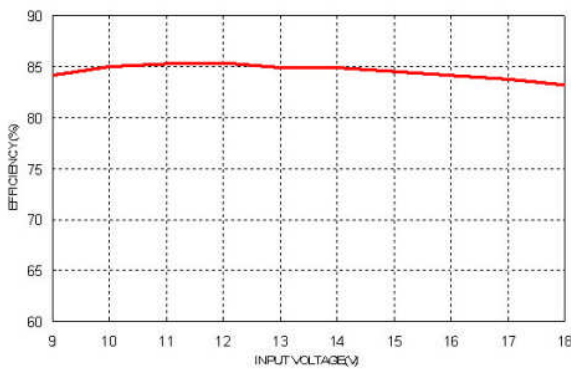

Efficiency Versus Input Voltage. Full Load

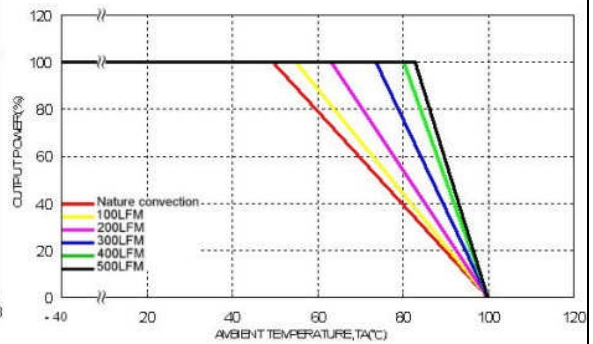

Derating Output Current Versus Ambient Temperature and Airflow Vin=Vin(nom)

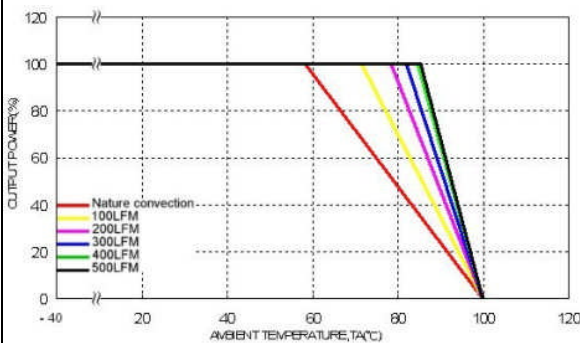

Derating Output Current Versus Ambient Temperature with Heat-Sink and Airflow, Vin = Vin(nom)

Characteristic Curves (Continued)

All test conditions are at 25°C. The figures are for PXF40-12T3315

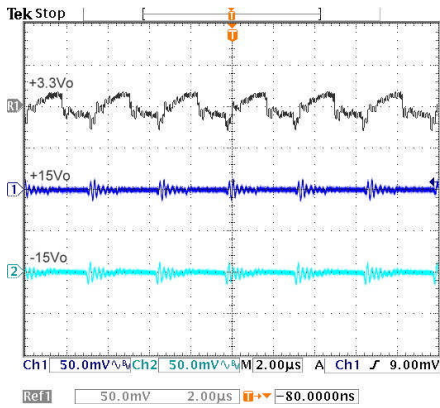

Typical Output Ripple and Noise.  
Vin=Vin(nom), Full Load

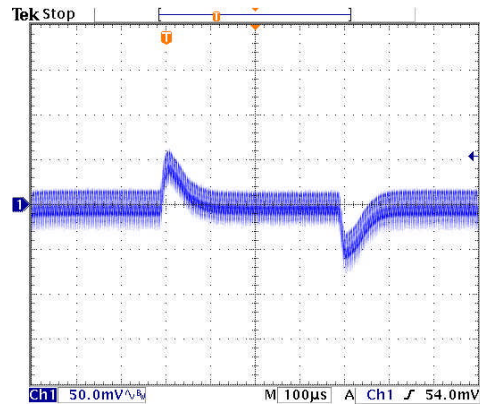

Transient Response to Dynamic Load Change from 100% to 75% to 100% of Full Load ; Vin=Vin(nom)

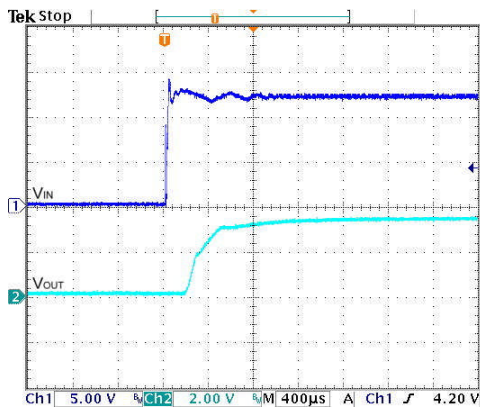

Typical Input Start-Up and Output Rise Characteristic  
Vin=Vin(nom), Full Load

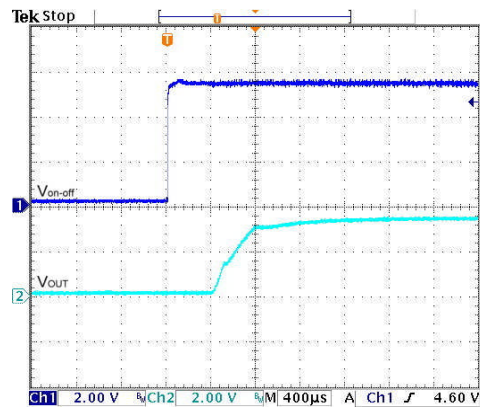

Using ON/OFF Voltage Start-Up and Vo Rise Characteristic  
Vin=Vin(nom), Full Load

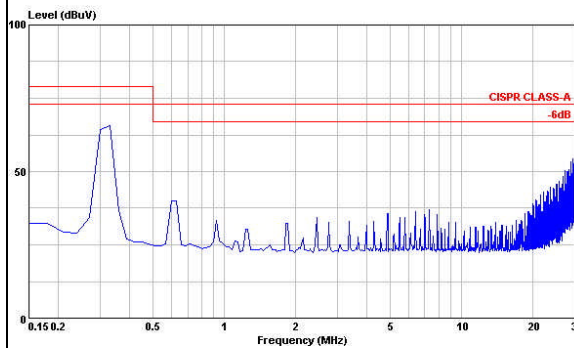

Conduction Emission of EN55022 Class A  
Vin=Vin(nom), Full Load

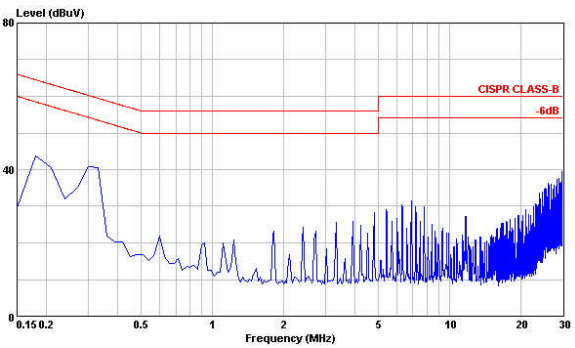

Conduction Emission of EN55022 Class B  
Vin=Vin(nom), Full Load



Characteristic Curves (Continued)

All test conditions are at 25°C. The figures are for PXF40-12T0512

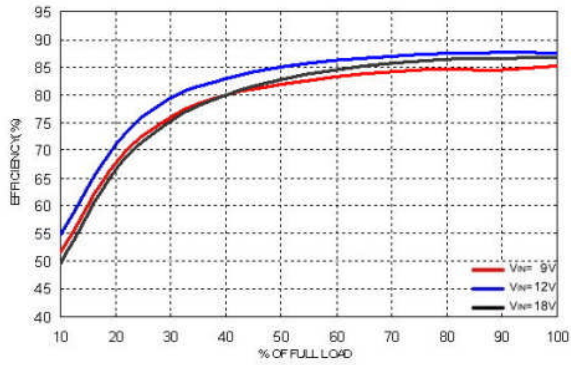

Efficiency Versus Output Current

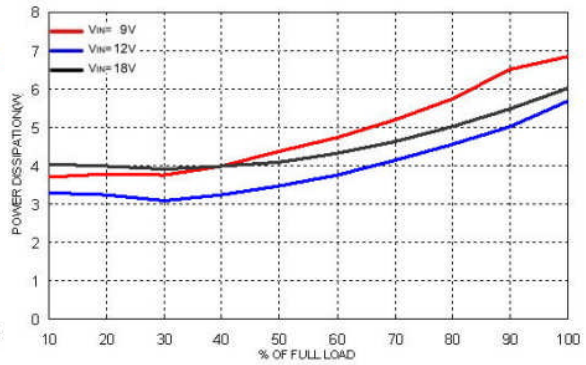

Power Dissipation Versus Output Current

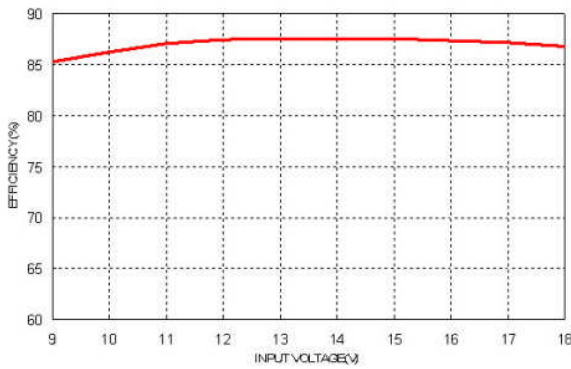

Efficiency Versus Input Voltage. Full Load

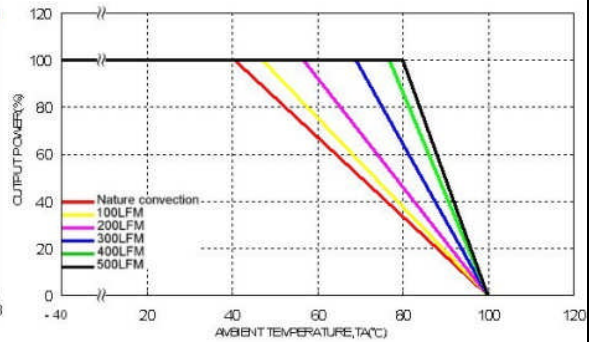

Derating Output Current Versus Ambient Temperature and Airflow Vin=Vin(nom)

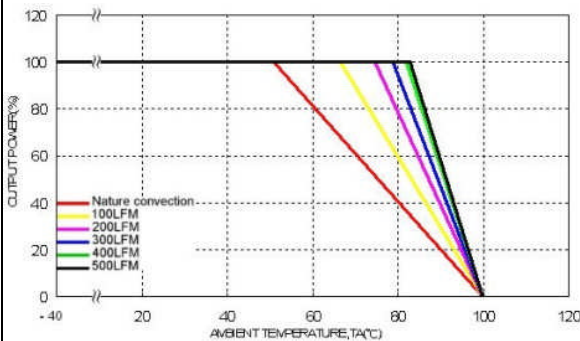

Derating Output Current Versus Ambient Temperature with Heat-Sink and Airflow, Vin = Vin(nom)

Characteristic Curves (Continued)

All test conditions are at 25°C. The figures are for PXF40-12T0512

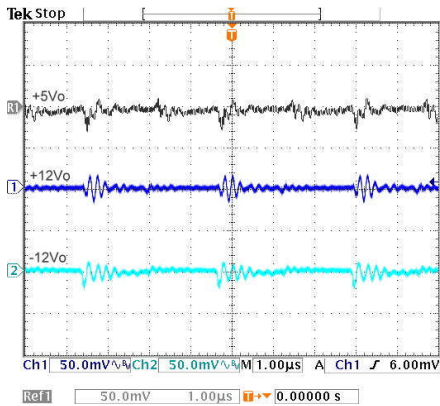

Typical Output Ripple and Noise.  
Vin=Vin(nom), Full Load

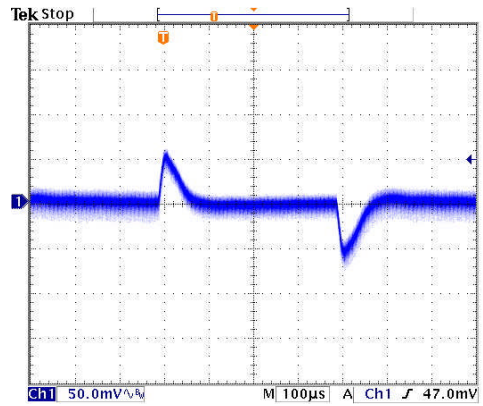

Transient Response to Dynamic Load Change from  
100% to 75% to 100% of Full Load ; Vin=Vin(nom)

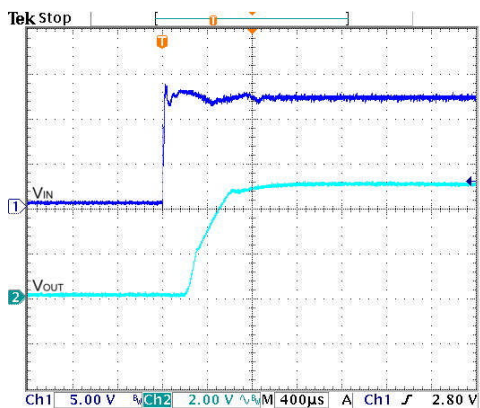

Typical Input Start-Up and Output Rise Characteristic  
Vin=Vin(nom), Full Load

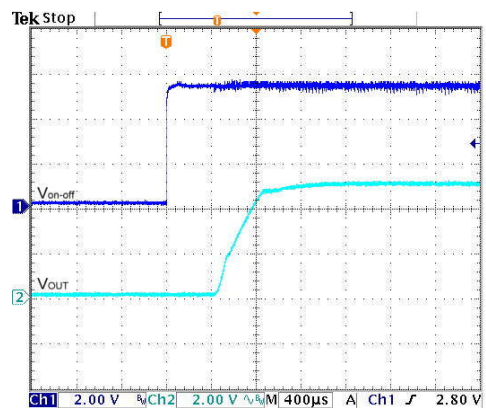

Using ON/OFF Voltage Start-Up and Vo Rise Characteristic  
Vin=Vin(nom), Full Load

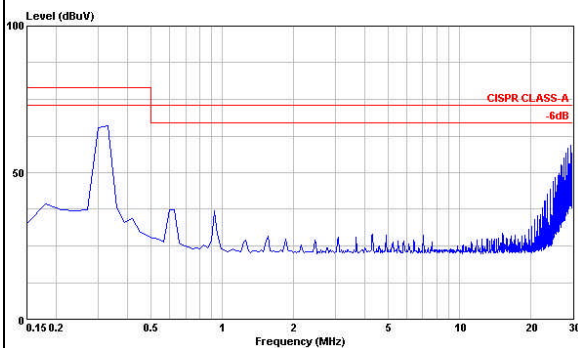

Conduction Emission of EN55022 Class A  
Vin=Vin(nom), Full Load

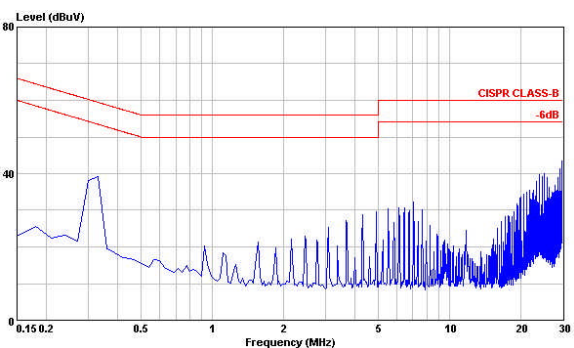

Conduction Emission of EN55022 Class B  
Vin=Vin(nom), Full Load

Characteristic Curves (Continued)

All test conditions are at 25°C. The figures are for PXF40-12T0515

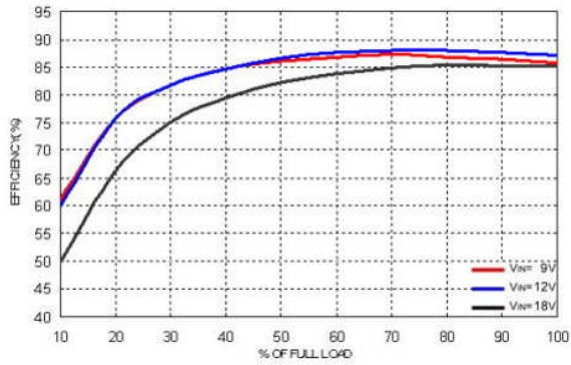

Efficiency Versus Output Current

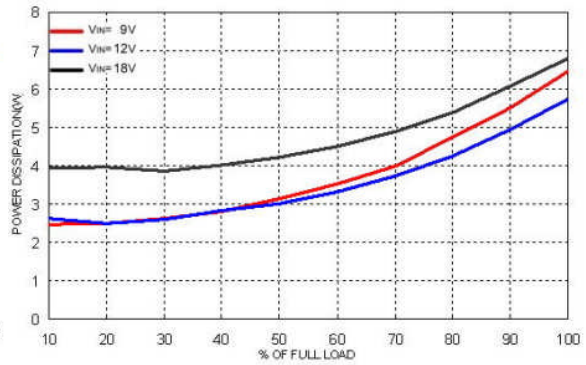

Power Dissipation Versus Output Current

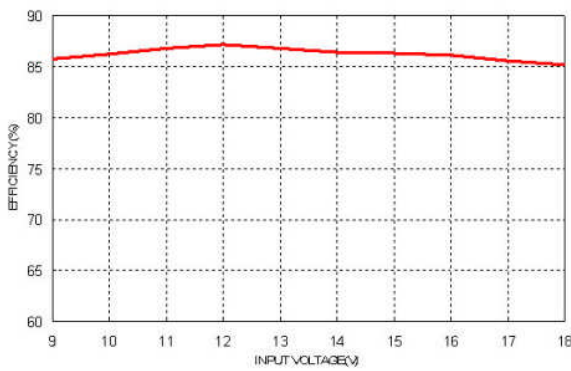

Efficiency Versus Input Voltage. Full Load

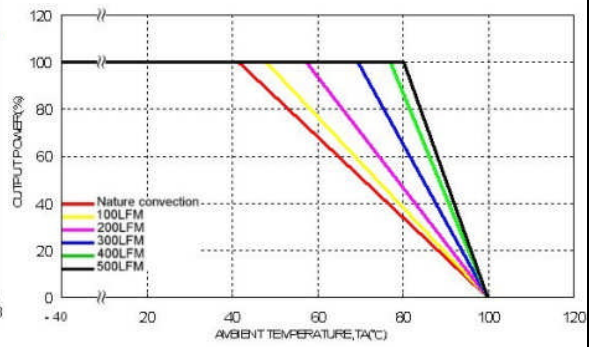

Derating Output Current Versus Ambient Temperature and Airflow Vin=Vin(nom)

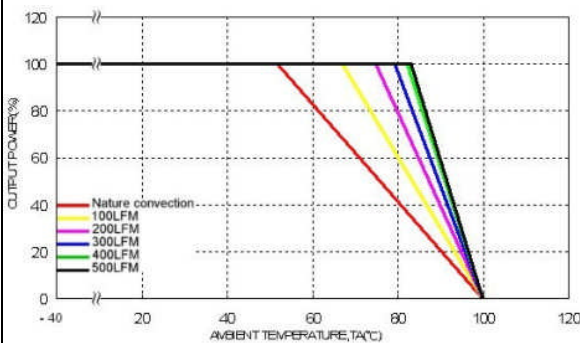

Derating Output Current Versus Ambient Temperature with Heat-Sink and Airflow, Vin = Vin(nom)

Characteristic Curves (Continued)

All test conditions are at 25°C. The figures are for PXF40-12T0515

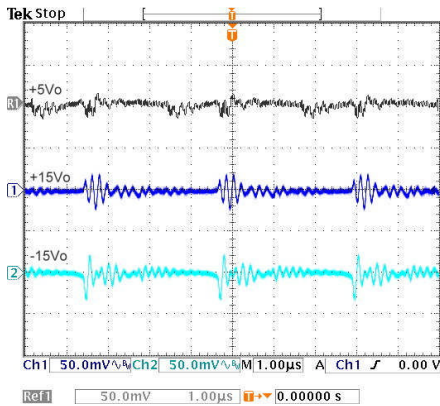

Typical Output Ripple and Noise.  
Vin=Vin(nom), Full Load

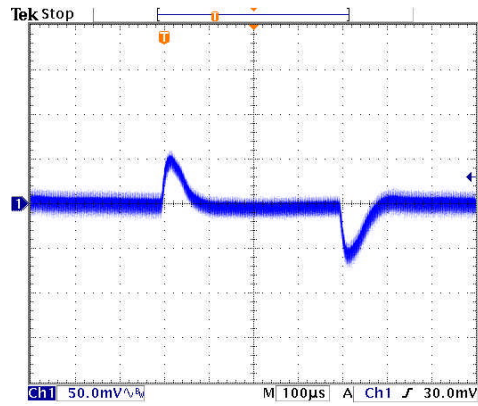

Transient Response to Dynamic Load Change from  
100% to 75% to 100% of Full Load ; Vin=Vin(nom)

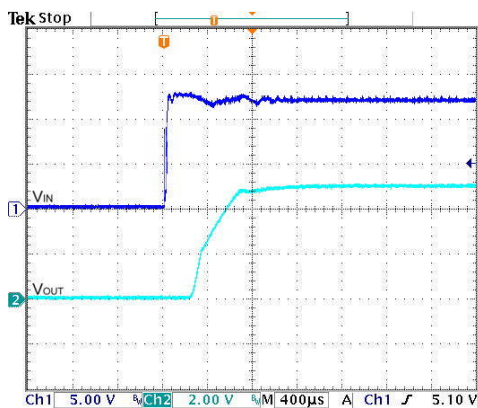

Typical Input Start-Up and Output Rise Characteristic  
Vin=Vin(nom), Full Load

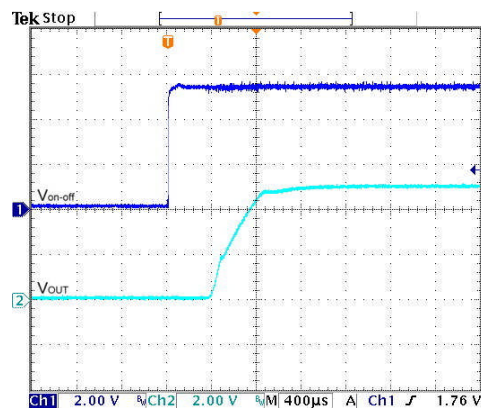

Using ON/OFF Voltage Start-Up and Vo Rise Characteristic  
Vin=Vin(nom), Full Load

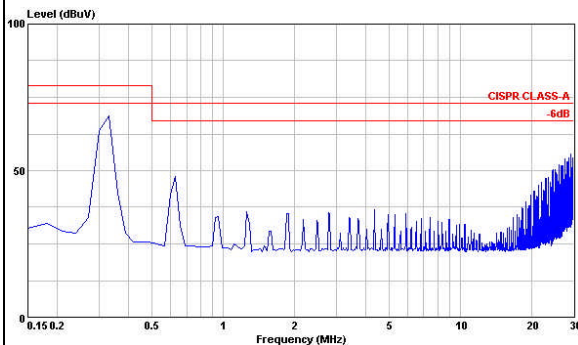

Conduction Emission of EN55022 Class A  
Vin=Vin(nom), Full Load

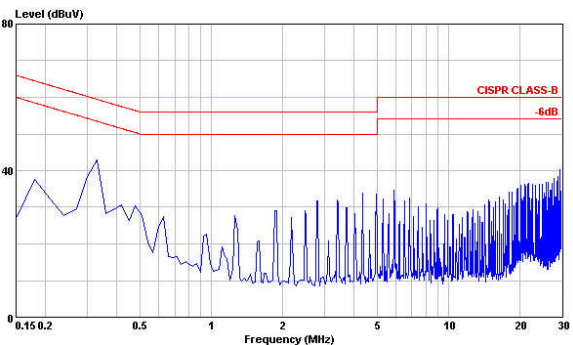

Conduction Emission of EN55022 Class B  
Vin=Vin(nom), Full Load

Characteristic Curves (Continued)

All test conditions are at 25°C. The figures are for PXF40-24T3312

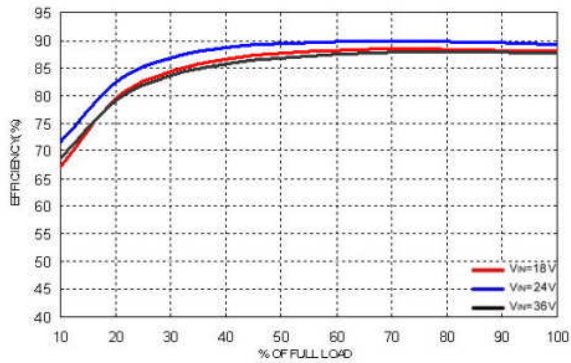

Efficiency Versus Output Current

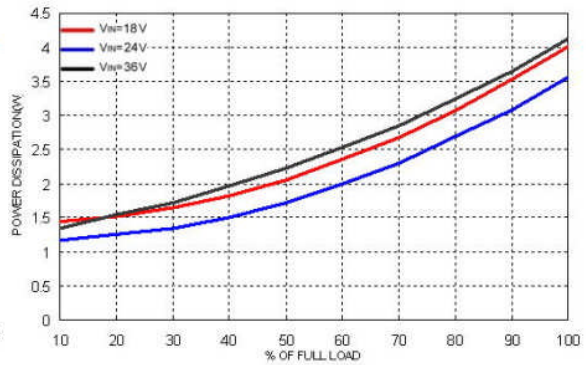

Power Dissipation Versus Output Current

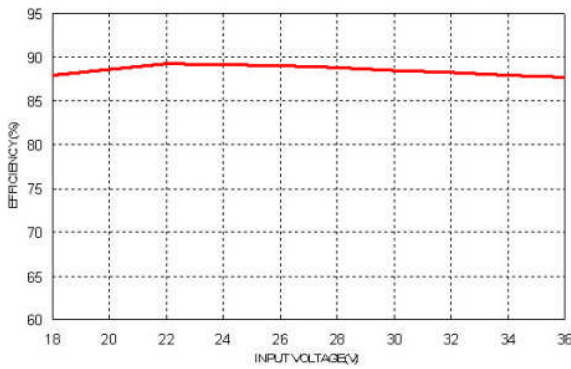

Efficiency Versus Input Voltage. Full Load

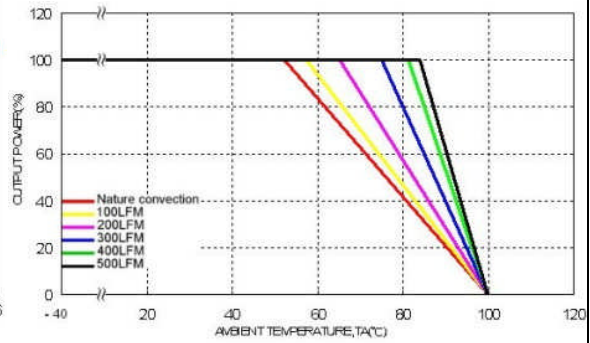

Derating Output Current Versus Ambient Temperature and Airflow Vin=Vin(nom)

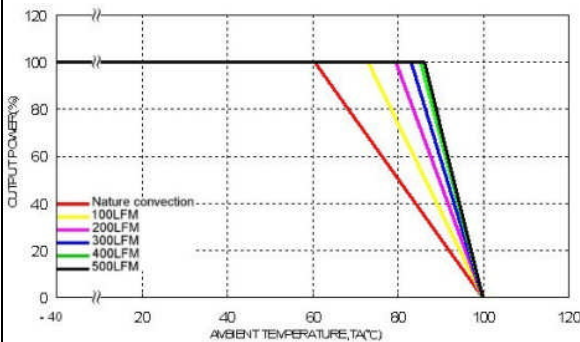

Derating Output Current Versus Ambient Temperature with Heat-Sink and Airflow, Vin = Vin(nom)

Characteristic Curves (Continued)

All test conditions are at 25°C. The figures are for PXF40-24T3312

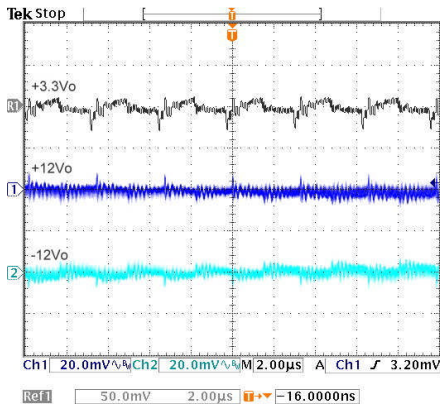

Typical Output Ripple and Noise.  
Vin=Vin(nom), Full Load

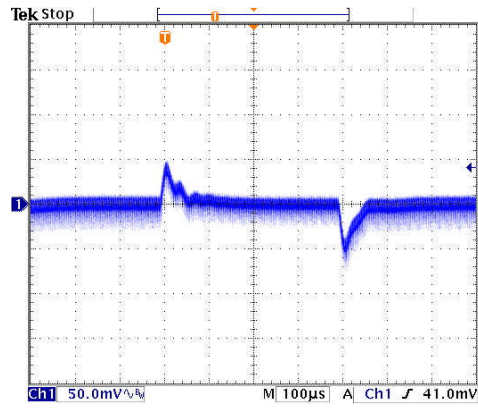

Transient Response to Dynamic Load Change from  
100% to 75% to 100% of Full Load ; Vin=Vin(nom)

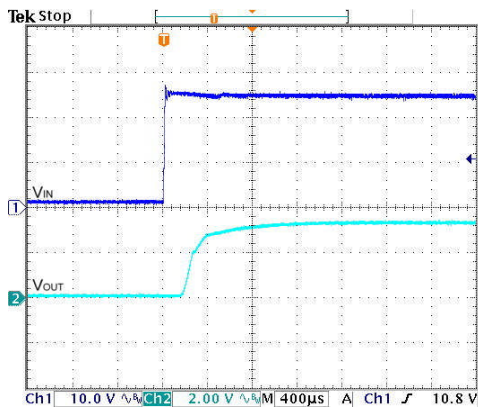

Typical Input Start-Up and Output Rise Characteristic  
Vin=Vin(nom), Full Load

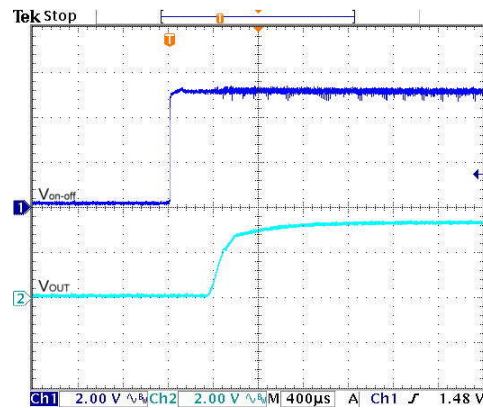

Using ON/OFF Voltage Start-Up and Vo Rise Characteristic  
Vin=Vin(nom), Full Load

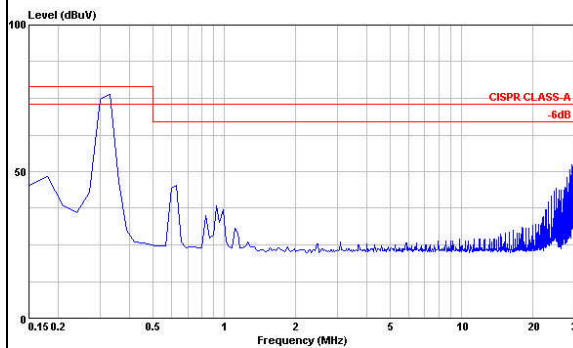

Conduction Emission of EN55022 Class A  
Vin=Vin(nom), Full Load

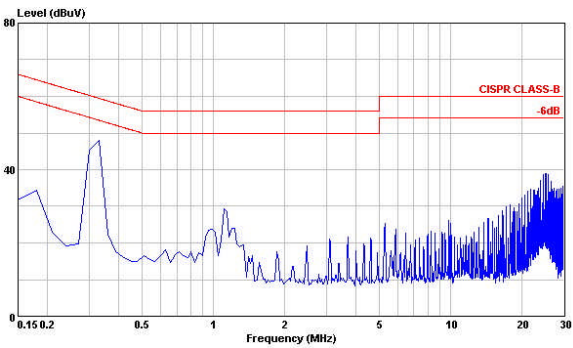

Conduction Emission of EN55022 Class B  
Vin=Vin(nom), Full Load

Characteristic Curves (Continued)

All test conditions are at 25°C. The figures are for PXF40-24T3315

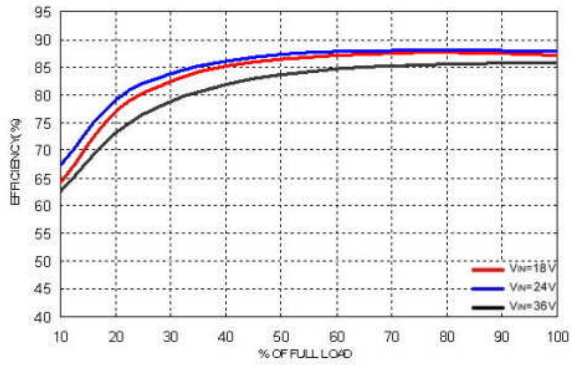

Efficiency Versus Output Current

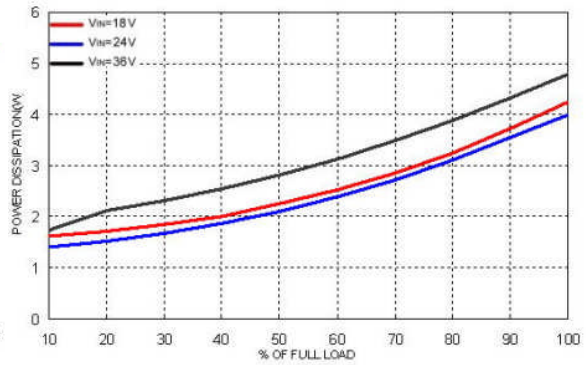

Power Dissipation Versus Output Current

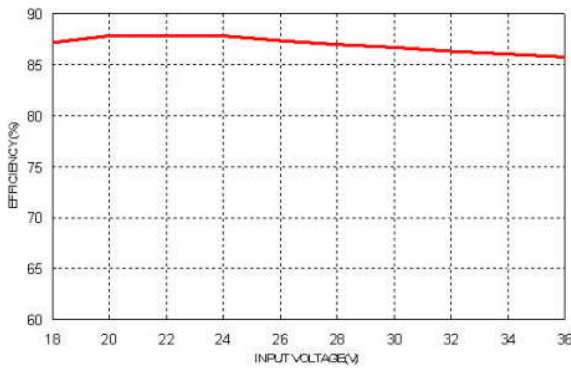

Efficiency Versus Input Voltage. Full Load

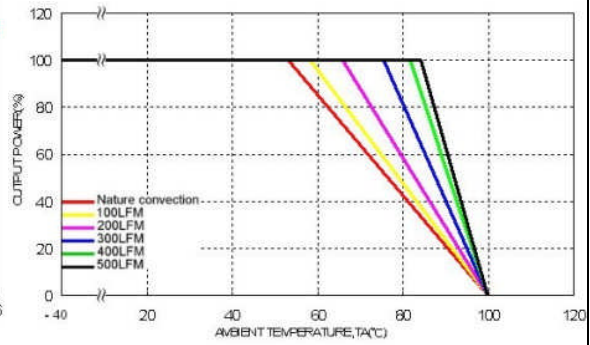

Derating Output Current Versus Ambient Temperature and Airflow Vin=Vin(nom)

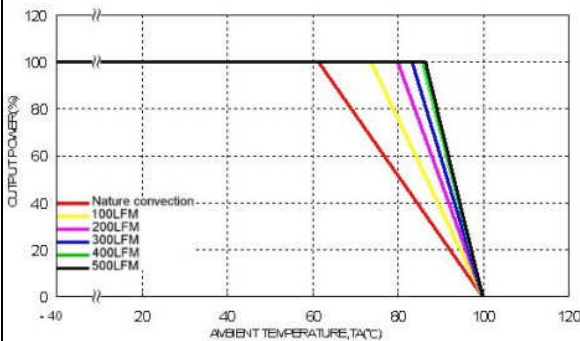

Derating Output Current Versus Ambient Temperature with Heat-Sink and Airflow, Vin = Vin(nom)

Characteristic Curves (Continued)

All test conditions are at 25°C. The figures are for PXF24T3315

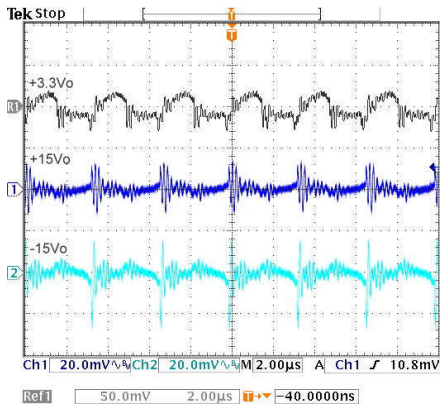

Typical Output Ripple and Noise.  
Vin=Vin(nom), Full Load

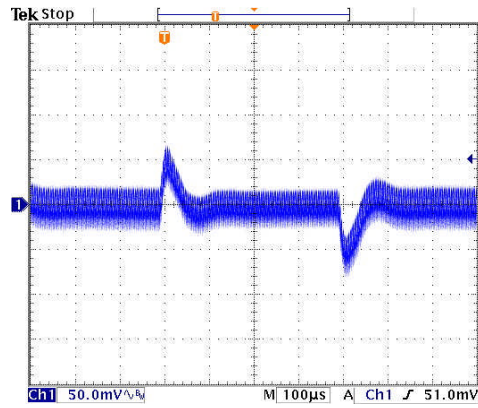

Transient Response to Dynamic Load Change from  
100% to 75% to 100% of Full Load ; Vin=Vin(nom)

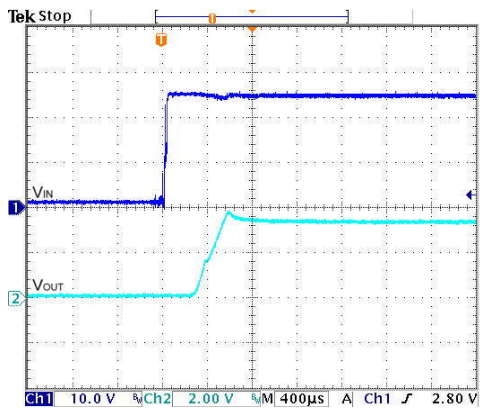

Typical Input Start-Up and Output Rise Characteristic  
Vin=Vin(nom), Full Load

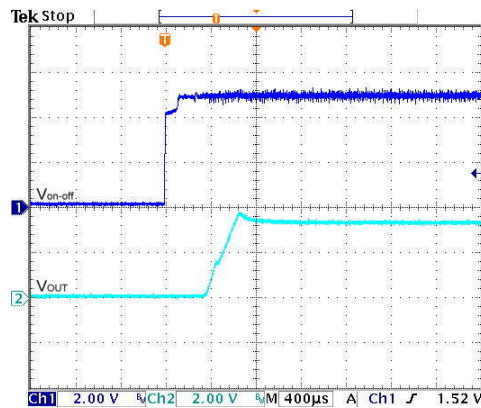

Using ON/OFF Voltage Start-Up and Vo Rise Characteristic  
Vin=Vin(nom), Full Load

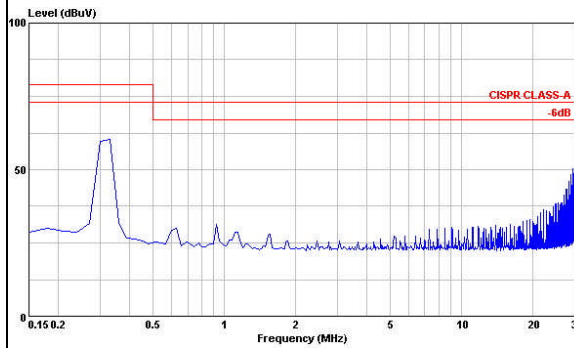

Conduction Emission of EN55022 Class A  
Vin=Vin(nom), Full Load

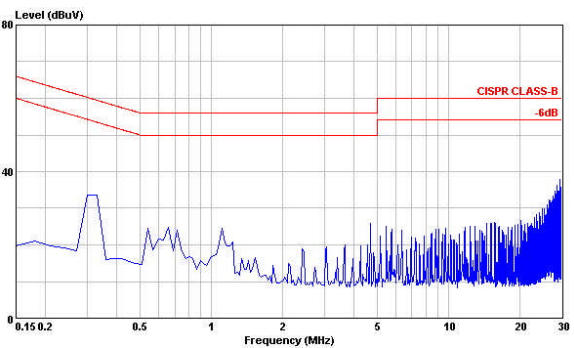

Conduction Emission of EN55022 Class B  
Vin=Vin(nom), Full Load



Characteristic Curves (Continued)

All test conditions are at 25°C. The figures are for PXF24T0512

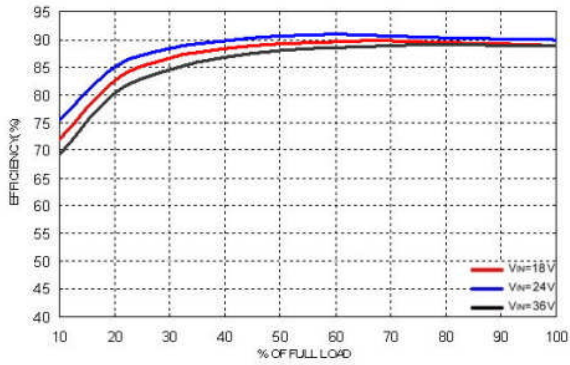

Efficiency Versus Output Current

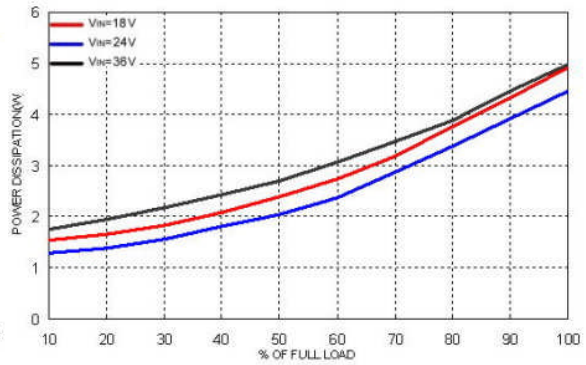

Power Dissipation Versus Output Current

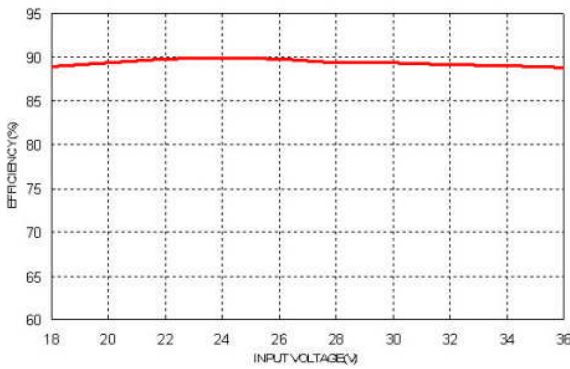

Efficiency Versus Input Voltage. Full Load

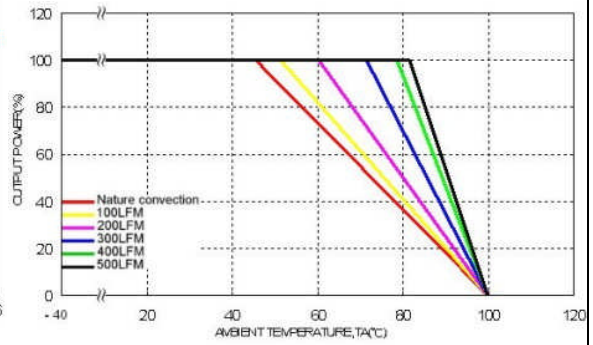

Derating Output Current Versus Ambient Temperature and Airflow Vin=Vin(nom)

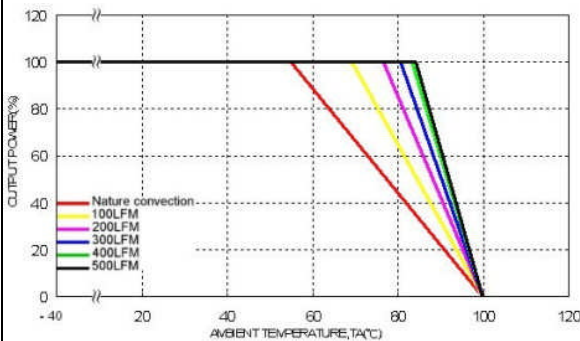

Derating Output Current Versus Ambient Temperature with Heat-Sink and Airflow, Vin = Vin(nom)

Characteristic Curves (Continued)

All test conditions are at 25°C. The figures are for PXF40-24T0512

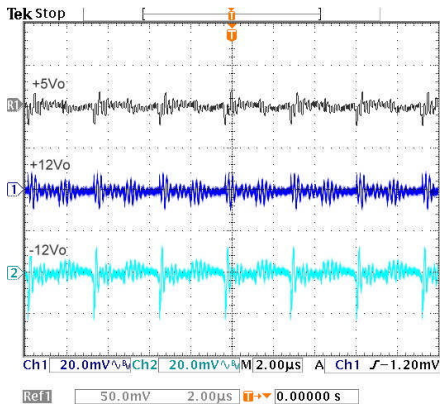

Typical Output Ripple and Noise.  
Vin=Vin(nom), Full Load

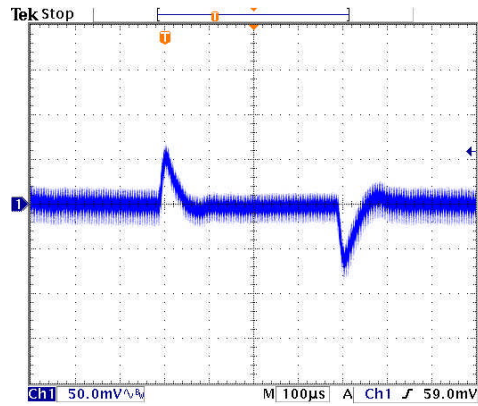

Transient Response to Dynamic Load Change from  
100% to 75% to 100% of Full Load ; Vin=Vin(nom)

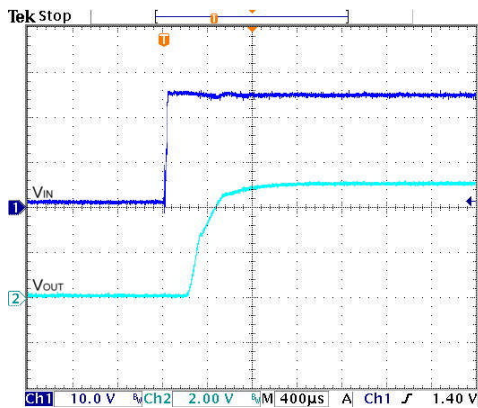

Typical Input Start-Up and Output Rise Characteristic  
Vin=Vin(nom), Full Load

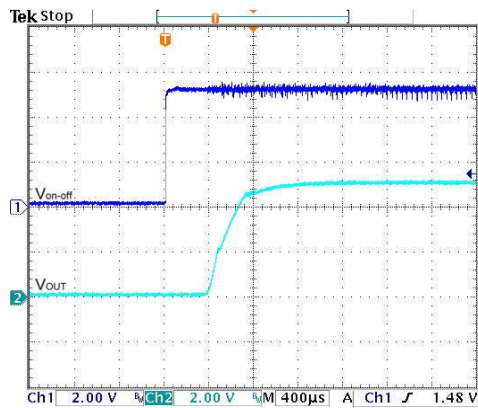

Using ON/OFF Voltage Start-Up and Vo Rise Characteristic  
Vin=Vin(nom), Full Load

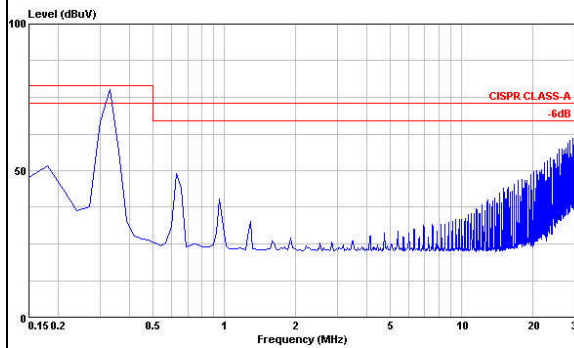

Conduction Emission of EN55022 Class A  
Vin=Vin(nom), Full Load

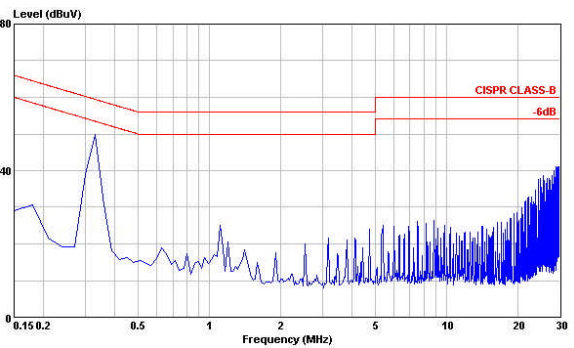

Conduction Emission of EN55022 Class B  
Vin=Vin(nom), Full Load

Characteristic Curves (Continued)

All test conditions are at 25°C. The figures are for PXF40-24T0515

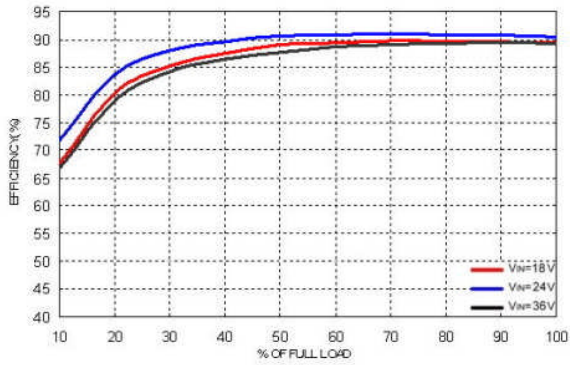

Efficiency Versus Output Current

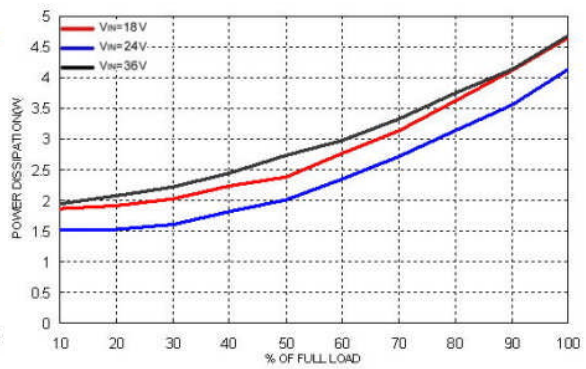

Power Dissipation Versus Output Current

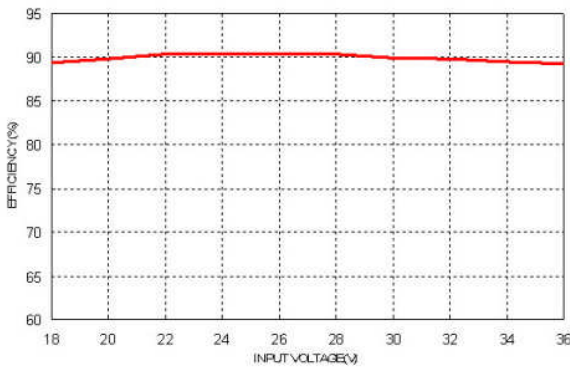

Efficiency Versus Input Voltage. Full Load

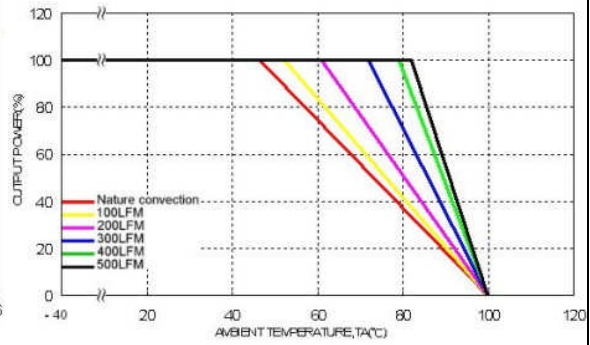

Derating Output Current Versus Ambient Temperature and Airflow Vin=Vin(nom)

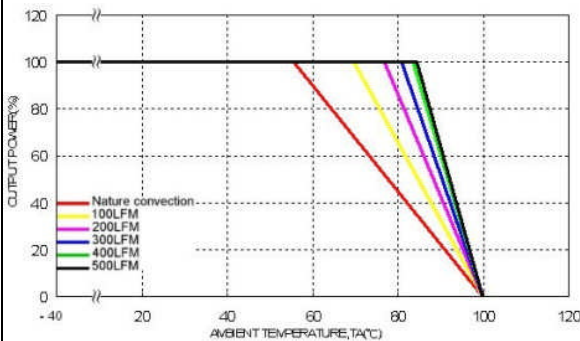

Derating Output Current Versus Ambient Temperature with Heat-Sink and Airflow, Vin = Vin(nom)

Characteristic Curves (Continued)

All test conditions are at 25°C. The figures are for PXF40-24T0515

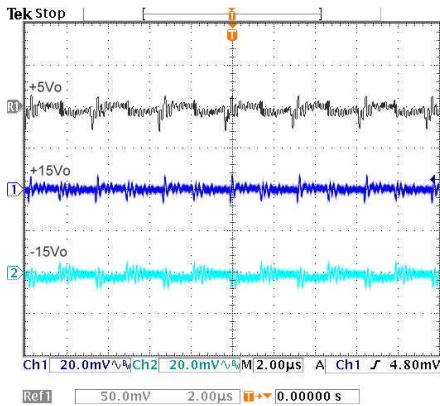

Typical Output Ripple and Noise.  
Vin=Vin(nom), Full Load

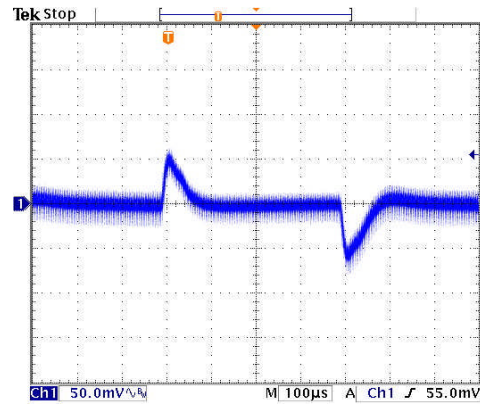

Transient Response to Dynamic Load Change from  
100% to 75% to 100% of Full Load ; Vin=Vin(nom)

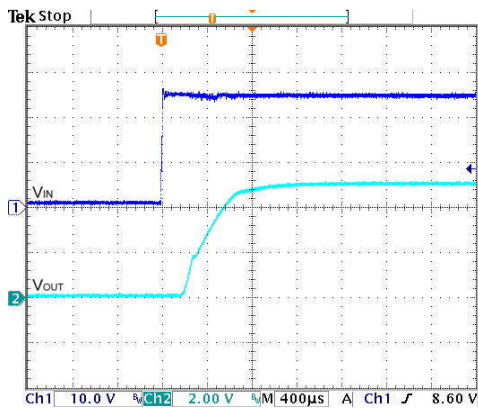

Typical Input Start-Up and Output Rise Characteristic  
Vin=Vin(nom), Full Load

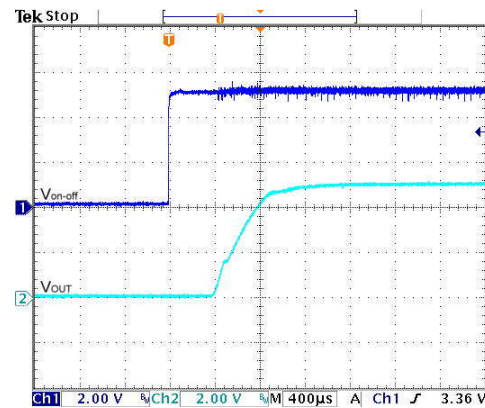

Using ON/OFF Voltage Start-Up and Vo Rise Characteristic  
Vin=Vin(nom), Full Load

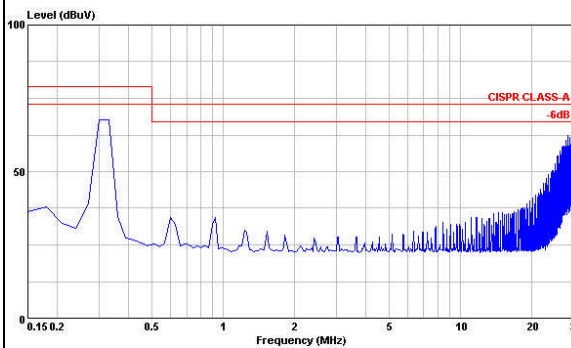

Conduction Emission of EN55022 Class A  
Vin=Vin(nom), Full Load

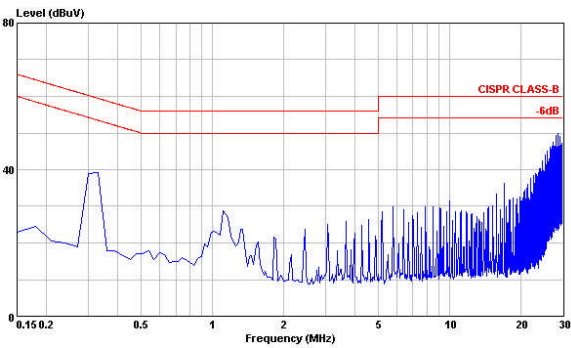

Conduction Emission of EN55022 Class B  
Vin=Vin(nom), Full Load

Characteristic Curves (Continued)

All test conditions are at 25°C. The figures are for PXF48T3312

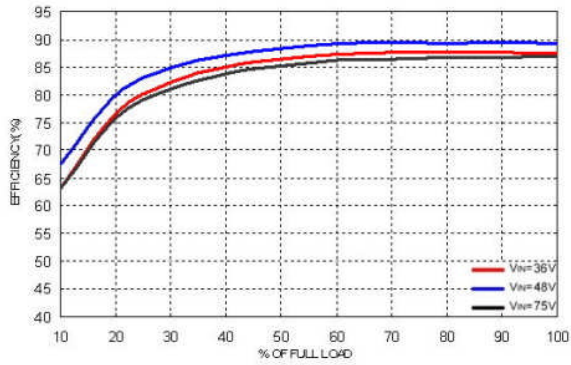

Efficiency Versus Output Current

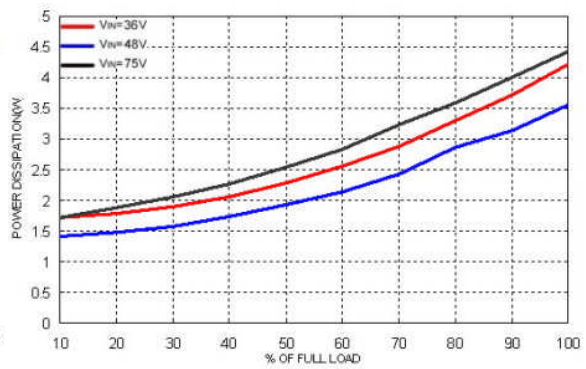

Power Dissipation Versus Output Current

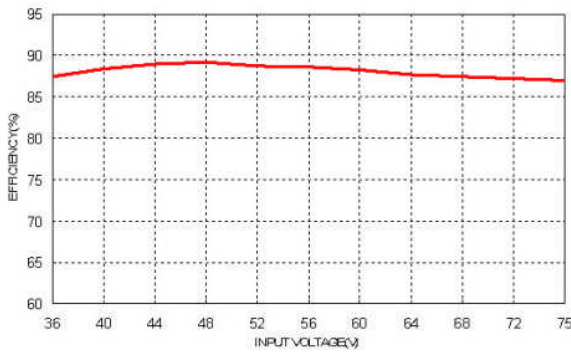

Efficiency Versus Input Voltage. Full Load

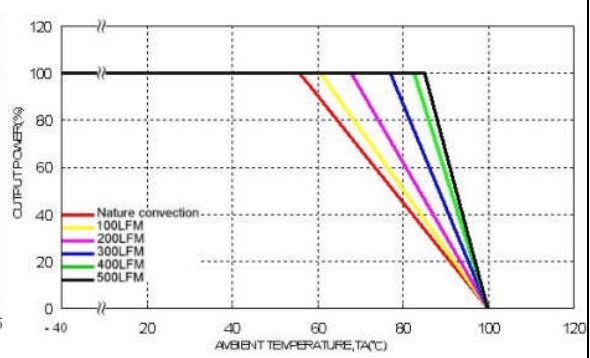

Derating Output Current Versus Ambient Temperature and Airflow Vin=Vin(nom)

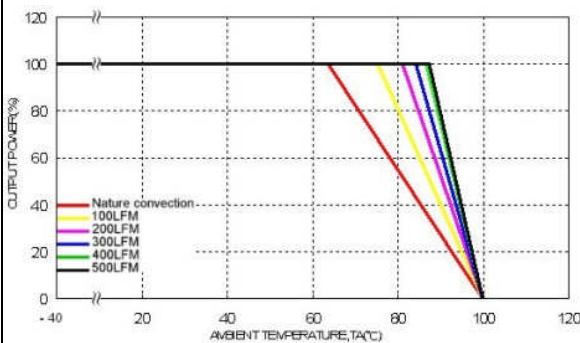

Derating Output Current Versus Ambient Temperature with Heat-Sink and Airflow, Vin = Vin(nom)

Characteristic Curves (Continued)

All test conditions are at 25°C. The figures are for PXF40-48T3312

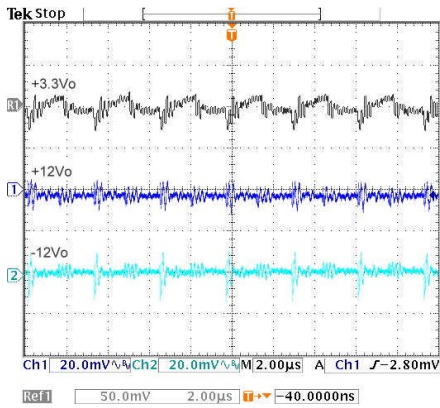

Typical Output Ripple and Noise.  
Vin=Vin(nom), Full Load

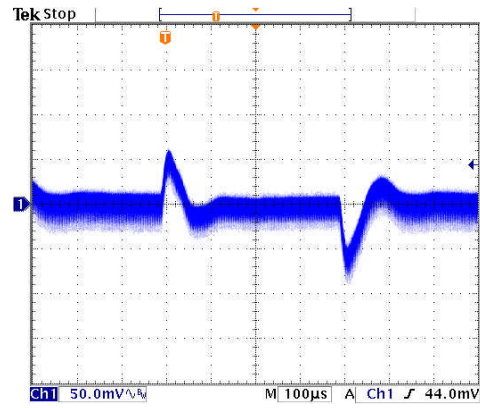

Transient Response to Dynamic Load Change from  
100% to 75% to 100% of Full Load ; Vin=Vin(nom)

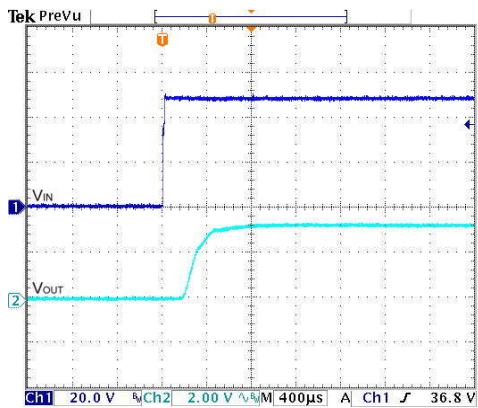

Typical Input Start-Up and Output Rise Characteristic  
Vin=Vin(nom), Full Load

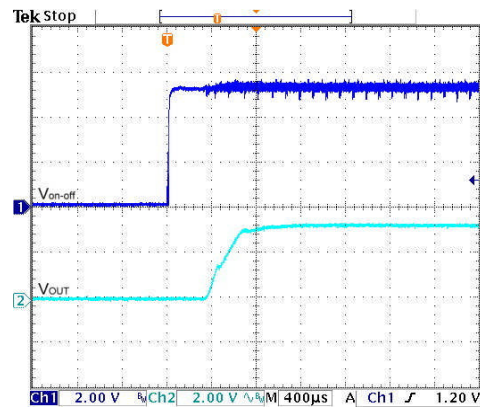

Using ON/OFF Voltage Start-Up and Vo Rise Characteristic  
Vin=Vin(nom), Full Load

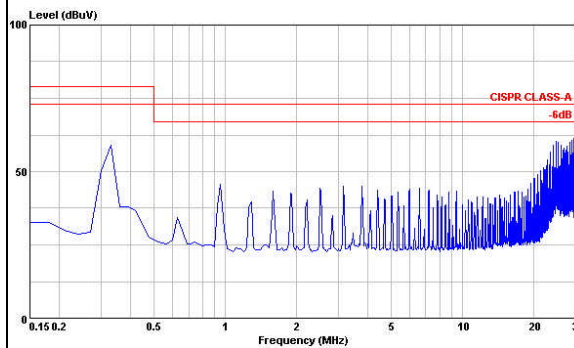

Conduction Emission of EN55022 Class A  
Vin=Vin(nom), Full Load

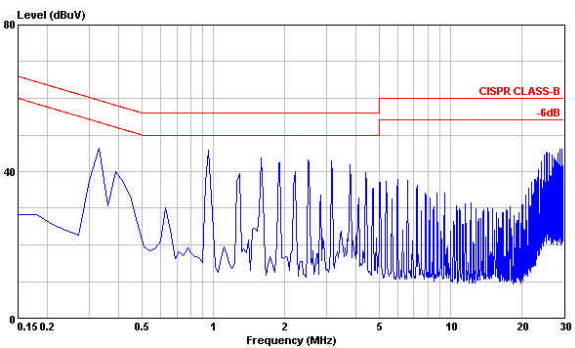

Conduction Emission of EN55022 Class B  
Vin=Vin(nom), Full Load

Characteristic Curves (Continued)

All test conditions are at 25°C. The figures are for PXF40-48T3315

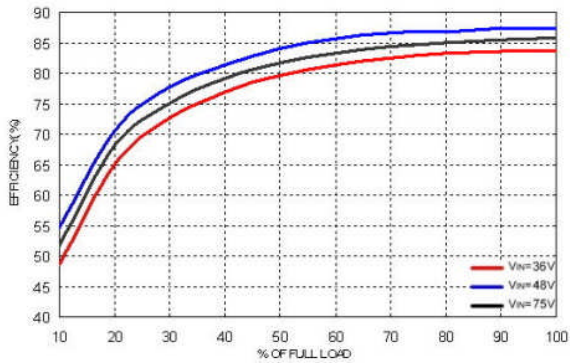

Efficiency Versus Output Current

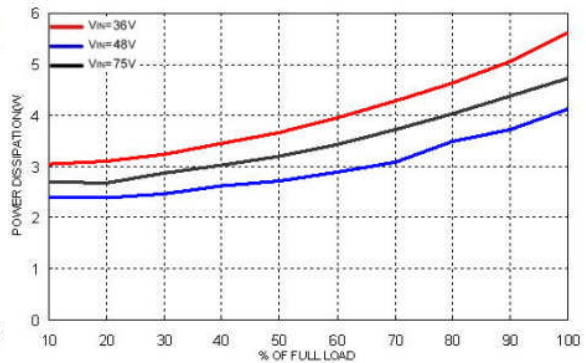

Power Dissipation Versus Output Current

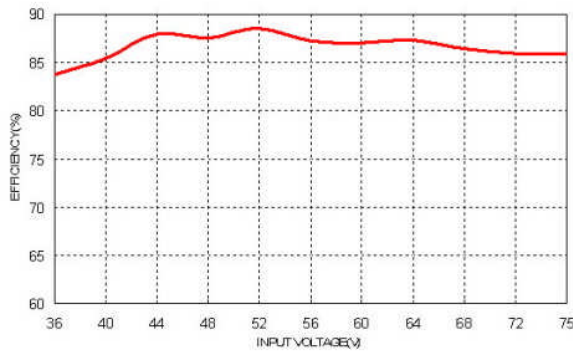

Efficiency Versus Input Voltage. Full Load

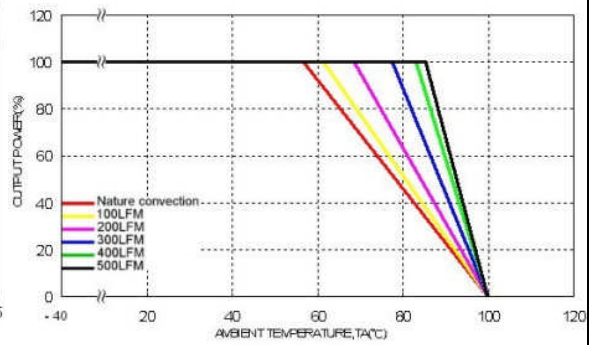

Derating Output Current Versus Ambient Temperature and Airflow Vin=Vin(nom)

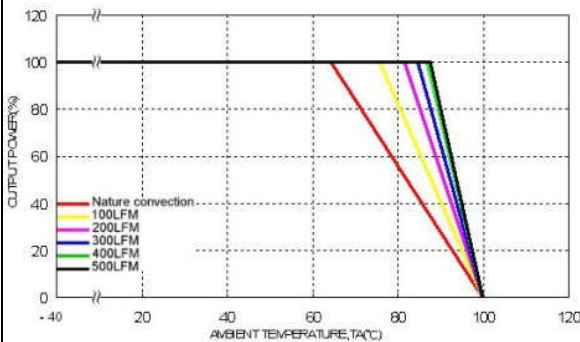

Derating Output Current Versus Ambient Temperature with Heat-Sink and Airflow, Vin = Vin(nom)

Characteristic Curves (Continued)

All test conditions are at 25°C. The figures are for PXF40-48T3315

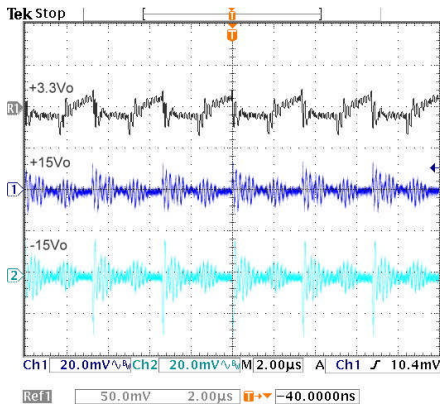

Typical Output Ripple and Noise.  
Vin=Vin(nom), Full Load

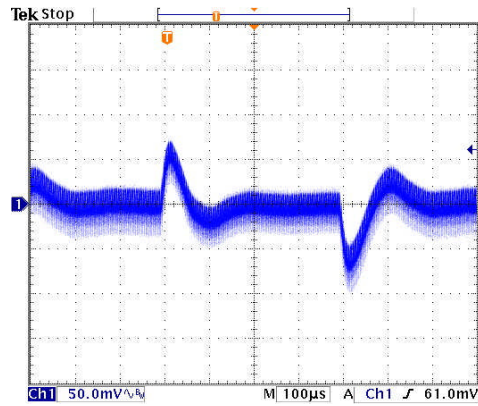

Transient Response to Dynamic Load Change from 100% to 75% to 100% of Full Load ; Vin=Vin(nom)

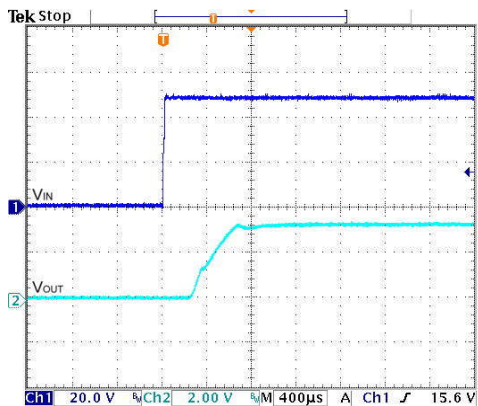

Typical Input Start-Up and Output Rise Characteristic  
Vin=Vin(nom), Full Load

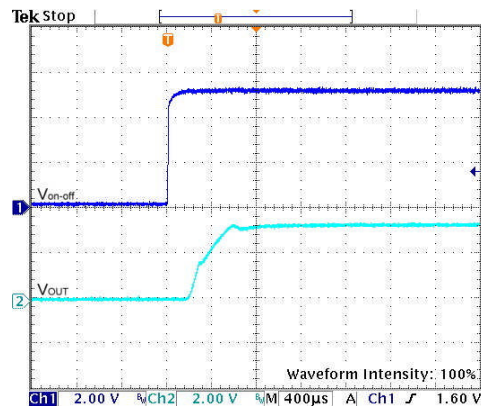

Using ON/OFF Voltage Start-Up and Vo Rise Characteristic  
Vin=Vin(nom), Full Load

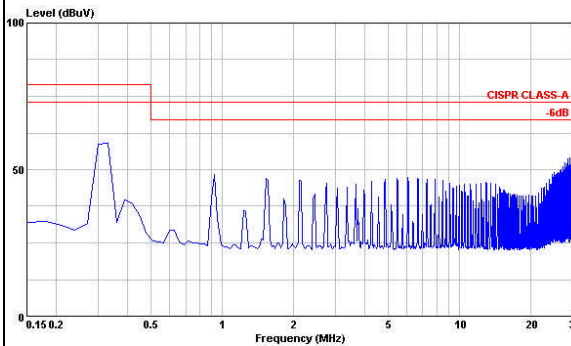

Conduction Emission of EN55022 Class A  
Vin=Vin(nom), Full Load

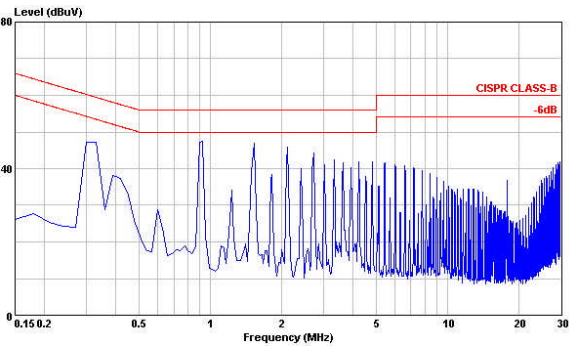

Conduction Emission of EN55022 Class B  
Vin=Vin(nom), Full Load



Characteristic Curves (Continued)

All test conditions are at 25°C. The figures are for PXF40-48T0512

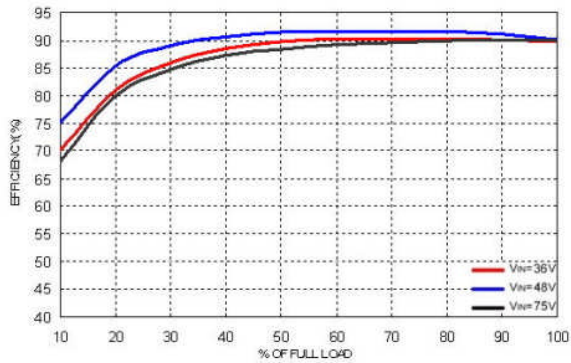

Efficiency Versus Output Current

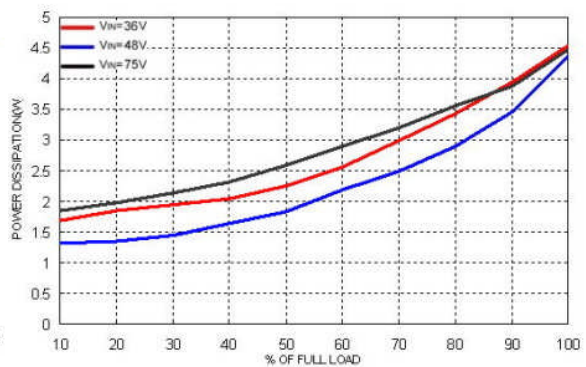

Power Dissipation Versus Output Current

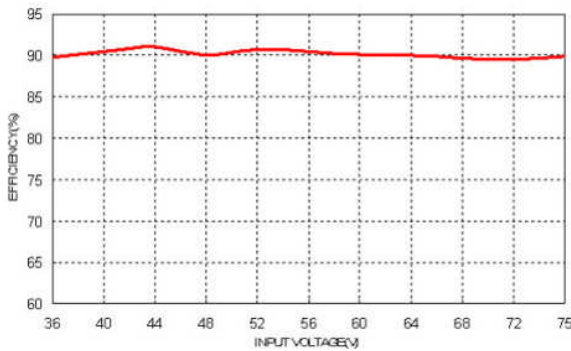

Efficiency Versus Input Voltage. Full Load

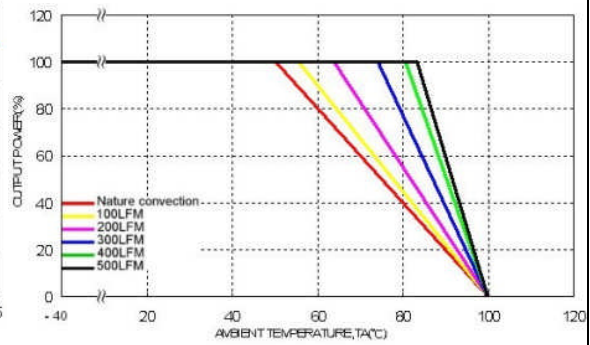

Derating Output Current Versus Ambient Temperature and Airflow Vin=Vin(nom)

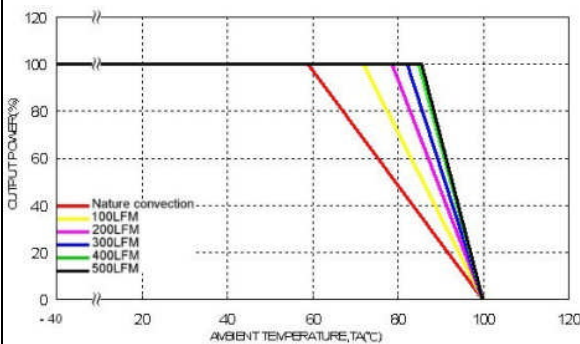

Derating Output Current Versus Ambient Temperature with Heat-Sink and Airflow, Vin = Vin(nom)

Characteristic Curves (Continued)

All test conditions are at 25°C. The figures are for PXF40-48T0512

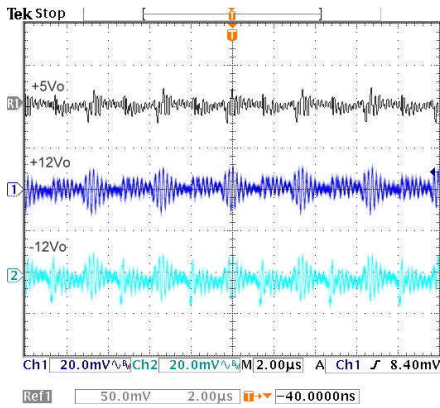

Typical Output Ripple and Noise.  
Vin=Vin(nom), Full Load

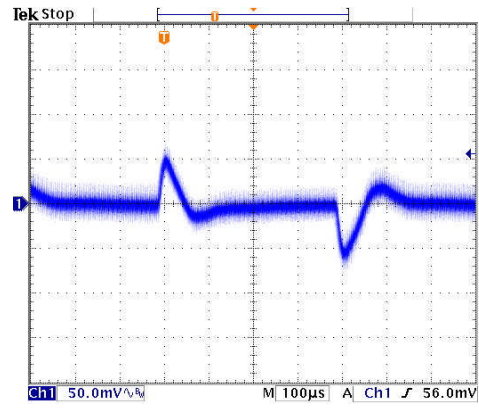

Transient Response to Dynamic Load Change from 100% to 75% to 100% of Full Load ; Vin=Vin(nom)

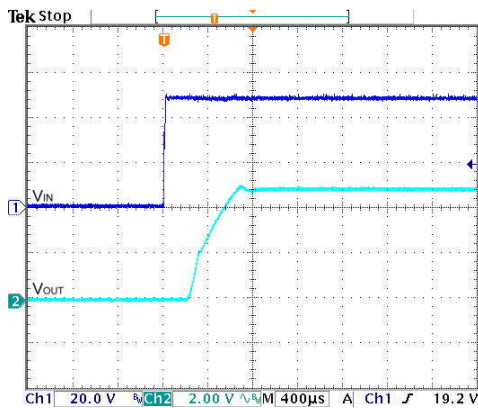

Typical Input Start-Up and Output Rise Characteristic  
Vin=Vin(nom), Full Load

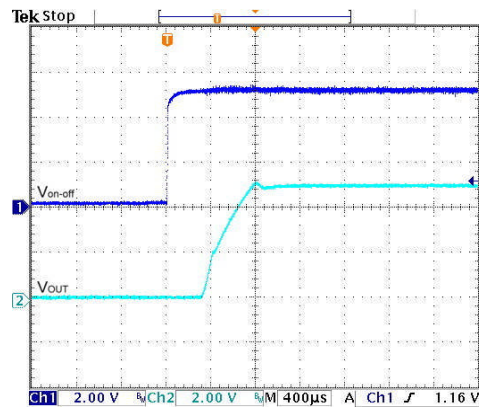

Using ON/OFF Voltage Start-Up and Vo Rise Characteristic  
Vin=Vin(nom), Full Load

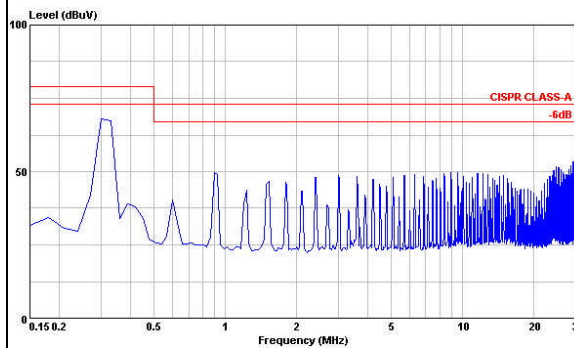

Conduction Emission of EN55022 Class A  
Vin=Vin(nom), Full Load

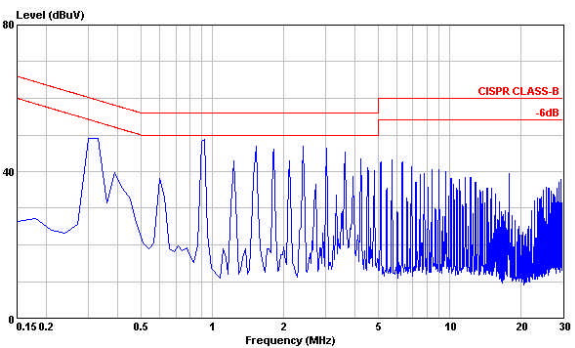

Conduction Emission of EN55022 Class B  
Vin=Vin(nom), Full Load

Characteristic Curves (Continued)

All test conditions are at 25°C. The figures are for PXF40-48T0515

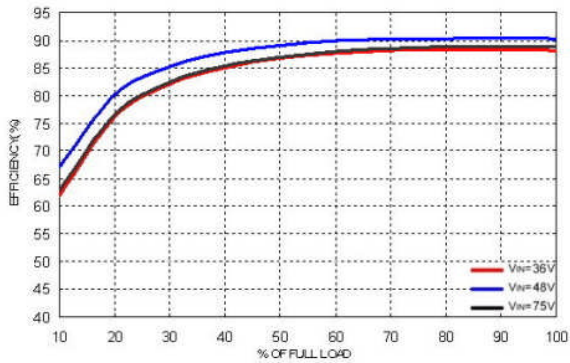

Efficiency Versus Output Current

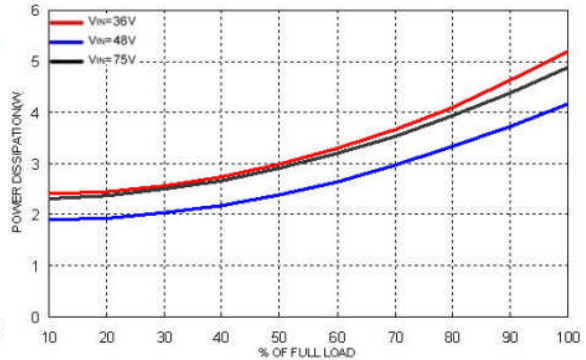

Power Dissipation Versus Output Current

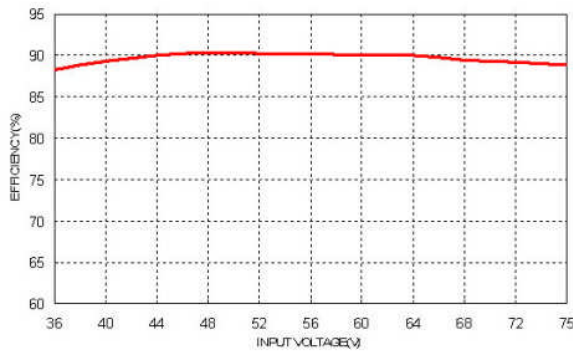

Efficiency Versus Input Voltage. Full Load

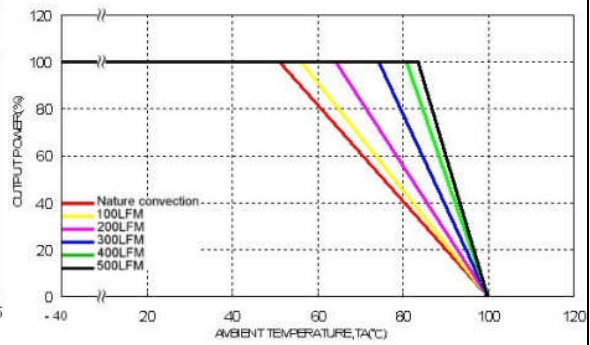

Derating Output Current Versus Ambient Temperature and Airflow Vin=Vin(nom)

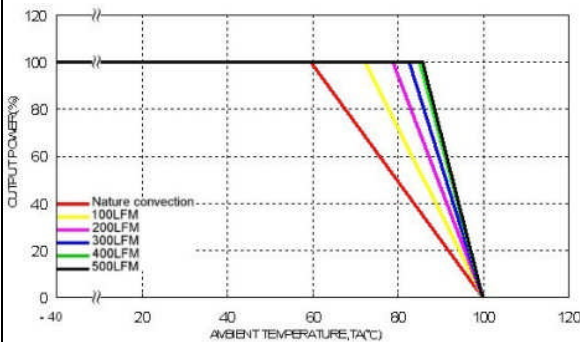

Derating Output Current Versus Ambient Temperature with Heat-Sink and Airflow, Vin = Vin(nom)

Characteristic Curves (Continued)

All test conditions are at 25°C. The figures are for PXF40-48T0515

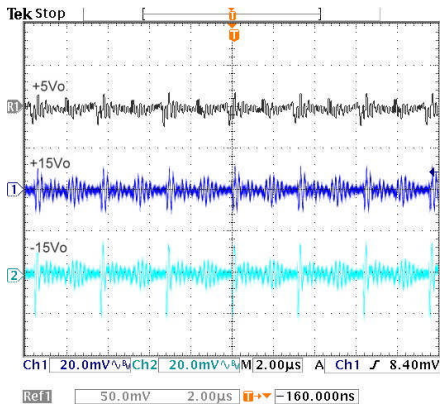

Typical Output Ripple and Noise.  
Vin=Vin(nom), Full Load

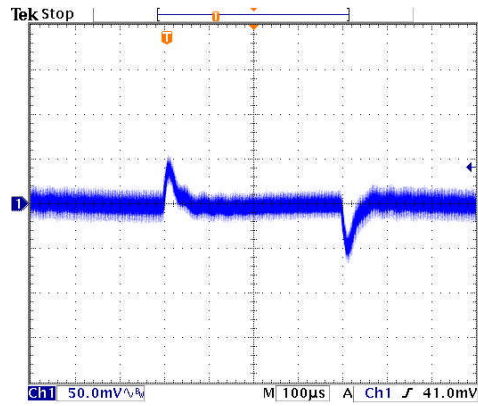

Transient Response to Dynamic Load Change from 100% to 75% to 100% of Full Load ; Vin=Vin(nom)

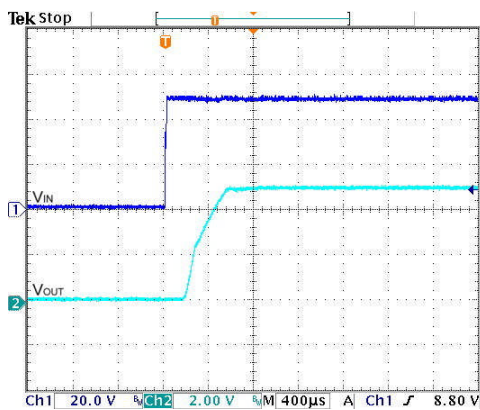

Typical Input Start-Up and Output Rise Characteristic  
Vin=Vin(nom), Full Load

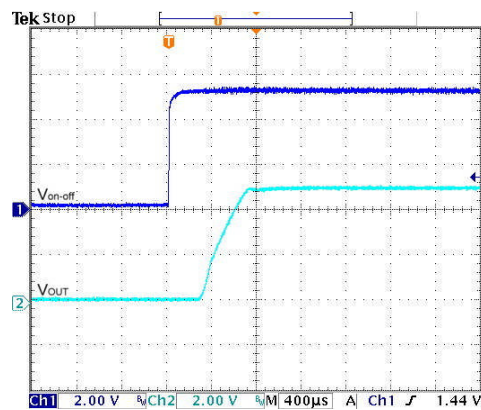

Using ON/OFF Voltage Start-Up and Vo Rise Characteristic  
Vin=Vin(nom), Full Load

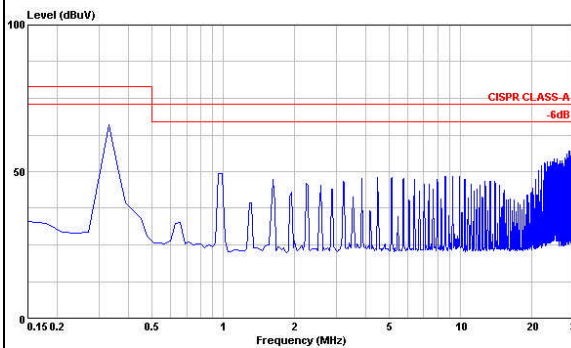

Conduction Emission of EN55022 Class A  
Vin=Vin(nom), Full Load

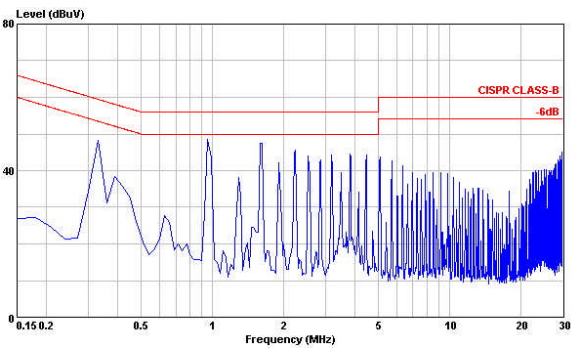

Conduction Emission of EN55022 Class B  
Vin=Vin(nom), Full Load

Test Configurations

Input reflected-ripple current measurement test:

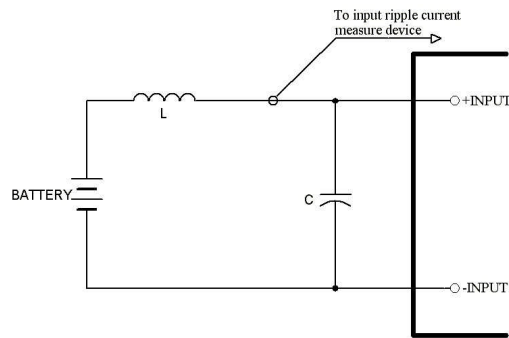

Component	Value	Voltage	Reference
L	12μH	—	—
C	220μF	100V	Aluminum Electrolytic Capacitor

Peak-to-peak output ripple & noise measurement test:

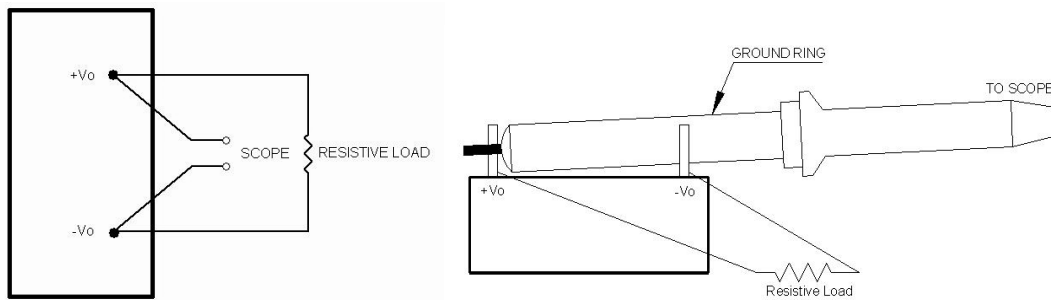

Output voltage and efficiency measurement test:

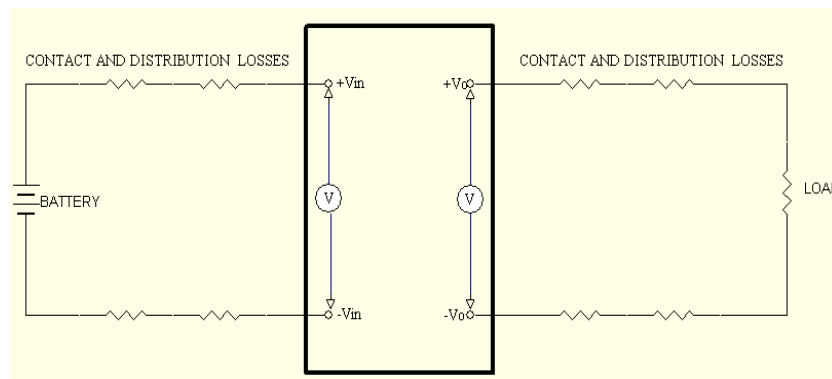

Note: All measurements are taken at the module terminals.

$$Efficiency = \left( \frac{V_o \times I_o}{V_{in} \times I_{in}} \right) \times 100\%$$

EMC Considerations

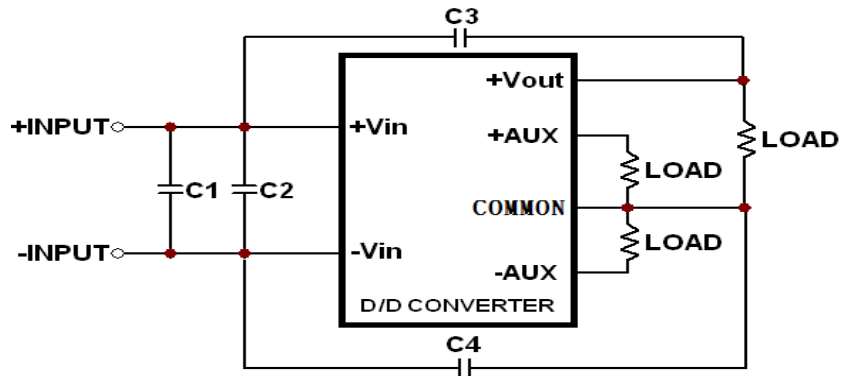

Suggested Schematic for EN55022 Conducted Emission Class A Limits

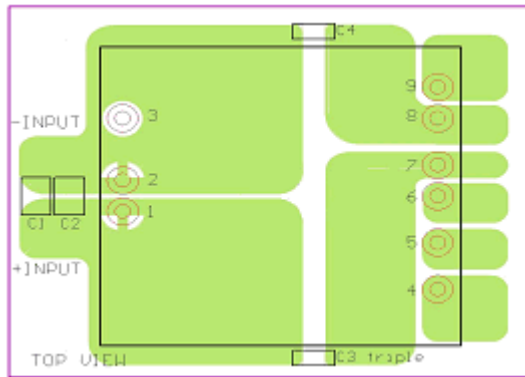

Recommended Layout with Input Filter

To meet conducted emissions EN55022 CLASS A needed the following components :

PXF40-12Txxxx

Component	Value	Voltage	Reference
C1	6.8uF	50V	1812 MLCC
C3 - C4	1000pF	2KV	1808 MLCC

PXF40-24Txxxx

Component	Value	Voltage	Reference
C1	6.8uF	50V	1812 MLCC
C3 - C4	1000pF	2KV	1808 MLCC

PXF40-48Txxxx

Component	Value	Voltage	Reference
C1	2.2uF	100V	1812 MLCC
C3 - C4	1000pF	2KV	1808 MLCC

EMC Considerations (Continued)

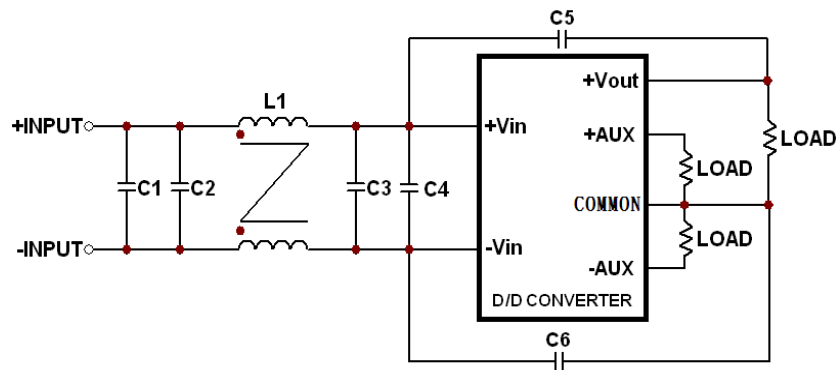

Suggested Schematic for EN55022 Conducted Emission Class B Limits

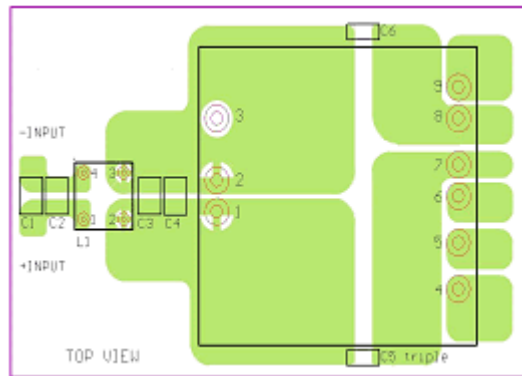

Recommended Layout with Input Filter

To meet conducted emissions EN55022 CLASS B needed the following components :

PXF40-12Txxxx

Component	Value	Voltage	Reference
C1 、 C3	4.7uF	50V	1812 MLCC
C5 、 C6	1000pF	2KV	1808 MLCC
L1	450uH	----	Common Choke

PXF40-24Txxxx

Component	Value	Voltage	Reference
C1 、 C3	6.8uF	50V	1812 MLCC
C5 、 C6	1000pF	2KV	1808 MLCC
L1	450uH	----	Common Choke

PXF40-48Txxxx

Component	Value	Voltage	Reference
C1 、 C2	2.2uF	100V	1812 MLCC
C3 、 C4	2.2uF	100V	1812 MLCC
C5 、 C6	1000pF	2KV	1808 MLCC
L1	830uH	----	Common Choke`





## EMC Considerations (Continued)

This Common Choke L1 has been define as follows:

- L1 :  $450\mu\text{H}\pm 35\%$  / DCR :  $25\text{m}\Omega$ , max  
A height : 9.8 mm, Max
- L1 :  $830\mu\text{H}\pm 35\%$  / DCR :  $31\text{m}\Omega$ , max  
A height : 8.8 mm, Max
- Test condition : 100KHz / 100mV
- Recommended through hole :  $\Phi 0.8\text{mm}$
- All dimensions in millimeters

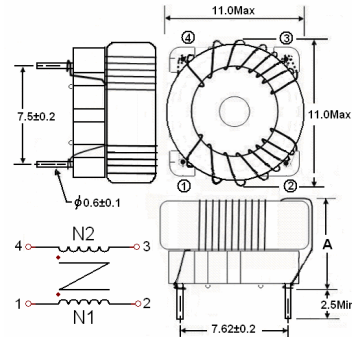

## Input Source Impedance

The power module should be connected to a low impedance input source. Highly inductive source impedance can affect the stability of the power module. Input external L-C filter is recommended to minimize input reflected ripple current. The inductor has a source impedance of  $12\mu\text{H}$  and capacitor is Nippon chemi-con KY series  $220\mu\text{F}/100\text{V}$ . The capacitor must be located as close as possible to the input terminals of the power module for lowest impedance.

## Output Over Current Protection

When excessive output currents occur in the system, circuit protection is required on all power supplies. Normally, overload current is maintained at approximately 150 percent of rated current for PXF40-xxTxxxx series.

Hiccup-mode is a method of operation in a converter whose purpose is to protect the power supply from being damaged during an over-current fault condition. It also enables the converter to restart when the fault is removed. There are other ways of protecting the converter when it is over-loaded, such as the maximum current limiting or current foldback methods.

One of the problems resulting from over current is that excessive heat may be generated in power devices; especially MOSFET and Schottky diodes and the temperature of these devices may exceed their specified limits. A protection mechanism has to be used to prevent these power devices from being damaged.

The operation of hiccup is as follows. When the current sense circuit sees an over-current event, the controller shuts off the converter for a given time and then tries to start up the converter again. If the over-load condition has been removed, the converter will start up and operate normally; otherwise, the controller will see another over-current event and will shut off the converter again, repeating the previous cycle. Hiccup operation has none of the drawbacks of the other two protection methods, although its circuit is more complicated because it requires a timing circuit. The excess heat due to overload lasts for only a short duration in the hiccup cycle, hence the junction temperature of the power devices is much lower.

### Output Over Voltage Protection

The output over-voltage protection consists of an output Zener diode that monitors the voltage on the output terminals. If the voltage on the output terminals exceeds the over-voltage protection threshold, then the Zener diode clamps the output voltage.

### Short Circuit Protection

Continuous, hiccup and auto-recovery mode.

During a short circuit the converter shuts down. The average current during this condition will be very low.

### Thermal Consideration

The converter operates in a variety of thermal environments. However, sufficient cooling should be provided to help ensure reliable operation of the unit. Heat is removed by conduction, convection, and radiation to the surrounding environment. Proper cooling can be verified by measuring the point as shown in the figure below. The temperature at this location should not exceed 100°C. When operating, adequate cooling must be provided to maintain the test point temperature at or below 100°C. Although the maximum point temperature of the power module is 100°C, limiting this temperature to a lower value will increase the reliability of the unit.

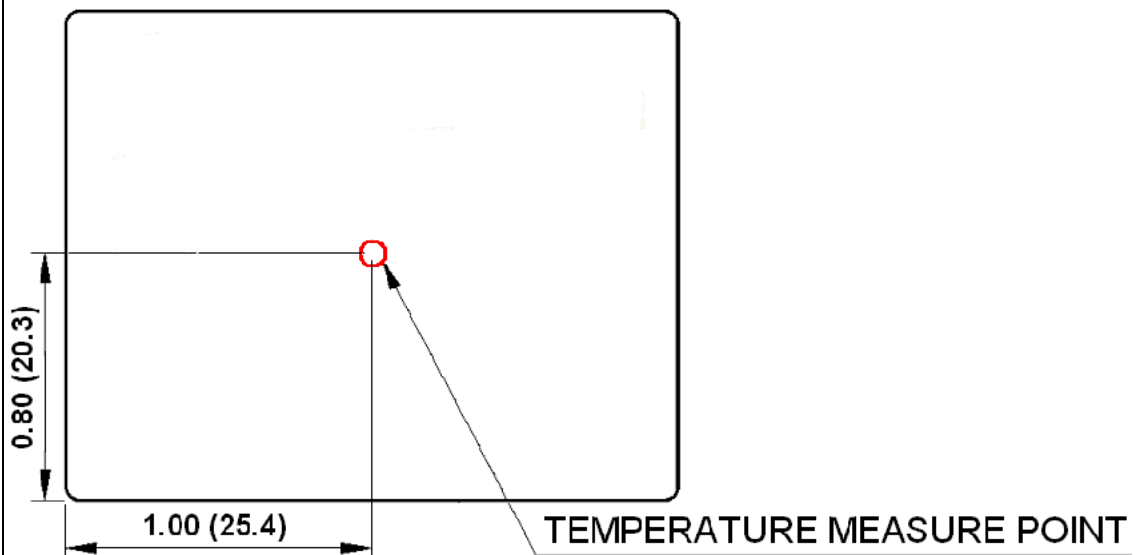

### Heat Sink Consideration

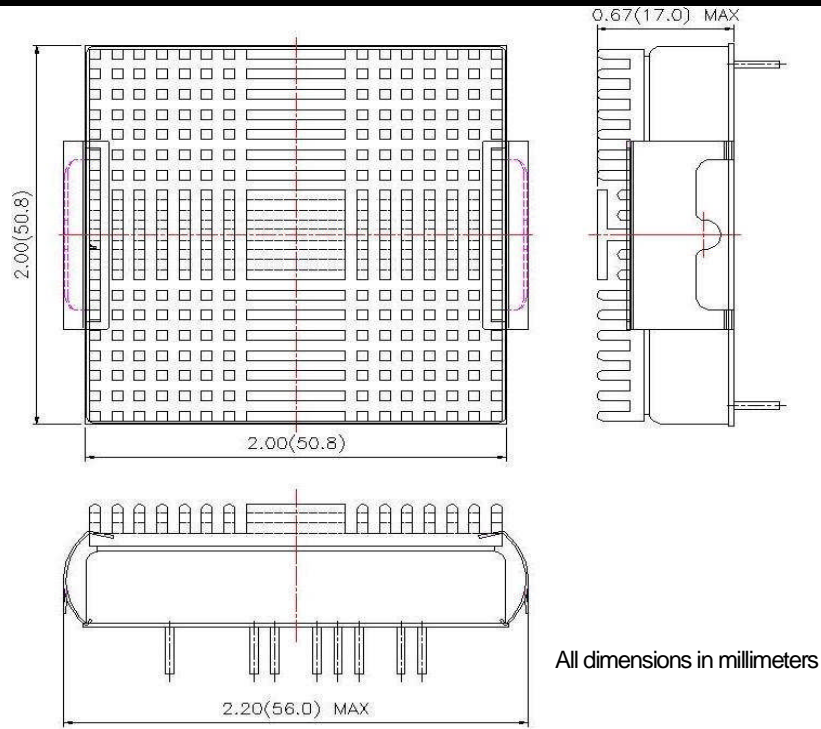

Use heat-sink (7G-0026A) for lowering temperature and higher reliability of the module.

Remote ON/OFF Control

The Remote ON/OFF Pin is used to turn on and off the DC-DC converter. The user must use a switch to control the logic voltage (high or low level) of the ON/OFF pin, referenced to  $V_i (-)$ . The switch can be a open collector transistor, FET, or Opto-Coupler, that is capable of sinking up to 0.5 mA at a low-level logic Voltage. For high-level logic of the ON/OFF signal (maximum voltage): the allowable leakage current of the switch at 12V is 0.5 mA.

Remote ON/OFF Implementation Circuits

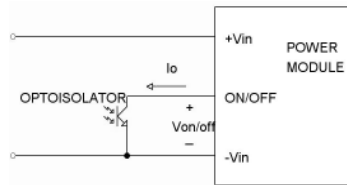

Isolated-Control Remote ON/OFF

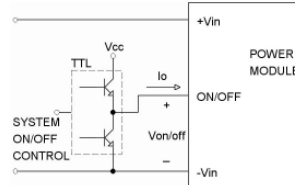

Level Control Using TTL Output

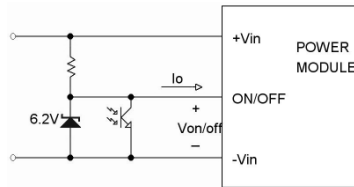

Level Control Using Line Voltage

Positive logic:

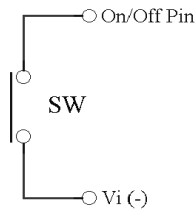

PXF40 module is turned off using Low-level logic

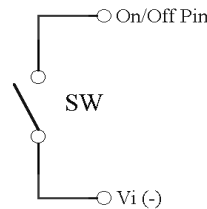

PXF40 module is turned on using High-level logic

Mechanical Data

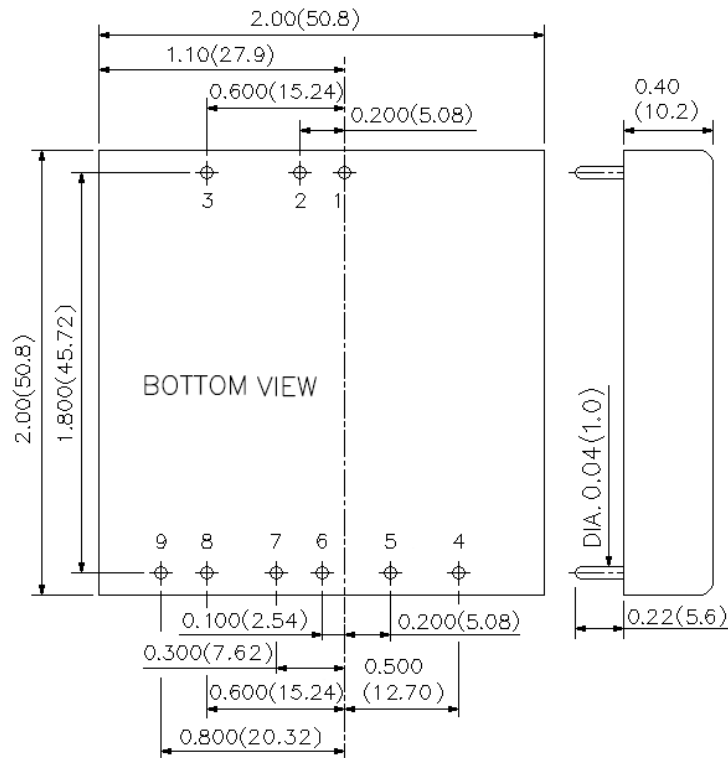

1. All dimensions in Inches (mm)  
Tolerance: X.XX±0.02 (X.X±0.5)  
X.XXX±0.01 (X.XX±0.25)
2. Pin pitch tolerance ±0.01(0.25)
3. Pin dimension tolerance ±0.004 (0.1)

PIN CONNECTION	
PIN	FUNCTION
1	+INPUT
2	-INPUT
3	CTRL
4	+AUX
5	COMMON
6	-AUX
7	+OUTPUT
8	COMMON
9	NC

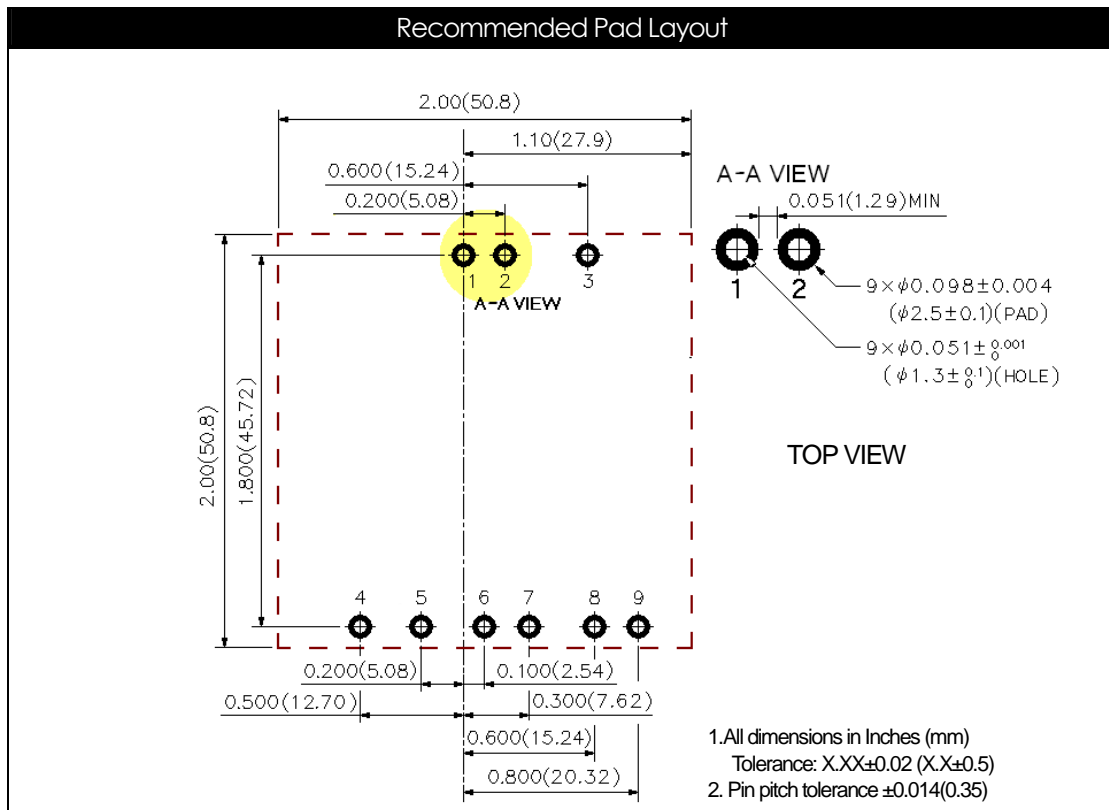

Soldering and Reflow Consideration

Lead free wave solder profile for PXF40xxTxxxx DIP type

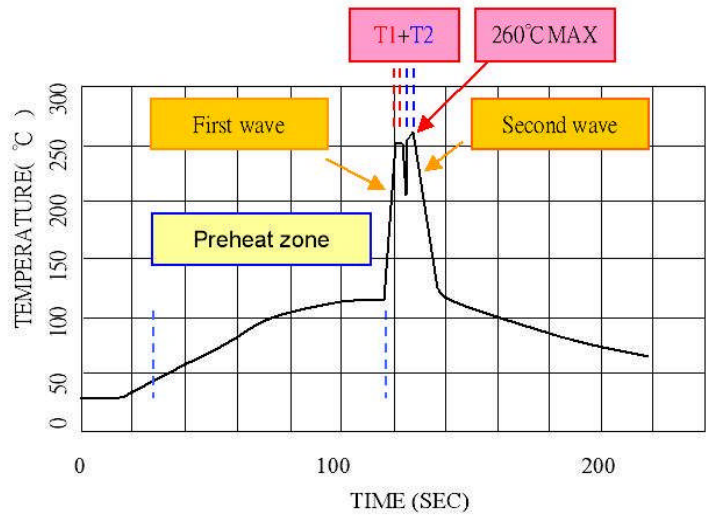

Zone	Reference Parameter
Preheat zone	Rise temp. speed : 3°C □/ sec max. Preheat temp. : 100~130°C
Actual heating	Peak temp. : 250~260°C□ Peak time (T1+T2 time) : 4~6 sec

**Reference Solder:** Sn-Ag-Cu/ Sn-Cu

**Hand Welding:** Soldering iron -Power 90W

Soldering Time -2 to 4 sec

Temp.:380 - 400°C

Packaging Information

10 PCS per TUBE

Part Number Structure

PXF 40 - 48 T 0512

Max. Output Power  
40 Watts

Input Voltage Range  
12 : 9 ~ 18 V  
24 : 18 ~ 36 V  
48 : 36 ~ 75 V

Triple Output

Output Voltage	
3312	: 3.3 / ±12Vdc
3315	: 3.3 / ±15Vdc
0512	: 5 / ±12Vdc
0515	: 5 / ±15Vdc

Model Number	Input Range	Output Voltage	Output Current		Input Current		Eff <sup>(3)</sup> (%)
			Min. load	Full Load	No load <sup>(1)</sup>	Full Load <sup>(2)</sup>	
PXF40-12T3312	9 - 18 VDC	3.3 / ±12 VDC	600mA / ±40mA	6000mA / ±400mA	215mA	3063mA	84
PXF40-12T3315	9 - 18 VDC	3.3 / ±15 VDC	600mA / ±30mA	6000mA / ±300mA	230mA	3000mA	84
PXF40-12T0512	9 - 18 VDC	5 / ±12 VDC	600mA / ±40mA	6000mA / ±400mA	280mA	4024mA	86
PXF40-12T0515	9 - 18 VDC	5 / ±15 VDC	600mA / ±30mA	6000mA / ±300mA	255mA	3963mA	86
PXF40-24T3312	18 - 36 VDC	3.3 / ±12 VDC	600mA / ±40mA	6000mA / ±400mA	65mA	1512mA	85
PXF40-24T3315	18 - 36 VDC	3.3 / ±15 VDC	600mA / ±30mA	6000mA / ±300mA	65mA	1481mA	85
PXF40-24T0512	18 - 36 VDC	5 / ±12 VDC	600mA / ±40mA	6000mA / ±400mA	60mA	1989mA	87
PXF40-24T0515	18 - 36 VDC	5 / ±15 VDC	600mA / ±30mA	6000mA / ±300mA	75mA	1958mA	87
PXF40-48T3312	36 - 75 VDC	3.3 / ±12 VDC	600mA / ±40mA	6000mA / ±400mA	35mA	747mA	86
PXF40-48T3315	36 - 75 VDC	3.3 / ±15 VDC	600mA / ±30mA	6000mA / ±300mA	35mA	732mA	86
PXF40-48T0512	36 - 75 VDC	5 / ±12 VDC	600mA / ±40mA	6000mA / ±400mA	30mA	982mA	88
PXF40-48T0515	36 - 75 VDC	5 / ±15 VDC	600mA / ±30mA	6000mA / ±300mA	40mA	967mA	88

Note 1. Typical value at nominal input voltage and no load.

Note 2. Maximum value at nominal input voltage and full load of standard type.

Note 3. Typical value at nominal input voltage and full load.



**Safety and Installation Instructions****Fusing Consideration**

Caution: This converter is not internally fused. An input line fuse must always be used.

This encapsulated converter can be used in a wide variety of applications, ranging from simple stand-alone operation to an integrated part of a sophisticated power architecture. For maximum flexibility, internal fusing is not included; however, to achieve maximum safety and system protection, always use an input line fuse. The safety agencies require a slow-blow fuse with maximum rating of 8A. Based on the information provided in this data sheet on inrush energy and maximum DC input current; the same type of fuse with a lower rating can be used. Refer to the fuse manufacturer's data for further information.

**MTBF and Reliability****The MTBF of PXF40-xxT-xxxx triple output DC/DC converters has been calculated using**

Bellcore TR-NWT-000332 Case I: 50% stress, Operating Temperature at 40°C (Ground fixed and controlled environment ). The resulting figure for MTBF is  $1.398 \times 10^6$  hours.

MIL-HDBK-217F NOTICE2 FULL LOAD, Operating Temperature at 25°C °C. The resulting figure for MTBF is  $3.585 \times 10^5$  hours.