

**PHYSICAL DIMENSIONS:**

A	14.48 [.570]	+ .23 [.009]
B	10.03 [.395]	+ .15 [.006]
C	9.78 [.385]	- .15 [.006]
C1	10.90 [.429]	+ .23 [.009] - .59 [.023]
D	4.06 [.160]	+ .13 [.005]
E	2.54 [.100]	+ .13 [.005]
E1	3.45 [.136]	+ .13 [.005]
F	0.76 [.030]	+ .08 [.003]
T <sub>1</sub>	3.20 [.126]	+ .25 [.010]
T <sub>2</sub>	1.09 [.043]	REF.

# CM5740Z241B-10

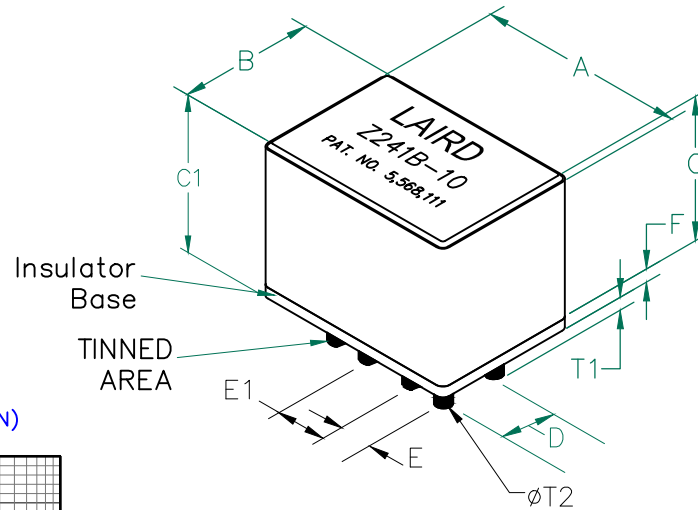

ELECTRICAL CHARACTERISTICS:			
Z @ 4 MHz (2-TURN) (Ω)	DCR (Ω) VALUE PER TURN	Rated Current	
Nominal	240		
Minimum	180		
Maximum	-	0.0013	20,000 mA

- NOTES: UNLESS OTHERWISE SPECIFIED
1. BULK PACKAGED, 825 PCS PER CASE.
  2. COMPONENTS SHOULD BE ADEQUATELY PREHEATED BEFORE SOLDERING.
  3. LINE TO LINE HI-POT: > 500 VDC.
  4. OPERATION TEMPERATURE (INCLUDING SELF-HEATING): -40 ~ +125°C.

Z vs. FREQUENCY (C,O,N) (2-TURN)

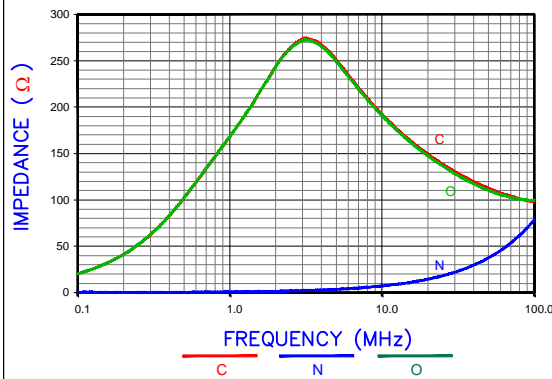

Z, R , XL vs. FREQUENCY (2-TURN)

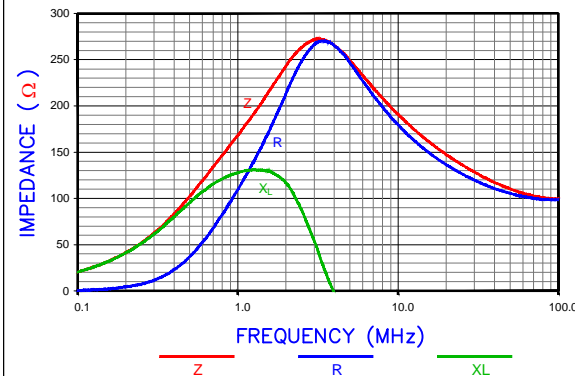

Two Turn Equivalent Circuits

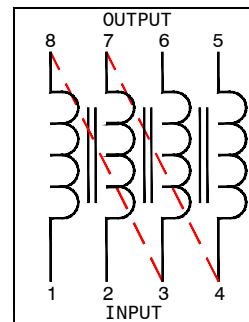

RoHS

HOLE PATTERNS FOR WAVE SOLDERING

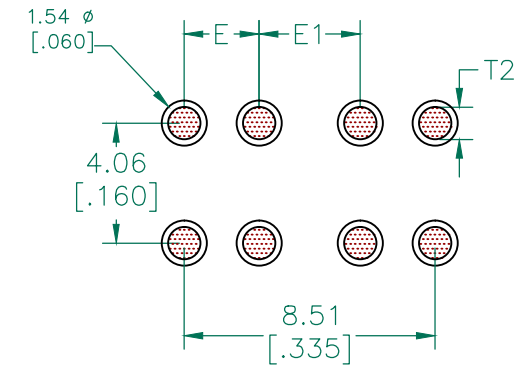

DIMENSIONS ARE IN mm (INCHES).				This print is the property of Laird Tech. and is loaned in confidence subject to return upon request and with the understanding that no copies shall be made without the written consent of Laird Tech. All rights to design or invention are reserved.			
F	CHANGE DIMENSIONS C1 AND NOTE 4	07/06/15	QU		REV	PART TYPE:	DRAWN BY:
E	UPDATE COMPANY LOGO & KAPTON LABEL	11/18/08	JRK		F	ASSEMBLY	JRK
D	ADD TWO LINES TO CENTER OF EQUIVALENT CIRCUIT DIAGRAM	04/16/07	JRK		PROJECT/PART NUMBER:	CM5740Z241B-10	
C	MOVE CURRENT RATING TO MAX.FROM MIN.	02/23/07	JRK		DATE:	02/10/04	SCALE: NTS SHEET: 1 of 2
B	RE-ACTIVATE PRINT ADD ROHS SYMBOL CHANGE NOTES REMOVE VIEW	01/03/06	JRK		CAD #	H0571	
A	ORIGINAL DRAFT	02/10/04	JRK				
REV	DESCRIPTION	DATE	INT				

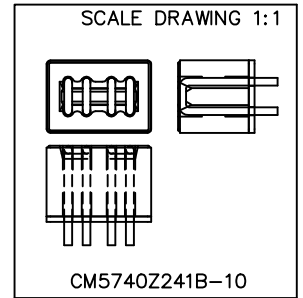
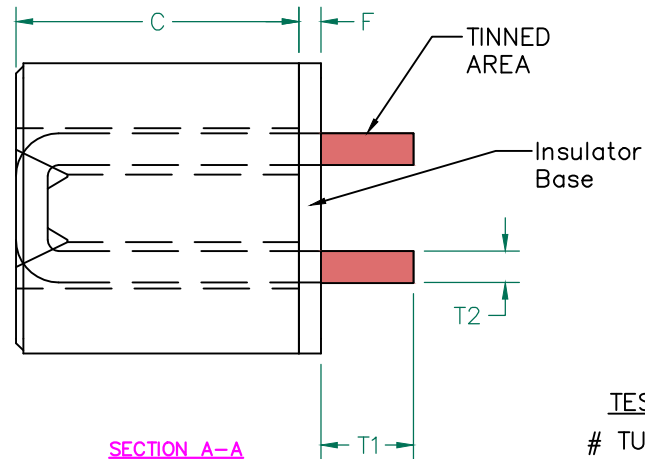
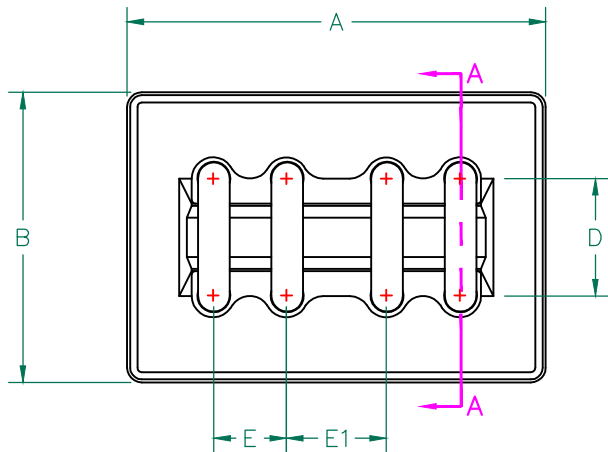

ELECTRICAL TESTING

TEST:	GROSS
# TURNS	2
AWG	22
FREQUENCY	4 MHz
NOMINAL	240 Ω
MINIMUM	180 Ω
WEIGHT/1000	5.39 kgs. 11.87 lbs.



NOTES: UNLESS OTHERWISE SPECIFIED

1. WIRE: REFERENCE STEWARD WIRE PURCHASE SPEC. WM040-61.
2. IMPEDANCE VALUES ARE GROSS, MEASURED USING WM040-61 WIRE PLACED AGAINST END OF SLOT w/ NO D.C. BIAS.
3. REFERENCE STEWARD CORE 35H0571-600.
4. LINE TO LINE HI-POT: > 500 VDC.
5. INSULATOR BASE: REF. PART NUMBER: BP5740-030.

DIMENSIONS:

A	14.48 [.570]	+	0.23 [.009]
B	10.03 [.395]	+	0.15 [.006]
C	9.32 [.385]	+	0.15 [.006]
C1	10.54 [.415]	+	0.23 [.009]
D	4.06 [.160]	+	0.13 [.005]
E	2.54 [.100]	+	0.13 [.005]
E1	3.45 [.136]	+	0.13 [.005]
F	0.76 [.030]	+	0.08 [.003]

WIRE DIMENSIONS:

T1	3.20 [.126]	+	0.25 [.010]
T2	1.09 [.043]		REF.

DIMENSIONS ARE IN mm (INCHES).				This print is the property of Laird Tech. and is loaned in confidence subject to return upon request and with the understanding that no copies shall be made without the written consent of Laird Tech. All rights to design or invention are reserved.				
REV	DESCRIPTION	DATE	INT					PROJECT/PART NUMBER:
F	CHANGE DIMENSIONS C1 AND NOTE 4	07/06/15	JRK	CM5740Z241B-10		F	ASSEMBLY	JRK
E	UPDATE COMPANY LOGO & KAPTON LABEL	11/18/08	JRK	DATE:	02/10/04	SCALE:	NTS	SHEET:
D	ADD TWO LINES TO CENTER OF EQUIVALENT CIRCUIT DIAGRAM	04/16/07	JRK	CAD #	CM5740Z241B-10-F-2	TOOL #	H0571	2 of 2
C	MOVE CURRENT RATING TO MAX.FROM MIN.	02/23/07	JRK					
B	RE-ACTIVATE PRINT ADD ROHS SYMBOL CHANGE NOTES REMOVE VIEW	01/03/06	JRK					
A	ORIGINAL DRAFT	02/10/04	JRK					
REV	DESCRIPTION	DATE	INT					