

## Data sheet | Item number: 890-627

T-distribution connector; 4-pole; Cod. A; 1 input; 2 outputs; 3 locking levers;  
for flying leads; black

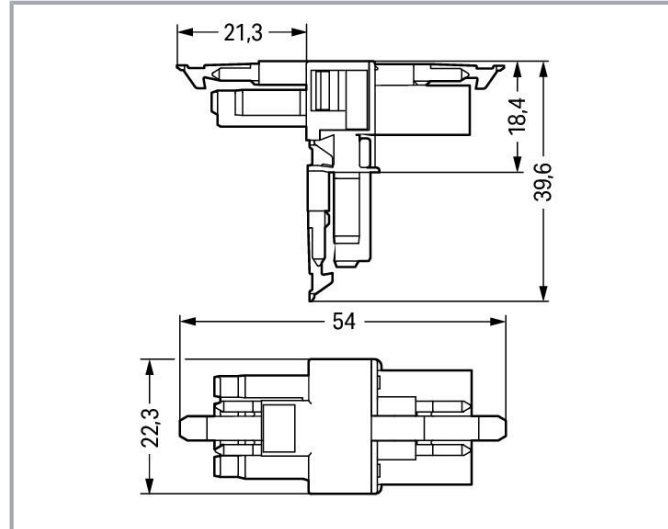

[www.wago.com/890-627](http://www.wago.com/890-627)



### Item description

#### Distribution connector *WINSTA*® MINI with protection against mismatching

For signal and power transmission: The *WINSTA*® MINI distribution connector with protection against mismatching. On PCBs, in control cabinets or for connecting lights – pluggable installation connectors from WAGO allow you to establish connections according to various requirements in seconds. The coding options reduce installation errors, allowing fast, maintenance-free wiring of all components. Thanks to the color coding and mechanical A coding of *WINSTA*® MINI pluggable installation connectors, you can clearly distinguish different circuits. Particularly where space is tight, our smallest pluggable connection system, *WINSTA*® MINI, conveniently displays its advantageous properties. It saves space, and, thanks to Push-in CAGE CLAMP® spring pressure connection technology, it additionally saves time, since the connection is low-maintenance and can be performed without screw connections.

Subject to changes. Please also observe the further product documentation!

WAGO GmbH & Co. KG  
Hansastr. 27  
32423 Minden  
Phone: +49571 887-0 | Fax: +49571 887-169  
Email: [info.de@wago.com](mailto:info.de@wago.com) | Web: [www.wago.com](http://www.wago.com)

Do you have any questions about our products?  
We are always happy to take your call at +49 (571) 887-44222.



## Push-in CAGE CLAMP® spring pressure connection technology – pluggable installation instead of laborious screw connections!

WINSTA® is the pluggable connection system that is perfectly tailored to the strict requirements of electrical installation. It allows fast, secure and, above all, error-free installation of components and cables. Choose durability and quality – the WINSTA® MINI pluggable installation connector with marking from WAGO makes the installation of electrical components significantly easier.

- pluggable installation connectors with protection against mismatching
- consistent IP40 protection
- with A coding for a great number of uses
- ready to install and use immediately
- quick replacement of defective units during ongoing operation

### Data

#### Electrical data

#### Ratings per IEC/EN

Ratings per	IEC/EN 60664-1
Nominal voltage (III/3)	400 V
Rated impulse voltage (III/3)	6 kV
Rated current	16 A
Legend (ratings)	(III / 3) ≙ Overvoltage category III / Pollution degree 3

#### Ratings per UL 1977

Note for the US market	Some versions may also be used for current interruption in accordance with the UL certificate in select applications with currents below 5 A and voltages up to 600 V. For further information, please contact your local sales office.
Rated voltage (UL 1977)	600 V
Rated current UL 1977	12 A

#### General

Note on contact resistance	approx. 1 mΩ of contact resistance approx. 0.25 mΩ contact transition plug/socket
----------------------------	--

Subject to changes. Please also observe the further product documentation!



## Connection data

Total number of potentials	4
PE function	Preceding PE contact

## Connection 1

Pole number	4
-------------	---

## Physical data

Pin spacing	4.4 mm / 0.173 inches
Width	22.3 mm / 0.878 inches
Height	39.6 mm / 1.559 inches
Depth	54 mm / 2.122 inches

## Mechanical Data

Application	General mains applications
Coding	A
Variable coding	No
Marking	N $\perp$ 2/L 1/L'
Potential marking	N $\perp$ 2/L 1/L'
Mating force of a plug-in connection	approx. 20 ... 70 N (depending on pole number)
Retention force of a plug-in connection	When locked: > 80 N
Unmating force of a plug-in connection	Unlocked: approx. 20 ... 70 N (depending on pole number)
Number of mating cycles	200, without resistive load
Type of distribution box	T-distribution connector
Protection type	IP20; IP40 when mated
Suitable	for flying leads

## Plug-in connection

Contact type (pluggable connector)	Socket/plug
Mismating protection	Yes
Note on mismating protection	All <b>WINSTA</b> <sup>®</sup> components are 100% protected against mismating when: a.) plugging different numbers of poles b.) plugging while rotated 180 c.) plugging while laterally staggered d.) plugging one pole

Subject to changes. Please also observe the further product documentation!



Locking lever	yes
Locking of plug-in connection	locking lever
Note on locking system	All connectors for mounted installations (snap-in versions for lighting fixtures or devices, all types of PCB and distribution connectors) are factory-equipped with locking levers to ensure plugs and sockets are securely locked. Additional locking levers are only required for flying leads (plug/socket).

## Material Data

Note (material data)	Information on material specifications can be found here
Color	black
Material group	I
Insulation material	Polyamide (PA66)
Flammability class per UL94	V0
Contact material	Copper or copper alloy; surface-treated
Contact plating	Tin
Fire load	0.212 MJ
Weight	10.6 g

## Environmental requirements

Processing temperature	-5 ... +40 °C
Continuous operating temperature	-35 ... +85 °C
Note on continuous operating temperature	Insulating parts for temperatures ≤ 105 °C

## Commercial data

Product Group	20 (Winsta)
eCl@ss 10.0	27-44-06-03
eCl@ss 9.0	27-44-06-03
ETIM 8.0	EC002567
ETIM 7.0	EC002567
PU (SPU)	25 pcs
Packaging type	box
Country of origin	DE
GTIN	4050821229537
Customs tariff number	85366990990

Subject to changes. Please also observe the further product documentation!

WAGO GmbH & Co. KG  
 Hansastr. 27  
 32423 Minden  
 Phone: +49571 887-0 | Fax: +49571 887-169  
 Email: [info.de@wago.com](mailto:info.de@wago.com) | Web: [www.wago.com](http://www.wago.com)

Do you have any questions about our products?  
 We are always happy to take your call at +49 (571) 887-44222.

## Environmental Product Compliance

RoHS Compliance Status



Compliant, No Exemption

## Approvals / Certificates



### General approvals

Logo	Approval	Additional Approval Text	Certificate name
	CCA DEKRA Certification B.V.	EN 61535	71- 123231
	CCA DEKRA Certification B.V.	IEC 61535	NL-85020
	cURus Underwriters Laboratories Inc.	UL 1977	E45171

### Declarations of conformity and manufacturer's declarations

Logo	Approval	Additional Approval Text	Certificate name
	EU-Declaration of Conformity WAGO GmbH & Co. KG	-	-
	UK-Declaration of Conformity WAGO GmbH & Co. KG	-	-

### Approvals for marine applications

Logo	Approval	Additional Approval Text	Certificate name
	ABS American Bureau of Shipping	Steel Vessel Rules	19- HG1869855- PDA
	DNV GL Det Norske Veritas, Germanischer Lloyd	-	TAE00001Z6
	LR	EN 61535	08/20047

Subject to changes. Please also observe the further product documentation!

WAGO GmbH & Co. KG  
 Hansastr. 27  
 32423 Minden  
 Phone: +49571 887-0 | Fax: +49571 887-169  
 Email: [info.de@wago.com](mailto:info.de@wago.com) | Web: [www.wago.com](http://www.wago.com)







Do you have any questions about our products?  
 We are always happy to take your call at +49 (571) 887-44222.



Lloyds Register

(E2)

## Counterpart

	<b>Item no.890-104</b> Socket; with strain relief housing; 4-pole; Cod. A; 1,50 mm <sup>2</sup> ; black	<a href="http://www.wago.com/890-104">www.wago.com/890-104</a>
	<b>Item no.890-114</b> Plug; with strain relief housing; 4-pole; 1,50 mm <sup>2</sup> ; black	<a href="http://www.wago.com/890-114">www.wago.com/890-114</a>
	<b>Item no.890-214</b> Plug; 4-pole; Cod. A; 1,50 mm <sup>2</sup> ; black	<a href="http://www.wago.com/890-214">www.wago.com/890-214</a>
	<b>Item no.890-204</b> Socket; 4-pole; Cod. A; 1,50 mm <sup>2</sup> ; black	<a href="http://www.wago.com/890-204">www.wago.com/890-204</a>
	<b>Item no.891-8994/106-101</b> pre-assembled connecting cable; Eca; Socket/open-ended; 4-pole; Cod. A; H05VV-F 4G 1.5 mm <sup>2</sup> ; 1 m; 1,50 mm <sup>2</sup> ; black	<a href="http://www.wago.com/891-8994/106-101">www.wago.com/891-8994/106-101</a>
	<b>Item no.891-8994/006-101</b> pre-assembled interconnecting cable; Eca; Socket/plug; 4-pole; Cod. A; H05VV-F 4G 1.5 mm <sup>2</sup> ; 1 m; 1,50 mm <sup>2</sup> ; black	<a href="http://www.wago.com/891-8994/006-101">www.wago.com/891-8994/006-101</a>
	<b>Item no.891-8994/206-101</b> pre-assembled connecting cable; Eca; Plug/open-ended; 4-pole; Cod. A; H05VV-F 4G 1.5 mm <sup>2</sup> ; 1 m; 1,50 mm <sup>2</sup> ; black	<a href="http://www.wago.com/891-8994/206-101">www.wago.com/891-8994/206-101</a>

## Downloads

### Documentation

#### Bid Text

890-627 X81 - Datei	2019 Feb 19	xml 2.9 kB	Download
890-627 doc - Datei	2014 Dec 3	doc 23.0 kB	Download

## CAD/CAE-Data

### CAE data

WSCAD Universe 890-627	URL	Download
------------------------	-----	----------

Subject to changes. Please also observe the further product documentation!

WAGO GmbH & Co. KG  
Hansastr. 27  
32423 Minden  
Phone: +49571 887-0 | Fax: +49571 887-169  
Email: [info.de@wago.com](mailto:info.de@wago.com) | Web: [www.wago.com](http://www.wago.com)

Do you have any questions about our products?  
We are always happy to take your call at +49 (571) 887-44222.

## Environmental Product Compliance

### Compliance Search

Environmental Product Compliance 890-627

URL

Download

T-distribution connector; 4-pole; Cod. A; 1 input; 2 outputs; 3 locking levers; for flying leads; black

---

## Installation Notes

### Installation

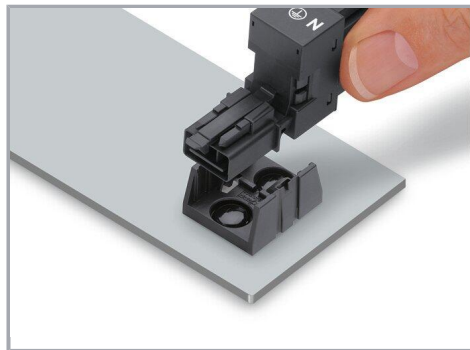

Secure the mounting plate via pins.

## Product family

**WINSTA® MINI**

[Show all products from the family](#)

Subject to changes. Please also observe the further product documentation!